

DORMER  PRAMET

MILLING

2021 – 2022



 **DORMER**

 **PRAMET**

**MILLING – GENERAL CONTENT**

6		WMG & ISO 13399
10	SOLID MILLS	INSTRUCTIONS
19		HM MILLS
117		HSS-E-PM, HSS-E, HSS MILLS
201		TECHNICAL INFORMATION
212		ROTARY BURRS
292		THREAD MILLS
314	INDEXABLE MILLS	INSTRUCTIONS
328		NAVIGATORS
349		FACE MILLS
409		SQUARE SHOULDER MILLS
479		DEEP SHOULDER MILLS
508		SLOT MILLS
521		COPY MILLS
613		HIGH FEED MILLS (HFC)
645		CHAMFER & T-SLOT MILLS
667		OTHER INSERTS
691		TECHNICAL INFORMATION



PRODUCT FAMILY		PRODUCT FAMILY		PRODUCT FAMILY		PRODUCT FAMILY	
C		J		P831		S765	
C110	126	J200	299	P833	268	S765HB	38
C122	144	J205	300	P835	269	S766	39
C123	130	J210	301	P837	270	S767	40
C126	128	J215	302	P841	271	S768	41
C135	133	J220	303	P842	272	S770HB	42
C139	132	J225	304	P843	273	S771HB	43
C159	141	J235	305	P844	283	S772HB	44
C167	143	J245	306	P880	284	S773HB	45
C246	151	J260	308	P890	287	S791	46
C247	149	J280	307	S		S802HA	47
C273	152	P		S216	50	S802HB	88
C295	154	P100	285	S217	51	S803HA	89
C299	146	P101	286	S218	52	S803HB	93
C305	138	P501	274	S219	53	S804HA	94
C306	134	P505	275	S225	54	S804HB	98
C333	155	P507	276	S226	55	S812HA	99
C336	142	P509	277	S227	56	S812HB	90
C346	145	P511	278	S229	57	S813HA	91
C352	140	P513	279	S231	58	S813HB	95
C353	135	P515	280	S233	59	S813HA	96
C367	137	P521	281	S260	60	S814HA	100
C400	162	P523	282	S262	61	S814HB	101
C403	164	P601	260	S264	63	S822	92
C407	159	P605	261	S501	102	S823	97
C413	163	P607	262	S511	103	S902	104
C428	157	P609	263	S521	64	S903	106
C492	158	P611	264	S523	65	S904	108
C500	165	P613	265	S524	66	S922	105
C505	166	P615	266	S525	67	S933	107
C700	176	P621	267	S526	68	S944	109
C710	175	P701	251	S527	69	S991	110
C800	167	P703	252	S529	70		
C801	170	P705	253	S531	71		
C810	168	P707	254	S533	72		
C820	178	P709	255	S534	73		
C822	177	P711	256	S535	74		
C825	169	P713	257	S536	75		
C830	173	P715	258	S561	76		
C831	174	P721	259	S610	77		
C835	172	P801	230	S611	79		
C837	171	P801C	231	S612	80		
C907	147	P803	232	S614	87		
C908	160	P803C	233	S629	81		
C920	148	P805	234	S637	82		
C922	156	P805C	235	S638	78		
C948	161	P807	236	S650	83		
D		P807C	237	S654	84		
D200	180	P809	238	S662	85		
D400	190	P811	239	S710	86		
D402	192	P811C	240	S713	28		
D420	191	P813	241	S714	29		
D422	193	P813C	242	S715	30		
D745	182	P815	243	S716	31		
D747	184	P815C	244	S717	32		
D750	188	P817	245	S718	33		
D751	189	P819	246	S718	34		
D752	186	P821	247	S722HB	35		
D753	187	P821C	248	S739	48		
D763	181	P823	249	S740	49		
		P825	250	S761	36		
				S763	37		



PRODUCT FAMILY	
2	
2516	654
2636	657
C	
CHN09	401
FSB22X	405
F-SCC	664
FTB27X	475
J	
J(T)-2416	503
J(T)-CSD12X	505
J(T)-SAD11E	482
J(T)-SAD16E	488
J(T)-SLSN	494
J(T)-SSAP	498
J(T)-SXP16	660
K	
K2-PPH	592
K2-SLC	588
K2-SRC	579
K3-CXP	575
L	
L2-SZP	568
N	
N-SS009	651
S	
S90CN(XN)	516
S90SN	510
SAD07D	413
SAD11E	420
SAD16E	429
SAP10D	438
SAP16D	441
SBN10	616
SCN05C	610
SHN06C	352
SHN09C	356
SLN12	455
SLN16	461
SOD05	360
SOD06D	370
SOE06Z	376
SOE09Z	383
SPD09	627
SPN13	397
SRC10	526
SRC12	530
SRC16	534
SRC20	538
SRD05	542
SRD07	545
SRD10	550
SRD12	556
SRD16	562
SSD09	648
SSD12	472
SSE09	389
SSN11	622
SSN12Z	393
SSO050	466
SSO09	469

PRODUCT FAMILY	
STN10	446
STN16	450
SVC22C	604
SWN04C	607
SZD07	633
SZD09	637
SZD12	641



PRODUCT FAMILY		PRODUCT FAMILY		PRODUCT FAMILY	
A		PNMU 13	398	SNET 13	496
ADEX 07-FA	416	PPH	594	SNGX 11	623
ADEX 07-HF	415	PPHF	595	SNGX 13	495
ADEX 11-FA	425, 485	PPHT	595	SNHF	680
ADEX 11-HF	424	R		SNHN	681
ADEX 16	432, 491	RC	580	SNHQAZ	512
ADEX 16-FA	434, 491	RCMT 10	527	SNHQTRL	513
ADEX 16-HF	433	RCMT 12	531	SNKT 12	395
ADKT 15	670	RCMT 16	535	SNKX	681
ADKX 15	670	RCMT 20	539	SNMT 12	394
ADMX 07	414	RDET	673	SNUN	682
ADMX 11	422, 483	RDEX	674	SOMT 05	467
ADMX 16	430, 489	RDGT 07	546	SOMT 09	470, 652
ANHX 10	618	RDGT 10	552	SPET 12	500
APET 15	499	RDGT 12	558	SPET 12 AD	500
APET 16-FA	443	RDGT 12IM	362	SPEW 12 AD	501
APEW 15	499	RDGT 16	564	SPGN	682
APKT 10	439	RDHT 07-FA	547	SPGN 25 DZ	683
APKT 10-FA	439	RDHT 10-FA	552	SPKN	683
APKT 16	442	RDHT 12-FA	558	SPKR	684
APMT 16	671	RDHT 16-FA	564	SPKX	685
B		RDHX 05	543	SPUN	685
BNGX 10	617	RDHX 07	546	T	
C		RDHX 10	551	TBMR 27	476
CCMX	665	RDHX 12	557	TCMT	655, 658
CNHQ	518	RDHX 16	563	TNGX 10	447
CNHX 05	611	RDHX 20	674	TNGX 10-FA	448
CNM	672	RDMT 07	547	TNGX 16	451
H		RDMT 10	553	TNGX 16-FA	452
HNEF 09	402	RDMT 12	559	TNJF	686
HNGX 06	353	RDMT 12IM	363	TPCN 16	687
HNGX 09	357	RDMT 16	565	TPKN	687
HNMF 09	403	RDMX 10	551	TPKR	688
L		RDMX 12	557	TPUN	689
LC	581, 589	RDMX 16	563	V	
LC 12-CH	582	REHT 16	379	VCGT 22-FA	611, 690
LC 12-RE	583	REHT 24	385	W	
LNET 16	495	RPET 12	675	WNHX 04	608
LNGU 12	458	RPET 15	372	X	
LNGU 16	463	RPEW 12	675	XDHW	690
LNGU 16-FA	464	RPEW 15	373	XEHT 06	378
LNGX 12	456	RPEX	676	XEHT 09	385
LNGX 12-FA	458	S		XNGX 06	354
LNMU 16	462	SBKX 22	406	XNGX 09	358
O		SBMR 22	406	XNGX 13	399
ODEW 06	371	SDEW 09	649	XNHQ	518
ODKT 05IM	361	SDEX 09	649	XP	576
ODMT 05	672	SDGX 12	506	XPHT 16	661
ODMT 05IM	362	SDKT 12IM	364	XPHT 16-FA	662
ODMT 06	371	SDMT 12	473	Z	
ODMX 06	372	SDMT 12IM	364	ZDCW 07	634
OEHT 06	377	SDMX 12	506	ZDCW 09	638
OEHT 06-FA	378	SEEN	676	ZDEW 12	642
OEHT 09	384	SEER	677	ZP	570
OFKR 07	673	SEET 09	390		
P		SEET 12	678		
PKKT 09	630	SEET 12-FA	678		
PDKX 09	628	SEET 12-PM	679		
PDMW 09	630	SEEW 12	679		
PDMX 09	629	SEMT 09	391		
PNMQ 13	398	SFCN	680		



DORMER PRAMET



EVERY APPLICATION

Whether you are hole-making, milling, turning or threading, every application is covered within our machining calculator app. Download it today from your relevant app store. **Simply Reliable.**

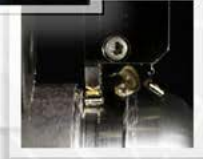
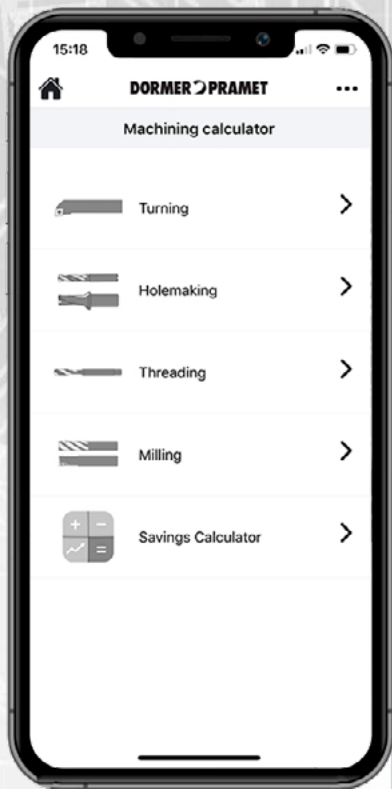



WORKPIECE MATERIAL GROUPS (WMG)

ISO To select a cutting grade and geometry for a broad range of workpiece materials

General definition
i.e. Steel, Stainless Steel...

P **M** **K** **N** **S** **H**

Subgroup To navigate and select a tool by suitability for a more specific range of workpiece materials

Definition by structure/composition
i.e. Plain Carbon Steel, Alloy Steel...

P **M** **K** **N** **S** **H**

P1

P2

P3

P4

WMG To select and provide cutting conditions within a bandwidth of $\pm 10\%$

Definition by hardness/ultimate tensile strength
i.e. $160 < 220 \text{ HB}$, $620 < 900 \text{ N/mm}^2 \dots$

P

P1 **P1.1** **P1.2** **P1.3**

P2 **P2.1** **P2.2** **P2.3**

P3 **P3.1** **P3.2** **P3.3**

P4 **P4.1** **P4.2** **P4.3**

ABOUT DORMER PRAMET'S WORKPIECE MATERIAL CLASSIFICATION

Workpiece **Material Groups (WMG)** are used to support easy and reliable selection of the right cutting tool and starting values for machining conditions in particular applications.

Dormer Pramet classifies workpiece materials into six different coloured groups;

- **Blue:** Steel and cast steel (P-group)
- **Yellow:** Stainless steel (M-group)
- **Red:** Cast iron (K-group)
- **Green:** Non-ferrous metals (N-group)
- **Brown:** High-temperature alloys (S-group)
- **Grey:** Hardened materials (H-group)

Each of these are divided into subgroups on the basis of their structure and/or composition. For example, P-group steel and cast steel is split into four subgroups, namely;

- **P1** – Free machining steel
- **P2** – Plain carbon steel
- **P3** – Alloy steel
- **P4** – Tool steel

A final division includes material properties, such as hardness and ultimate tensile strength. This is to provide our customers with a complete tool recommendation, including starting values for cutting speed and feed.

The table on the next page includes a description of each workpiece material group, as well as examples of commonly used designations.



WMG (WORK MATERIAL GROUP)

ISO group	WMG (Work Material Group)		Hardness (HB or HRC)	Ultimate Tensile Strength (MPa)				
P	P1	P1.1	Sulfurized	< 240 HB	≤ 830			
		P1.2	Free machining steel	Sulfurized and phosphorized	< 180 HB	≤ 620		
		P1.3	(carbon steels with increased machinability)	Sulfurized/phosphorized and leaded	< 180 HB	≤ 620		
	P2	P2.1	Plain carbon steel (steels comprised of mainly iron and carbon)	Containing <0.25 % C	< 180 HB	≤ 620		
		P2.2		Containing <0.55 % C	< 240 HB	≤ 830		
		P2.3		Containing >0.55 % C	< 300 HB	≤ 1030		
	P3	P3.1	Alloy steel (carbon steels with an alloying content ≤ 10%)	Annealed	< 180 HB	≤ 620		
		P3.2		Hardened and tempered	180 – 260 HB	> 620 ≤ 900		
		P3.3			260 – 360 HB	> 900 ≤ 1240		
	P4	P4.1	Tool steel (special alloy steel for tools, dies and molds)	Annealed	< 26 HRC	≤ 900		
P4.2		Hardened and tempered		26 – 39 HRC	> 900 ≤ 1240			
P4.3				39 – 45 HRC	> 1240 ≤ 1450			
M	M1	M1.1	Ferritic stainless steel (straight chromium non-hardenable alloys)	< 160 HB	≤ 520			
				160 – 220 HB	> 520 ≤ 700			
	M2	M2.1	Martensitic stainless steel (straight chromium hardenable alloys)	Annealed	< 200 HB	≤ 670		
				Quenched and tempered	200 – 280 HB	> 670 ≤ 950		
				Precipitation-hardened	280 – 380 HB	> 950 ≤ 1300		
	M3	M3.1	Austenitic stainless steel (chromium-nickel and chromium-nickel-manganese alloys)	< 200 HB	≤ 750			
				200 – 260 HB	> 750 ≤ 870			
				260 – 300 HB	> 870 ≤ 1040			
	M4	M4.1	Austenitic-ferritic (DUPLEX) or super-austenitic stainless steel	< 300 HB	≤ 990			
		M4.2	Precipitation hardening austenitic stainless steel	300 – 380 HB	≤ 1320			
K	K1	K1.1	Gray iron or Automotive Gray iron (GG) (iron-carbon castings with a lamellar graphite microstructure)	Ferritic or ferritic-pearlitic	< 180 HB	≤ 190		
				Ferritic-pearlitic or pearlitic	180 – 240 HB	> 190 ≤ 310		
				Pearlitic	240 – 280 HB	> 310 ≤ 390		
	K2	K2.1	Malleable iron (GTS/GTW) (iron-carbon castings with a graphite-free microstructure)	Ferritic	< 160 HB	≤ 400		
				Ferritic or pearlitic	160 – 200 HB	> 400 ≤ 550		
				Pearlitic	200 – 240 HB	> 550 ≤ 660		
	K3	K3.1	Ductile iron (GGG) (iron-carbon castings with a nodular graphite microstructure)	Ferritic	< 180 HB	≤ 560		
				Ferritic or pearlitic	180 – 220 HB	> 560 ≤ 680		
				Pearlitic	220 – 260 HB	> 680 ≤ 800		
	K4	K4.1	Austenitic gray iron (ASTM A436) (iron-carbon alloy castings with an austenitic lamellar graphite microstructure)	< 180 HB	≤ 190			
< 240 HB				≤ 740				
K4.2		Austenitic ductile iron (ASTM A439 or ASTM A571) (iron-carbon alloy castings with an austenitic nodular graphite microstructure)	< 280 HB	> 840 ≤ 980				
			280 – 320 HB	> 980 ≤ 1130				
			320 – 360 HB	> 1130 ≤ 1280				
K5	K5.1	Compacted graphite iron CGI (ASTM A842) (iron-carbon castings with a vermicular graphite structure)	Ferritic	< 180 HB	≤ 400			
			Ferritic-pearlitic	180 – 220 HB	> 400 ≤ 450			
			Pearlitic	220 – 260 HB	> 450 ≤ 500			
N	N1	N1.1	Commercially pure wrought aluminium	< 60 HB	≤ 240			
				N1.2	Wrought aluminium alloys	Half hard tempered	60 – 100 HB	> 240 ≤ 400
						Full hard tempered	100 – 150 HB	> 400 ≤ 590
	N2	N2.1	Cast aluminium alloys	< 75 HB	≤ 240			
				75 – 90 HB	> 240 ≤ 270			
				90 – 140 HB	> 270 ≤ 440			
	N3	N3.1	Free-cutting copper-alloys materials with excellent machining properties	–	–			
				N3.2	Short-chip copper-alloys with good to moderate machining properties	–	–	
						N3.3	Electrolytic copper and long-chip copper-alloys with moderate to poor machining properties	–
	N4	N4.1	Thermoplastic polymers	–	–			
N4.2				Thermosetting polymers	–	–		
					N4.3	Reinforced polymers or composites	–	–
N5	N5.1	Graphite	–	–				
			–	–				
S	S1	S1.1	Titanium or titanium alloys	< 200 HB	≤ 660			
				200 – 280 HB	> 660 ≤ 950			
				280 – 360 HB	> 950 ≤ 1200			
	S2	S2.1	Fe-based high-temperature alloys	< 200 HB	≤ 690			
				200 – 280 HB	> 690 ≤ 970			
	S3	S3.1	Ni-based high-temperature alloys	< 280 HB	≤ 940			
				280 – 360 HB	> 940 ≤ 1200			
	S4	S4.1	Co-based high-temperature alloys	< 240 HB	≤ 800			
240 – 320 HB				> 800 ≤ 1070				
H	H1	H1.1	Chilled cast iron	< 440 HB	–			
				< 55 HRC	–			
	H2	H2.1	Hardened cast iron	> 55 HRC	–			
				< 51 HRC	–			
	H3	H3.1	Hardened steel <55 HRC	51 – 55 HRC	–			
				55 – 59 HRC	–			
H4	H4.1	Hardened steel >55 HRC	> 59 HRC	–				
			–	–				



CUTTING TOOL PARAMETERS ACCORDING TO ISO 13399

All cutting tools are defined by a number of parameters according to the standard ISO 13399. This list contains all the parameters used in this catalogue and their definitions.

ISO 13399 is an international cutting tool information standard. It provides dimensions and parameters in a neutral format that is independent of any particular system or company nomenclature. When cutting tools are clearly defined according to a global standard, all types of software can process the electronic data more quickly, improving the quality of communication and helping to make the exchange of information run smoothly. Supporting a common language in our cutting tool descriptions this will assist system to system communication. It will save you a significant amount of time, providing an easier gathering of high-quality data across our 40,000 solid and indexable tools. By using an ISO 13399 compliant system, there will be no need to manually interpret data and key-enter it into your system.

EXAMPLES ONLY!

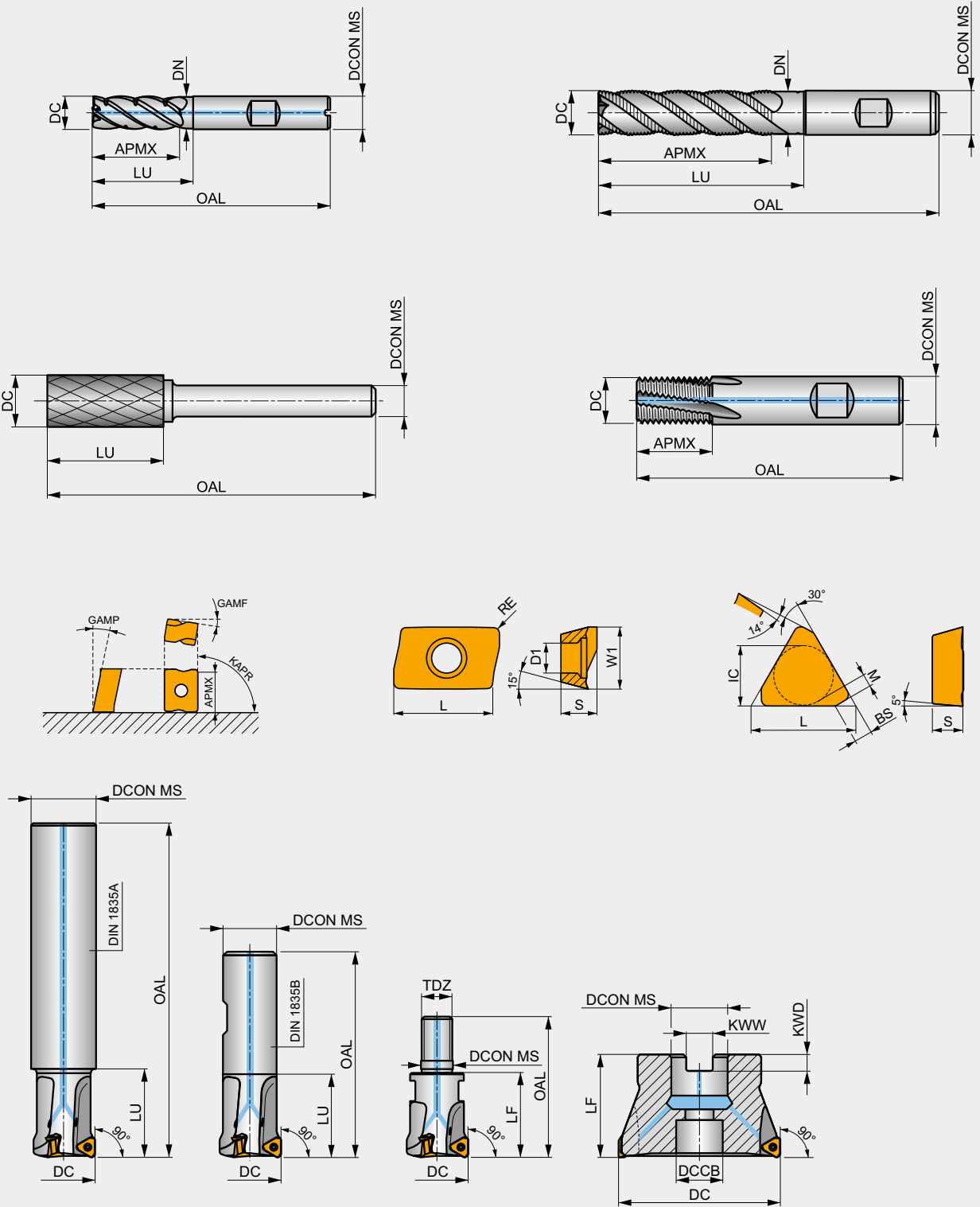



CUTTING TOOL PARAMETERS ACCORDING TO ISO 13399

ISO 13399 code	Description
APMX	Depth of cut maximum
BD	Body diameter
BDX	Body diameter maximum
BCH	Corner chamfer length
BS	Wiper edge length
CBDP	Connection bore depth
CDI	Insert cutting diameter
CDX	Cutting depth maximum
CW	Cutting width
CZC MS	Connection size code machine side
D1	Fixing hole diameter
DAH4	Diameter access hole
DAH5	Diameter access hole
DAH6	Diameter access hole
DBC1	Diameter bolt circle 1
DBC2	Diameter bolt circle 2
DBC4	Diameter bolt circle
DBC5	Diameter bolt circle
DBC6	Diameter bolt circle
DC	Cutting diameter
DCB	Connection bore diameter
DCCB	Counterbore diameter connection bore
DCN	Cutting diameter minimum
DCON MS	Connection diameter
DCX	Cutting diameter maximum
DHUB	Hub diameter
DN	Neck diameter
GAMF	Radial rake angle
GAMP	Axial rake angle

ISO 13399 code	Description
CHW	Corner chamfer width
IC	Inscribed circle diameter
INSD	Insert diameter
INSL	Insert length
KAPR	Tool cutting edge angle
KWD	Keyway depth
KWW	Keyway width
L	Cutting edge length
LB	Body length
LE	Cutting edge effective length
LF	Functional length
LH	Head length
LU	Usable length
LUX	Usable length maximum
M	M-dimension
NOF	Number of flutes
OAL	Overall length
P	Pitch of the blade
PRFA	Profile angle
PRFRAD(2)	Profile radius
RE	Radius
S	Insert thickness
S1	Insert thickness total
TDZ	Thread diameter size
TP	Thread pitch
TPI	Threads per inch
W1	Insert width
ZNP	Number of peripheral edges in the tool



**SOLID
HM & HSS MILLS**





MILLING – GENERAL CONTENT

6		WMG & ISO 13399
10	SOLID MILLS	INSTRUCTIONS
19		HM MILLS
117		HSS-E-PM, HSS-E, HSS MILLS
201		TECHNICAL INFORMATION
212		ROTARY BURRS
292		THREAD MILLS
314	INDEXABLE MILLS	INSTRUCTIONS
328		NAVIGATORS
349		FACE MILLS
409		SQUARE SHOULDER MILLS
479		DEEP SHOULDER MILLS
508		SLOT MILLS
521		COPY MILLS
613		HIGH FEED MILLS (HFC)
645		CHAMFER & T-SLOT MILLS
667		OTHER INSERTS
691		TECHNICAL INFORMATION



1 **C273**



Multi-Flute HSS-E-PM Long Series End Mill, Bright Finish

Long cut length, 4, 5 or 6 flute design provides high rigidity for **2** long deep profiles in mild steels and non-ferrous materials, such as aluminium and medium strength titanium alloys.

HSS-E PM	N	NOF 4-6
	λ 30°	γ 12°
DIN 1835B	Bright	DC k10
	DIN 844L	

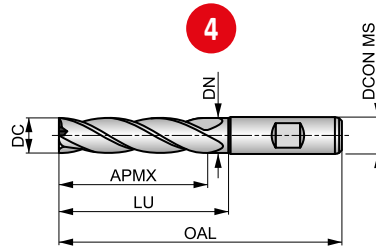

Workpiece material group suitability, starting values for cutting speed (m/min) and Alpha Code. Tables with feed per tooth and correction factors can be found starting from page 194.

P1.1 ■ 46 C	P1.2 ■ 52 C	P1.3 ■ 54 C	P2.1 ■ 40 C	P2.2 ■ 35 C	P3.1 ■ 32 C	P3.2 ■ 26 B	P4.1 ■ 19 B	M1.1 ■ 14 C	M1.2 ■ 12 C	M2.1 ■ 12 C	M2.2 ■ 10 B	K1.1 ■ 25 C	K1.2 ■ 19 C
K1.3 ■ 14 C	K2.1 ■ 49 C	K2.2 ■ 40 C	K2.3 ■ 32 B	K3.1 ■ 44 C	K3.2 ■ 33 C	K3.3 ■ 27 A	K4.1 ■ 40 B	K4.2 ■ 30 B	K4.3 ■ 22 B	K4.4 ■ 19 A	K4.5 ■ 16 A	K5.1 ■ 46 B	K5.2 ■ 34 B
K5.3 ■ 27 B	N1.1 ■ 81 E	N1.2 ■ 60 D	N1.3 ■ 41 D	N2.1 ■ 41 C	N2.2 ■ 37 C	N2.3 ■ 26 C	N3.1 ■ 43 C	N3.2 ■ 25 C	N3.3 ■ 13 C	N4.1 ■ 43 C	S1.1 ■ 25 B	S1.2 ■ 20 B	S2.1 ■ 13 A
S3.1 ■ 10 A	S4.1 ■ 8 A												

DCON MS tolerance h6.

Product	DC [inch]	DC [mm]	DCON MS [mm]	APMX [mm]	OAL [mm]	NOF	LU [mm]	DN [mm]
C2732.0	–	2.00	6.00	10.00	54.0	4	–	–
C2732.5	–	2.50	6.00	12.00	56.0	4	–	–
C2733.0	–	3.00	6.00	12.00	56.0	4	–	–
C2731/8²⁾	1/8	3.18	6.00	15.00	59.0	4	–	–
C2733.5	–	3.50	6.00	15.00	59.0	4	–	–
C2734.0	–	4.00	6.00	19.00	63.0	4	–	–
C2734.5	–	4.50	6.00	19.00	63.0	4	–	–
C2733/16²⁾	3/16	4.76	6.00	24.00	68.0	4	–	–
C2735.0	–	5.00	6.00	24.00	68.0	4	–	–
C2735.5	–	5.50	6.00	24.00	68.0	4	–	–
C2736.0	–	6.00	6.00	24.00	68.0	4	–	–
C2731/4²⁾	1/4	6.35	10.00	30.00	80.0	4	–	–
C2737.0	–	7.00	10.00	30.00	80.0	4	–	–
C2738.0	–	8.00	10.00	38.00	88.0	4	–	–
C2739.0	–	9.00	10.00	38.00	88.0	4	–	–
C2733/8²⁾	3/8	9.52	10.00	45.00	95.0	4	54.50	9.50
C27310.0	–	10.00	10.00	45.00	95.0	4	54.50	9.50
C27311.0	–	11.00	12.00	45.00	102.0	4	–	–
C27312.0	–	12.00	12.00	53.00	110.0	4	64.50	11.50
C2731/2²⁾	1/2	12.70	12.00	53.00	110.0	4	64.50	11.50
C27313.0	–	13.00	12.00	53.00	110.0	4	64.50	11.50
C27314.0	–	14.00	12.00	53.00	110.0	4	64.50	11.50
C27315.0	–	15.00	12.00	53.00	110.0	4	64.50	11.50
C2735/8²⁾	5/8	15.88	16.00	63.00	123.0	4	74.50	15.50
C27316.0	–	16.00	16.00	63.00	123.0	4	74.50	15.50



SOLID MILLS – PAGE OVERVIEW

Pos.	Description	Pos.	Description
1	Designation of solid mills	6	Milling operations
2	Product description	7	Material group recommendations incl. speed and feed guidance
3	Illustrative picture	8	Product code
4	Schematic drawing of tool	9	Product dimensions
5	Product features		



SOLID HM & HSS MILLS – ICONS OVERVIEW

General icons

	Primary use
	Possible use

Material code (BMC)

HM	Hard Material (Solid Carbide)	HSS-E	High Speed Cobalt Steel Tool Material
HSS-E PM	High Speed Cobalt Powder Metal Tool Material	HSS	High Speed Steel Tool Material

Mill Profile

N	General Purpose Cutter Type for Low to High Resistance Materials	NR	Coarse Pitch Rounded Profile Chipbreaker		Coarse Pitch
W	Non-ferrous Cutter Type for Soft Malleable Materials	HRA	Fine Pitch Asymmetrical Rounded Profile Chipbreaker		Fine Pitch
FS	Semi-finishing Profile Chipbreaker	NRA	Coarse Pitch Asymmetrical Rounded Profile Chipbreaker		
NF	Coarse Pitch Flat Profile Chipbreaker	W NRA	Non-ferrous Cutter Type with Coarse Pitch Asymmetrical Rounded Profile Chipbreaker		

Number of flutes (NOF)

	Number of Flutes = 1 (single tooth)		Number of Flutes = 4 – 5 (teeth)		Number of Flutes = 16 – 24 (teeth)
	Number of Flutes = 2 (teeth)		Number of Flutes = 5 (teeth)		Number of Teeth = 28 – 44 (teeth)
	Number of Flutes = 3 (teeth)		Number of Flutes = 4 – 6 (teeth)		Number of Teeth = 32 – 100 (teeth)
	Number of Flutes = 3 (differential pitch)		Number of Flutes = 4 – 8 (teeth)		Number of Teeth = 48 – 200 (teeth)
	Number of Flutes = 3 – 4 (teeth)		Number of Flutes = 6 – 8 (teeth)		Number of Teeth = 100 – 140 (teeth)
	Number of Flutes = 3 – 5 (teeth)		Number of Flutes = 6 – 12 (teeth)		Number of Teeth = 110 – 180 (teeth)
	Number of Flutes = 3 – 6 (teeth)		Number of Flutes = 8 (teeth)		Number of Teeth = 130 – 220 (teeth)
	Number of Flutes = 4 (teeth)		Number of Flutes = 8 – 12 (teeth)		Number of Teeth = 160 – 350 (teeth)
	Number of Flutes = 4 (differential pitch)		Number of Flutes = 10 – 12 (teeth)		



SOLID HM & HSS MILLS – ICONS OVERVIEW





Cut length





	Cut Length, Extra Short
	Cut Length, Short

	Cut Length, Medium
	Cut Length, Long

	Cut Length, Extra long
---	------------------------







Flute Helix (FHA)







	Unequal (Variable) Helix
	0° Helix Angle (Straight Flute)
	10° Helix Angle (Flute)
	12° Helix Angle (Flute)
	15° Helix Angle (Flute)





	25° Helix Angle (Flute)
	28° Helix Angle (Flute)
	30° Helix Angle (Flute)
	34° Helix Angle (Flute)
	35° Helix Angle (Flute)

	40° Helix Angle (Flute)
	45° Helix Angle (Flute)
	50° Helix Angle (Flute)

Radial rake angle (GAMF)

	-26° Radial Rake Angle (cutting)
	-10° Radial Rake Angle (cutting)
	-6° Radial Rake Angle (cutting)
	0° Radial Rake Angle (Neutral)
	3° Radial Rake Angle (cutting)
	4° Radial Rake Angle (cutting)

	5° Radial Rake Angle (cutting)
	7° Radial Rake Angle (cutting)
	8° Radial Rake Angle (cutting)
	9° Radial Rake Angle (cutting)
	10° Radial Rake Angle (cutting)
	12° Radial Rake Angle (cutting)

	13° Radial Rake Angle (cutting)
	15° Radial Rake Angle (cutting)
	18° Radial Rake Angle (cutting)
	20° Radial Rake Angle (cutting)
	25° Radial Rake Angle (cutting)

Shank

	DIN 1835A Cylindrical Shank
	DIN 1835 – B (Weldon) or D (Threaded) Shank











	DIN 1835D Threaded Shank
	DIN 1835B Weldon Shank

	DIN 6535 HA Cylindrical Shank
	DIN 6535 HB Weldon Shank













SOLID HM & HSS MILLS – ICONS OVERVIEW





Coating

 Alcrona	Aluminium Chromium Nitride Coating	 AlCrN	Aluminium Chromium Nitride Coating	 TiSiN	Titanium Silicon Nitride Coating
 Bright	Bright (uncoated)	 AlTiN	Aluminium Titanium Nitride Coating	 X-CEED	Special AlTiN Coating (with highest oxidation resistance)
 ST	Steam Tempered (Steam Oxide) Surface Treatment	 Hi	Polished Bright Surface Finish	 Diamond	Diamond Like Coating
 TiCN	Titanium Carbonitride Coating	 TiAlN	Titanium Aluminium Nitride Coating		















Cutting Diameter Tolerance Class (TCDC)

 DC d11	d11 – Industry Standard Tool Tolerance Zone (based on diameter range)	 DC h11	h11 – Industry Standard Tool Tolerance Zone (based on diameter range)	 DC k10	k10 – Industry Standard Tool Tolerance Zone (based on diameter range)
 DC e8	e8 – Industry Standard Tool Tolerance Zone (based on diameter range)	 DC h12	h12 – Industry Standard Tool Tolerance Zone (based on diameter range)	 DC k12	k12 – Industry Standard Tool Tolerance Zone (based on diameter range)
 DC h9	h9 – Industry Standard Tool Tolerance Zone (based on diameter range)	 DC js14	js14 – Industry Standard Tool Tolerance Zone (based on diameter range)		
 DC h10	h10 – Industry Standard Tool Tolerance Zone (based on diameter range)	 DC js16	js16 – Industry Standard Tool Tolerance Zone (based on diameter range)		

Cutting Direction

 Radial	 Radial, Diagonal, Axial
 Radial, Diagonal	 Radial

Basic Standard Group (BSG)

 BS 122/4	BS 122/4 – Screwed Shank End Mill Standards	 DIN 1880	DIN 1880 – Shell Mill Standards	 DIN 851	DIN 851 – T-Slot Cutter Standards
 DIN 1833C	DIN 1833 C – Dovetail Cutter Standards	 DIN 327D	DIN 327 D – Slot Drill Standards	 DIN 885A	DIN 885 A – Side & Face Mill Standards
 DIN 1833D	DIN 1833 D – Inverted Dovetail Cutter Standards	 DIN 844K	DIN 844 K – End Mill Standards	 DIN 6527K	DIN 6527 K – Carbide End Mill Standards
 DIN 1837	DIN 1837 – Fine Slitting Saw Standards	 DIN 844L	DIN 844 L – HSS End Mills Standards	 DIN 6527L	DIN 6527 L – Carbide End Mill Standards
 DIN 1838	DIN 1838 – Coarse Slitting Saw Standards	 DIN 850	DIN 850 – Keyseat Cutter Standards	 DORMER	DORMER Standards



SOLID HM & HSS MILLS – ICONS OVERVIEW

Cooling (CSP)



Through Tool Coolant

Operations Milling



Deep Shoulder Milling



Deep Slot Milling



Shallow Slot Milling



Shallow Shoulder Milling



P9 Slotting (Keyway)



Ramping



Plunge Milling



Trochoidal Milling



Progressive Plunging



Drilling



Helical Interpolation



Turn Milling



Contoured Surfaces (Copy Milling)



Face Milling



Chamfer Milling



Rear Face Milling



T-Slot Milling



Dovetail Milling



Inverse Dovetail Milling



Woodruff Slot Milling



Milling – Tube Sawing



Milling – Cut-off Sawing



DORMER PRAMET



YOUR PERSONAL LIBRARY

Always revisiting the same sections of our publications? Our library app allows you to save key pages that you can revert back to again and again, whenever you need to. Simply Reliable. **Simply Reliable.**





SOLID HM MILLS





SOLID HM MILLS – TOOL MATERIALS AND SURFACE COATINGS NAVIGATOR







HM materials

Carbide Materials (or Hard Materials)		<p>A sintered powder metallurgy substrate, consisting of a metallic carbide composite with binder metal. The most central raw material is tungsten carbide (WC). Tungsten carbide contributes to the hardness of the material. Tantalum carbide (TaC), titanium carbide (TiC) and niobium carbide (NbC) complements WC and adjusts the properties to what is desired. These three materials are called cubic carbides. Cobalt (Co) acts as a binder and keeps the material together.</p> <p>Carbide materials are often characterised by high compression strength, high hardness and therefore high wear resistance, but also by limited flexural strength and toughness. Carbide is used in taps, reamers, milling cutters, drills and thread milling cutters.</p>
--	---	--

Surface Treatments

Bright (uncoated)		<p>Bright finish (uncoated surface) improves chip flow in soft or non-ferrous materials and maintains sharp cutting edges in abrasive materials.</p>
Polished Bright Surface Finish		<p>Bright polished surface finish greatly improves chip flow in soft or gummy non-ferrous materials. Polishing facilitates chip evacuation and prevents material from sticking to cutting edges and in flutes.</p>

Surface Coatings

Aluminium Chromium Nitride Coating (AlCrN)		<p>The Alcrona (AlCrN) family of coatings are aluminum chromium nitride coatings mostly used for milling cutters. The two unique properties of these coatings are high hot hardness and high oxidation resistance. When used on tools for machining applications involving heavy mechanical and thermal stresses, these properties translate into superior wear resistance. Multiple levels or specific versions of these coatings are available and specific for various tools and applications.</p>
Titanium Silicon Nitride Coating (TiSiN)		<p>TiSiN is designed for extreme cutting conditions and high speed machining of hard materials. This multi-layered coating has a nano-composite outer layer with Si_3N_4 nano-crystallites in a crystalline TiN matrix and is engineered to protect the cutting edge from heat transfer, oxidation and abrasion. TiSiN coatings can perform well at minimum to zero lubrication conditions.</p>
Titanium Aluminium Nitride Coating (TiAlN)		<p>Titanium Aluminium Nitride is a multi layer ceramic coating applied by PVD coating technology, which exhibits high toughness and oxidation stability. These properties make it ideal for higher speeds and feeds, while at the same time improving tool life. TiAlN is used in drilling, tapping, and milling applications and can be suitable for use when machining without coolant.</p>
Titanium Aluminium Nitride Coatings (X-CEED)		<p>X-CEED type TiAlN coating, also known as Futura-Nano coating is a nanolayered coating designed for higher hot hardness and higher stress applications.</p>
Aluminium Titanium Nitride (AlTiN)		<p>Aluminium Titanium Nitride (AlTiN) is a nanolayered broad based coating technology which is an upgrade to the conventional TiAlN coatings and can offer superior toughness, high hot hardness and oxidation resistance.</p>
Diamond Like Coating (DLC)		<p>Diamond Like Coating, also known as Diamond Like Carbon (DLC) provides the highest lubricity when used on carbide tools and avoids built up edge when machining graphite or soft non-ferrous materials.</p>



SOLID HM MILLS – FAMILIES

With our assortment of Solid HM Mills we can offer solutions to machine material for practically any WMG.

Our Solid HM Mills families:

Line	Description
S7xx	With rake angle value from 7° to 10° offers a wide usage in medium strength steel and cast steels, medium strength stainless steels, cast irons and medium strength high temperature alloys.
S2xx	With rake angle value from 3° to 4° suits best for high alloyed steels >1200 to 1620 N/mm ² , medium strength stainless steels >850 N/mm ² and medium to high strength super alloys >900 N/mm ² .
S5xx	With an negative rake angle is suited for hardened materials above 54 HRC (S501 – S511 are not in).
S6xx	With high rake angle are ideal for non-ferrous materials with one exception: S612 is only for abrasive materials such as graphite.
S8xx S501 S511	Rake angle 10° suit for a multiapplication usage in mild up to medium strength steel and cast steels, mild to medium strength stainless steels, cast irons and non-ferrous materials such as aluminium and copper and its alloys.
S9xx	Rake angle 12° makes the cutter ideal for general purposes use for softer materials, such as free machining up to medium strength steel and cast steels, cast irons, non-ferrous materials and pure titanium.



Material code (BMC)	HM	HM	HM	HM	HM	HM	HM	HM	HM	HM	HM	HM	HM
Mill Profile	N	N	N	N	N	N	N	N	N	N	NRA	NRA	N
Number of flutes (NOF)	NOF 2	NOF 3	NOF 3	NOF 3	NOF 4	NOF 4	NOF 4	NOF 4#	NOF 4#	NOF 4#	NOF 4#	NOF 4#	NOF 4#
Cut length													
Flute Helix (FHA)	λ 40°	λ 40°	λ 40°	λ 40°	λ 40°	λ 40°	λ 40°	λ 40°	λ 40°	λ 40°	λ 40°	λ 40°	λ ≠
Radial rake angle (GAMF)	γ 10°	γ 10°	γ 10°	γ 10°	γ 10°	γ 10°	γ 10°	γ 7°	γ 10°	γ 10°	γ 10°	γ 10°	γ 10°
Shank	 DIN 6535HA	 DIN 6535HA	 DIN 6535HA	 DIN 6535HA	 DIN 6535HA	 DIN 6535HA	 DIN 6535HA	 DIN 6535HB	 DIN 6535HA	 DIN 6535HA	 DIN 6535HA	 DIN 6535HB	 DIN 6535HA
Coating	AICN	AICN	AICN	AICN	AICN	AICN	AICN	AICN	AICN	AICN	AICN	AICN	TISIN
Cutting diameter tolerance class (TDC)	DC h9	DC h9	DC h9	DC h9	DC h9	DC h9	DC h9	DC h9	DC h9	DC h9	DC h9	DC h9	DC h9
Direction													
Basic standard group (BSG)													
Cooling (CSP)													
Product Family Code	S710	S713	S714	S715	S716	S717	S718	S722HB	S761	S763	S765	S765HB	S766
	1.00 - 20.00	1.50 - 20.00	3.00 - 20.00	3.00 - 20.00	2.00 - 20.00	3.00 - 20.00	3.00 - 20.00	3.00 - 20.00	3.00 - 20.00	3.00 - 20.00	6.00 - 20.00	6.00 - 20.00	4.00 - 20.00
	28	29	30	31	32	33	34	35	36	37	38	39	40
P	P1	■	■	■	■	■	■	■	■	■	■	■	■
	P2	■	■	■	■	■	■	■	■	■	■	■	■
	P3	■	■	■	■	■	■	■	■	■	■	■	■
	P4	■	■	■	■	■	■	■	■	■	■	■	■
M	M1	■	■	■	■	■	■	■	■	■	■	■	■
	M2	■	■	■	■	■	■	■	■	■	■	■	■
	M3	■	■	■	■	■	■	■	■	■	■	■	■
	M4												
K	K1	■	■	■	■	■	■	■	■	■	■	■	■
	K2	■	■	■	■	■	■	■	■	■	■	■	■
	K3	■	■	■	■	■	■	■	■	■	■	■	■
	K4	■	■	■	■	■	■	■	■	■	■	■	■
	K5	■	■	■	■	■	■	■	■	■	■	■	■
N	N1			☑	☑		☑	☑					
	N2			☑	☑		☑	☑					
	N3			☑	☑		☑	☑					
	N4												
	N5												
S	S1	■	■	■	■	■	■	■	■	■	■	■	■
	S2	■	■	■	■	■	■	■	■	■	■	■	■
	S3	■	■	■	■	■	■	■	■	■	■	■	■
	S4	■	■	■	■	■	■	■	■	■	■	■	■
H	H1												
	H2												
	H3												
	H4												

■ Primary use ☑ Possible use



	HM	HM	HM	HM	HM	HM	HM	HM	HM	HM	HM	HM	HM	HM	HM
	N	N	N	FS	N	FS	N	N	N	N	N	N	N	N	N
	NOF 4≠	NOF 4≠	NOF 5	NOF 5	NOF 5	NOF 5	NOF 3-4	NOF 2	NOF 2	NOF 4	NOF 4	NOF 4	NOF 4	NOF 6-8	NOF 6-8
	$\lambda \neq$	$\lambda \neq$	$\lambda \neq$	$\lambda \neq$	$\lambda \neq$	$\lambda \neq$	$\lambda 30^\circ$	$\lambda 40^\circ$	$\lambda 40^\circ$	$\lambda 40^\circ$	$\lambda 40^\circ$	$\lambda 40^\circ$	$\lambda 40^\circ$	$\lambda 50^\circ$	$\lambda 50^\circ$
	$\gamma 10^\circ$	$\gamma 10^\circ$	$\gamma 10^\circ$	$\gamma 10^\circ$	$\gamma 10^\circ$	$\gamma 10^\circ$	$\gamma 8^\circ$	$\gamma 10^\circ$	$\gamma 10^\circ$	$\gamma 3^\circ$	$\gamma 3^\circ$	$\gamma 3^\circ$	$\gamma 3^\circ$	$\gamma 3^\circ$	$\gamma 3^\circ$
	TiSiN	TiSiN	AlCrN	AlCrN	AlCrN	AlCrN	AlCrN	AlCrN	AlTiN	AlTiN	AlTiN	AlTiN	AlTiN	AlTiN	AlTiN
	DC h9	DC h9	DC h9	DC h9	DC h9	DC h9		DC h9	DC h9	DC h9	DC h9	DC h9	DC h9	DC h9	DC h9
	NEW	NEW		NEW	NEW	NEW	NEW								
	S767	S768	S770HB	S771HB	S772HB	S773HB	S791	S739	S740	S216	S217	S218	S219	S225	S226
	4.00 - 20.00	4.00 - 20.00	10.00 - 20.00	10.00 - 20.00	10.00 - 20.00	10.00 - 20.00	6.00 - 16.00	3.00 - 20.00	3.00 - 20.00	2.00 - 20.00	3.00 - 20.00	3.00 - 20.00	3.00 - 20.00	3.00 - 20.00	3.00 - 20.00
P1	■	■	■	■	■	■	■	■	■						
P2	■	■	■	■	■	■	■	■	■						
P3	■	■	■	■	■	■	■	■	■						
P4	■	■	■	■	■	■	■	■	■	▣	▣	▣	▣	▣	▣
M1	■	■	■	■	■	■	■	■	■						
M2	■	■	■	■	■	■	■	■	■						
M3	■	■	■	■	■	■	▣	■	■						
M4							▣		■						
K1	■	■	■	■	■	■	■	■	■						
K2	■	■	■	■	■	■	■	■	■						
K3	■	■	■	■	■	■	■	■	■						
K4	■	■	■	■	■	■	■	■	■						
K5	■	■	■	■	■	■	■	■	■						
N1							▣	■	■						
N2							▣	■	■						
N3							■	■	■						
N4							▣								
N5															
S1	■	■	■	■	■	■	▣	■	■						
S2	■	■	■	■	■	■	▣	■	■						
S3	■	■	■	■	■	■	▣	■	■						
S4	■	■	■	■	■	■	▣	■	■						
H1															
H2															
H3															
H4															

■ Primary use ▣ Possible use



Material code (BMC)	HM	HM	HM	HM	HM	HM	HM	HM	HM	HM	HM	HM	HM
Mill Profile	N	N	N	N	N	N	HRA	N	N	N	N	N	N
Number of flutes (NOF)	NOF 6-8	NOF 2	NOF 2	NOF 2	NOF 4≠	NOF 4≠	NOF 4≠	NOF 4	NOF 4	NOF 4	NOF 6-8	NOF 6-8	NOF 6-8
Cut length													
Flute Helix (FHA)	λ 50°	λ 30°	λ 30°	λ 30°	λ 40°	λ 40°	λ 40°	λ 45°	λ 40°	λ 40°	λ 50°	λ 50°	λ 50°
Radial rake angle (GAMF)	γ 3°	γ 3°	γ 3°	γ 3°	γ 4°	γ 4°	γ 4°	γ -10°	γ -6°	γ -6°	γ -26°	γ -26°	γ -26°
Shank	 DIN 6535HA	 DIN 6535HA	 DIN 6535HA	 DIN 6535HA	 DIN 6535HA	 DIN 6535HA	 DIN 6535HB	 DIN 6535HA	 DIN 6535HA	 DIN 6535HA	 DIN 6535HA	 DIN 6535HA	 DIN 6535HA
Coating	 ATIN	 TISIN	 TISIN	 TISIN	 AICN	 AICN	 AICN	 TISIN	 TISIN	 TISIN	 TISIN	 TISIN	 TISIN
Cutting diameter tolerance class (TDC)	DC h9	DC h9	DC h9	DC h9	DC h9	DC h9	DC h9	DC h9	DC h9	DC h9	DC h9	DC h9	DC h9
Direction													
Basic standard group (BSG)	 DORMER	 DORMER	 DORMER	 DORMER	 DORMER	 DORMER	 DORMER	 DORMER	 DORMER	 DORMER	 DORMER	 DORMER	 DORMER
Cooling (CSP)													
Product Family Code	S227 6.00 - 20.00 	S229 1.50 - 16.00 	S231 1.50 - 16.00 	S233 2.00 - 16.00 	S260 3.00 - 20.00 	S262 3.00 - 20.00 	S264 6.00 - 20.00 	S521 3.00 - 16.00 	S523 1.50 - 16.00 	S524 3.00 - 16.00 	S525 3.00 - 20.00 	S526 3.00 - 20.00 	S527 3.00 - 20.00
P	P1												
	P2												
	P3												
	P4	■	■	■	■								
M	M1												
	M2	■	■	■	■	■	■						
	M3	■	■	■	■	■	■						
	M4	■	■	■	■	■	■						
K	K1												
	K2												
	K3												
	K4												
	K5												
N	N1												
	N2												
	N3												
	N4												
	N5												
S	S1	■	■	■	■	■	■						
	S2	■	■	■	■	■	■						
	S3	■	■	■	■	■	■						
	S4	■	■	■	■	■	■						
H	H1					■	■	■	■	■	■	■	■
	H2					■	■	■	■	■	■	■	■
	H3					■	■	■	■	■	■	■	■
	H4							■	■	■	■	■	■

■ Primary use ■ Possible use



	HM	HM	HM	HM	HM	HM	HM	HM	HM	HM	HM	HM	HM	HM	HM		
	N	N	N	N	N	N	N	W	W	W	W	W	W	W	W	W	NRA
	NOF 2	NOF 2	NOF 2	NOF 4	NOF 4	NOF 4-6	NOF 4-6	NOF 1	NOF 2	NOF 2	NOF 3	NOF 2	NOF 2	NOF 3-6	NOF 3-6	NOF 3-6	NOF 3-6
	λ 30°	λ 30°	λ 30°	λ 30°	λ 30°	λ 25°	λ 40°	λ 25°	λ 30°	λ 30°	λ 40°	λ 30°	λ 30°	λ 40°	λ 40°	λ 40°	λ 40°
	γ -10°	γ -10°	γ -10°	γ -10°	γ -10°	γ 0°	γ -6°	γ 20°	γ 20°	γ 20°	γ 13°	γ 15°	γ 20°	γ 13°	γ 15°	γ 15°	γ 15°
	TISIN	TISIN	TISIN	TISIN	TISIN	TISIN	TISIN	Hi	Hi	Hi	Bright	Bright	Hi	Bright	Bright	Bright	Bright
	DC h9	DC h9	DC h9	DC h9	DC h9	DC h9	DC h9	DC h9	DC h9	DC h9	DC h9	DC h9	DC h9	DC h9	DC h9	DC h9	DC h9
	DORMER	DORMER	DORMER	DORMER	DORMER	DORMER	DORMER	DORMER	DORMER	DORMER	DORMER	DORMER	DORMER	DORMER	DORMER	DORMER	DORMER
	NEW						NEW				NEW			NEW	NEW	NEW	NEW
	S529	S531	S533	S534	S535	S536	S561	S637	S610	S611	S614	S629	S638	S650	S654	S654	S654
	1.50 - 16.00	1.50 - 16.00	2.00 - 16.00	3.00 - 16.00	3.00 - 16.00	6.00 - 12.00	1.00 - 20.00	2.00 - 12.00	2.00 - 20.00	3.00 - 20.00	3.00 - 16.00	1.00 - 20.00	6.20 - 20.30	1.00 - 20.00	6.00 - 20.00	6.00 - 20.00	6.00 - 20.00
	71	72	73	74	75	76	77	78	79	80	81	82	83	84	85	85	85
P1																	
P2																	
P3																	
P4																	
M1																	
M2																	
M3																	
M4																	
K1																	
K2																	
K3																	
K4																	
K5																	
N1								■	■	■	■	■	■	■	■	■	■
N2								■	■	■	■	■	■	■	■	■	■
N3								■	■	■	■	■	■	■	■	■	■
N4								■	■	■	■	■	■	■	■	■	■
N5																	
S1																	
S2																	
S3																	
S4																	
H1	■	■	■	■	■	■	■										
H2	■	■	■	■	■	■	■										
H3	■	■	■	■	■	■	■										
H4	■	■	■	■	■	■	■										



Material code (BMC)	HM	HM	HM	HM	HM	HM	HM	HM	HM	HM	HM	HM	HM
Mill Profile	W	N	N	N	N	N	N	N	N	N	N	N	N
Number of flutes (NOF)	NOF 4	NOF 4	NOF 2	NOF 2	NOF 2	NOF 2	NOF 2	NOF 3	NOF 3	NOF 3	NOF 3	NOF 3	NOF 4
Cut length													
Flute Helix (FHA)	λ 40°	λ 40°	λ 28°	λ 28°	λ 28°	λ 28°	λ 28°	λ 28°	λ 28°	λ 28°	λ 28°	λ 28°	λ 34°
Radial rake angle (GAMF)	γ 10°	γ 10°	γ 9°	γ 9°	γ 9°	γ 9°	γ 9°	γ 9°	γ 9°	γ 9°	γ 9°	γ 9°	γ 9°
Shank	 DIN 6535HA	 DIN 6535HA	 DIN 6535HA	 DIN 6535HB	 DIN 6535HA	 DIN 6535HB	 DIN 6535HA	 DIN 6535HA	 DIN 6535HB	 DIN 6535HA	 DIN 6535HB	 DIN 6535HA	 DIN 6535HA
Coating	Bright	Diamond	AICrN	AICrN	AICrN	AICrN	AICrN	AICrN	AICrN	AICrN	AICrN	AICrN	AICrN
Cutting diameter tolerance class (TDC)	DC h9	DC h9											DC h10
Direction													
Basic standard group (BSG)	DORNER	DORNER	DIN 6527K	DIN 6527K	DIN 6527L	DIN 6527L	DORNER	DIN 6527K	DIN 6527K	DIN 6527L	DIN 6527L	DORNER	DIN 6527K
Cooling (CSP)													
Product Family Code	NEW S662	S612	S802HA	S802HB	S812HA	S812HB	S822	S803HA	S803HB	S813HA	S813HB	S823	S804HA
	3.00 - 20.00	1.00 - 12.00	1.00 - 20.00	2.00 - 20.00	2.00 - 20.00	2.00 - 20.00	2.00 - 20.00	1.00 - 20.00	2.00 - 20.00	2.00 - 20.00	2.00 - 20.00	2.00 - 20.00	2.00 - 25.00
P	P1		■	■	■	■	■	■	■	■	■	■	■
	P2		■	■	■	■	■	■	■	■	■	■	■
	P3		■	■	■	■	■	■	■	■	■	■	■
	P4		■	■	■	■	■	■	■	■	■	■	■
M	M1		■	■	■	■	■	■	■	■	■	■	■
	M2		■	■	■	■	■	■	■	■	■	■	■
	M3		■	■	■	■	■	■	■	■	■	■	■
	M4		■	■	■	■	■	■	■	■	■	■	■
K	K1		■	■	■	■	■	■	■	■	■	■	■
	K2		■	■	■	■	■	■	■	■	■	■	■
	K3		■	■	■	■	■	■	■	■	■	■	■
	K4		■	■	■	■	■	■	■	■	■	■	■
	K5		■	■	■	■	■	■	■	■	■	■	■
N	N1	■	■	■	■	■	■	■	■	■	■	■	■
	N2	■	■	■	■	■	■	■	■	■	■	■	■
	N3	■	■	■	■	■	■	■	■	■	■	■	■
	N4	■	■	■	■	■	■	■	■	■	■	■	■
	N5		■										
S	S1		■	■	■	■	■	■	■	■	■	■	■
	S2		■	■	■	■	■	■	■	■	■	■	■
	S3		■	■	■	■	■	■	■	■	■	■	■
	S4		■	■	■	■	■	■	■	■	■	■	■
H	H1												
	H2												
	H3												
	H4												

■ Primary use ■ Possible use



S710



2-Flute Solid Carbide End Mill

Short cut length, 2-flute design with 40° helix provides high rigidity for milling standard slots. AlCrN coating improves performance and extends the tool life.

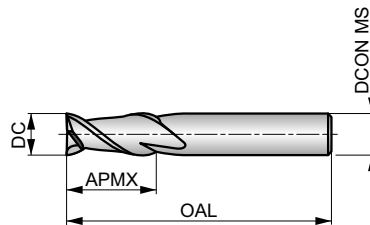

HM	N	NOF 2
	λ 40°	γ 10°
DIN 6535HA	AlCrN	DC h9
	DORMER	



Workpiece material group suitability, starting values for cutting speed (m/min) and Alpha Code. Tables with feed per tooth and correction factors can be found starting from page 112.

P1.1 ■ 199 K	P1.2 ■ 223 K	P1.3 ■ 230 K	P2.1 ■ 170 K	P2.2 ■ 150 K	P2.3 ■ 133 J	P3.1 ■ 138 K	P3.2 ■ 111 J	P3.3 ■ 94 J	P4.1 ■ 82 J	P4.2 ■ 70 J	M1.1 ■ 115 K	M1.2 ■ 97 K	M2.1 ■ 102 K
M2.2 ■ 84 J	M3.1 ■ 94 J	M3.2 ■ 81 J	K1.1 ■ 196 K	K1.2 ■ 145 K	K1.3 ■ 109 K	K2.1 ■ 202 K	K2.2 ■ 164 K	K2.3 ■ 131 J	K3.1 ■ 178 K	K3.2 ■ 136 K	K3.3 ■ 110 J	K4.1 ■ 165 J	K4.2 ■ 125 J
K4.3 ■ 91 J	K4.4 ■ 78 J	K4.5 ■ 65 J	K5.1 ■ 187 J	K5.2 ■ 141 J	K5.3 ■ 109 J	S1.2 ■ 69 J	S2.1 ■ 53 J	S3.1 ■ 40 J	S4.1 ■ 31 J				

DCON MS tolerance h6.

Product	DC [mm]	DCON MS [mm]	APMX [mm]	OAL [mm]	NOF
S7101.0	1.00	3.00	3.00	40.0	2
S7101.5	1.50	3.00	4.50	40.0	2
S7102.0	2.00	3.00	6.50	40.0	2
S7102.5	2.50	3.00	6.50	40.0	2
S7103.0	3.00	6.00	9.00	50.0	2
S7104.0	4.00	6.00	12.00	50.0	2
S7105.0	5.00	6.00	15.00	50.0	2
S7106.0	6.00	6.00	20.00	60.0	2
S7108.0	8.00	8.00	20.00	64.0	2
S71010.0	10.00	10.00	22.00	75.0	2
S71012.0	12.00	12.00	25.00	75.0	2
S71016.0	16.00	16.00	32.00	90.0	2
S71020.0	20.00	20.00	38.00	100.0	2



S713

3-Flute Solid Carbide End Mill

Short cut length, 3-flute design with 40° helix provides high rigidity for milling standard slots. AlCrN coating improves performance and extends the tool life.

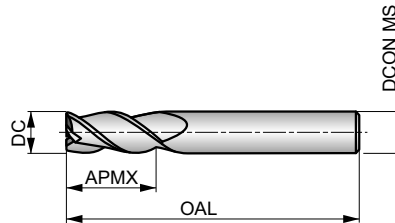
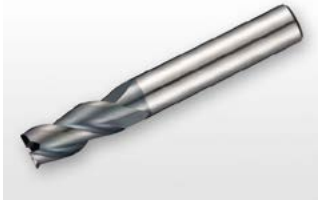

HM	N	NOF 3
	λ 40°	γ 10°
DIN 6535HA	AlCrN	DC h9
	DORMER	

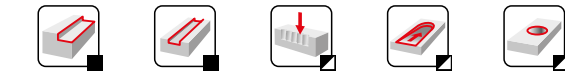

Workpiece material group suitability, starting values for cutting speed (m/min) and Alpha Code. Tables with feed per tooth and correction factors can be found starting from page 112.

P1.1 ■ 199 J	P1.2 ■ 223 J	P1.3 ■ 230 J	P2.1 ■ 170 J	P2.2 ■ 150 J	P2.3 ■ 133 I	P3.1 ■ 138 J	P3.2 ■ 111 I	P3.3 ■ 94 I	P4.1 ■ 82 I	P4.2 ■ 70 I	M1.1 ■ 115 J	M1.2 ■ 97 J	M2.1 ■ 102 J
M2.2 ■ 84 I	M3.1 ■ 94 I	M3.2 ■ 81 I	K1.1 ■ 196 J	K1.2 ■ 145 J	K1.3 ■ 109 J	K2.1 ■ 202 J	K2.2 ■ 164 J	K2.3 ■ 131 I	K3.1 ■ 178 J	K3.2 ■ 136 J	K3.3 ■ 110 I	K4.1 ■ 165 I	K4.2 ■ 125 I
K4.3 ■ 91 I	K4.4 ■ 78 I	K4.5 ■ 65 I	K5.1 ■ 187 I	K5.2 ■ 141 I	K5.3 ■ 109 I	S1.2 ■ 69 I	S2.1 ■ 53 I	S3.1 ■ 40 I	S4.1 ■ 31 I				

DCON MS tolerance h6.

Product	DC	DCON MS	APMX	OAL	NOF
	[mm]	[mm]	[mm]	[mm]	
S7131.5	1.50	4.00	4.50	40.0	3
S7132.0	2.00	4.00	6.50	40.0	3
S7133.0	3.00	3.00	9.00	40.0	3
S7134.0	4.00	4.00	12.00	50.0	3
S7135.0	5.00	5.00	15.00	50.0	3
S7136.0	6.00	6.00	16.00	50.0	3
S7138.0	8.00	8.00	20.00	64.0	3
S71310.0	10.00	10.00	22.00	70.0	3
S71312.0	12.00	12.00	25.00	75.0	3
S71314.0	14.00	14.00	32.00	90.0	3
S71316.0	16.00	16.00	32.00	90.0	3
S71318.0	18.00	18.00	38.00	100.0	3
S71320.0	20.00	20.00	38.00	100.0	3



S714



3-Flute Solid Carbide End Mill, Long Series

Long cut length, 3-flute design with 40° helix provides high rigidity for profile milling deep walls. AlCrN coating improves performance and extends the tool life.

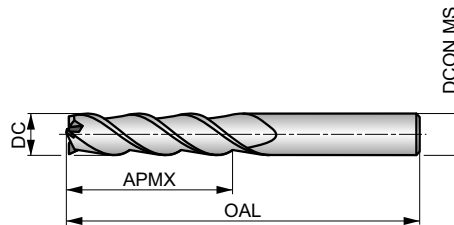

HM	N	NOF 3
	λ 40°	γ 10°
DIN 6535HA	AlCrN	DC h9
	DORMER	

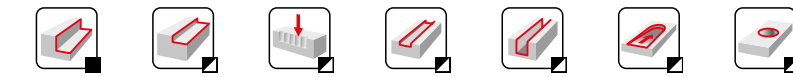

Workpiece material group suitability, starting values for cutting speed (m/min) and Alpha Code. Tables with feed per tooth and correction factors can be found starting from page 112.

P1.1 ■ 140 J	P1.2 ■ 157 J	P1.3 ■ 162 J	P2.1 ■ 120 J	P2.2 ■ 106 J	P2.3 ■ 94 I	P3.1 ■ 97 J	P3.2 ■ 78 I	P3.3 ■ 66 I	P4.1 ■ 58 I	P4.2 ■ 49 I	M1.1 ■ 81 J	M1.2 ■ 68 J	M2.1 ■ 71 J
M2.2 ■ 59 I	M3.1 ■ 66 I	M3.2 ■ 57 I	K1.1 ■ 138 J	K1.2 ■ 102 J	K1.3 ■ 77 J	K2.1 ■ 142 J	K2.2 ■ 115 J	K2.3 ■ 92 I	K3.1 ■ 125 J	K3.2 ■ 96 J	K3.3 ■ 78 I	K4.1 ■ 116 I	K4.2 ■ 88 I
K4.3 ■ 64 I	K4.4 ■ 55 I	K4.5 ■ 46 I	K5.1 ■ 132 I	K5.2 ■ 99 I	K5.3 ■ 77 I	N1.1 ▣ 1249 K	N1.2 ▣ 187 K	N1.3 ▣ 125 K	N2.1 ▣ 125 J	N2.2 ▣ 112 J	N2.3 ▣ 181 J	N3.1 ▣ 131 J	N3.2 ▣ 76 J
N3.3 ▣ 39 J	S1.2 ■ 49 I	S2.1 ■ 37 I	S3.1 ■ 28 I	S4.1 ■ 22 I									

DCON MS tolerance h6.

Product	DC [mm]	DCON MS [mm]	APMX [mm]	OAL [mm]	NOF
S7143.0	3.00	3.00	19.00	60.00	3
S7144.0	4.00	4.00	19.00	60.00	3
S7145.0	5.00	5.00	19.00	60.00	3
S7146.0	6.00	6.00	31.00	75.00	3
S7148.0	8.00	8.00	31.00	75.00	3
S71410.0	10.00	10.00	31.00	75.00	3
S71412.0	12.00	12.00	50.00	100.00	3
S71414.0	14.00	14.00	57.00	125.00	3
S71416.0	16.00	16.00	57.00	125.00	3
S71418.0	18.00	18.00	57.00	125.00	3
S71420.0	20.00	20.00	57.00	125.00	3



S715



3-Flute Solid Carbide End Mill, Extra Long Series

Extra long cut length, 3-flute design with 40° helix provides high rigidity for profile milling extra deep walls. AlCrN coating improves performance and extends the tool life.

HM	N	NOF 3
	λ 40°	γ 10°
DIN 6535HA	AlCrN	DC h9
	DORMER	

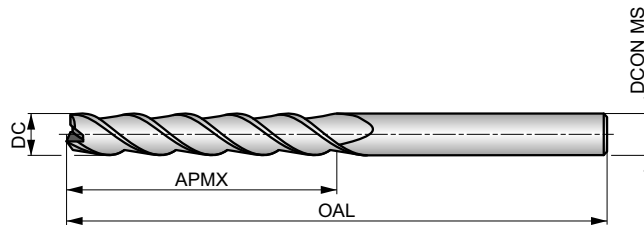

Workpiece material group suitability, starting values for cutting speed (m/min) and Alpha Code. Tables with feed per tooth and correction factors can be found starting from page 112.

P1.1 ■ 88 J	P1.2 ■ 98 J	P1.3 ■ 101 J	P2.1 ■ 75 J	P2.2 ■ 66 J	P2.3 ■ 59 I	P3.1 ■ 61 J	P3.2 ■ 49 I	P3.3 ■ 41 I	P4.1 ■ 36 I	P4.2 ■ 31 I	M1.1 ■ 50 J	M1.2 ■ 42 J	M2.1 ■ 44 J
M2.2 ■ 36 I	M3.1 ■ 41 I	M3.2 ■ 35 I	K1.1 ■ 86 J	K1.2 ■ 64 J	K1.3 ■ 48 J	K2.1 ■ 89 J	K2.2 ■ 72 J	K2.3 ■ 58 I	K3.1 ■ 79 J	K3.2 ■ 60 J	K3.3 ■ 49 I	K4.1 ■ 73 I	K4.2 ■ 55 I
K4.3 ■ 40 I	K4.4 ■ 35 I	K4.5 ■ 29 I	K5.1 ■ 83 I	K5.2 ■ 62 I	K5.3 ■ 48 I	N1.1 ▣ 178 K	N1.2 ▣ 134 K	N1.3 ▣ 90 K	N2.1 ▣ 190 J	N2.2 ▣ 180 J	N2.3 ▣ 58 J	N3.1 ▣ 94 J	N3.2 ▣ 55 J
N3.3 ▣ 28 J	S1.2 ■ 30 I	S2.1 ■ 23 I	S3.1 ■ 18 I	S4.1 ■ 14 I									

DCON MS tolerance h6.

Product	DC [mm]	DCON MS [mm]	APMX [mm]	OAL [mm]	NOF
S7153.0	3.00	3.00	25.00	100.0	3
S7154.0	4.00	4.00	31.00	100.0	3
S7155.0	5.00	5.00	31.00	100.0	3
S7156.0	6.00	6.00	38.00	100.0	3
S7158.0	8.00	8.00	41.00	100.0	3
S71510.0	10.00	10.00	57.00	125.0	3
S71512.0	12.00	12.00	75.00	150.0	3
S71514.0	14.00	14.00	75.00	150.0	3
S71516.0	16.00	16.00	75.00	150.0	3
S71518.0	18.00	18.00	75.00	150.0	3
S71520.0	20.00	20.00	75.00	150.0	3



S716



4-Flute Solid Carbide End Mill

Short cut length, 4-flute design with 40° helix provides high rigidity for standard profile milling. AlCrN coating improves performance and extends the tool life.

HM	N	NOF 4
	λ 40°	γ 10°
DIN 6535HA	AlCrN	DC h9
	DORMER	

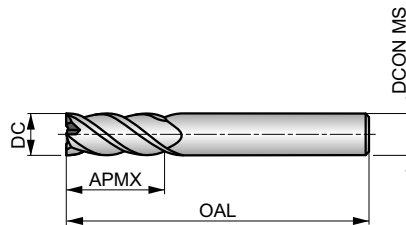

Workpiece material group suitability, starting values for cutting speed (m/min) and Alpha Code. Tables with feed per tooth and correction factors can be found starting from page 112.

P1.1 ■ 199 J	P1.2 ■ 223 J	P1.3 ■ 230 J	P2.1 ■ 170 J	P2.2 ■ 150 J	P2.3 ■ 133 I	P3.1 ■ 138 J	P3.2 ■ 111 I	P3.3 ■ 94 I	P4.1 ■ 82 I	P4.2 ■ 70 I	M1.1 ■ 115 J	M1.2 ■ 97 J	M2.1 ■ 102 J
M2.2 ■ 84 I	M3.1 ■ 94 I	M3.2 ■ 81 I	K1.1 ■ 196 J	K1.2 ■ 145 J	K1.3 ■ 109 J	K2.1 ■ 202 J	K2.2 ■ 164 J	K2.3 ■ 131 I	K3.1 ■ 178 J	K3.2 ■ 136 J	K3.3 ■ 110 I	K4.1 ■ 165 I	K4.2 ■ 125 I
K4.3 ■ 91 I	K4.4 ■ 78 I	K4.5 ■ 65 I	K5.1 ■ 187 I	K5.2 ■ 141 I	K5.3 ■ 109 I	S1.2 ■ 69 I	S2.1 ■ 53 I	S3.1 ■ 40 I	S4.1 ■ 31 I				

DCON MS tolerance h6.

Product	DC [mm]	DCON MS [mm]	APMX [mm]	OAL [mm]	NOF
S7162.0	2.00	4.00	6.50	40.0	4
S7163.0	3.00	3.00	9.00	40.0	4
S7164.0	4.00	4.00	12.00	50.0	4
S7165.0	5.00	5.00	15.00	50.0	4
S7166.0	6.00	6.00	16.00	50.0	4
S7168.0	8.00	8.00	20.00	64.0	4
S71610.0	10.00	10.00	22.00	70.0	4
S71612.0	12.00	12.00	25.00	75.0	4
S71614.0	14.00	14.00	32.00	90.0	4
S71616.0	16.00	16.00	32.00	90.0	4
S71618.0	18.00	18.00	38.00	100.0	4
S71620.0	20.00	20.00	38.00	100.0	4



S717



4-Flute Solid Carbide End Mill, Long Series

Long cut length, 4-flute design with 40° helix provides high rigidity for profile milling deep walls. AlCrN coating improves performance and extends the tool life.

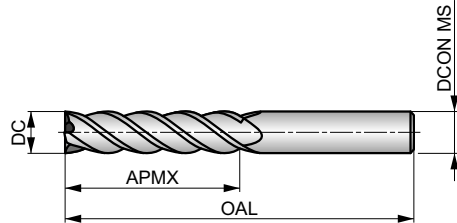

HM	N	NOF 4
	λ 40°	γ 10°
DIN 6535HA	AlCrN	DC h9
	DORMER	

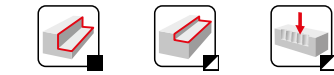

Workpiece material group suitability, starting values for cutting speed (m/min) and Alpha Code. Tables with feed per tooth and correction factors can be found starting from page 112.

P1.1 ■ 140 J	P1.2 ■ 157 J	P1.3 ■ 162 J	P2.1 ■ 120 J	P2.2 ■ 106 J	P2.3 ■ 94 I	P3.1 ■ 97 J	P3.2 ■ 78 I	P3.3 ■ 66 I	P4.1 ■ 58 I	P4.2 ■ 49 I	M1.1 ■ 81 J	M1.2 ■ 68 J	M2.1 ■ 71 J
M2.2 ■ 59 I	M3.1 ■ 66 I	M3.2 ■ 57 I	K1.1 ■ 138 J	K1.2 ■ 102 J	K1.3 ■ 77 J	K2.1 ■ 142 J	K2.2 ■ 115 J	K2.3 ■ 92 I	K3.1 ■ 125 J	K3.2 ■ 96 J	K3.3 ■ 78 I	K4.1 ■ 116 I	K4.2 ■ 88 I
K4.3 ■ 64 I	K4.4 ■ 55 I	K4.5 ■ 46 I	K5.1 ■ 132 I	K5.2 ■ 99 I	K5.3 ■ 77 I	N1.1 ▣ 249 K	N1.2 ▣ 187 K	N1.3 ▣ 125 K	N2.1 ▣ 125 J	N2.2 ▣ 112 J	N2.3 ▣ 81 J	N3.1 ▣ 131 J	N3.2 ▣ 76 J
N3.3 ▣ 39 J	S1.2 ■ 49 I	S2.1 ■ 37 I	S3.1 ■ 28 I	S4.1 ■ 22 I									

DCON MS tolerance h6.

Product	DC [mm]	DCON MS [mm]	APMX [mm]	OAL [mm]	NOF
S7173.0	3.00	3.00	19.00	60.0	4
S7174.0	4.00	4.00	19.00	60.0	4
S7175.0	5.00	5.00	19.00	60.0	4
S7176.0	6.00	6.00	31.00	75.0	4
S7178.0	8.00	8.00	31.00	75.0	4
S71710.0	10.00	10.00	31.00	75.0	4
S71712.0	12.00	12.00	50.00	100.0	4
S71714.0	14.00	14.00	57.00	125.0	4
S71716.0	16.00	16.00	57.00	125.0	4
S71718.0	18.00	18.00	57.00	125.0	4
S71720.0	20.00	20.00	57.00	125.0	4



S718



4-Flute Solid Carbide End Mill, Extra Long Series

Extra long cut length, 4-flute design with 40° helix provides high rigidity for profile milling extra deep walls. AlCrN coating improves performance and extends the tool life.

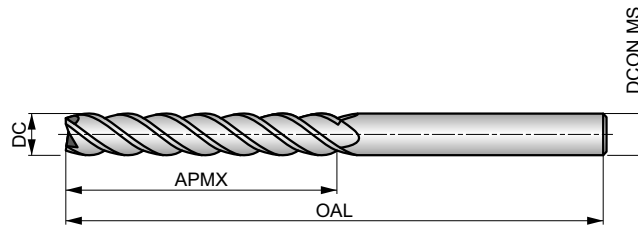

HM	N	NOF 4
	λ 40°	γ 10°
DIN 6535HA	AlCrN	DC h9
	DORMER	



Workpiece material group suitability, starting values for cutting speed (m/min) and Alpha Code. Tables with feed per tooth and correction factors can be found starting from page 112.

P1.1 ■ 88 J	P1.2 ■ 98 J	P1.3 ■ 101 J	P2.1 ■ 75 J	P2.2 ■ 66 J	P2.3 ■ 59 I	P3.1 ■ 61 J	P3.2 ■ 49 I	P3.3 ■ 41 I	P4.1 ■ 36 I	P4.2 ■ 31 I	M1.1 ■ 50 J	M1.2 ■ 42 J	M2.1 ■ 44 J
M2.2 ■ 36 I	M3.1 ■ 41 I	M3.2 ■ 35 I	K1.1 ■ 86 J	K1.2 ■ 64 J	K1.3 ■ 48 J	K2.1 ■ 89 J	K2.2 ■ 72 J	K2.3 ■ 58 I	K3.1 ■ 79 J	K3.2 ■ 60 J	K3.3 ■ 49 I	K4.1 ■ 73 I	K4.2 ■ 55 I
K4.3 ■ 40 I	K4.4 ■ 35 I	K4.5 ■ 29 I	K5.1 ■ 83 I	K5.2 ■ 62 I	K5.3 ■ 48 I	N1.1 ▣ 178 K	N1.2 ▣ 134 K	N1.3 ▣ 90 K	N2.1 ▣ 90 J	N2.2 ▣ 80 J	N2.3 ▣ 58 J	N3.1 ▣ 94 J	N3.2 ▣ 55 J
N3.3 ▣ 28 J	S1.2 ■ 30 I	S2.1 ■ 23 I	S3.1 ■ 18 I	S4.1 ■ 14 I									

DCON MS tolerance h6.

Product	DC [mm]	DCON MS [mm]	APMX [mm]	OAL [mm]	NOF
S7183.0	3.00	3.00	25.00	100.0	4
S7184.0	4.00	4.00	31.00	100.0	4
S7185.0	5.00	5.00	31.00	100.0	4
S7186.0	6.00	6.00	38.00	100.0	4
S7188.0	8.00	8.00	41.00	100.0	4
S71810.0	10.00	10.00	57.00	125.0	4
S71812.0	12.00	12.00	75.00	150.0	4
S71814.0	14.00	14.00	75.00	150.0	4
S71816.0	16.00	16.00	75.00	150.0	4
S71818.0	18.00	18.00	75.00	150.0	4
S71820.0	20.00	20.00	75.00	150.0	4



S722HB



4-Flute Solid Carbide End Mill

Medium cut length, 4-flute design with 40° helix, differential pitch and Weldon shank provides high rigidity for profile milling deep walls. Neck recess to avoid work contact with the wall and extend reach. AlCrN coating improves performance and extends the tool life.

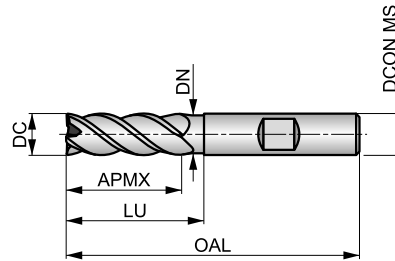

HM	N	NOF 4±
	λ 40°	γ 7°
DIN 6535HB	AlCrN	DC h9
	DORMER	



Workpiece material group suitability, starting values for cutting speed (m/min) and Alpha Code. Tables with feed per tooth and correction factors can be found starting from page 112.

P1.1 ■ 199 J	P1.2 ■ 223 J	P1.3 ■ 230 J	P2.1 ■ 170 J	P2.2 ■ 150 J	P2.3 ■ 133 I	P3.1 ■ 138 J	P3.2 ■ 111 I	P3.3 ■ 94 I	P4.1 ■ 82 I	P4.2 ■ 70 I	M1.1 ■ 115 J	M1.2 ■ 97 J	M2.1 ■ 102 J
M2.2 ■ 84 I	M3.1 ■ 94 I	M3.2 ■ 81 I	K1.1 ■ 196 J	K1.2 ■ 145 J	K1.3 ■ 109 J	K2.1 ■ 202 J	K2.2 ■ 164 J	K2.3 ■ 131 I	K3.1 ■ 178 J	K3.2 ■ 136 J	K3.3 ■ 110 I	K4.1 ■ 165 I	K4.2 ■ 125 I
K4.3 ■ 91 I	K4.4 ■ 78 I	K4.5 ■ 65 I	K5.1 ■ 187 I	K5.2 ■ 141 I	K5.3 ■ 109 I	S1.2 ■ 69 I	S2.1 ■ 53 I	S3.1 ■ 40 I	S4.1 ■ 31 I				

DCON MS tolerance h6; RE ±0.02 mm.

Product	DC [mm]	RE [mm]	DCON MS [mm]	APMX [mm]	OAL [mm]	NOF	LU [mm]	DN [mm]
S722HB3.0	3.00	0.10	6.00	9.00	50.0	4	15.00	2.80
S722HB4.0	4.00	0.10	6.00	11.00	57.0	4	20.00	3.70
S722HB5.0	5.00	0.10	6.00	13.00	57.0	4	20.00	4.60
S722HB6.0	6.00	0.10	6.00	20.00	60.0	4	25.00	5.50
S722HB8.0	8.00	0.20	8.00	20.00	64.0	4	26.00	7.40
S722HB10.0	10.00	0.20	10.00	27.00	70.0	4	32.00	9.20
S722HB12.0	12.00	0.20	12.00	26.00	83.0	4	37.00	11.00
S722HB14.0	14.00	0.20	14.00	26.00	83.0	4	37.00	13.00
S722HB16.0	16.00	0.20	16.00	32.00	92.0	4	42.00	15.00
S722HB18.0	18.00	0.20	18.00	32.00	92.0	4	42.00	17.00
S722HB20.0	20.00	0.20	20.00	38.00	104.0	4	50.00	19.00



S761



4-Flute Solid Carbide End Mill

Short cut length, 4-flute design with 40° helix and differential pitch to reduce vibrations and improve surface finish in profile milling. AlCrN coating improves performance and extends the tool life. Also suited for plunging, ramping and trochoidal milling.

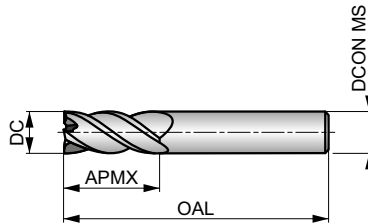

HM	N	NOF 4 \neq
	λ 40°	γ 10°
DIN 6535HA	AlCrN	DC h9
	DORMER	



Workpiece material group suitability, starting values for cutting speed (m/min) and Alpha Code. Tables with feed per tooth and correction factors can be found starting from page 112.

P1.1 ■ 211 J	P1.2 ■ 236 J	P1.3 ■ 243 J	P2.1 ■ 180 J	P2.2 ■ 158 J	P2.3 ■ 140 I	P3.1 ■ 146 J	P3.2 ■ 117 I	P3.3 ■ 99 I	P4.1 ■ 86 I	P4.2 ■ 74 I	M1.1 ■ 122 J	M1.2 ■ 103 J	M2.1 ■ 108 J
M2.2 ■ 89 I	M3.1 ■ 100 I	M3.2 ■ 86 I	K1.1 ■ 208 J	K1.2 ■ 154 J	K1.3 ■ 116 J	K2.1 ■ 214 J	K2.2 ■ 174 J	K2.3 ■ 139 I	K3.1 ■ 189 J	K3.2 ■ 145 J	K3.3 ■ 117 I	K4.1 ■ 176 I	K4.2 ■ 132 I
K4.3 ■ 97 I	K4.4 ■ 83 I	K4.5 ■ 69 I	K5.1 ■ 199 I	K5.2 ■ 149 I	K5.3 ■ 116 I	S1.2 ■ 72 I	S2.1 ■ 56 I	S3.1 ■ 42 I	S4.1 ■ 33 I				

DCON MS tolerance h6.

Product	DC [mm]	DCON MS [mm]	APMX [mm]	OAL [mm]	NOF
S7613.0	3.00	6.00	9.00	57.0	4
S7614.0	4.00	6.00	12.00	57.0	4
S7615.0	5.00	6.00	13.00	57.0	4
S7616.0	6.00	6.00	13.00	57.0	4
S7618.0	8.00	8.00	20.00	64.0	4
S76110.0	10.00	10.00	22.00	72.0	4
S76112.0	12.00	12.00	26.00	83.0	4
S76114.0	14.00	14.00	32.00	83.0	4
S76116.0	16.00	16.00	32.00	92.0	4
S76120.0	20.00	20.00	38.00	104.0	4



S763



4-Flute Solid Carbide Corner Radius End Mill

Short cut length, 4-flute design with different corner radius available, 40° helix with differential pitch to reduce vibrations and improve surface finish, when milling contours where a corner radius is required. AlCrN coating improves performance. Also suited for plunging, ramping, z-level roughing and helical interpolation.

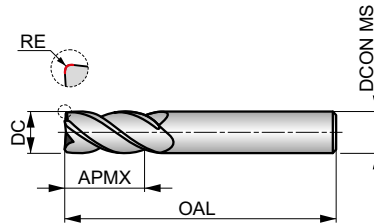

HM	N	NOF 4±
	λ 40°	γ 10°
DIN 6535HA	AlCrN	DC h9
	DORMER	

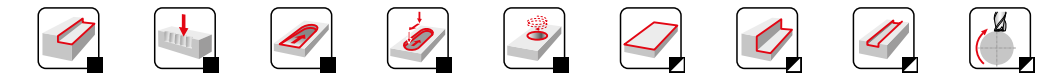

Workpiece material group suitability, starting values for cutting speed (m/min) and Alpha Code. Tables with feed per tooth and correction factors can be found starting from page 112.

P1.1 ■ 211 J	P1.2 ■ 236 J	P1.3 ■ 243 J	P2.1 ■ 180 J	P2.2 ■ 158 J	P2.3 ■ 140 I	P3.1 ■ 146 J	P3.2 ■ 117 I	P3.3 ■ 99 I	P4.1 ■ 86 I	P4.2 ■ 74 I	M1.1 ■ 122 J	M1.2 ■ 103 J	M2.1 ■ 108 J
M2.2 ■ 89 I	M3.1 ■ 100 I	M3.2 ■ 86 I	K1.1 ■ 208 J	K1.2 ■ 154 J	K1.3 ■ 116 J	K2.1 ■ 214 J	K2.2 ■ 174 J	K2.3 ■ 139 I	K3.1 ■ 189 J	K3.2 ■ 145 J	K3.3 ■ 117 I	K4.1 ■ 176 I	K4.2 ■ 132 I
K4.3 ■ 97 I	K4.4 ■ 83 I	K4.5 ■ 69 I	K5.1 ■ 199 I	K5.2 ■ 149 I	K5.3 ■ 116 I	S1.2 ■ 72 I	S2.1 ■ 56 I	S3.1 ■ 42 I	S4.1 ■ 33 I				

DCON MS tolerance h6; RE ±0.01 mm.

Product	DC [mm]	RE [mm]	DCON MS [mm]	APMX [mm]	OAL [mm]	NOF
S7633.0XR0.3	3.00	0.30	3.00	9.00	40.0	4
S7634.0XR0.3	4.00	0.30	4.00	12.00	50.0	4
S7634.0XR0.5	4.00	0.50	4.00	12.00	50.0	4
S7635.0XR0.3	5.00	0.30	5.00	15.00	50.0	4
S7635.0XR0.5	5.00	0.50	5.00	15.00	50.0	4
S7636.0XR0.5	6.00	0.50	6.00	16.00	50.0	4
S7636.0XR1.0	6.00	1.00	6.00	16.00	50.0	4
S7638.0XR0.5	8.00	0.50	8.00	20.00	64.0	4
S7638.0XR1.0	8.00	1.00	8.00	20.00	64.0	4
S76310.0XR0.5	10.00	0.50	10.00	22.00	70.0	4
S76310.0XR1.0	10.00	1.00	10.00	22.00	70.0	4
S76310.0XR2.0	10.00	2.00	10.00	22.00	70.0	4
S76312.0XR1.0	12.00	1.00	12.00	25.00	75.0	4
S76312.0XR2.0	12.00	2.00	12.00	25.00	75.0	4
S76312.0XR3.0	12.00	3.00	12.00	25.00	75.0	4
S76314.0XR1.5	14.00	1.50	14.00	32.00	90.0	4
S76316.0XR1.0	16.00	1.00	16.00	32.00	90.0	4
S76316.0XR2.0	16.00	2.00	16.00	32.00	90.0	4
S76316.0XR3.0	16.00	3.00	16.00	32.00	90.0	4
S76318.0XR2.0	18.00	2.00	18.00	38.00	100.0	4
S76320.0XR3.0	20.00	3.00	20.00	38.00	100.0	4



S765

DORMER



4-Flute Solid Carbide Roughing End Mill, DIN 6535 HA Shank

Short cut length, 4-flute design with 40° helix and differential pitch to reduce vibrations. The NRA profile is designed to break chips for efficient roughing applications. AlCrN coating improves performance and extends the tool life. Also suited for slotting and trochoidal roughing operation.

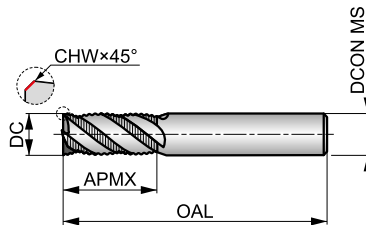

HM	NRA	NOF 4#
	λ 40°	γ 10°
DIN 6535HA	AlCrN	DC h9
	DORMER	



Workpiece material group suitability, starting values for cutting speed (m/min) and Alpha Code. Tables with feed per tooth and correction factors can be found starting from page 112.

P1.1 ■ 211 J	P1.2 ■ 236 J	P1.3 ■ 243 J	P2.1 ■ 180 J	P2.2 ■ 158 J	P2.3 ■ 140 J	P3.1 ■ 146 J	P3.2 ■ 117 J	P3.3 ■ 99 J	P4.1 ■ 86 J	P4.2 ■ 74 J	M1.1 ■ 122 J	M1.2 ■ 103 J	M2.1 ■ 108 J
M2.2 ■ 89 J	M3.1 ■ 100 J	M3.2 ■ 86 J	K1.1 ■ 208 J	K1.2 ■ 154 J	K1.3 ■ 116 J	K2.1 ■ 214 J	K2.2 ■ 174 J	K2.3 ■ 139 J	K3.1 ■ 189 J	K3.2 ■ 145 J	K3.3 ■ 117 J	K4.1 ■ 176 J	K4.2 ■ 132 J
K4.3 ■ 97 J	K4.4 ■ 83 J	K4.5 ■ 69 J	K5.1 ■ 199 J	K5.2 ■ 149 J	K5.3 ■ 116 J	S1.2 ■ 72 J	S2.1 ■ 56 J	S3.1 ■ 42 J	S4.1 ■ 33 J				

DCON MS tolerance h6; CHW ± 0.02X45° mm.

Product	DC [mm]	CHW [mm]	DCON MS [mm]	APMX [mm]	OAL [mm]	NOF
S7656.0	6.00	0.10	6.00	16.00	50.0	4
S7658.0	8.00	0.20	8.00	20.00	64.0	4
S76510.0	10.00	0.20	10.00	22.00	70.0	4
S76512.0	12.00	0.20	12.00	26.00	75.0	4
S76514.0	14.00	0.30	14.00	32.00	90.0	4
S76516.0	16.00	0.30	16.00	32.00	90.0	4
S76518.0	18.00	0.30	18.00	38.00	100.0	4
S76520.0	20.00	0.40	20.00	38.00	100.0	4



S765HB



4-Flute Solid Carbide Roughing End Mill, DIN 6535 HB Shank

Short cut length, 4-flute design with 40° helix and differential pitch to reduce vibrations. The NRA profile is designed to break chips for efficient roughing applications. The Weldon shank prevents the end mill from slipping in the toolholder. AlCrN coating. Also suited for slotting and trochoidal roughing operation.

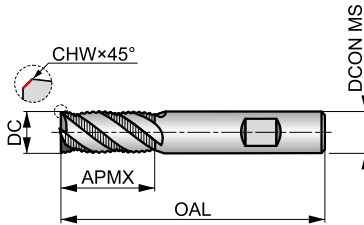

HM	NRA	NOF 4±
	λ 40°	γ 10°
DIN 6535HB	AlCrN	DC h9
	DORMER	



Workpiece material group suitability, starting values for cutting speed (m/min) and Alpha Code. Tables with feed per tooth and correction factors can be found starting from page 112.

P1.1 ■ 211 J	P1.2 ■ 236 J	P1.3 ■ 243 J	P2.1 ■ 180 J	P2.2 ■ 158 J	P2.3 ■ 140 J	P3.1 ■ 146 J	P3.2 ■ 117 J	P3.3 ■ 99 J	P4.1 ■ 86 J	P4.2 ■ 74 J	M1.1 ■ 122 J	M1.2 ■ 103 J	M2.1 ■ 108 J
M2.2 ■ 89 J	M3.1 ■ 100 J	M3.2 ■ 86 J	K1.1 ■ 208 J	K1.2 ■ 154 J	K1.3 ■ 116 J	K2.1 ■ 214 J	K2.2 ■ 174 J	K2.3 ■ 139 J	K3.1 ■ 189 J	K3.2 ■ 145 J	K3.3 ■ 117 J	K4.1 ■ 176 J	K4.2 ■ 132 J
K4.3 ■ 97 J	K4.4 ■ 83 J	K4.5 ■ 69 J	K5.1 ■ 199 J	K5.2 ■ 149 J	K5.3 ■ 116 J	S1.2 ■ 72 J	S2.1 ■ 56 J	S3.1 ■ 42 J	S4.1 ■ 33 J				

DCON MS tolerance h6; CHW ± 0.02X45° mm.

Product	DC [mm]	CHW [mm]	DCON MS [mm]	APMX [mm]	OAL [mm]	NOF
S765HB6.0	6.00	0.10	6.00	16.00	50.0	4
S765HB8.0	8.00	0.20	8.00	20.00	64.0	4
S765HB10.0	10.00	0.20	10.00	22.00	70.0	4
S765HB12.0	12.00	0.20	12.00	26.00	75.0	4
S765HB14.0	14.00	0.30	14.00	32.00	90.0	4
S765HB16.0	16.00	0.30	16.00	32.00	90.0	4
S765HB18.0	18.00	0.30	18.00	38.00	100.0	4
S765HB20.0	20.00	0.40	20.00	38.00	100.0	4



S766



4-Flute Solid Carbide End Mill

Short cut length, 4-flute design with unequal helix and differential pitch to reduce vibrations and improve surface finish in profile milling. TiSiN coating increases tool life and improves performance. Also suited for plunging, ramping and trochoidal milling.

HM	N	NOF 4#
	λ ≠	γ 10°
DIN 6535HA	TiSiN	DC h9
	DORMER	

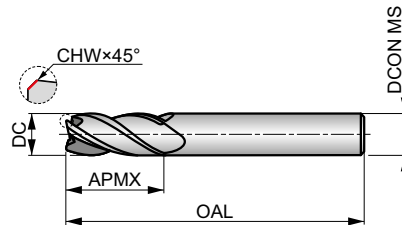

Workpiece material group suitability, starting values for cutting speed (m/min) and Alpha Code. Tables with feed per tooth and correction factors can be found starting from page 112.

P1.1 ■ 211 J	P1.2 ■ 236 J	P1.3 ■ 243 J	P2.1 ■ 180 J	P2.2 ■ 158 J	P2.3 ■ 140 I	P3.1 ■ 146 J	P3.2 ■ 117 I	P3.3 ■ 99 I	P4.1 ■ 86 I	P4.2 ■ 74 I	M1.1 ■ 122 J	M1.2 ■ 103 J	M2.1 ■ 108 J
M2.2 ■ 89 I	M3.1 ■ 100 I	M3.2 ■ 86 I	K1.1 ■ 208 J	K1.2 ■ 154 J	K1.3 ■ 116 J	K2.1 ■ 214 J	K2.2 ■ 174 J	K2.3 ■ 139 I	K3.1 ■ 189 J	K3.2 ■ 145 J	K3.3 ■ 117 I	K4.1 ■ 176 I	K4.2 ■ 132 I
K4.3 ■ 97 I	K4.4 ■ 83 I	K4.5 ■ 69 I	K5.1 ■ 199 I	K5.2 ■ 149 I	K5.3 ■ 116 I	S1.2 ■ 72 I	S2.1 ■ 56 I	S3.1 ■ 42 I	S4.1 ■ 33 I				

DCON MS tolerance h6; CHW ± 0.02X45° mm.

Product	DC [mm]	CHW [mm]	DCON MS [mm]	APMX [mm]	OAL [mm]	NOF
S7664.0	4.00	0.10	6.00	11.00	57.0	4
S7665.0	5.00	0.10	6.00	13.00	57.0	4
S7666.0	6.00	0.10	6.00	13.00	57.0	4
S7668.0	8.00	0.20	8.00	20.00	64.0	4
S76610.0	10.00	0.20	10.00	22.00	72.0	4
S76612.0	12.00	0.20	12.00	26.00	83.0	4
S76614.0	14.00	0.30	14.00	26.00	83.0	4
S76616.0	16.00	0.30	16.00	32.00	92.0	4
S76620.0	20.00	0.40	20.00	38.00	104.0	4



S767



4-Flute Solid Carbide Corner Radius End Mill

Short cut length, 4-flute design with different corner radius available, unequal helix and differential pitch to reduce vibrations and improve surface finish when milling contours where a corner radius is required. TiSiN coating improves performance. Also suited for plunging, ramping and trochoidal milling.

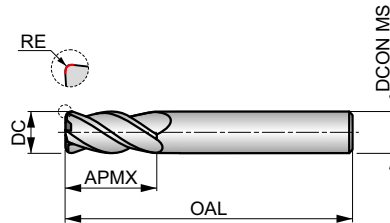

HM	N	NOF 4±
	$\lambda \neq$	$\gamma 10^\circ$
DIN 6535HA	TiSiN	DC h9
	DORMER	



Workpiece material group suitability, starting values for cutting speed (m/min) and Alpha Code. Tables with feed per tooth and correction factors can be found starting from page 112.

P1.1 ■ 211 J	P1.2 ■ 236 J	P1.3 ■ 243 J	P2.1 ■ 180 J	P2.2 ■ 158 J	P2.3 ■ 140 I	P3.1 ■ 146 J	P3.2 ■ 117 I	P3.3 ■ 99 I	P4.1 ■ 86 I	P4.2 ■ 74 I	M1.1 ■ 122 J	M1.2 ■ 103 J	M2.1 ■ 108 J
M2.2 ■ 89 I	M3.1 ■ 100 I	M3.2 ■ 86 I	K1.1 ■ 208 J	K1.2 ■ 154 J	K1.3 ■ 116 J	K2.1 ■ 214 J	K2.2 ■ 174 J	K2.3 ■ 139 I	K3.1 ■ 189 J	K3.2 ■ 145 J	K3.3 ■ 117 I	K4.1 ■ 176 I	K4.2 ■ 132 I
K4.3 ■ 97 I	K4.4 ■ 83 I	K4.5 ■ 69 I	K5.1 ■ 199 I	K5.2 ■ 149 I	K5.3 ■ 116 I	S1.2 ■ 72 I	S2.1 ■ 56 I	S3.1 ■ 42 I	S4.1 ■ 33 I				

DCON MS tolerance h6; RE ±0.01 mm.

Product	DC [mm]	RE [mm]	DCON MS [mm]	APMX [mm]	OAL [mm]	NOF
S7674.0XR0.3	4.00	0.30	6.00	11.00	57.0	4
S7674.0XR0.5	4.00	0.50	6.00	11.00	57.0	4
S7675.0XR0.3	5.00	0.30	6.00	13.00	57.0	4
S7675.0XR0.5	5.00	0.50	6.00	13.00	57.0	4
S7676.0XR0.3	6.00	0.30	6.00	13.00	57.0	4
S7676.0XR0.5	6.00	0.50	6.00	13.00	57.0	4
S7676.0XR1.0	6.00	1.00	6.00	13.00	57.0	4
S7678.0XR0.3	8.00	0.30	8.00	20.00	64.0	4
S7678.0XR0.5	8.00	0.50	8.00	20.00	64.0	4
S7678.0XR1.0	8.00	1.00	8.00	20.00	64.0	4
S76710.0XR0.3	10.00	0.30	10.00	22.00	72.0	4
S76710.0XR0.5	10.00	0.50	10.00	22.00	72.0	4
S76710.0XR1.0	10.00	1.00	10.00	22.00	72.0	4
S76712.0XR0.3	12.00	0.30	12.00	26.00	83.0	4
S76712.0XR0.5	12.00	0.50	12.00	26.00	83.0	4
S76712.0XR1.0	12.00	1.00	12.00	26.00	83.0	4
S76712.0XR2.0	12.00	2.00	12.00	26.00	83.0	4
S76716.0XR0.3	16.00	0.30	16.00	32.00	92.0	4
S76716.0XR0.5	16.00	0.50	16.00	32.00	92.0	4
S76716.0XR1.0	16.00	1.00	16.00	32.00	92.0	4
S76716.0XR2.0	16.00	2.00	16.00	32.00	92.0	4
S76720.0XR0.3	20.00	0.30	20.00	38.00	104.0	4
S76720.0XR0.5	20.00	0.50	20.00	38.00	104.0	4
S76720.0XR1.0	20.00	1.00	20.00	38.00	104.0	4
S76720.0XR2.0	20.00	2.00	20.00	38.00	104.0	4



S768

DORMER



4-Flute Solid Carbide End Mill, Long Series

Long cut length, 4-flute design with unequal helix and differential pitch to reduce vibrations and improve surface finish when milling deep walls in profile milling. Neck recess to avoid work contact with the wall and extend reach. TiSiN coating increases tool life and improves performance.

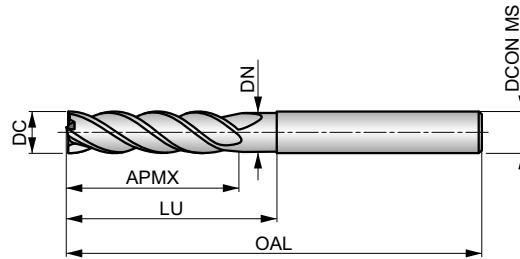

HM	N	NOF 4#
	λ ≠	γ 10°
DIN 6535HA	TiSiN	DC h9
	DORMER	



Workpiece material group suitability, starting values for cutting speed (m/min) and Alpha Code. Tables with feed per tooth and correction factors can be found starting from page 112.

P1.1 ■ 148 l	P1.2 ■ 165 l	P1.3 ■ 170 l	P2.1 ■ 126 l	P2.2 ■ 111 l	P2.3 ■ 98 G	P3.1 ■ 102 l	P3.2 ■ 82 G	P3.3 ■ 69 G	P4.1 ■ 60 G	P4.2 ■ 52 G	M1.1 ■ 85 l	M1.2 ■ 72 l	M2.1 ■ 76 l
M2.2 ■ 62 l	M3.1 ■ 70 l	M3.2 ■ 60 l	K1.1 ■ 146 l	K1.2 ■ 108 l	K1.3 ■ 81 l	K2.1 ■ 150 l	K2.2 ■ 122 l	K2.3 ■ 97 G	K3.1 ■ 132 l	K3.2 ■ 102 l	K3.3 ■ 82 G	K4.1 ■ 123 G	K4.2 ■ 92 G
K4.3 ■ 68 G	K4.4 ■ 58 l	K4.5 ■ 48 l	K5.1 ■ 139 G	K5.2 ■ 104 G	K5.3 ■ 81 G	S1.2 ■ 50 l	S2.1 ■ 39 G	S3.1 ■ 29 G	S4.1 ■ 23 G				

DCON MS tolerance h6; RE ±0.01 mm.

Product	DC [mm]	RE [mm]	DCON MS [mm]	APMX [mm]	OAL [mm]	NOF	LU [mm]	DN [mm]
S7684.0	4.00	0.10	6.00	19.00	75.0	4	32.00	3.70
S7685.0	5.00	0.10	6.00	19.00	75.0	4	32.00	4.60
S7686.0	6.00	0.10	6.00	25.00	75.0	4	32.00	5.50
S7688.0	8.00	0.20	8.00	30.00	75.0	4	38.00	7.40
S76810.0	10.00	0.20	10.00	40.00	100.0	4	50.00	9.20
S76812.0	12.00	0.30	12.00	45.00	100.0	4	55.00	11.00
S76816.0	16.00	0.30	16.00	65.00	125.0	4	75.00	15.00
S76820.0	20.00	0.30	20.00	65.00	125.0	4	75.00	19.00



S770HB



5-Flute Solid Carbide End Mill

Short cut length, 5-flute design with unequal helix to reduce vibrations especially when using the cutter in dynamic milling strategies. AlCrN coating improves performance and extends the tool life. Suited for trochoidal and shoulder milling, ramping and helicoidal interpolation milling.

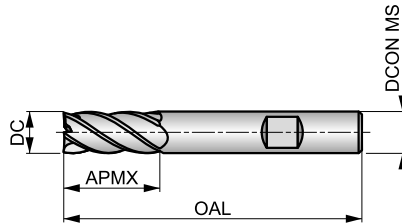

HM	N	NOF 5
	$\lambda \neq$	γ 10°
DIN 6535HB	AlCrN	DC h9
	DORMER	



Workpiece material group suitability, starting values for cutting speed (m/min) and Alpha Code. Tables with feed per tooth and correction factors can be found starting from page 112.

P1.1 ■ 211 l	P1.2 ■ 236 l	P1.3 ■ 243 l	P2.1 ■ 180 l	P2.2 ■ 158 l	P2.3 ■ 140 l	P3.1 ■ 146 l	P3.2 ■ 117 l	P3.3 ■ 99 l	P4.1 ■ 86 l	P4.2 ■ 74 l	M1.1 ■ 122 l	M1.2 ■ 103 l	M2.1 ■ 108 l
M2.2 ■ 89 l	M3.1 ■ 100 l	M3.2 ■ 86 l	K1.1 ■ 208 l	K1.2 ■ 154 l	K1.3 ■ 116 l	K2.1 ■ 214 l	K2.2 ■ 174 l	K2.3 ■ 139 l	K3.1 ■ 189 l	K3.2 ■ 145 l	K3.3 ■ 117 l	K4.1 ■ 176 l	K4.2 ■ 132 l
K4.3 ■ 97 l	K4.4 ■ 83 G	K4.5 ■ 69 G	K5.1 ■ 199 l	K5.2 ■ 149 l	K5.3 ■ 116 l	S1.2 ■ 72 l	S2.1 ■ 56 G	S3.1 ■ 42 G	S4.1 ■ 33 G				

DCON MS tolerance h6; RE ±0.01 mm.

Product	DC [mm]	RE [mm]	DCON MS [mm]	APMX [mm]	OAL [mm]	NOF
S770HB10.0	10.00	0.20	10.00	22.00	72.0	5
S770HB12.0	12.00	0.30	12.00	26.00	83.0	5
S770HB16.0	16.00	0.30	16.00	32.00	92.0	5
S770HB20.0	20.00	0.30	20.00	38.00	104.0	5



S771HB



5-Flute Solid Carbide End Mill, Chip Dividers and Through Coolant

Short cut length, 5-flute design with neck recess and unequal helix helps to reduce vibrations especially when using the cutter in dynamic milling strategies. AlCrN coating improves performance and extends the tool life. Chip divider and through coolant improve chip evacuation in pocketing operation.

HM	FS	NOF 5
	$\lambda \neq$	γ 10°
DIN 6535HB	AlCrN	DC h9
	DORMER	

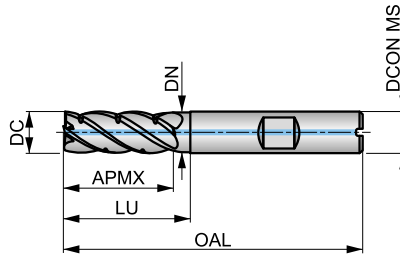

Workpiece material group suitability, starting values for cutting speed (m/min) and Alpha Code. Tables with feed per tooth and correction factors can be found starting from page 112.

P1.1 ■ 222 J	P1.2 ■ 248 J	P1.3 ■ 255 J	P2.1 ■ 189 J	P2.2 ■ 166 J	P2.3 ■ 147 I	P3.1 ■ 153 J	P3.2 ■ 123 I	P3.3 ■ 104 I	P4.1 ■ 90 I	P4.2 ■ 78 I	M1.1 ■ 128 I	M1.2 ■ 108 I	M2.1 ■ 113 I
M2.2 ■ 93 I	M3.1 ■ 105 I	M3.2 ■ 90 I	K1.1 ■ 218 J	K1.2 ■ 162 J	K1.3 ■ 122 J	K2.1 ■ 225 J	K2.2 ■ 183 J	K2.3 ■ 146 I	K3.1 ■ 198 J	K3.2 ■ 152 I	K3.3 ■ 123 I	K4.1 ■ 185 I	K4.2 ■ 139 I
K4.3 ■ 102 I	K4.4 ■ 87 I	K4.5 ■ 72 I	K5.1 ■ 209 I	K5.2 ■ 156 I	K5.3 ■ 122 I	S1.2 ■ 76 I	S2.1 ■ 59 I	S3.1 ■ 44 G	S4.1 ■ 35 G				

DCON MS tolerance h6; RE ±0.01 mm.

Product	DC [mm]	RE [mm]	DCON MS [mm]	APMX [mm]	OAL [mm]	NOF	LU [mm]	DN [mm]
S771HB10.0	10.00	0.20	10.00	25.00	72.0	5	30.00	9.70
S771HB12.0	12.00	0.20	12.00	30.00	83.0	5	38.00	11.70
S771HB16.0	16.00	0.30	16.00	39.00	92.0	5	44.00	15.70
S771HB20.0	20.00	0.30	20.00	48.00	104.0	5	54.00	19.70



S772HB



5-Flute Solid Carbide End Mill, Long Series

Long cut length, 5-flute design with unequal helix to reduce vibrations especially when using the cutter in dynamic milling strategies. AlCrN coating improves performance and extends the tool life. Suited for trochoidal and shoulder milling, ramping and helicoidal interpolation milling.

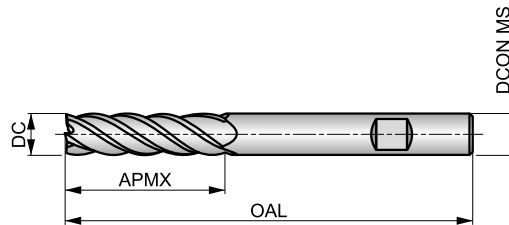
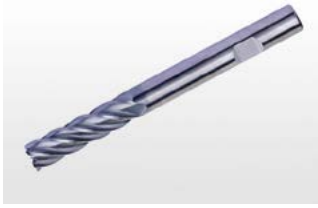

HM	N	NOF 5
	$\lambda \neq$	γ 10°
DIN 6535HB	AlCrN	DC h9
	DORMER	



Workpiece material group suitability, starting values for cutting speed (m/min) and Alpha Code. Tables with feed per tooth and correction factors can be found starting from page 112.

P1.1 ■ 148 G	P1.2 ■ 165 G	P1.3 ■ 170 G	P2.1 ■ 126 G	P2.2 ■ 111 G	P2.3 ■ 98 F	P3.1 ■ 102 G	P3.2 ■ 82 F	P3.3 ■ 69 F	P4.1 ■ 60 F	P4.2 ■ 52 F	M1.1 ■ 85 G	M1.2 ■ 72 G	M2.1 ■ 76 G
M2.2 ■ 62 G	M3.1 ■ 70 G	M3.2 ■ 60 G	K1.1 ■ 146 G	K1.2 ■ 108 G	K1.3 ■ 81 G	K2.1 ■ 150 G	K2.2 ■ 122 G	K2.3 ■ 97 F	K3.1 ■ 132 G	K3.2 ■ 102 G	K3.3 ■ 82 F	K4.1 ■ 123 F	K4.2 ■ 92 F
K4.3 ■ 68 F	K4.4 ■ 58 G	K4.5 ■ 48 G	K5.1 ■ 139 F	K5.2 ■ 104 F	K5.3 ■ 81 F	S1.2 ■ 50 F	S2.1 ■ 39 F	S3.1 ■ 29 F	S4.1 ■ 23 F				

DCON MS tolerance h6; RE ±0.01 mm.

Product	DC [mm]	RE [mm]	DCON MS [mm]	APMX [mm]	OAL [mm]	NOF
S772HB10.0	10.00	0.20	10.00	38.00	100.0	5
S772HB12.0	12.00	0.30	12.00	45.00	100.0	5
S772HB16.0	16.00	0.30	16.00	55.00	125.0	5
S772HB20.0	20.00	0.30	20.00	65.00	125.0	5



S773HB



5-Flute Solid Carbide End Mill, Chip Dividers, Through Coolant, Long Series

Long cut length, 5-flute design with neck recess and unequal helix helps to reduce vibrations especially when using the cutter in dynamic milling strategies. AlCrN coating improves performance and extends the tool life. Chip divider and through coolant improve chip evacuation in pocketing operations.

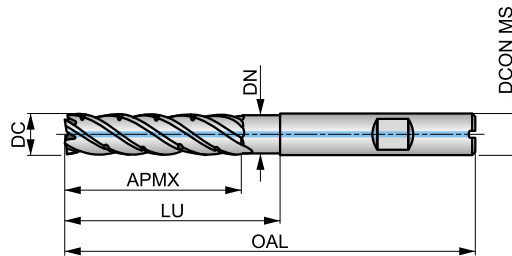

HM	FS	NOF 5
	$\lambda \neq$	$\gamma 10^\circ$
DIN 6535HB	AlCrN	DC h9
	DORMER	



Workpiece material group suitability, starting values for cutting speed (m/min) and Alpha Code. Tables with feed per tooth and correction factors can be found starting from page 112.

P1.1 ■ 155 G	P1.2 ■ 173 G	P1.3 ■ 179 G	P2.1 ■ 132 G	P2.2 ■ 117 G	P2.3 ■ 103 F	P3.1 ■ 107 G	P3.2 ■ 86 F	P3.3 ■ 72 F	P4.1 ■ 63 F	P4.2 ■ 55 F	M1.1 ■ 89 F	M1.2 ■ 76 F	M2.1 ■ 80 F
M2.2 ■ 65 F	M3.1 ■ 74 F	M3.2 ■ 63 F	K1.1 ■ 153 G	K1.2 ■ 113 G	K1.3 ■ 85 G	K2.1 ■ 158 G	K2.2 ■ 128 G	K2.3 ■ 102 F	K3.1 ■ 139 G	K3.2 ■ 107 G	K3.3 ■ 86 F	K4.1 ■ 129 F	K4.2 ■ 97 F
K4.3 ■ 71 F	K4.4 ■ 61 F	K4.5 ■ 50 F	K5.1 ■ 146 F	K5.2 ■ 109 F	K5.3 ■ 85 F	S1.2 ■ 53 F	S2.1 ■ 41 F	S3.1 ■ 30 F	S4.1 ■ 24 F				

DCON MS tolerance h6; RE ±0.01 mm.

Product	DC [mm]	RE [mm]	DCON MS [mm]	APMX [mm]	OAL [mm]	NOF	LU [mm]	DN [mm]
S773HB10.0	10.00	0.20	10.00	42.00	100.0	5	52.00	9.70
S773HB12.0	12.00	0.20	12.00	42.00	100.0	5	54.00	11.70
S773HB16.0	16.00	0.30	16.00	60.00	125.0	5	68.00	15.70
S773HB20.0	20.00	0.30	20.00	67.00	125.0	5	75.00	19.70



S791



3-4 Flute Solid Carbide Barrel-Shape End Mill

Medium cut length, 3 or 4 flute design with large tangential radius and ball nosed to increase contact with workpiece to reduce cycle time and improve surface finish of steep walls. AlCrN coating improves performance and extends the tool life. For semi-finishing and finishing operation.

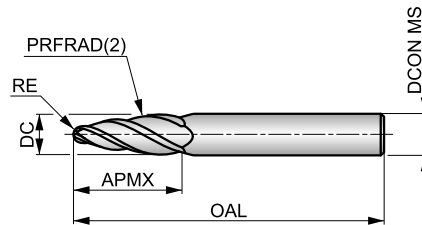

HM	N	NOF 3-4
	λ 30°	γ 8°
DIN 6535HA	AlCrN	
DORMER		



Workpiece material group suitability, starting values for cutting speed (m/min) and Alpha Code. Tables with feed per tooth and correction factors can be found starting from page 112.

P1.1 ■ 161 F	P1.2 ■ 181 F	P1.3 ■ 186 F	P2.1 ■ 138 F	P2.2 ■ 121 F	P2.3 ■ 108 E	P3.1 ■ 112 F	P3.2 ■ 90 E	P3.3 ■ 76 E	P4.1 ■ 66 E	P4.2 ■ 57 E	P4.3 ■ 46 E	M1.1 ■ 94 F	M1.2 ■ 79 F
M2.1 ■ 83 F	M2.2 ■ 69 E	M3.1 ■ 77 E	M3.2 ■ 66 E	M3.3 ■ 59 E	M4.1 ■ 58 E	K1.1 ■ 161 F	K1.2 ■ 119 F	K1.3 ■ 89 F	K2.1 ■ 165 F	K2.2 ■ 134 F	K2.3 ■ 107 E	K3.1 ■ 146 F	K3.2 ■ 112 F
K3.3 ■ 90 E	K4.1 ■ 136 E	K4.2 ■ 102 E	K4.3 ■ 75 E	K4.4 ■ 64 E	K4.5 ■ 54 E	K5.1 ■ 154 E	K5.2 ■ 115 E	K5.3 ■ 89 E	N1.1 ■ 355 I	N1.2 ■ 267 I	N1.3 ■ 179 I	N2.1 ■ 179 F	N2.2 ■ 160 F
N2.3 ■ 115 F	N3.1 ■ 187 F	N3.2 ■ 109 F	N3.3 ■ 56 F	N4.1 ■ 187 F	N4.2 ■ 72 F	S1.1 ■ 58 E	S1.2 ■ 56 E	S2.1 ■ 43 E	S3.1 ■ 33 E	S4.1 ■ 26 E			

DCON MS tolerance h6; RE ±0.01 mm; PRFRAD(2) ±0.01 mm.

Product	DC [mm]	RE [mm]	PRFRAD(2) [mm]	DCON MS [mm]	APMX [mm]	OAL [mm]	NOF
S7916.0	6.00	1.00	95.0	6.00	22.00	67.0	3
S7918.0	8.00	1.00	90.0	8.00	25.00	75.0	3
S79110.0	10.00	2.00	85.0	10.00	26.00	75.0	4
S79112.0	12.00	2.00	80.0	12.00	28.00	83.0	4
S79116.0	16.00	3.00	75.0	16.00	31.00	90.0	4



S739



2-Flute Solid Carbide Chamfering End Mill, 60°

Short cut length, 2-flute design provides high rigidity and reduces vibrations. The 60° point is designed for chamfer milling on CNC machines. AlTiN coating increases tool life and improves performance.

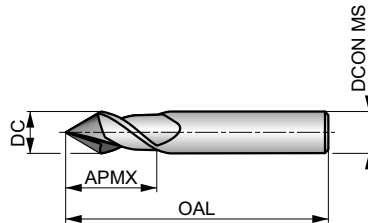

HM	N	NOF 2
	λ 40°	γ 10°
DIN 6535HA	AlTiN	DC h9
	DORMER	

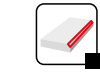

Workpiece material group suitability, starting values for cutting speed (m/min) and Alpha Code. Tables with feed per tooth and correction factors can be found starting from page 112.

P1.1 ■ 199 K	P1.2 ■ 223 K	P1.3 ■ 230 K	P2.1 ■ 170 K	P2.2 ■ 150 K	P2.3 ■ 133 J	P3.1 ■ 138 K	P3.2 ■ 111 J	P3.3 ■ 94 J	P4.1 ■ 82 J	P4.2 ■ 70 J	M1.1 ■ 115 K	M1.2 ■ 97 K	M2.1 ■ 102 K
M2.2 ■ 84 J	M3.1 ■ 94 J	M3.2 ■ 81 J	K1.1 ■ 196 K	K1.2 ■ 145 K	K1.3 ■ 109 K	K2.1 ■ 202 K	K2.2 ■ 164 K	K2.3 ■ 131 J	K3.1 ■ 178 K	K3.2 ■ 136 K	K3.3 ■ 110 J	K4.1 ■ 165 J	K4.2 ■ 125 J
K4.3 ■ 91 J	K4.4 ■ 78 J	K4.5 ■ 65 J	K5.1 ■ 187 J	K5.2 ■ 141 J	K5.3 ■ 109 J	N1.1 ■ 355 N	N1.2 ■ 267 N	N1.3 ■ 179 N	N2.1 ■ 179 K	N2.2 ■ 160 K	N2.3 ■ 115 K	N3.1 ■ 187 K	N3.2 ■ 109 K
N3.3 ■ 56 K	S1.2 ■ 69 J	S2.1 ■ 53 J	S3.1 ■ 40 J	S4.1 ■ 31 J									

DCON MS tolerance h6.

Product	KAPR [°]	DC [mm]	DCON MS [mm]	APMX [mm]	OAL [mm]	NOF
S7393.0	60	3.00	3.00	9.00	40.0	2
S7394.0	60	4.00	4.00	12.00	50.0	2
S7395.0	60	5.00	5.00	15.00	50.0	2
S7396.0	60	6.00	6.00	16.00	50.0	2
S7398.0	60	8.00	8.00	20.00	64.0	2
S73910.0	60	10.00	10.00	22.00	70.0	2
S73912.0	60	12.00	12.00	25.00	75.0	2
S73916.0	60	16.00	16.00	32.00	90.0	2
S73920.0	60	20.00	20.00	38.00	100.0	2



S740



2-Flute Solid Carbide Chamfering End Mill, 90°

Short cut length, 2-flute design provides high rigidity and reduces vibrations. The 90° point is designed for chamfer milling on CNC machines. AlTiN coating increases tool life and improves performance.

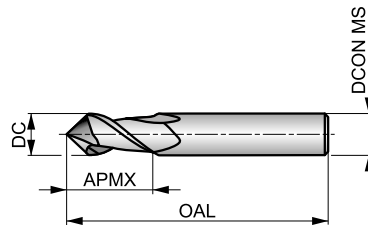

HM	N	NOF 2
	λ 40°	γ 10°
DIN 6535HA	AlTiN	DC h9



Workpiece material group suitability, starting values for cutting speed (m/min) and Alpha Code. Tables with feed per tooth and correction factors can be found starting from page 112.

P1.1 ■ 199 K	P1.2 ■ 223 K	P1.3 ■ 230 K	P2.1 ■ 170 K	P2.2 ■ 150 K	P2.3 ■ 133 J	P3.1 ■ 138 K	P3.2 ■ 111 J	P3.3 ■ 94 J	P4.1 ■ 82 J	P4.2 ■ 70 J	M1.1 ■ 115 K	M1.2 ■ 97 K	M2.1 ■ 102 K
M2.2 ■ 84 J	M3.1 ■ 94 J	M3.2 ■ 81 J	K1.1 ■ 196 K	K1.2 ■ 145 K	K1.3 ■ 109 K	K2.1 ■ 202 K	K2.2 ■ 164 K	K2.3 ■ 131 J	K3.1 ■ 178 K	K3.2 ■ 136 K	K3.3 ■ 110 J	K4.1 ■ 165 J	K4.2 ■ 125 J
K4.3 ■ 91 J	K4.4 ■ 78 J	K4.5 ■ 65 J	K5.1 ■ 187 J	K5.2 ■ 141 J	K5.3 ■ 109 J	N1.1 ■ 355 N	N1.2 ■ 267 N	N1.3 ■ 179 N	N2.1 ■ 179 K	N2.2 ■ 160 K	N2.3 ■ 115 K	N3.1 ■ 187 K	N3.2 ■ 109 K
N3.3 ■ 156 K	S1.2 ■ 69 J	S2.1 ■ 53 J	S3.1 ■ 40 J	S4.1 ■ 31 J									

DCON MS tolerance h6.

Product	KAPR	DC	DCON MS	APMX	OAL	NOF
	[°]	[mm]	[mm]	[mm]	[mm]	
S7403.0	90	3.00	3.00	9.00	40.0	2
S7404.0	90	4.00	4.00	12.00	50.0	2
S7405.0	90	5.00	5.00	15.00	50.0	2
S7406.0	90	6.00	6.00	16.00	50.0	2
S7408.0	90	8.00	8.00	20.00	64.0	2
S74010.0	90	10.00	10.00	22.00	70.0	2
S74012.0	90	12.00	12.00	25.00	75.0	2
S74016.0	90	16.00	16.00	32.00	90.0	2
S74020.0	90	20.00	20.00	38.00	100.0	2



S216



4-Flute Solid Carbide End Mill

Short cut length, 4-flute design provides high rigidity for standard profile milling. AlTiN coating increases tool life and improves performance when milling difficult to machine materials. The 40° helix is designed for high performance machining.

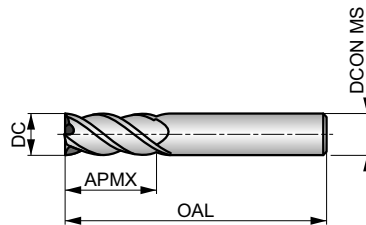

HM	N	NOF 4
	λ 40°	γ 3°
DIN 6535HA	AlTiN	DC h9
	DORMER	



Workpiece material group suitability, starting values for cutting speed (m/min) and Alpha Code. Tables with feed per tooth and correction factors can be found starting from page 112.

P4.3	M2.3	M3.3	M4.1	M4.2	S1.3	S2.2	S3.2	S4.2
■ 80 J	■ 80 J	■ 82 I	■ 80 I	■ 68 I	■ 58 I	■ 47 I	■ 33 I	■ 27 I

DCON MS tolerance h6.

Product	DC [mm]	DCON MS [mm]	APMX [mm]	OAL [mm]	NOF
S2162.0	2.00	4.00	6.50	40.0	4
S2163.0XD3	3.00	3.00	9.00	40.0	4
S2163.0XD6	3.00	6.00	9.00	50.0	4
S2164.0XD4	4.00	4.00	12.00	50.0	4
S2164.0XD6	4.00	6.00	12.00	50.0	4
S2165.0	5.00	5.00	15.00	50.0	4
S2166.0	6.00	6.00	16.00	50.0	4
S2168.0	8.00	8.00	20.00	64.0	4
S21610.0	10.00	10.00	22.00	70.0	4
S21612.0	12.00	12.00	25.00	75.0	4
S21614.0	14.00	14.00	32.00	90.0	4
S21616.0	16.00	16.00	32.00	90.0	4
S21618.0	18.00	18.00	38.00	100.0	4
S21620.0	20.00	20.00	38.00	100.0	4



S217



4-Flute Solid Carbide End Mill, Long Series

Long cut length, 4-flute design provides high rigidity for profile milling deep walls. AlTiN coating increases tool life and improves performance when milling difficult to machine materials. The 40° helix is designed for high performance machining.

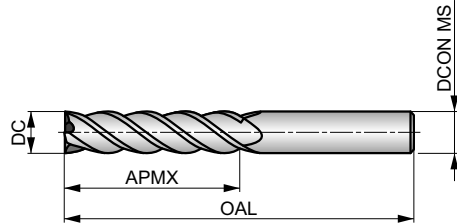

HM	N	NOF 4
	λ 40°	γ 3°
DIN 6535HA	AlTiN	DC h9
	DORMER	

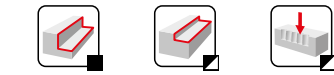

Workpiece material group suitability, starting values for cutting speed (m/min) and Alpha Code. Tables with feed per tooth and correction factors can be found starting from page 112.

P4.3 ■ 64 J	M2.3 ■ 64 J	M3.3 ■ 65 I	M4.1 ■ 64 I	M4.2 ■ 54 I	S1.3 ■ 46 I	S2.2 ■ 38 I	S3.2 ■ 26 I	S4.2 ■ 22 I
-----------------------	-----------------------	-----------------------	-----------------------	-----------------------	-----------------------	-----------------------	-----------------------	-----------------------

DCON MS tolerance h6.

Product	DC	DCON MS	APMX	OAL	NOF
	[mm]	[mm]	[mm]	[mm]	
S2173.0XD3	3.00	3.00	19.00	60.0	4
S2173.0XD6	3.00	6.00	19.00	75.0	4
S2174.0XD4	4.00	4.00	19.00	60.0	4
S2174.0XD6	4.00	6.00	19.00	75.0	4
S2175.0	5.00	5.00	19.00	60.0	4
S2176.0	6.00	6.00	31.00	75.0	4
S2178.0	8.00	8.00	31.00	75.0	4
S21710.0	10.00	10.00	31.00	75.0	4
S21712.0	12.00	12.00	50.00	100.0	4
S21714.0	14.00	14.00	57.00	125.0	4
S21716.0	16.00	16.00	57.00	125.0	4
S21718.0	18.00	18.00	57.00	125.0	4
S21720.0	20.00	20.00	57.00	125.0	4



S218



4-Flute Solid Carbide End Mill, Extra Long Series

Extra long cut length, 4-flute design provides high rigidity for profile milling extra deep walls. AlTiN coating increases tool life and improves performance when milling difficult to machine materials. The 40° helix is designed for high performance machining.

HM	N	NOF 4
	λ 40°	γ 3°
DIN 6535HA	AlTiN	DC h9
	DORMER	

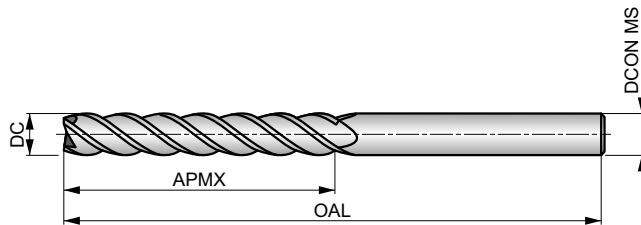

Workpiece material group suitability, starting values for cutting speed (m/min) and Alpha Code. Tables with feed per tooth and correction factors can be found starting from page 112.

P4.3	M2.3	M3.3	M4.1	M4.2	S1.3	S2.2	S3.2	S4.2
■ 40 J	■ 40 J	■ 41 I	■ 40 I	■ 34 I	■ 29 I	■ 24 I	■ 17 I	■ 14 I

DCON MS tolerance h6.

Product	DC [mm]	DCON MS [mm]	APMX [mm]	OAL [mm]	NOF
S2183.0	3.00	3.00	25.00	100.0	4
S2184.0	4.00	4.00	31.00	100.0	4
S2185.0	5.00	5.00	31.00	100.0	4
S2186.0	6.00	6.00	38.00	100.0	4
S2188.0	8.00	8.00	41.00	100.0	4
S21810.0	10.00	10.00	57.00	125.0	4
S21812.0	12.00	12.00	75.00	150.0	4
S21814.0	14.00	14.00	75.00	150.0	4
S21816.0	16.00	16.00	75.00	150.0	4
S21818.0	18.00	18.00	75.00	150.0	4
S21820.0	20.00	20.00	75.00	150.0	4



S219



4-Flute Solid Carbide End Mill, Long Reach

Extra short cut length, 4-flute design provides high rigidity for milling and profiling in hard to reach areas. Neck recess to avoid work contact with the wall. AlTiN coating increases tool life and improves performance when milling difficult to machine materials. The 40° helix is designed for high performance machining.

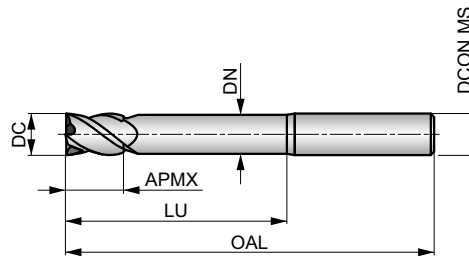

HM	N	NOF 4
	λ 40°	γ 3°
DIN 6535HA	AlTiN	DC h9
	DORMER	



Workpiece material group suitability, starting values for cutting speed (m/min) and Alpha Code. Tables with feed per tooth and correction factors can be found starting from page 112.

P4.3	M2.3	M3.3	M4.1	M4.2	S1.3	S2.2	S3.2	S4.2
■ 64 J	■ 64 J	■ 65 I	■ 64 I	■ 54 I	■ 46 I	■ 38 I	■ 26 I	■ 22 I

DCON MS tolerance h6.

Product	DC	DCON MS	APMX	OAL	NOF	LU	DN
	[mm]	[mm]	[mm]	[mm]		[mm]	[mm]
S2193.0	3.00	3.00	5.00	60.0	4	30.00	2.80
S2194.0	4.00	4.00	8.00	60.0	4	32.00	3.70
S2195.0	5.00	5.00	9.00	60.0	4	32.00	4.60
S2196.0	6.00	6.00	10.00	75.0	4	40.00	5.50
S2198.0	8.00	8.00	12.00	75.0	4	40.00	7.40
S21910.0	10.00	10.00	14.00	75.0	4	40.00	9.20
S21912.0	12.00	12.00	16.00	100.0	4	60.00	11.00
S21914.0	14.00	14.00	22.00	125.0	4	85.00	13.00
S21916.0	16.00	16.00	22.00	125.0	4	85.00	15.00
S21918.0	18.00	18.00	26.00	125.0	4	85.00	17.00
S21920.0	20.00	20.00	26.00	125.0	4	85.00	19.00



S225



Multi-Flute Solid Carbide Finishing End Mill

Short cut length, 6 or 8 flute design provides high rigidity for profile finishing of deep walls. Neck recess to avoid work contact with the wall and extend reach. AlTiN coating increases tool life and improves performance when milling difficult to machine materials. The 50° helix is designed for high surface finish quality.

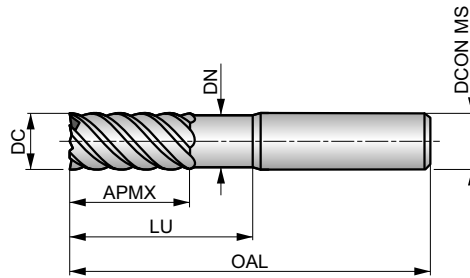

HM	N	NOF 6-8
	λ 50°	γ 3°
DIN 6535HA	AlTiN	DC h9
	DORMER	



Workpiece material group suitability, starting values for cutting speed (m/min) and Alpha Code. Tables with feed per tooth and correction factors can be found starting from page 112.

P4.3 ■ 80 G	M2.3 ■ 80 G	M3.3 ■ 82 F	M4.1 ■ 80 F	M4.2 ■ 68 F	S1.3 ■ 58 F	S2.2 ■ 47 F	S3.2 ■ 33 F	S4.2 ■ 27 F
-----------------------	-----------------------	-----------------------	-----------------------	-----------------------	-----------------------	-----------------------	-----------------------	-----------------------

DCON MS tolerance h6.

Product	DC [mm]	DCON MS [mm]	APMX [mm]	OAL [mm]	NOF	LU [mm]	DN [mm]
S2253.0	3.00	6.00	8.00	50.0	6	20.00	2.80
S2254.0	4.00	6.00	11.00	50.0	6	20.00	3.70
S2256.0	6.00	6.00	15.00	50.0	6	20.00	5.50
S2258.0	8.00	8.00	20.00	64.0	6	30.00	7.40
S22510.0	10.00	10.00	22.00	70.0	6	32.00	9.20
S22512.0	12.00	12.00	25.00	75.0	6	37.00	11.00
S22514.0	14.00	14.00	30.00	90.0	6	44.00	13.00
S22516.0	16.00	16.00	30.00	90.0	8	46.00	15.00
S22518.0	18.00	18.00	35.00	100.0	8	53.00	17.00
S22520.0	20.00	20.00	38.00	100.0	8	58.00	19.00



S226



Multi-Flute Solid Carbide Finishing End Mill, Long Series

Long cut length, 6 or 8 flute design provides high rigidity for finishing of deeper walls. Neck recess to avoid work contact with the wall and extend reach. AlTiN coating increases service life and improves performance when milling difficult to machine materials. The 50° helix is designed for high surface finish quality.

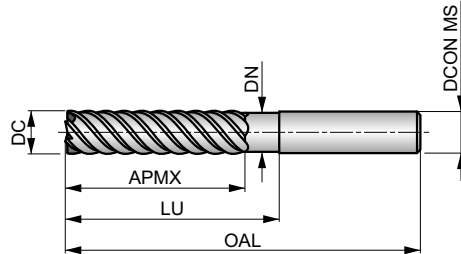

HM	N	NOF 6-8
	λ 50°	γ 3°
DIN 6535HA	AlTiN	DC h9
	DORMER	



Workpiece material group suitability, starting values for cutting speed (m/min) and Alpha Code. Tables with feed per tooth and correction factors can be found starting from page 112.

P4.3	M2.3	M3.3	M4.1	M4.2	S1.3	S2.2	S3.2	S4.2
■ 64 G	■ 64 G	■ 65 F	■ 64 F	■ 54 F	■ 46 F	■ 38 F	■ 26 F	■ 22 F

DCON MS tolerance h6.

Product	DC [mm]	DCON MS [mm]	APMX [mm]	OAL [mm]	NOF	LU [mm]	DN [mm]
S2263.0	3.00	6.00	19.00	75.0	6	30.00	2.80
S2264.0	4.00	6.00	19.00	75.0	6	32.00	3.70
S2266.0	6.00	6.00	31.00	75.0	6	40.00	5.50
S2268.0	8.00	8.00	31.00	75.0	6	40.00	7.40
S22610.0	10.00	10.00	45.00	100.0	6	60.00	9.20
S22612.0	12.00	12.00	50.00	100.0	6	60.00	11.00
S22614.0	14.00	14.00	57.00	125.0	6	85.00	13.00
S22616.0	16.00	16.00	57.00	125.0	8	85.00	15.00
S22618.0	18.00	18.00	57.00	125.0	8	85.00	17.00
S22620.0	20.00	20.00	57.00	125.0	8	85.00	19.00



S227

DORMER



Multi-Flute Solid Carbide Finishing End Mill, Extra Long Series

Extra long cut length, 6 or 8 flute design provides high rigidity for finishing of extra deep walls. Neck recess to avoid work contact with the wall and extend reach. AlTiN coating increases tool life and improves performance when milling difficult to machine materials. The 50° helix is designed for high surface finish quality.

HM	N	NOF 6-8
	λ 50°	γ 3°
DIN 6535HA	AlTiN	DC h9
	DORMER	

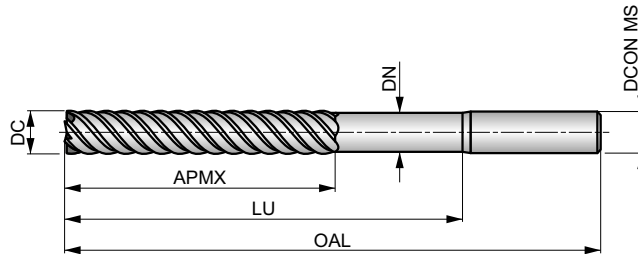

Workpiece material group suitability, starting values for cutting speed (m/min) and Alpha Code. Tables with feed per tooth and correction factors can be found starting from page 112.

P4.3 ■ 40 G	M2.3 ■ 40 G	M3.3 ■ 41 F	M4.1 ■ 40 F	M4.2 ■ 34 F	S1.3 ■ 29 F	S2.2 ■ 24 F	S3.2 ■ 17 F	S4.2 ■ 14 F
-----------------------	-----------------------	-----------------------	-----------------------	-----------------------	-----------------------	-----------------------	-----------------------	-----------------------

DCON MS tolerance h6.

Product	DC [mm]	DCON MS [mm]	APMX [mm]	OAL [mm]	NOF	LU [mm]	DN [mm]
S2276.0	6.00	6.00	38.00	100.0	6	60.00	5.50
S2278.0	8.00	8.00	41.00	100.0	6	60.00	7.40
S22710.0	10.00	10.00	57.00	125.0	6	85.00	9.20
S22712.0	12.00	12.00	75.00	150.0	6	110.00	11.00
S22714.0	14.00	14.00	75.00	150.0	6	110.00	13.00
S22716.0	16.00	16.00	75.00	150.0	8	110.00	15.00
S22718.0	18.00	18.00	75.00	150.0	8	110.00	17.00
S22720.0	20.00	20.00	75.00	150.0	8	110.00	19.00



S229



2-Flute Solid Carbide Ball-Nosed End Mill

Extra short cut length, 2-flute design with neck recess reduces vibrations and provides high rigidity. Ball nosed geometry is designed for high performance contouring of complex surfaces. TiSiN coating increases service life of the milling cutter and improves performance when milling difficult to machine materials.

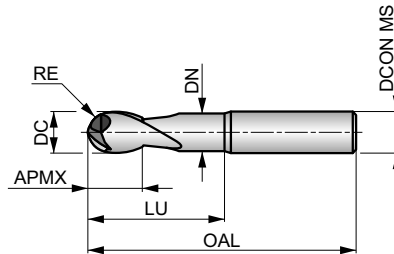

HM	N	NOF 2
	λ 30°	γ 3°
DIN 6535HA	TiSiN	DC h9



Workpiece material group suitability, starting values for cutting speed (m/min) and Alpha Code. Tables with feed per tooth and correction factors can be found starting from page 112.

P4.3	M2.3	M3.3	M4.1	M4.2	S1.3	S2.2	S3.2	S4.2
■ 80 F	■ 80 F	■ 82 F	■ 80 F	■ 68 F	■ 58 F	■ 47 F	■ 33 F	■ 27 F

DCON MS tolerance h6; RE +/-0.02 mm.

Product	DC [mm]	RE [mm]	DCON MS [mm]	APMX [mm]	OAL [mm]	NOF	LU [mm]	DN [mm]
S2291.5XD4	1.50	0.75	4.00	3.00	50.0	2	6.00	1.40
S2292.0XD3	2.00	1.00	3.00	4.00	50.0	2	8.00	1.90
S2292.0XD4	2.00	1.00	4.00	4.00	50.0	2	8.00	1.90
S2293.0XD3	3.00	1.50	3.00	5.00	50.0	2	14.00	2.80
S2293.0XD6	3.00	1.50	6.00	5.00	50.0	2	14.00	2.80
S2294.0XD4	4.00	2.00	4.00	8.00	50.0	2	20.00	3.70
S2294.0XD6	4.00	2.00	6.00	8.00	50.0	2	20.00	3.70
S2295.0XD5	5.00	2.50	5.00	9.00	50.0	2	20.00	4.60
S2295.0XD6	5.00	2.50	6.00	9.00	50.0	2	20.00	4.60
S2296.0	6.00	3.00	6.00	10.00	50.0	2	20.00	5.50
S2298.0	8.00	4.00	8.00	12.00	64.0	2	30.00	7.40
S22910.0	10.00	5.00	10.00	14.00	70.0	2	32.00	9.20
S22912.0	12.00	6.00	12.00	16.00	75.0	2	38.00	11.00
S22914.0	14.00	7.00	14.00	32.00	90.0	2	44.00	13.00
S22916.0	16.00	8.00	16.00	32.00	90.0	2	46.00	15.00



S231



2-Flute Solid Carbide Ball-Nosed End Mill, Long Reach

Extra short cut length, long reach, 2-flute design with neck recess provides high rigidity and reduces vibrations. Ball nosed geometry is designed for high performance contouring of complex surfaces. TiSiN coating increases tool life and improves performance when milling difficult to machine materials.

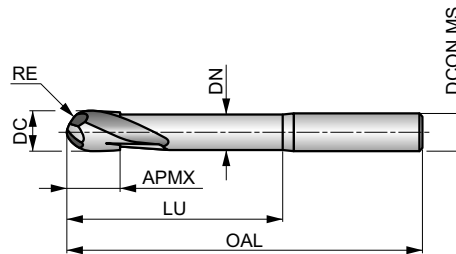

HM	N	NOF 2
	λ 30°	γ 3°
DIN 6535HA	TiSiN	DC h9



Workpiece material group suitability, starting values for cutting speed (m/min) and Alpha Code. Tables with feed per tooth and correction factors can be found starting from page 112.

P4.3 ■ 64 F	M2.3 ■ 64 F	M3.3 ■ 65 F	M4.1 ■ 64 F	M4.2 ■ 54 F	S1.3 ■ 46 F	S2.2 ■ 38 F	S3.2 ■ 26 F	S4.2 ■ 22 F
-----------------------	-----------------------	-----------------------	-----------------------	-----------------------	-----------------------	-----------------------	-----------------------	-----------------------

DCON MS tolerance h6; RE +0/-0.02 mm.

Product	DC [mm]	RE [mm]	DCON MS [mm]	APMX [mm]	OAL [mm]	NOF	LU [mm]	DN [mm]
S2311.5XD4	1.50	0.75	4.00	3.00	75.0	2	10.00	1.40
S2312.0XD3	2.00	1.00	3.00	4.00	60.0	2	14.00	1.90
S2312.0XD4	2.00	1.00	4.00	4.00	75.0	2	14.00	1.90
S2313.0XD3	3.00	1.50	3.00	5.00	60.0	2	21.00	2.80
S2313.0XD6	3.00	1.50	6.00	5.00	75.0	2	21.00	2.80
S2314.0XD4	4.00	2.00	4.00	8.00	60.0	2	28.00	3.70
S2314.0XD6	4.00	2.00	6.00	8.00	75.0	2	28.00	3.70
S2315.0	5.00	2.50	5.00	9.00	60.0	2	32.00	4.60
S2316.0	6.00	3.00	6.00	10.00	75.0	2	40.00	5.50
S2318.0	8.00	4.00	8.00	10.00	75.0	2	40.00	7.40
S23110.0	10.00	5.00	10.00	12.00	75.0	2	40.00	9.20
S23112.0	12.00	6.00	12.00	16.00	100.0	2	60.00	11.00
S23116.0	16.00	8.00	16.00	32.00	125.0	2	80.00	15.00



S233



2-Flute Solid Carbide Ball-Nosed End Mill, Extra Long Reach

Extra short cut length, extra long reach, 2-flute design with neck recess provides high rigidity and reduces vibrations. Ball nosed geometry is designed for high performance contouring of complex surfaces. TiSiN coating increases tool life and improves performance when milling difficult to machine materials.

HM	N	NOF 2
	λ 30°	γ 3°
DIN 6535HA	TiSiN	DC h9
	DORMER	

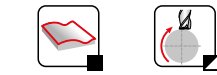
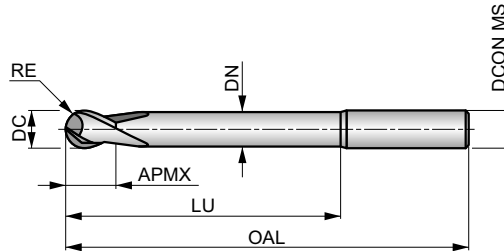

Workpiece material group suitability, starting values for cutting speed (m/min) and Alpha Code. Tables with feed per tooth and correction factors can be found starting from page 112.

P4.3	M2.3	M3.3	M4.1	M4.2	S1.3	S2.2	S3.2	S4.2
■ 40 F	■ 40 F	■ 41 F	■ 40 F	■ 34 F	■ 29 F	■ 24 F	■ 17 F	■ 14 F

DCON MS tolerance h6; RE +0/-0.02 mm.

Product	DC	RE	DCON MS	APMX	OAL	NOF	LU	DN
	[mm]	[mm]	[mm]	[mm]	[mm]		[mm]	[mm]
S2332.0XD3	2.00	1.00	3.00	4.00	100.0	2	20.00	1.90
S2332.0XD4	2.00	1.00	4.00	4.00	100.0	2	20.00	1.90
S2333.0XD3	3.00	1.50	3.00	5.00	100.0	2	30.00	2.80
S2333.0XD6	3.00	1.50	6.00	5.00	100.0	2	30.00	2.80
S2334.0XD4	4.00	2.00	4.00	8.00	100.0	2	40.00	3.70
S2334.0XD6	4.00	2.00	6.00	8.00	100.0	2	40.00	3.70
S2335.0	5.00	2.50	5.00	9.00	100.0	2	50.00	4.60
S2336.0	6.00	3.00	6.00	10.00	100.0	2	60.00	5.50
S2338.0	8.00	4.00	8.00	12.00	100.0	2	60.00	7.40
S23310.0	10.00	5.00	10.00	14.00	125.0	2	85.00	9.20
S23312.0	12.00	6.00	12.00	16.00	125.0	2	85.00	11.00
S23314.0	14.00	7.00	14.00	32.00	150.0	2	110.00	13.00
S23316.0	16.00	8.00	16.00	32.00	150.0	2	110.00	15.00



S260



4-Flute Solid Carbide End Mill

Short cut length, 4-flute design provides high rigidity for standard profile milling. AlCrN coating improves performance and extends the tool life when milling difficult to machine materials. The 40° helix with differential pitch reduces vibrations and maximizes productivity and tool life.

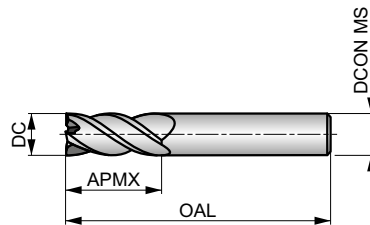

HM	N	NOF 4#
	λ 40°	γ 4°
DIN 6535HA	AlCrN	DC h9
	DORMER	



Workpiece material group suitability, starting values for cutting speed (m/min) and Alpha Code. Tables with feed per tooth and correction factors can be found starting from page 112.

P4.3 ■ 97 J	M2.3 ■ 97 J	M3.3 ■ 99 I	M4.1 ■ 97 I	M4.2 ■ 83 I	S1.3 ■ 70 I	S2.2 ■ 56 I	S3.2 ■ 40 I	S4.2 ■ 32 I	H1.1 ■ 179 I	H2.1 ■ 106 G	H3.1 ■ 118 G	H3.2 ■ 97 G
-----------------------	-----------------------	-----------------------	-----------------------	-----------------------	-----------------------	-----------------------	-----------------------	-----------------------	------------------------	------------------------	------------------------	-----------------------

DCON MS tolerance h6.

Product	DC [mm]	DCON MS [mm]	APMX [mm]	OAL [mm]	NOF
S2603.0	3.00	6.00	9.00	57.0	4
S2604.0	4.00	6.00	12.00	57.0	4
S2605.0	5.00	6.00	13.00	57.0	4
S2606.0	6.00	6.00	13.00	57.0	4
S2608.0	8.00	8.00	20.00	64.0	4
S26010.0	10.00	10.00	22.00	72.0	4
S26012.0	12.00	12.00	26.00	83.0	4
S26014.0	14.00	14.00	32.00	83.0	4
S26016.0	16.00	16.00	32.00	92.0	4
S26018.0	18.00	18.00	38.00	92.0	4
S26020.0	20.00	20.00	38.00	104.0	4



S262



4-Flute Solid Carbide Corner Radius End Mill

Short cut length, 4-flute design with different corner radius available provides high rigidity for standard profile milling when corner radius is required. AlCrN coating improves performance when milling difficult to machine materials. The 40° helix with differential pitch reduces vibrations and maximizes productivity.

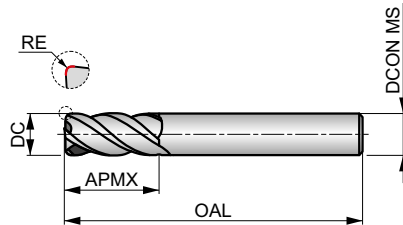

HM	N	NOF 4±
	λ 40°	γ 4°
DIN 6535HA	AlCrN	DC h9
	DORMER	



Workpiece material group suitability, starting values for cutting speed (m/min) and Alpha Code. Tables with feed per tooth and correction factors can be found starting from page 112.

P4.3 ■ 97 J	M2.3 ■ 97 J	M3.3 ■ 99 I	M4.1 ■ 97 I	M4.2 ■ 83 I	S1.3 ■ 70 I	S2.2 ■ 56 I	S3.2 ■ 40 I	S4.2 ■ 32 I	H1.1 ■ 179 I	H2.1 ■ 106 G	H3.1 ■ 118 G	H3.2 ■ 97 G
-----------------------	-----------------------	-----------------------	-----------------------	-----------------------	-----------------------	-----------------------	-----------------------	-----------------------	------------------------	------------------------	------------------------	-----------------------

DCON MS tolerance h6; RE ±0.01 mm.

Product	DC [mm]	RE [mm]	DCON MS [mm]	APMX [mm]	OAL [mm]	NOF
S2623.0XR0.3	3.00	0.30	6.00	9.00	50.0	4
S2623.0XR0.5	3.00	0.50	6.00	9.00	50.0	4
S2624.0XR0.3	4.00	0.30	6.00	12.00	57.0	4
S2624.0XR0.5	4.00	0.50	6.00	12.00	57.0	4
S2624.0XR1.0	4.00	1.00	6.00	12.00	57.0	4
S2625.0XR0.3	5.00	0.30	6.00	15.00	57.0	4
S2625.0XR0.5	5.00	0.50	6.00	15.00	57.0	4
S2626.0XR0.3	6.00	0.30	6.00	16.00	57.0	4
S2626.0XR0.5	6.00	0.50	6.00	16.00	57.0	4
S2626.0XR1.0	6.00	1.00	6.00	16.00	57.0	4
S2628.0XR0.3	8.00	0.30	8.00	20.00	64.0	4
S2628.0XR0.5	8.00	0.50	8.00	20.00	64.0	4
S2628.0XR1.0	8.00	1.00	8.00	20.00	64.0	4
S2628.0XR1.5	8.00	1.50	8.00	20.00	64.0	4
S2628.0XR2.0	8.00	2.00	8.00	20.00	64.0	4
S26210.0XR0.3	10.00	0.30	10.00	22.00	72.0	4
S26210.0XR0.5	10.00	0.50	10.00	22.00	72.0	4
S26210.0XR1.0	10.00	1.00	10.00	22.00	72.0	4
S26210.0XR1.5	10.00	1.50	10.00	22.00	72.0	4
S26210.0XR2.0	10.00	2.00	10.00	22.00	72.0	4
S26212.0XR0.3	12.00	0.30	12.00	26.00	83.0	4
S26212.0XR0.5	12.00	0.50	12.00	26.00	83.0	4
S26212.0XR1.0	12.00	1.00	12.00	26.00	83.0	4
S26212.0XR2.0	12.00	2.00	12.00	26.00	83.0	4
S26212.0XR2.5	12.00	2.50	12.00	26.00	83.0	4
S26212.0XR3.0	12.00	3.00	12.00	26.00	83.0	4
S26214.0XR0.3	14.00	0.30	14.00	32.00	83.0	4
S26214.0XR0.5	14.00	0.50	14.00	32.00	83.0	4
S26214.0XR1.0	14.00	1.00	14.00	32.00	83.0	4
S26214.0XR2.0	14.00	2.00	14.00	32.00	83.0	4
S26214.0XR3.0	14.00	3.00	14.00	32.00	83.0	4



Product	DC	RE	DCON MS	APMX	OAL	NOF
	[mm]	[mm]	[mm]	[mm]	[mm]	
S26216.0XR0.3	16.00	0.30	16.00	32.00	92.0	4
S26216.0XR0.5	16.00	0.50	16.00	32.00	92.0	4
S26216.0XR1.0	16.00	1.00	16.00	32.00	92.0	4
S26216.0XR2.0	16.00	2.00	16.00	32.00	92.0	4
S26216.0XR2.5	16.00	2.50	16.00	32.00	92.0	4
S26216.0XR3.0	16.00	3.00	16.00	32.00	92.0	4
S26216.0XR4.0	16.00	4.00	16.00	32.00	92.0	4
S26218.0XR0.3	18.00	0.30	18.00	38.00	92.0	4
S26218.0XR0.5	18.00	0.50	18.00	38.00	92.0	4
S26218.0XR1.0	18.00	1.00	18.00	38.00	92.0	4
S26218.0XR2.0	18.00	2.00	18.00	38.00	92.0	4
S26218.0XR3.0	18.00	3.00	18.00	38.00	92.0	4
S26220.0XR0.3	20.00	0.30	20.00	38.00	104.0	4
S26220.0XR0.5	20.00	0.50	20.00	38.00	104.0	4
S26220.0XR1.0	20.00	1.00	20.00	38.00	104.0	4
S26220.0XR2.0	20.00	2.00	20.00	38.00	104.0	4
S26220.0XR2.5	20.00	2.50	20.00	38.00	104.0	4
S26220.0XR3.0	20.00	3.00	20.00	38.00	104.0	4
S26220.0XR4.0	20.00	4.00	20.00	38.00	104.0	4



S264



4-Flute Solid Carbide Roughing End Mill

Short cut length, 4-flute with HRA profile to break-up the chips for efficient roughing applications. AlCrN coating improves performance and extends the tool life when milling difficult to machine materials. The 40° helix with differential pitch reduces vibrations and maximizes productivity and tool life.

HM	HRA	NOF 4±
	λ 40°	γ 4°
DIN 6535HB	AlCrN	DC h9

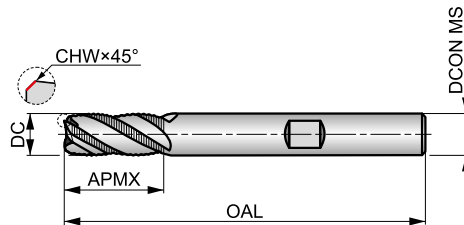

Workpiece material group suitability, starting values for cutting speed (m/min) and Alpha Code. Tables with feed per tooth and correction factors can be found starting from page 112.

P4.3 ■ 97 J	M2.3 ■ 97 J	M3.3 ■ 99 I	M4.1 ■ 97 I	M4.2 ■ 83 I	S1.3 ■ 70 I	S2.2 ■ 56 I	S3.2 ■ 40 I	S4.2 ■ 32 I	H1.1 ■ 179 I	H2.1 ■ 106 G	H3.1 ■ 118 G	H3.2 ■ 97 G
-----------------------	-----------------------	-----------------------	-----------------------	-----------------------	-----------------------	-----------------------	-----------------------	-----------------------	------------------------	------------------------	------------------------	-----------------------

DCON MS tolerance h6; CHW ± 0.02X45° mm.

Product	DC [mm]	CHW [mm]	DCON MS [mm]	APMX [mm]	OAL [mm]	NOF
S2646.0	6.00	0.10	6.00	13.00	57.0	4
S2648.0	8.00	0.20	8.00	20.00	64.0	4
S26410.0	10.00	0.20	10.00	22.00	72.0	4
S26412.0	12.00	0.20	12.00	26.00	83.0	4
S26414.0	14.00	0.30	14.00	26.00	83.0	4
S26416.0	16.00	0.30	16.00	32.00	92.0	4
S26418.0	18.00	0.30	18.00	32.00	92.0	4
S26420.0	20.00	0.40	20.00	38.00	104.0	4



S521



4-Flute Solid Carbide Corner Radius End Mill

Extra short cut length, 4-flute design with different corner radius available and neck recess provides high rigidity for milling contours when corner radius is required. TiSiN coating improves performance and 45° helix is designed for high performance machining in hardened materials up to 63HRC.

HM	N	NOF 4
	λ 45°	γ -10°
DIN 6535HA	TiSiN	DC h9

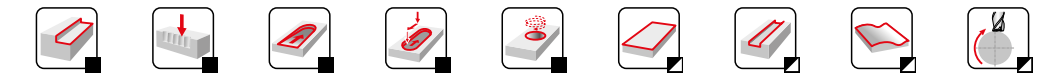
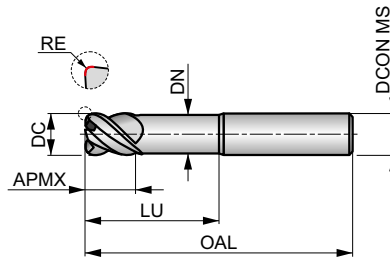

Workpiece material group suitability, starting values for cutting speed (m/min) and Alpha Code. Tables with feed per tooth and correction factors can be found starting from page 112.

H1.1 ■ 119 I	H2.1 ■ 70 G	H2.2 ■ 60 E	H3.1 ■ 78 G	H3.2 ■ 64 G	H4.1 ■ 50 E	H4.2 ■ 42 B
------------------------	-----------------------	-----------------------	-----------------------	-----------------------	-----------------------	-----------------------

DCON MS tolerance h6; RE ±0.01 mm.

Product	DC [mm]	RE [mm]	DCON MS [mm]	APMX [mm]	OAL [mm]	NOF	LU [mm]	DN [mm]
S5213.0XR0.3	3.00	0.30	6.00	4.00	60.0	4	14.00	2.80
S5214.0XR0.3	4.00	0.30	6.00	5.00	60.0	4	16.00	3.70
S5214.0XR0.5	4.00	0.50	6.00	5.00	60.0	4	16.00	3.70
S5215.0XR0.3	5.00	0.30	6.00	6.00	60.0	4	18.00	4.60
S5215.0XR0.5	5.00	0.50	6.00	6.00	60.0	4	18.00	4.60
S5216.0XR0.5	6.00	0.50	6.00	7.00	60.0	4	20.00	5.50
S5216.0XR1.0	6.00	1.00	6.00	7.00	60.0	4	20.00	5.50
S5218.0XR0.5	8.00	0.50	8.00	9.00	64.0	4	26.00	7.40
S5218.0XR1.0	8.00	1.00	8.00	9.00	64.0	4	26.00	7.40
S52110.0XR1.0	10.00	1.00	10.00	11.00	70.0	4	31.00	9.20
S52110.0XR2.0	10.00	2.00	10.00	11.00	70.0	4	31.00	9.20
S52112.0XR1.0	12.00	1.00	12.00	13.00	75.0	4	37.00	11.00
S52112.0XR2.0	12.00	2.00	12.00	13.00	75.0	4	37.00	11.00
S52116.0XR1.0	16.00	1.00	16.00	17.00	90.0	4	43.00	15.00
S52116.0XR2.0	16.00	2.00	16.00	17.00	90.0	4	43.00	15.00
S52116.0XR3.0	16.00	3.00	16.00	17.00	90.0	4	43.00	15.00



S523



4-Flute Solid Carbide Corner Radius End Mill

Short cut length, 4-flute design with different corner radius available provides high rigidity for standard profile milling where a corner radius is required. TiSiN coating improves performance and 40° helix is designed for high performance machining in hardened materials up to 63HRC.

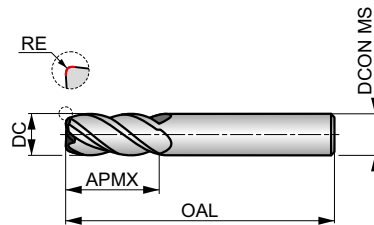

HM	N	NOF 4
	40°	-6°
DIN 6535HA	TiSiN	DC h9

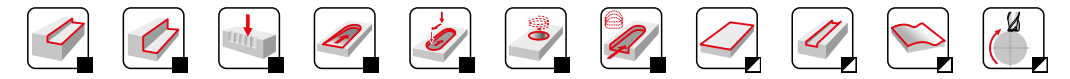

Workpiece material group suitability, starting values for cutting speed (m/min) and Alpha Code. Tables with feed per tooth and correction factors can be found starting from page 112.

H1.1 ■ 119 I	H2.1 ■ 70 G	H2.2 ■ 60 E	H3.1 ■ 78 G	H3.2 ■ 64 G	H4.1 ■ 50 E	H4.2 ■ 42 B
------------------------	-----------------------	-----------------------	-----------------------	-----------------------	-----------------------	-----------------------

DCON MS tolerance h6; RE ±0.01 mm.

Product	DC [mm]	RE [mm]	DCON MS [mm]	APMX [mm]	OAL [mm]	NOF
S5231.5XR0.2	1.50	0.20	6.00	4.50	50.0	4
S5232.0XR0.2	2.00	0.20	6.00	6.50	50.0	4
S5233.0XR0.2XD3	3.00	0.20	3.00	9.00	50.0	4
S5233.0XR0.3XD3	3.00	0.30	3.00	9.00	50.0	4
S5233.0XR0.2XD6	3.00	0.20	6.00	9.00	50.0	4
S5233.0XR0.3XD6	3.00	0.30	6.00	9.00	50.0	4
S5233.0XR0.5XD6	3.00	0.50	6.00	9.00	50.0	4
S5234.0XR0.3XD4	4.00	0.30	4.00	12.00	50.0	4
S5234.0XR0.5XD4	4.00	0.50	4.00	12.00	50.0	4
S5234.0XR0.3XD6	4.00	0.30	6.00	12.00	50.0	4
S5234.0XR0.5XD6	4.00	0.50	6.00	12.00	50.0	4
S5235.0XR0.3XD5	5.00	0.30	5.00	15.00	50.0	4
S5235.0XR0.5XD5	5.00	0.50	5.00	15.00	50.0	4
S5235.0XR0.3XD6	5.00	0.30	6.00	15.00	50.0	4
S5235.0XR0.5XD6	5.00	0.50	6.00	15.00	50.0	4
S5236.0XR0.3	6.00	0.30	6.00	16.00	50.0	4
S5236.0XR0.5	6.00	0.50	6.00	16.00	50.0	4
S5236.0XR1.0	6.00	1.00	6.00	16.00	50.0	4
S5238.0XR0.3	8.00	0.30	8.00	20.00	64.0	4
S5238.0XR0.5	8.00	0.50	8.00	20.00	64.0	4
S5238.0XR1.0	8.00	1.00	8.00	20.00	64.0	4
S5238.0XR2.0	8.00	2.00	8.00	20.00	64.0	4
S52310.0XR0.5	10.00	0.50	10.00	22.00	70.0	4
S52310.0XR1.0	10.00	1.00	10.00	22.00	70.0	4
S52310.0XR1.5	10.00	1.50	10.00	22.00	70.0	4
S52310.0XR2.0	10.00	2.00	10.00	22.00	70.0	4
S52312.0XR0.5	12.00	0.50	12.00	25.00	75.0	4
S52312.0XR1.0	12.00	1.00	12.00	25.00	75.0	4
S52312.0XR2.0	12.00	2.00	12.00	25.00	75.0	4
S52312.0XR3.0	12.00	3.00	12.00	25.00	75.0	4
S52316.0XR0.5	16.00	0.50	16.00	32.00	90.0	4



Product	DC	RE	DCON MS	APMX	OAL	NOF
	[mm]	[mm]	[mm]	[mm]	[mm]	
S52316.0XR1.0	16.00	1.00	16.00	32.00	90.0	4
S52316.0XR2.0	16.00	2.00	16.00	32.00	90.0	4
S52316.0XR3.0	16.00	3.00	16.00	32.00	90.0	4



S524



4-Flute Solid Carbide Corner Radius End Mill, Long Reach

Extra short cut length, 4-flute design with different corner radius available and 40° helix provides high rigidity for profile milling in hard to reach areas where a corner radius is required. Neck recess to avoid work contact with the wall. TiSiN coating improves performance machining in hardened materials up to 63HRC.

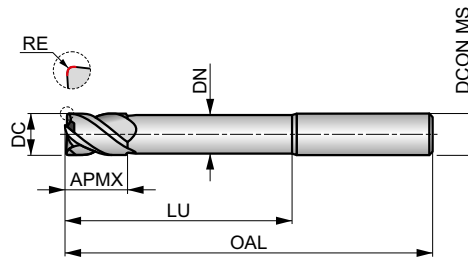

HM	N	NOF 4
	40°	γ -6°
DIN 6535HA	TiSiN	DC h9



Workpiece material group suitability, starting values for cutting speed (m/min) and Alpha Code. Tables with feed per tooth and correction factors can be found starting from page 112.

H1.1 ■ 119 I	H2.1 ■ 70 G	H2.2 ■ 60 E	H3.1 ■ 78 G	H3.2 ■ 64 G	H4.1 ■ 50 E	H4.2 ■ 42 B
------------------------	-----------------------	-----------------------	-----------------------	-----------------------	-----------------------	-----------------------

DCON MS tolerance h6; RE ±0.01 mm.

Product	DC [mm]	RE [mm]	DCON MS [mm]	APMX [mm]	OAL [mm]	NOF	LU [mm]	DN [mm]
S5243.0XR0.3	3.00	0.30	6.00	5.00	75.0	4	30.00	2.80
S5244.0XR0.3	4.00	0.30	6.00	8.00	75.0	4	32.00	3.70
S5244.0XR0.5	4.00	0.50	6.00	8.00	75.0	4	32.00	3.70
S5245.0XR0.3	5.00	0.30	6.00	9.00	75.0	4	32.00	4.60
S5245.0XR0.5	5.00	0.50	6.00	9.00	75.0	4	32.00	4.60
S5246.0XR0.3	6.00	0.30	6.00	10.00	75.0	4	40.00	5.50
S5246.0XR0.5	6.00	0.50	6.00	10.00	75.0	4	40.00	5.50
S5246.0XR1.0	6.00	1.00	6.00	10.00	75.0	4	40.00	5.50
S5248.0XR0.3	8.00	0.30	8.00	12.00	75.0	4	40.00	7.40
S5248.0XR0.5	8.00	0.50	8.00	12.00	75.0	4	40.00	7.40
S5248.0XR1.0	8.00	1.00	8.00	12.00	75.0	4	40.00	7.40
S52410.0XR0.5	10.00	0.50	10.00	14.00	75.0	4	40.00	9.20
S52410.0XR1.0	10.00	1.00	10.00	14.00	75.0	4	40.00	9.20
S52410.0XR2.0	10.00	2.00	10.00	14.00	75.0	4	40.00	9.20
S52412.0XR0.5	12.00	0.50	12.00	16.00	100.0	4	60.00	11.00
S52412.0XR1.0	12.00	1.00	12.00	16.00	100.0	4	60.00	11.00
S52412.0XR2.0	12.00	2.00	12.00	16.00	100.0	4	60.00	11.00
S52416.0XR0.5	16.00	0.50	16.00	22.00	125.0	4	85.00	15.00
S52416.0XR1.0	16.00	1.00	16.00	22.00	125.0	4	85.00	15.00
S52416.0XR2.0	16.00	2.00	16.00	22.00	125.0	4	85.00	15.00
S52416.0XR3.0	16.00	3.00	16.00	22.00	125.0	4	85.00	15.00



S525



Multi-Flute Solid Carbide Finishing End Mill

Short cut length, 6 or 8 flute design with 50° helix provides high rigidity for finishing of deep walls. Neck recess to avoid work contact with the wall and extend reach. TiSiN coating increases tool life and improves performance when milling hardened materials up to 63HRC.

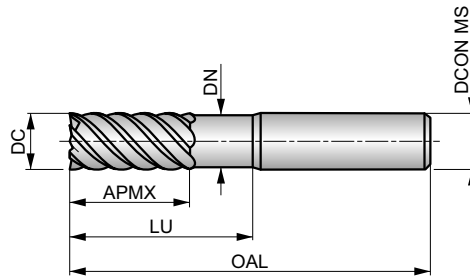

HM	N	NOF 6-8
	λ 50°	γ -26°
DIN 6535HA	TiSiN	DC h9
	DORMER	



Workpiece material group suitability, starting values for cutting speed (m/min) and Alpha Code. Tables with feed per tooth and correction factors can be found starting from page 112.

H1.1 ■ 119 G	H2.1 ■ 70 G	H2.2 ■ 60 E	H3.1 ■ 78 G	H3.2 ■ 64 G	H4.1 ■ 50 E	H4.2 ■ 42 A
------------------------	-----------------------	-----------------------	-----------------------	-----------------------	-----------------------	-----------------------

DCON MS tolerance h6.

Product	DC [mm]	DCON MS [mm]	APMX [mm]	OAL [mm]	NOF	LU [mm]	DN [mm]
S5253.0	3.00	6.00	8.00	50.0	6	20.00	2.80
S5254.0	4.00	6.00	11.00	50.0	6	20.00	3.70
S5256.0	6.00	6.00	15.00	50.0	6	20.00	5.50
S5258.0	8.00	8.00	20.00	64.0	6	30.00	7.40
S52510.0	10.00	10.00	22.00	70.0	6	32.00	9.20
S52512.0	12.00	12.00	25.00	75.0	6	37.00	11.00
S52514.0	14.00	14.00	30.00	90.0	6	44.00	13.00
S52516.0	16.00	16.00	30.00	90.0	8	46.00	15.00
S52518.0	18.00	18.00	35.00	100.0	8	53.00	17.00
S52520.0	20.00	20.00	38.00	100.0	8	58.00	19.00



S526



Multi-Flute Solid Carbide Finishing End Mill, Long Series

Long cut length, 6 or 8 flute design with 50° helix provides high rigidity for finishing of deeper walls. Neck recess to avoid work contact with the wall and extend reach. TiSiN coating increases tool life and improves performance when milling hardened materials up to 63HRC.

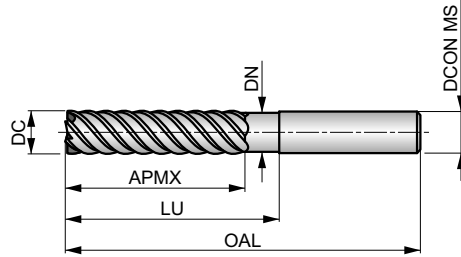

HM	N	NOF 6-8
	λ 50°	γ -26°
DIN 6535HA	TiSiN	DC h9
	DORMER	



Workpiece material group suitability, starting values for cutting speed (m/min) and Alpha Code. Tables with feed per tooth and correction factors can be found starting from page 112.

H1.1 ■ 96 G	H2.1 ■ 57 G	H2.2 ■ 49 E	H3.1 ■ 63 G	H3.2 ■ 52 G	H4.1 ■ 40 E	H4.2 ■ 34 A
-----------------------	-----------------------	-----------------------	-----------------------	-----------------------	-----------------------	-----------------------

DCON MS tolerance h6.

Product	DC [mm]	DCON MS [mm]	APMX [mm]	OAL [mm]	NOF	LU [mm]	DN [mm]
S5263.0	3.00	6.00	19.00	75.0	6	30.00	2.80
S5264.0	4.00	6.00	19.00	75.0	6	32.00	3.70
S5266.0	6.00	6.00	31.00	75.0	6	40.00	5.50
S5268.0	8.00	8.00	31.00	75.0	6	40.00	7.40
S52610.0	10.00	10.00	45.00	100.0	6	60.00	9.20
S52612.0	12.00	12.00	50.00	100.0	6	60.00	11.00
S52614.0	14.00	14.00	57.00	125.0	6	85.00	13.00
S52616.0	16.00	16.00	57.00	125.0	8	85.00	15.00
S52618.0	18.00	18.00	57.00	125.0	8	85.00	17.00
S52620.0	20.00	20.00	57.00	125.0	8	85.00	19.00



S527



Multi-Flute Solid Carbide Finishing End Mill, Extra Long Series

Extra long cut length, 6 or 8 flute design with 50° helix provides high rigidity for finishing of extra deep walls. Neck recess to avoid work contact with the wall and extend reach. TiSiN coating increases service life and improves performance when milling hardened materials up to 63HRC.

HM	N	NOF 6-8
	λ 50°	γ -26°
 DIN 6535HA	 TiSiN	DC h9
	DORMER	

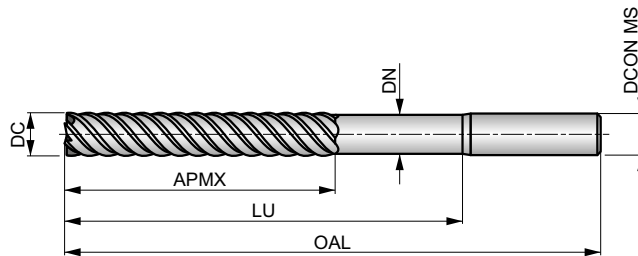

Workpiece material group suitability, starting values for cutting speed (m/min) and Alpha Code. Tables with feed per tooth and correction factors can be found starting from page 112.

H1.1 ■ 59 G	H2.1 ■ 35 G	H2.2 ■ 30 E	H3.1 ■ 39 G	H3.2 ■ 32 G	H4.1 ■ 25 E	H4.2 ■ 21 A
-----------------------	-----------------------	-----------------------	-----------------------	-----------------------	-----------------------	-----------------------

DCON MS tolerance h6.

Product	DC [mm]	DCON MS [mm]	APMX [mm]	OAL [mm]	NOF	LU [mm]	DN [mm]
S5273.0	3.00	6.00	25.00	100.0	6	60.00	2.80
S5274.0	4.00	6.00	31.00	100.0	6	60.00	3.70
S5276.0	6.00	6.00	38.00	100.0	6	60.00	5.50
S5278.0	8.00	8.00	41.00	100.0	6	60.00	7.40
S52710.0	10.00	10.00	57.00	125.0	6	85.00	9.20
S52712.0	12.00	12.00	75.00	150.0	6	110.00	11.00
S52716.0	16.00	16.00	75.00	150.0	8	110.00	15.00
S52720.0	20.00	20.00	75.00	150.0	8	110.00	19.00



S529

DORMER



2-Flute Solid Carbide Ball-Nosed End Mill

Extra short cut length, 2-flute design with neck recess provides high rigidity and reduces vibrations. Ball nosed geometry is designed for high performance contouring of complex surfaces. TiSiN coating increases tool life and improves performance when machining hardened materials up to 63HRC.

HM	N	NOF 2
	λ 30°	γ -10°
DIN 6535HA	TiSiN	DC h9
	DORMER	

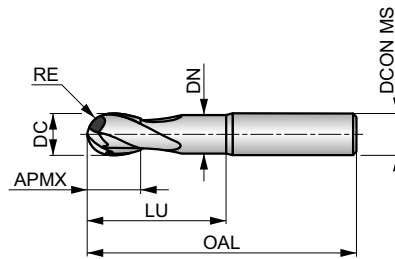

Workpiece material group suitability, starting values for cutting speed (m/min) and Alpha Code. Tables with feed per tooth and correction factors can be found starting from page 112.

H1.1 ■ 119 F	H2.1 ■ 70 E	H2.2 ■ 60 D	H3.1 ■ 78 E	H3.2 ■ 64 E	H4.1 ■ 50 D	H4.2 ■ 42 A
------------------------	-----------------------	-----------------------	-----------------------	-----------------------	-----------------------	-----------------------

DCON MS tolerance h6; RE +/-0.02 mm.

Product	DC [mm]	RE [mm]	DCON MS [mm]	APMX [mm]	OAL [mm]	NOF	LU [mm]	DN [mm]
S5291.5	1.50	0.75	6.00	3.00	50.0	2	6.00	1.40
S5292.0XD4	2.00	1.00	4.00	4.00	50.0	2	8.00	1.90
S5292.0XD6	2.00	1.00	6.00	4.00	50.0	2	8.00	1.90
S5293.0XD3	3.00	1.50	3.00	5.00	50.0	2	14.00	2.80
S5293.0XD6	3.00	1.50	6.00	5.00	50.0	2	14.00	2.80
S5294.0XD4	4.00	2.00	4.00	8.00	50.0	2	20.00	3.70
S5294.0XD6	4.00	2.00	6.00	8.00	50.0	2	20.00	3.70
S5295.0XD5	5.00	2.50	5.00	9.00	50.0	2	20.00	4.60
S5295.0XD6	5.00	2.50	6.00	9.00	50.0	2	20.00	4.60
S5296.0	6.00	3.00	6.00	10.00	50.0	2	20.00	5.50
S5298.0	8.00	4.00	8.00	12.00	64.0	2	30.00	7.40
S52910.0	10.00	5.00	10.00	14.00	70.0	2	32.00	9.20
S52912.0	12.00	6.00	12.00	16.00	75.0	2	38.00	11.00
S52916.0	16.00	8.00	16.00	32.00	90.0	2	46.00	15.00



S531



2-Flute Solid Carbide Ball-Nosed End Mill, Long Reach

Extra short cut length, long reach, 2-flute design with neck recess provides high rigidity and reduces vibrations. Ball nosed geometry is designed for high performance contouring of complex surfaces. TiSiN coating increases tool life and improves performance when machining hardened materials up to 63HRC.

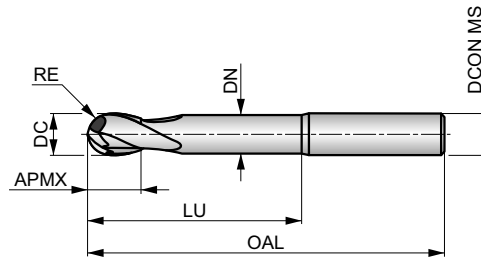

HM	N	NOF 2
	λ 30°	γ -10°
DIN 6535HA	TiSiN	DC h9
	DORMER	



Workpiece material group suitability, starting values for cutting speed (m/min) and Alpha Code. Tables with feed per tooth and correction factors can be found starting from page 112.

H1.1 ■ 96 F	H2.1 ■ 57 E	H2.2 ■ 49 D	H3.1 ■ 63 E	H3.2 ■ 52 E	H4.1 ■ 40 D	H4.2 ■ 34 A
-----------------------	-----------------------	-----------------------	-----------------------	-----------------------	-----------------------	-----------------------

DCON MS tolerance h6; RE +0/-0.02 mm.

Product	DC [mm]	RE [mm]	DCON MS [mm]	APMX [mm]	OAL [mm]	NOF	LU [mm]	DN [mm]
S5311.5	1.50	0.75	6.00	3.00	75.0	2	10.00	1.40
S5312.0XD4	2.00	1.00	4.00	4.00	75.0	2	14.00	1.90
S5312.0XD6	2.00	1.00	6.00	4.00	75.0	2	14.00	1.90
S5313.0XD3	3.00	1.50	3.00	5.00	60.0	2	21.00	2.80
S5313.0XD6	3.00	1.50	6.00	5.00	75.0	2	21.00	2.80
S5314.0XD4	4.00	2.00	4.00	8.00	60.0	2	28.00	3.70
S5314.0XD6	4.00	2.00	6.00	8.00	75.0	2	28.00	3.70
S5315.0XD5	5.00	2.50	5.00	9.00	60.0	2	32.00	4.60
S5315.0XD6	5.00	2.50	6.00	9.00	75.0	2	32.00	4.60
S5316.0	6.00	3.00	6.00	10.00	75.0	2	40.00	5.50
S5318.0	8.00	4.00	8.00	12.00	75.0	2	40.00	7.40
S53110.0	10.00	5.00	10.00	14.00	75.0	2	40.00	9.20
S53112.0	12.00	6.00	12.00	16.00	100.0	2	60.00	11.00
S53116.0	16.00	8.00	16.00	32.00	125.0	2	80.00	15.00



S533



2-Flute Solid Carbide Ball-Nosed End Mill, Extra Long Reach

Extra short cut length, extra long reach, 2-flute design with neck recess provides high rigidity and reduces vibrations. Ball nosed geometry is designed for high performance contouring of complex surfaces. TiSiN coating increases tool life and improves performance when machining hardened materials up to 63HRC.

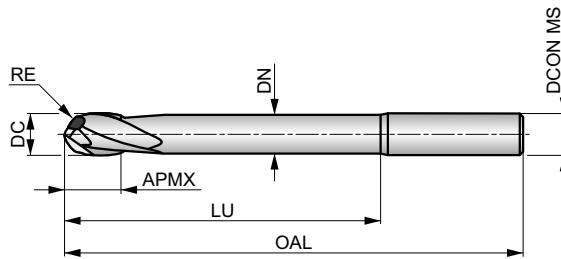

HM	N	NOF 2
	λ 30°	γ -10°
DIN 6535HA	TiSiN	DC h9
	DORMER	

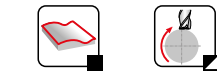

Workpiece material group suitability, starting values for cutting speed (m/min) and Alpha Code. Tables with feed per tooth and correction factors can be found starting from page 112.

H1.1 ■ 59 F	H2.1 ■ 35 E	H2.2 ■ 30 D	H3.1 ■ 39 E	H3.2 ■ 32 E	H4.1 ■ 25 D	H4.2 ■ 21 A
-----------------------	-----------------------	-----------------------	-----------------------	-----------------------	-----------------------	-----------------------

DCON MS tolerance h6; RE +0/-0.02 mm.

Product	DC [mm]	RE [mm]	DCON MS [mm]	APMX [mm]	OAL [mm]	NOF	LU [mm]	DN [mm]
S5332.0XD4	2.00	1.00	4.00	4.00	100.0	2	20.00	1.90
S5332.0XD6	2.00	1.00	6.00	4.00	100.0	2	20.00	1.90
S5333.0XD4	3.00	1.50	4.00	5.00	100.0	2	30.00	2.80
S5333.0XD6	3.00	1.50	6.00	5.00	100.0	2	30.00	2.80
S5334.0XD4	4.00	2.00	4.00	8.00	100.0	2	40.00	3.70
S5334.0XD6	4.00	2.00	6.00	8.00	100.0	2	40.00	3.70
S5335.0XD5	5.00	2.50	5.00	9.00	100.0	2	50.00	4.60
S5335.0XD6	5.00	2.50	6.00	9.00	100.0	2	50.00	4.60
S5336.0	6.00	3.00	6.00	10.00	100.0	2	60.00	5.50
S5338.0	8.00	4.00	8.00	12.00	100.0	2	60.00	7.40
S53310.0	10.00	5.00	10.00	14.00	125.0	2	85.00	9.20
S53312.0	12.00	6.00	12.00	16.00	125.0	2	85.00	11.00
S53314.0	14.00	7.00	14.00	32.00	150.0	2	110.00	13.00
S53316.0	16.00	8.00	16.00	32.00	150.0	2	110.00	15.00



S534

DORMER



4-Flute Solid Carbide Ball-Nosed End Mill

Extra short cut length, 4-flute design with neck recess reduces vibrations and provides high rigidity. Ball nosed geometry is designed for high performance contouring of complex surfaces. TiSiN coating increases tool life and improves performance when machining hardened materials up to 63HRC.

HM	N	NOF 4
	λ 30°	γ -10°
DIN 6535HA	TiSiN	DC h9

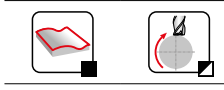
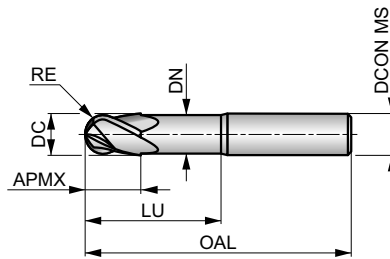

Workpiece material group suitability, starting values for cutting speed (m/min) and Alpha Code. Tables with feed per tooth and correction factors can be found starting from page 112.

H1.1 ■ 119 E	H2.1 ■ 70 D	H2.2 ■ 60 C	H3.1 ■ 78 D	H3.2 ■ 64 D	H4.1 ■ 50 C	H4.2 ■ 42 A
------------------------	-----------------------	-----------------------	-----------------------	-----------------------	-----------------------	-----------------------

DCON MS tolerance h6; RE +0/-0.02 mm.

Product	DC [mm]	RE [mm]	DCON MS [mm]	APMX [mm]	OAL [mm]	NOF	LU [mm]	DN [mm]
S5343.0	3.00	1.50	6.00	5.00	50.0	4	14.00	2.80
S5344.0	4.00	2.00	6.00	8.00	50.0	4	20.00	3.70
S5345.0	5.00	2.50	6.00	9.00	50.0	4	20.00	4.60
S5346.0	6.00	3.00	6.00	10.00	50.0	4	20.00	5.50
S5348.0	8.00	4.00	8.00	12.00	64.0	4	30.00	7.40
S53410.0	10.00	5.00	10.00	14.00	70.0	4	32.00	9.20
S53412.0	12.00	6.00	12.00	16.00	75.0	4	38.00	11.00
S53414.0	14.00	7.00	14.00	32.00	90.0	4	44.00	13.00
S53416.0	16.00	8.00	16.00	32.00	90.0	4	46.00	15.00



S535



4-Flute Solid Carbide Ball-Nosed End Mill, Long Reach

Extra short cut length, long reach, 4-flute design with neck recess reduces vibrations and provides high rigidity. Ball nosed geometry is designed for high performance contouring of complex surfaces. TiSiN coating increases tool life and improves performance when machining hardened materials up to 63HRC.

HM	N	NOF 4
	λ 30°	γ -10°
DIN 6535HA	TiSiN	DC h9

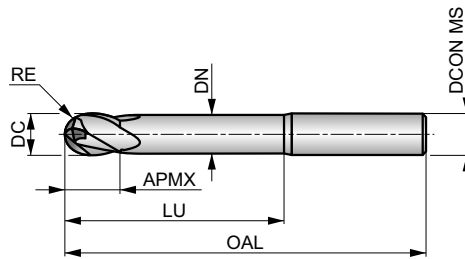

Workpiece material group suitability, starting values for cutting speed (m/min) and Alpha Code. Tables with feed per tooth and correction factors can be found starting from page 112.

H1.1 ■ 96 E	H2.1 ■ 57 D	H2.2 ■ 49 C	H3.1 ■ 63 D	H3.2 ■ 52 D	H4.1 ■ 40 C	H4.2 ■ 34 A
-----------------------	-----------------------	-----------------------	-----------------------	-----------------------	-----------------------	-----------------------

DCON MS tolerance h6; RE +0/-0.02 mm.

Product	DC [mm]	RE [mm]	DCON MS [mm]	APMX [mm]	OAL [mm]	NOF	LU [mm]	DN [mm]
S5353.0	3.00	1.50	6.00	5.00	75.0	4	21.00	2.80
S5354.0	4.00	2.00	6.00	8.00	75.0	4	28.00	3.70
S5355.0	5.00	2.50	6.00	9.00	75.0	4	32.00	4.60
S5356.0	6.00	3.00	6.00	10.00	75.0	4	40.00	5.50
S5358.0	8.00	4.00	8.00	12.00	75.0	4	40.00	7.40
S53510.0	10.00	5.00	10.00	14.00	75.0	4	40.00	9.20
S53512.0	12.00	6.00	12.00	16.00	100.0	4	60.00	11.00
S53514.0	14.00	7.00	14.00	32.00	125.0	4	80.00	13.00
S53516.0	16.00	8.00	16.00	32.00	125.0	4	80.00	15.00



S536



High Feed, Multi-Flute Solid Carbide Corner Radius End Mill

Extra short cut length, 4 or 6 flute design with corner radius, 25° helix and specific geometry for high feed machining in hardened materials up to 63HRC. TiSiN coating increases tool life and improves performance.

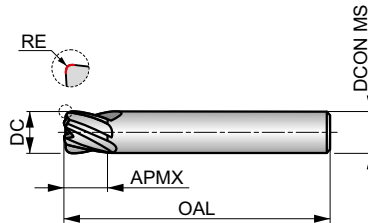

HM	N	NOF 4-6
	λ 25°	γ 0°
DIN 6535HA	TiSiN	DC h9
	DORMER	

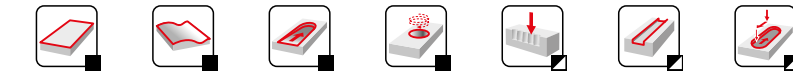

Workpiece material group suitability, starting values for cutting speed (m/min) and Alpha Code. Tables with feed per tooth and correction factors can be found starting from page 112.

H1.1 ■ 205 E	H2.1 ■ 122 E	H2.2 ■ 104 D	H3.1 ■ 135 E	H3.2 ■ 111 E	H4.1 ■ 86 D	H4.2 ■ 73 D
------------------------	------------------------	------------------------	------------------------	------------------------	-----------------------	-----------------------

DCON MS tolerance h6; RE ±0.01 mm.

Product	DC [mm]	RE [mm]	DCON MS [mm]	APMX [mm]	OAL [mm]	NOF
S5366.0XR1.0	6.00	1.00	6.00	6.00	60.0	4
S5368.0XR2.0	8.00	2.00	8.00	8.00	64.0	6
S53610.0XR2.0	10.00	2.00	10.00	10.00	75.0	6
S53612.0XR2.0	12.00	2.00	12.00	12.00	75.0	6



S561



4-Flute Solid Carbide End Mill

Medium cut length, 4-flute design with 40° helix and gash-land to enable milling hard materials up to 70HRC. TiSiN coating improves performance and the differential pitch reduces vibrations, maximizing productivity and tool life. Square end design to produce sharp corners.

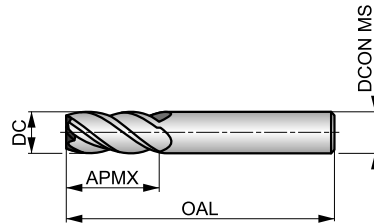
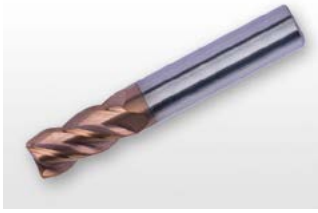

HM	N	NOF 4±
	λ 40°	γ -6°
DIN 6535HA	TiSiN	DC h9
	DORMER	



Workpiece material group suitability, starting values for cutting speed (m/min) and Alpha Code. Tables with feed per tooth and correction factors can be found starting from page 112.

H1.1 ■ 119 I	H2.1 ■ 70 G	H2.2 ■ 60 E	H3.1 ■ 78 G	H3.2 ■ 64 G	H4.1 ■ 50 E	H4.2 ■ 42 B
------------------------	-----------------------	-----------------------	-----------------------	-----------------------	-----------------------	-----------------------

DCON MS tolerance h6.

Product	DC	DCON MS	APMX	OAL	NOF
	[mm]	[mm]	[mm]	[mm]	
S5611.0	1.00	6.00	3.00	50.0	4
S5611.5	1.50	6.00	4.50	50.0	4
S5612.0	2.00	6.00	6.50	50.0	4
S5612.5	2.50	6.00	6.50	50.0	4
S5613.0	3.00	6.00	9.00	50.0	4
S5614.0	4.00	6.00	12.00	50.0	4
S5615.0	5.00	6.00	15.00	50.0	4
S5616.0	6.00	6.00	20.00	60.0	4
S5618.0	8.00	8.00	20.00	64.0	4
S56110.0	10.00	10.00	22.00	70.0	4
S56112.0	12.00	12.00	25.00	75.0	4
S56114.0	14.00	14.00	32.00	90.0	4
S56116.0	16.00	16.00	32.00	90.0	4
S56118.0	18.00	18.00	38.00	100.0	4
S56120.0	20.00	20.00	38.00	100.0	4



S637

DORMER



Single-Flute Solid Carbide End Mill

Short cut length, 1-flute design provides high performance when slotting and routing. The S637, with high hook geometry, is designed for high speed routing in thin walled non-ferrous materials. Polished surface prevents workpiece material from sticking to the cutting edge.

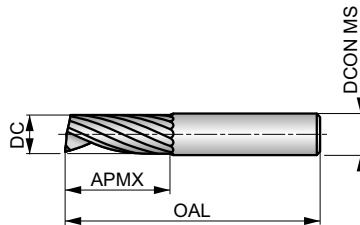

HM	W	NOF 1
	λ 25°	γ 20°
DIN 6535HA	Hi	DC h9
	DORMER	



Workpiece material group suitability, starting values for cutting speed (m/min) and Alpha Code. Tables with feed per tooth and correction factors can be found starting from page 112.

N1.1 ■ 709 R	N1.2 ■ 533 R	N1.3 ■ 357 R	N2.1 ■ 357 P	N2.2 ■ 320 P	N2.3 ■ 229 P	N3.1 ■ 373 P	N3.2 ■ 219 P	N3.3 ■ 112 P	N4.1 ■ 373 S	N4.2 ■ 144 S
------------------------	------------------------	------------------------	------------------------	------------------------	------------------------	------------------------	------------------------	------------------------	------------------------	------------------------

DCON MS tolerance h6.

Product	DC [mm]	DCON MS [mm]	APMX [mm]	OAL [mm]	NOF
S6372.0	2.00	2.00	10.00	40.0	1
S6373.0	3.00	3.00	12.00	40.0	1
S6374.0	4.00	4.00	15.00	50.0	1
S6375.0	5.00	5.00	16.00	50.0	1
S6376.0	6.00	6.00	20.00	60.0	1
S6378.0	8.00	8.00	22.00	63.0	1
S63710.0	10.00	10.00	25.00	72.0	1
S63712.0	12.00	12.00	30.00	83.0	1



S610



2-Flute Solid Carbide End Mill

Short cut length, 2-flute design provides high rigidity for milling standard slots and profiling. The S610, with high hook geometry, is designed for high performance machining in non-ferrous materials. Polished surface prevents workpiece material from sticking to the cutting edge.

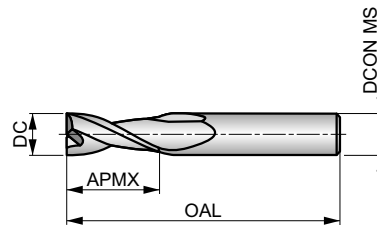

HM	W	NOF 2
	λ 30°	γ 20°
DIN 6535HA	Hi	DC h9



Workpiece material group suitability, starting values for cutting speed (m/min) and Alpha Code. Tables with feed per tooth and correction factors can be found starting from page 112.

N1.1 ■ 709 P	N1.2 ■ 533 P	N1.3 ■ 357 P	N2.1 ■ 357 O	N2.2 ■ 320 O	N2.3 ■ 229 O	N3.1 ■ 373 O	N3.2 ■ 219 O	N3.3 ■ 112 O	N4.1 ■ 373 R	N4.2 ■ 144 R
------------------------	------------------------	------------------------	------------------------	------------------------	------------------------	------------------------	------------------------	------------------------	------------------------	------------------------

DCON MS tolerance h6; RE ±0.02 mm.

Product	DC [mm]	RE [mm]	DCON MS [mm]	APMX [mm]	OAL [mm]	NOF
S6102.0	2.00	0.10	4.00	6.50	40.0	2
S6103.0XD3	3.00	0.10	3.00	9.00	40.0	2
S6103.0XD6	3.00	0.10	6.00	9.00	50.0	2
S6104.0XD4	4.00	0.10	4.00	12.00	50.0	2
S6104.0XD6	4.00	0.10	6.00	12.00	50.0	2
S6105.0	5.00	0.10	6.00	15.00	50.0	2
S6106.0	6.00	0.10	6.00	20.00	50.0	2
S6108.0	8.00	0.10	8.00	20.00	64.0	2
S61010.0	10.00	0.10	10.00	22.00	75.0	2
S61012.0	12.00	0.10	12.00	25.00	75.0	2
S61014.0	14.00	0.10	14.00	32.00	90.0	2
S61016.0	16.00	0.10	16.00	32.00	90.0	2
S61020.0	20.00	0.10	20.00	38.00	100.0	2



S611



2-Flute Solid Carbide End Mill, Extra Long Reach

Short cut length, 2-flute design with neck recess provides high rigidity for milling and profiling in hard to reach areas. The S611, with high hook geometry, is designed for high performance machining in non-ferrous materials. Polished surface prevents workpiece material from sticking to the cutting edge.

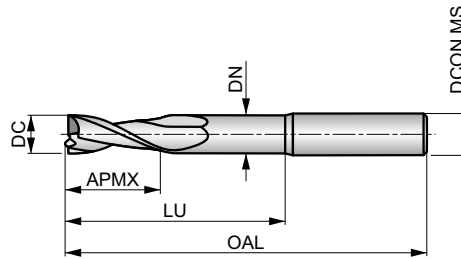

HM	W	NOF 2
	λ 30°	γ 20°
DIN 6535HA	Hi	DC h9
	DORMER	



Workpiece material group suitability, starting values for cutting speed (m/min) and Alpha Code. Tables with feed per tooth and correction factors can be found starting from page 112.

N1.1 ■ 638 P	N1.2 ■ 480 P	N1.3 ■ 321 P	N2.1 ■ 321 O	N2.2 ■ 288 O	N2.3 ■ 206 O	N3.1 ■ 336 O	N3.2 ■ 197 O	N3.3 ■ 101 O	N4.1 ■ 336 R	N4.2 ■ 130 R
------------------------	------------------------	------------------------	------------------------	------------------------	------------------------	------------------------	------------------------	------------------------	------------------------	------------------------

DCON MS tolerance h6; RE ±0.02 mm.

Product	DC [mm]	RE [mm]	DCON MS [mm]	APMX [mm]	OAL [mm]	NOF	LU [mm]	DN [mm]
S6113.0XD3	3.00	0.10	3.00	9.00	40.0	2	15.00	2.80
S6113.0XD6	3.00	0.10	6.00	9.00	50.0	2	15.00	2.80
S6114.0XD4	4.00	0.10	4.00	12.00	50.0	2	20.00	3.70
S6114.0XD6	4.00	0.10	6.00	12.00	50.0	2	20.00	3.70
S6115.0	5.00	0.10	6.00	15.00	50.0	2	20.00	4.60
S6116.0	6.00	0.10	6.00	16.00	80.0	2	40.00	5.50
S6118.0	8.00	0.10	8.00	20.00	80.0	2	40.00	7.40
S61110.0	10.00	0.10	10.00	22.00	100.0	2	60.00	9.20
S61112.0	12.00	0.10	12.00	25.00	100.0	2	60.00	11.00
S61114.0	14.00	0.10	14.00	32.00	125.0	2	75.00	13.00
S61116.0	16.00	0.10	16.00	32.00	125.0	2	75.00	15.00
S61120.0	20.00	0.10	20.00	38.00	125.0	2	75.00	19.00



S614



3-Flute Solid Carbide End Mill, Extra Long Series

Extra long cut length, 3-flute design for light profiling applications in hard to reach areas. The S614, with high hook geometry, is designed for high performance machining in non-ferrous materials.

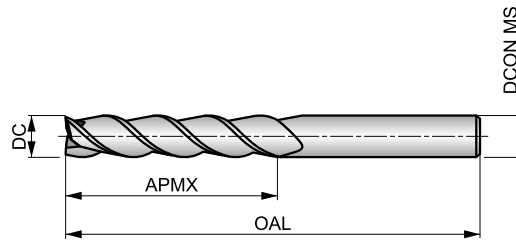

HM	W	NOF 3
	λ 40°	γ 13°
DIN 6535HA	Bright	DC h9



Workpiece material group suitability, starting values for cutting speed (m/min) and Alpha Code. Tables with feed per tooth and correction factors can be found starting from page 112.

N1.1 ■ 638 G	N1.2 ■ 480 G	N1.3 ■ 321 G	N2.1 ■ 321 F	N2.2 ■ 288 F	N2.3 ■ 206 F	N3.1 ■ 336 F	N3.2 ■ 197 F	N3.3 ■ 101 F	N4.1 ■ 336 I	N4.2 ■ 130 I
------------------------	------------------------	------------------------	------------------------	------------------------	------------------------	------------------------	------------------------	------------------------	------------------------	------------------------

DCON MS tolerance h6.

Product	DC	DCON MS	APMX	OAL	NOF
	[mm]	[mm]	[mm]	[mm]	
S6143.0XD3	3.00	3.00	19.00	60.0	3
S6143.0XD6	3.00	6.00	19.00	75.0	3
S6144.0XD4	4.00	4.00	19.00	60.0	3
S6144.0XD6	4.00	6.00	19.00	75.0	3
S6145.0	5.00	6.00	19.00	75.0	3
S6146.0	6.00	6.00	31.00	75.0	3
S6148.0	8.00	8.00	41.00	100.0	3
S61410.0	10.00	10.00	50.00	100.0	3
S61412.0	12.00	12.00	50.00	100.0	3
S61414.0	14.00	14.00	57.00	125.0	3
S61416.0	16.00	16.00	57.00	125.0	3



S629

DORMER



2-Flute Solid Carbide Ball-Nosed End Mill

Extra short cut length, 2-flute design with neck recess reduces vibrations and provides high rigidity. Ball nosed geometry is designed for high performance contouring of complex surfaces in non-ferrous materials.

HM	W	NOF 2
	λ 30°	γ 15°
DIN 6535HA	Bright	DC h9

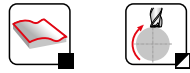
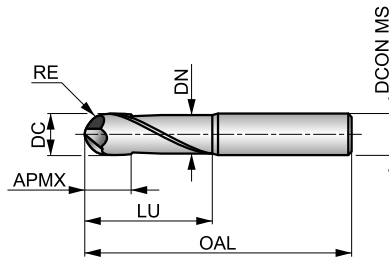

Workpiece material group suitability, starting values for cutting speed (m/min) and Alpha Code. Tables with feed per tooth and correction factors can be found starting from page 112.

N1.1	N1.2	N1.3	N2.1	N2.2	N2.3	N3.1	N3.2	N3.3	N4.1	N4.2
■ 709 N	■ 533 N	■ 357 N	■ 357 N	■ 320 N	■ 229 N	■ 373 N	■ 219 N	■ 112 N	■ 373 0	■ 144 0

DCON MS tolerance h6; RE +0/-0.02 mm.

Product	DC	RE	DCON MS	APMX	OAL	NOF	LU	DN
	[mm]	[mm]	[mm]	[mm]	[mm]		[mm]	[mm]
S6291.0 ¹⁾	1.00	0.50	4.00	0.80	50.0	2	10.00	0.90
S6291.5 ¹⁾	1.50	0.75	4.00	1.20	50.0	2	12.00	1.40
S6292.0 ¹⁾	2.00	1.00	4.00	1.60	60.0	2	18.00	1.90
S6293.0	3.00	1.50	6.00	5.00	57.0	2	20.00	2.80
S6294.0	4.00	2.00	6.00	6.00	57.0	2	20.00	3.70
S6295.0	5.00	2.50	6.00	7.00	57.0	2	20.00	4.60
S6296.0	6.00	3.00	6.00	8.00	57.0	2	20.00	5.50
S6298.0	8.00	4.00	8.00	10.00	64.0	2	25.00	7.40
S62910.0	10.00	5.00	10.00	12.00	75.0	2	35.00	9.20
S62912.0	12.00	6.00	12.00	14.00	75.0	2	35.00	11.00
S62916.0	16.00	8.00	16.00	18.00	90.0	2	45.00	15.00
S62920.0	20.00	10.00	20.00	22.00	100.0	2	50.00	19.00

¹⁾ rake angle 11°.



S638



2-Flute Solid Carbide End Mill, Extra Long Reach

Extra short cut length, 2-flute reduced shank provides clearance when machining against deep walls. The S638, with high hook geometry, is designed for high speed machining in non-ferrous materials. Polished surface prevents workpiece material from sticking to the cutting edge.

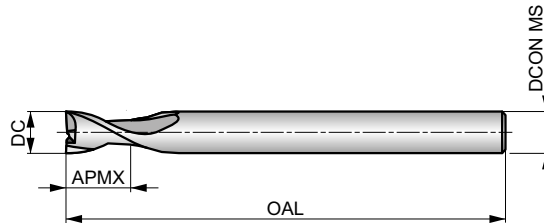

HM	W	NOF 2
	λ 30°	γ 20°
DIN 6535HA	Hi	DC h9
	DORMER	



Workpiece material group suitability, starting values for cutting speed (m/min) and Alpha Code. Tables with feed per tooth and correction factors can be found starting from page 112.

N1.1 ■ 709 N	N1.2 ■ 533 N	N1.3 ■ 357 N	N2.1 ■ 357 N	N2.2 ■ 320 N	N2.3 ■ 229 N	N3.1 ■ 373 N	N3.2 ■ 219 N	N3.3 ■ 112 N	N4.1 ■ 373 0	N4.2 ■ 144 0
------------------------	------------------------	------------------------	------------------------	------------------------	------------------------	------------------------	------------------------	------------------------	------------------------	------------------------

Reduced shank; DCON MS tolerance h6; RE ±0.02 mm.

Product	DC [mm]	RE [mm]	DCON MS [mm]	APMX [mm]	OAL [mm]	NOF
S6386.2	6.20	0.10	6.00	8.00	100.0	2
S6388.2	8.20	0.10	8.00	10.00	100.0	2
S63810.3	10.30	0.10	10.00	14.00	125.0	2
S63812.3	12.30	0.10	12.00	16.00	125.0	2
S63816.3	16.30	0.10	16.00	20.00	125.0	2
S63820.3	20.30	0.10	20.00	25.00	125.0	2



S650



3-Flute Solid Carbide End Mill

Short cut length, 3-flute with differential pitch is designed to reduce vibrations, spindle load and improve surface finish when milling. The single chip divider helps to break swarf into manageable pieces for a better evacuation in non-ferrous materials.

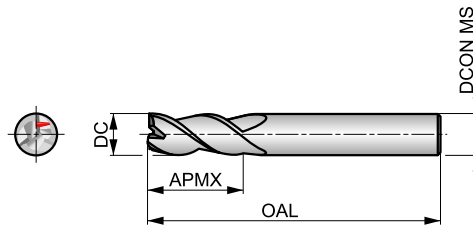

HM	W	NOF 3#
	λ 40°	γ 13°
DIN 6535HA	Bright	DC h9
	DORMER	

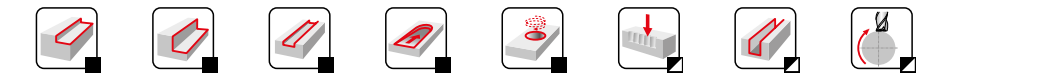

Workpiece material group suitability, starting values for cutting speed (m/min) and Alpha Code. Tables with feed per tooth and correction factors can be found starting from page 112.

N1.1 ■ 780 O	N1.2 ■ 608 O	N1.3 ■ 393 O	N2.1 ■ 393 N	N2.2 ■ 352 N	N2.3 ■ 252 N	N3.1 ■ 410 N	N3.2 ■ 241 N	N3.3 ■ 123 N	N4.1 ■ 410 P	N4.2 ■ 158 P
------------------------	------------------------	------------------------	------------------------	------------------------	------------------------	------------------------	------------------------	------------------------	------------------------	------------------------

DCON MS tolerance h6.

Product	DC [mm]	DCON MS [mm]	APMX [mm]	OAL [mm]	NOF
S6501.0	1.00	4.00	3.00	40.0	3
S6501.5	1.50	4.00	4.50	40.0	3
S6502.0	2.00	4.00	6.50	40.0	3
S6502.5	2.50	4.00	6.50	40.0	3
S6503.0XD3	3.00	3.00	9.00	40.0	3
S6503.0XD6	3.00	6.00	9.00	50.0	3
S6504.0XD4	4.00	4.00	12.00	50.0	3
S6504.0XD6	4.00	6.00	12.00	50.0	3
S6505.0	5.00	6.00	15.00	50.0	3
S6506.0	6.00	6.00	16.00	50.0	3
S6508.0	8.00	8.00	20.00	64.0	3
S65010.0	10.00	10.00	22.00	70.0	3
S65012.0	12.00	12.00	25.00	75.0	3
S65014.0	14.00	14.00	32.00	90.0	3
S65016.0	16.00	16.00	32.00	90.0	3
S65020.0 ¹⁾	20.00	20.00	38.00	100.0	3

¹⁾ No differential pitch and chip divider.



S654



3-Flute Solid Carbide Roughing End Mill, Long Reach

Short cut length, 3-flute roughing design with neck recess and differential pitch to reduce vibrations and maximize productivity and tool life. The S654, with NRA profile, breaks the swarf into small manageable pieces. It is designed for high performance roughing in non-ferrous materials.

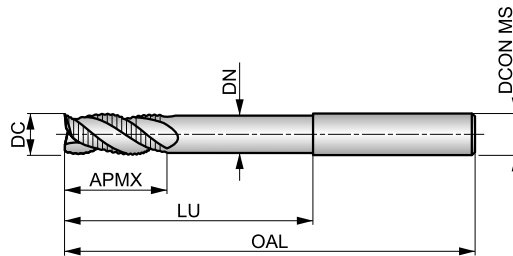

HM	W NRA	NOF 3#
	λ 40°	γ 15°
DIN 6535HA	Bright	DC h9
	DORMER	



Workpiece material group suitability, starting values for cutting speed (m/min) and Alpha Code. Tables with feed per tooth and correction factors can be found starting from page 112.

N1.1 ■ 709 O	N1.2 ■ 533 O	N1.3 ■ 357 O	N2.1 ■ 357 N	N2.2 ■ 320 N	N2.3 ■ 229 N	N3.1 ■ 373 N	N3.2 ■ 219 N	N3.3 ■ 112 N	N4.1 ■ 373 P	N4.2 ■ 144 P
------------------------	------------------------	------------------------	------------------------	------------------------	------------------------	------------------------	------------------------	------------------------	------------------------	------------------------

DCON MS tolerance h6; RE ±0.02 mm.

Product	DC [mm]	RE [mm]	DCON MS [mm]	APMX [mm]	OAL [mm]	NOF	LU [mm]	DN [mm]
S6546.0	6.00	0.10	6.00	13.00	75.0	3	40.00	5.50
S6548.0	8.00	0.10	8.00	20.00	75.0	3	40.00	7.40
S65410.0	10.00	0.10	10.00	22.00	100.0	3	60.00	9.20
S65412.0	12.00	0.12	12.00	26.00	100.0	3	60.00	11.00
S65416.0	16.00	0.16	16.00	32.00	125.0	3	75.00	15.00
S65420.0	20.00	0.20	20.00	40.00	150.0	3	100.00	19.00



S662



4-Flute Solid Carbide Corner Radius End Mill

Short cut length, 4-flute design with differential pitch and different corner radius available, for profile milling where a corner radius is required. The S662, with high hook geometry, is designed for high performance machining in non-ferrous materials.

HM	W	NOF 4 \neq
	λ 40°	γ 10°
DIN 6535HA	Bright	DC h9
	DORMER	

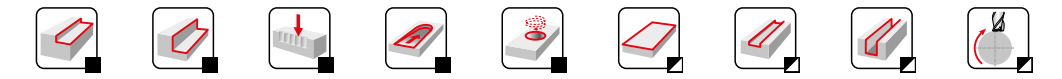
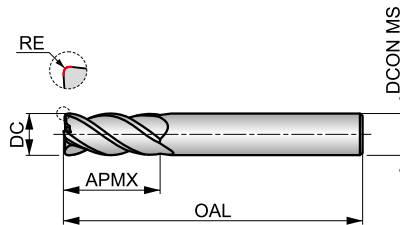

Workpiece material group suitability, starting values for cutting speed (m/min) and Alpha Code. Tables with feed per tooth and correction factors can be found starting from page 112.

N1.1 ■ 709 0	N1.2 ■ 533 0	N1.3 ■ 357 0	N2.1 ■ 357 N	N2.2 ■ 320 N	N2.3 ■ 229 N	N3.1 ■ 373 N	N3.2 ■ 219 N	N3.3 ■ 112 N	N4.1 ■ 373 P	N4.2 ■ 144 P
------------------------	------------------------	------------------------	------------------------	------------------------	------------------------	------------------------	------------------------	------------------------	------------------------	------------------------

DCON MS tolerance h6; RE \pm 0.01 mm.

Product	DC [mm]	RE [mm]	DCON MS [mm]	APMX [mm]	OAL [mm]	NOF
S6623.0XR0.3	3.00	0.30	6.00	9.00	57.0	4
S6624.0XR0.3	4.00	0.30	6.00	12.00	57.0	4
S6624.0XR0.5	4.00	0.50	6.00	12.00	57.0	4
S6625.0XR0.3	5.00	0.30	6.00	15.00	57.0	4
S6625.0XR0.5	5.00	0.50	6.00	15.00	57.0	4
S6626.0XR0.5	6.00	0.50	6.00	16.00	57.0	4
S6626.0XR1.0	6.00	1.00	6.00	16.00	57.0	4
S6626.0XR2.0	6.00	2.00	6.00	16.00	57.0	4
S6628.0XR0.5	8.00	0.50	8.00	20.00	64.0	4
S6628.0XR1.0	8.00	1.00	8.00	20.00	64.0	4
S6628.0XR2.0	8.00	2.00	8.00	20.00	64.0	4
S66210.0XR0.5	10.00	0.50	10.00	22.00	72.0	4
S66210.0XR1.0	10.00	1.00	10.00	22.00	72.0	4
S66210.0XR2.0	10.00	2.00	10.00	22.00	72.0	4
S66212.0XR1.0	12.00	1.00	12.00	26.00	83.0	4
S66212.0XR2.0	12.00	2.00	12.00	26.00	83.0	4
S66212.0XR2.5	12.00	2.50	12.00	26.00	83.0	4
S66212.0XR3.0	12.00	3.00	12.00	26.00	83.0	4
S66216.0XR1.0	16.00	1.00	16.00	32.00	92.0	4
S66216.0XR2.0	16.00	2.00	16.00	32.00	92.0	4
S66216.0XR3.0	16.00	3.00	16.00	32.00	92.0	4
S66216.0XR4.0	16.00	4.00	16.00	32.00	92.0	4
S66220.0XR2.0	20.00	2.00	20.00	38.00	104.0	4
S66220.0XR4.0	20.00	4.00	20.00	38.00	104.0	4



S612



4-Flute Solid Carbide End Mill

Short cut length, 4-flute design provides high rigidity for standard profile milling. Diamond like coating increases service life and improves performance. For milling abrasive materials.

HM	N	NOF 4
	λ 40°	γ 10°
DIN 6535HA	Diamond	DC h9
	DORMER	

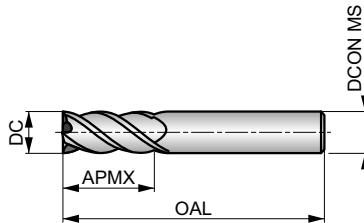

Workpiece material group suitability, starting values for cutting speed (m/min) and Alpha Code. Tables with feed per tooth and correction factors can be found starting from page 112.

N5.1

■ 350 G

DCON MS tolerance h6.

Product	DC [mm]	DCON MS [mm]	APMX [mm]	OAL [mm]	NOF
S6121.0	1.00	3.00	3.00	50.0	4
S6121.5	1.50	3.00	4.50	50.0	4
S6122.0	2.00	3.00	6.50	50.0	4
S6122.5	2.50	3.00	6.50	50.0	4
S6123.0	3.00	3.00	9.00	50.0	4
S6124.0	4.00	4.00	12.00	50.0	4
S6125.0	5.00	5.00	15.00	50.0	4
S6126.0	6.00	6.00	20.00	60.0	4
S6128.0	8.00	8.00	20.00	64.0	4
S61210.0	10.00	10.00	22.00	70.0	4
S61212.0	12.00	12.00	25.00	75.0	4



S802HA



2-Flute Solid Carbide Slot End Mill, DIN 6535 HA Shank

Extra short cut length, 2-flute design provides high rigidity for milling shallow slots to a P9 tolerance and ramping operation. AlCrN coating improves performance and extends the tool life.

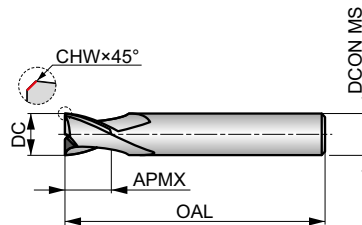

HM	N	NOF 2
	λ 28°	γ 9°
	AlCrN	
DIN 6527K		



Workpiece material group suitability, starting values for cutting speed (m/min) and Alpha Code. Tables with feed per tooth and correction factors can be found starting from page 112.

P1.1 ■ 206 K	P1.2 ■ 230 K	P1.3 ■ 238 K	P2.1 ■ 176 K	P2.2 ■ 155 K	P2.3 ■ 137 J	P3.1 ■ 143 K	P3.2 ■ 114 J	P3.3 ■ 97 J	P4.1 ■ 84 J	P4.2 ■ 72 J	P4.3 ■ 58 J	M1.1 ■ 121 K	M1.2 ■ 102 K
M2.1 ■ 107 K	M2.2 ■ 89 J	M2.3 ▣ 75 J	M3.1 ■ 99 J	M3.2 ■ 85 J	M3.3 ▣ 76 J	M4.1 ▣ 75 J	M4.2 ▣ 63 J	K1.1 ■ 205 K	K1.2 ■ 152 K	K1.3 ■ 114 K	K2.1 ■ 210 K	K2.2 ■ 171 K	K2.3 ■ 137 J
K3.1 ■ 186 K	K3.2 ■ 143 K	K3.3 ■ 115 J	K4.1 ■ 173 J	K4.2 ■ 131 J	K4.3 ■ 95 J	K4.4 ■ 82 J	K4.5 ■ 68 J	K5.1 ■ 196 J	K5.2 ■ 147 J	K5.3 ■ 114 J	N1.1 ▣ 408 K	N1.2 ▣ 307 K	N1.3 ■ 206 K
N2.1 ■ 206 K	N2.2 ■ 184 K	N2.3 ■ 132 K	N3.1 ■ 215 K	N3.2 ■ 125 K	N3.3 ▣ 64 K	N4.1 ▣ 215 K	N4.2 ▣ 83 K	S1.1 ▣ 81 J	S1.2 ▣ 71 J	S2.1 ▣ 55 J	S3.1 ▣ 41 J	S4.1 ▣ 32 J	

DCON MS tolerance h6; DC ≤ 7.75 mm: CHW ± 0.03X45° mm; DC > 7.75 mm: CHW ± 0.05X45° mm.

Product	DC [mm]	CHW [mm]	DCON MS [mm]	APMX [mm]	OAL [mm]	NOF
S802HA1.0	1.00	–	3.00	3.00	38.0	2
S802HA1.5	1.50	–	3.00	3.00	38.0	2
S802HA2.0	2.00	–	6.00	3.00	50.0	2
S802HA2.5	2.50	0.08	6.00	3.00	50.0	2
S802HA3.0	3.00	0.08	6.00	4.00	50.0	2
S802HA3.5	3.50	0.08	6.00	4.00	50.0	2
S802HA4.0	4.00	0.13	6.00	5.00	54.0	2
S802HA4.5	4.50	0.13	6.00	5.00	54.0	2
S802HA5.0	5.00	0.13	6.00	6.00	54.0	2
S802HA6.0	6.00	0.13	6.00	7.00	54.0	2
S802HA7.0	7.00	0.13	8.00	8.00	58.0	2
S802HA8.0	8.00	0.20	8.00	9.00	58.0	2
S802HA9.0	9.00	0.20	10.00	10.00	66.0	2
S802HA10.0	10.00	0.20	10.00	11.00	66.0	2
S802HA12.0	12.00	0.20	12.00	12.00	73.0	2
S802HA14.0	14.00	0.20	14.00	14.00	75.0	2
S802HA16.0	16.00	0.20	16.00	16.00	82.0	2
S802HA18.0	18.00	0.20	18.00	18.00	84.0	2
S802HA20.0	20.00	0.30	20.00	20.00	92.0	2



S802HB



2-Flute Solid Carbide Slot End Mill, DIN 6535 HB Shank

Extra short cut length, 2-flute design provides high rigidity for milling shallow slots to a P9 tolerance and ramping operation. The Weldon shank prevents the end mill from slipping in the toolholder. AlCrN coating improves performance and extends the tool life.

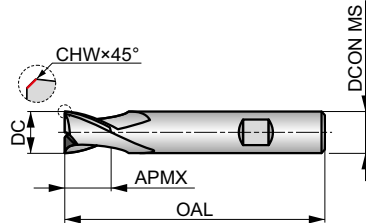

HM	N	NOF 2
	λ 28°	γ 9°
DIN 6535HB	AlCrN	
DIN 6527K		



Workpiece material group suitability, starting values for cutting speed (m/min) and Alpha Code. Tables with feed per tooth and correction factors can be found starting from page 112.

P1.1 ■ 206 K	P1.2 ■ 230 K	P1.3 ■ 238 K	P2.1 ■ 176 K	P2.2 ■ 155 K	P2.3 ■ 137 J	P3.1 ■ 143 K	P3.2 ■ 114 J	P3.3 ■ 97 J	P4.1 ■ 84 J	P4.2 ■ 72 J	P4.3 ■ 58 J	M1.1 ■ 121 K	M1.2 ■ 102 K
M2.1 ■ 107 K	M2.2 ■ 89 J	M2.3 ▣ 75 J	M3.1 ■ 99 J	M3.2 ■ 85 J	M3.3 ▣ 76 J	M4.1 ▣ 75 J	M4.2 ▣ 63 J	K1.1 ■ 205 K	K1.2 ■ 152 K	K1.3 ■ 114 K	K2.1 ■ 210 K	K2.2 ■ 171 K	K2.3 ■ 137 J
K3.1 ■ 186 K	K3.2 ■ 143 K	K3.3 ■ 115 J	K4.1 ■ 173 J	K4.2 ■ 131 J	K4.3 ■ 95 J	K4.4 ■ 82 J	K4.5 ■ 68 J	K5.1 ■ 196 J	K5.2 ■ 147 J	K5.3 ■ 114 J	N1.1 ▣ 408 K	N1.2 ▣ 307 K	N1.3 ■ 206 K
N2.1 ■ 206 K	N2.2 ■ 184 K	N2.3 ■ 132 K	N3.1 ■ 215 K	N3.2 ■ 125 K	N3.3 ▣ 64 K	N4.1 ▣ 215 K	N4.2 ▣ 83 K	S1.1 ▣ 81 J	S1.2 ▣ 71 J	S2.1 ▣ 55 J	S3.1 ▣ 41 J	S4.1 ▣ 32 J	

DCON MS tolerance h6; DC≤7.75 mm: CHW ± 0.03X45° mm; DC>7.75 mm: CHW ± 0.05X45° mm.

Product	DC [mm]	CHW [mm]	DCON MS [mm]	APMX [mm]	OAL [mm]	NOF
S802HB2.0	2.00	—	6.00	3.00	50.0	2
S802HB2.5	2.50	0.08	6.00	3.00	50.0	2
S802HB3.0	3.00	0.08	6.00	4.00	50.0	2
S802HB3.5	3.50	0.08	6.00	4.00	50.0	2
S802HB4.0	4.00	0.13	6.00	5.00	54.0	2
S802HB4.5	4.50	0.13	6.00	5.00	54.0	2
S802HB5.0	5.00	0.13	6.00	6.00	54.0	2
S802HB6.0	6.00	0.13	6.00	7.00	54.0	2
S802HB7.0	7.00	0.13	8.00	8.00	58.0	2
S802HB8.0	8.00	0.20	8.00	9.00	58.0	2
S802HB9.0	9.00	0.20	10.00	10.00	66.0	2
S802HB10.0	10.00	0.20	10.00	11.00	66.0	2
S802HB12.0	12.00	0.20	12.00	12.00	73.0	2
S802HB14.0	14.00	0.20	14.00	14.00	75.0	2
S802HB16.0	16.00	0.20	16.00	16.00	82.0	2
S802HB18.0	18.00	0.20	18.00	18.00	84.0	2
S802HB20.0	20.00	0.30	20.00	20.00	92.0	2



S812HA



2-Flute Solid Carbide Slot End Mill, DIN 6535 HA Shank

Short cut length, 2-flute design provides high rigidity for milling standard slots to a P9 tolerance and ramping operation. AlCrN coating improves performance and extends the tool life.

HM	N	NOF 2
	λ 28°	γ 9°
DIN 6535HA	AlCrN	
DIN 6527L		

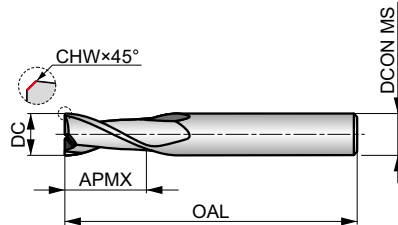

Workpiece material group suitability, starting values for cutting speed (m/min) and Alpha Code. Tables with feed per tooth and correction factors can be found starting from page 112.

P1.1 ■ 166 K	P1.2 ■ 186 K	P1.3 ■ 192 K	P2.1 ■ 142 K	P2.2 ■ 125 K	P2.3 ■ 111 J	P3.1 ■ 115 K	P3.2 ■ 93 J	P3.3 ■ 78 J	P4.1 ■ 68 J	P4.2 ■ 59 J	P4.3 ■ 47 J	M1.1 ■ 97 K	M1.2 ■ 81 K
M2.1 ■ 85 K	M2.2 ■ 71 J	M3.1 ■ 79 J	M3.2 ■ 68 J	M3.3 ■ 61 J	M4.1 ■ 60 J	K1.1 ■ 166 K	K1.2 ■ 123 K	K1.3 ■ 92 K	K2.1 ■ 170 K	K2.2 ■ 138 K	K2.3 ■ 110 J	K3.1 ■ 150 K	K3.2 ■ 115 K
K3.3 ■ 93 J	K4.1 ■ 140 J	K4.2 ■ 105 J	K4.3 ■ 77 J	K4.4 ■ 66 J	K4.5 ■ 56 J	K5.1 ■ 159 J	K5.2 ■ 118 J	K5.3 ■ 92 J	N1.1 ■ 330 K	N1.2 ■ 247 K	N1.3 ■ 166 K	N2.1 ■ 166 K	N2.2 ■ 148 K
N2.3 ■ 107 K	N3.1 ■ 173 K	N3.2 ■ 101 K	N3.3 ■ 52 K	N4.1 ■ 173 K	N4.2 ■ 67 K	S1.1 ■ 72 J	S1.2 ■ 64 J	S2.1 ■ 49 J	S3.1 ■ 38 J	S4.1 ■ 30 J			

DCON MS tolerance h6; DC ≤ 7.00 mm: CHW ± 0.03X45° mm; DC > 7.00 mm: CHW ± 0.05X45° mm.

Product	DC [mm]	CHW [mm]	DCON MS [mm]	APMX [mm]	OAL [mm]	NOF
S812HA2.0	2.00	—	6.00	6.00	57.0	2
S812HA2.5	2.50	0.08	6.00	7.00	57.0	2
S812HA3.0	3.00	0.08	6.00	7.00	57.0	2
S812HA3.5	3.50	0.08	6.00	7.00	57.0	2
S812HA4.0	4.00	0.13	6.00	8.00	57.0	2
S812HA4.5	4.50	0.13	6.00	8.00	57.0	2
S812HA5.0	5.00	0.13	6.00	10.00	57.0	2
S812HA6.0	6.00	0.13	6.00	10.00	57.0	2
S812HA7.0	7.00	0.13	8.00	13.00	63.0	2
S812HA8.0	8.00	0.20	8.00	16.00	63.0	2
S812HA9.0	9.00	0.20	10.00	16.00	72.0	2
S812HA10.0	10.00	0.20	10.00	19.00	72.0	2
S812HA12.0	12.00	0.20	12.00	22.00	83.0	2
S812HA14.0	14.00	0.20	14.00	22.00	83.0	2
S812HA16.0	16.00	0.20	16.00	26.00	92.0	2
S812HA18.0	18.00	0.20	18.00	26.00	92.0	2
S812HA20.0	20.00	0.30	20.00	32.00	104.0	2



S812HB



2-Flute Solid Carbide Slot End Mill, DIN 6535 HB Shank

Short cut length, 2-flute design provides high rigidity for milling standard slots to a P9 tolerance and ramping operation. The Weldon shank prevents the end mill from slipping in the toolholder. AlCrN coating improves performance and extends the tool life.

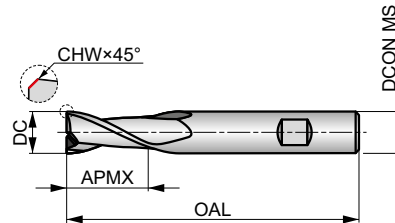

HM	N	NOF 2
	λ 28°	γ 9°
DIN 6535HB	AlCrN	
DIN 6527L		



Workpiece material group suitability, starting values for cutting speed (m/min) and Alpha Code. Tables with feed per tooth and correction factors can be found starting from page 112.

P1.1 ■ 166 K	P1.2 ■ 186 K	P1.3 ■ 192 K	P2.1 ■ 142 K	P2.2 ■ 125 K	P2.3 ■ 111 J	P3.1 ■ 115 K	P3.2 ■ 93 J	P3.3 ■ 78 J	P4.1 ■ 68 J	P4.2 ■ 59 J	P4.3 ■ 47 J	M1.1 ■ 97 K	M1.2 ■ 81 K
M2.1 ■ 85 K	M2.2 ■ 71 J	M3.1 ■ 79 J	M3.2 ■ 68 J	M3.3 ■ 61 J	M4.1 ■ 60 J	K1.1 ■ 166 K	K1.2 ■ 123 K	K1.3 ■ 92 K	K2.1 ■ 170 K	K2.2 ■ 138 K	K2.3 ■ 110 J	K3.1 ■ 150 K	K3.2 ■ 115 K
K3.3 ■ 93 J	K4.1 ■ 140 J	K4.2 ■ 105 J	K4.3 ■ 77 J	K4.4 ■ 66 J	K4.5 ■ 56 J	K5.1 ■ 159 J	K5.2 ■ 118 J	K5.3 ■ 92 J	N1.1 ■ 330 K	N1.2 ■ 247 K	N1.3 ■ 166 K	N2.1 ■ 166 K	N2.2 ■ 148 K
N2.3 ■ 107 K	N3.1 ■ 173 K	N3.2 ■ 101 K	N3.3 ■ 52 K	N4.1 ■ 173 K	N4.2 ■ 67 K	S1.1 ■ 72 J	S1.2 ■ 64 J	S2.1 ■ 49 J	S3.1 ■ 38 J	S4.1 ■ 30 J			

DCON MS tolerance h6; DC≤7.00 mm: CHW ± 0.03X45° mm; DC>7.00 mm: CHW ± 0.05X45° mm.

Product	DC [mm]	CHW [mm]	DCON MS [mm]	APMX [mm]	OAL [mm]	NOF
S812HB2.0	2.00	0.00	6.00	6.00	57.0	2
S812HB2.5	2.50	0.08	6.00	7.00	57.0	2
S812HB3.0	3.00	0.08	6.00	7.00	57.0	2
S812HB3.5	3.50	0.08	6.00	7.00	57.0	2
S812HB4.0	4.00	0.13	6.00	8.00	57.0	2
S812HB4.5	4.50	0.13	6.00	8.00	57.0	2
S812HB5.0	5.00	0.13	6.00	10.00	57.0	2
S812HB6.0	6.00	0.13	6.00	10.00	57.0	2
S812HB7.0	7.00	0.13	8.00	13.00	63.0	2
S812HB8.0	8.00	0.20	8.00	16.00	63.0	2
S812HB9.0	9.00	0.20	10.00	16.00	72.0	2
S812HB10.0	10.00	0.20	10.00	19.00	72.0	2
S812HB12.0	12.00	0.20	12.00	22.00	83.0	2
S812HB14.0	14.00	0.20	14.00	22.00	83.0	2
S812HB16.0	16.00	0.20	16.00	26.00	92.0	2
S812HB18.0	18.00	0.20	18.00	26.00	92.0	2
S812HB20.0	20.00	0.30	20.00	32.00	104.0	2



S822



2-Flute Solid Carbide Slot End Mill

Medium cut length, 2-flute design provides high rigidity for milling standard slots to a P9 tolerance and ramping operation. AlCrN coating improves performance and extends the tool life.

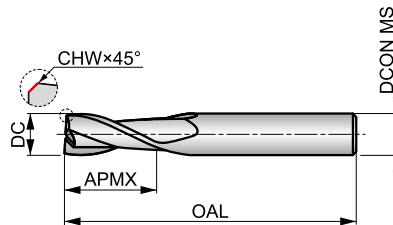

HM	N	NOF 2
	λ 28°	γ 9°
DIN 6535HA	AlCrN	
DORMER		



Workpiece material group suitability, starting values for cutting speed (m/min) and Alpha Code. Tables with feed per tooth and correction factors can be found starting from page 112.

P1.1 ■ 146 K	P1.2 ■ 164 K	P1.3 ■ 169 K	P2.1 ■ 125 K	P2.2 ■ 110 K	P2.3 ■ 98 J	P3.1 ■ 101 K	P3.2 ■ 82 J	P3.3 ■ 69 J	P4.1 ■ 61 J	P4.2 ■ 52 J	P4.3 ■ 41 J	M1.1 ■ 85 K	M1.2 ■ 72 K
M2.1 ■ 76 K	M2.2 ■ 62 J	M3.1 ■ 70 J	M3.2 ■ 60 J	M3.3 ■ 54 J	M4.1 ■ 53 J	K1.1 ■ 145 K	K1.2 ■ 108 K	K1.3 ■ 81 K	K2.1 ■ 150 K	K2.2 ■ 122 K	K2.3 ■ 97 J	K3.1 ■ 133 K	K3.2 ■ 102 K
K3.3 ■ 82 J	K4.1 ■ 123 J	K4.2 ■ 93 J	K4.3 ■ 68 J	K4.4 ■ 59 J	K4.5 ■ 48 J	K5.1 ■ 139 J	K5.2 ■ 105 J	K5.3 ■ 81 J	N1.1 ■ 287 K	N1.2 ■ 216 K	N1.3 ■ 144 K	N2.1 ■ 144 K	N2.2 ■ 129 K
N2.3 ■ 93 K	N3.1 ■ 152 K	N3.2 ■ 88 K	N3.3 ■ 45 K	N4.1 ■ 152 K	N4.2 ■ 59 K	S1.1 ■ 58 J	S1.2 ■ 51 J	S2.1 ■ 39 J	S3.1 ■ 29 J	S4.1 ■ 23 J			

DCON MS tolerance h6; DC ≤ 7.00 mm: CHW ± 0.03X45° mm; DC > 7.00 mm: CHW ± 0.05X45° mm.

Product	DC [mm]	CHW [mm]	DCON MS [mm]	APMX [mm]	OAL [mm]	NOF
S8222.0	2.00	—	6.00	8.00	57.0	2
S8222.5	2.50	0.08	6.00	12.00	57.0	2
S8223.0	3.00	0.08	6.00	12.00	57.0	2
S8224.0	4.00	0.13	6.00	14.00	57.0	2
S8225.0	5.00	0.13	6.00	16.00	57.0	2
S8226.0	6.00	0.13	6.00	19.00	57.0	2
S8227.0	7.00	0.13	8.00	19.00	63.0	2
S8228.0	8.00	0.20	8.00	19.00	63.0	2
S8229.0	9.00	0.20	10.00	21.00	72.0	2
S82210.0	10.00	0.20	10.00	22.00	72.0	2
S82212.0	12.00	0.20	12.00	25.00	83.0	2
S82214.0	14.00	0.20	14.00	30.00	83.0	2
S82216.0	16.00	0.20	16.00	32.00	92.0	2
S82218.0	18.00	0.20	18.00	32.00	92.0	2
S82220.0	20.00	0.30	20.00	38.00	104.0	2



S803HA



3-Flute Solid Carbide Slot End Mill, DIN 6535 HA Shank

Extra short cut length, 3-flute design provides high rigidity for milling shallow slots to a P9 tolerance. AlCrN coating increases service life and improves performance. Also suited for plunging and ramping milling.

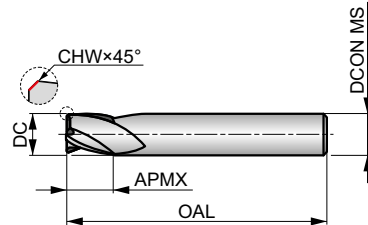

HM	N	NOF 3
	λ 28°	γ 9°
DIN 6535HA	AlCrN	
DIN 6527K		



Workpiece material group suitability, starting values for cutting speed (m/min) and Alpha Code. Tables with feed per tooth and correction factors can be found starting from page 112.

P1.1 ■ 206 J	P1.2 ■ 230 J	P1.3 ■ 238 J	P2.1 ■ 176 J	P2.2 ■ 155 J	P2.3 ■ 137 I	P3.1 ■ 143 J	P3.2 ■ 114 I	P3.3 ■ 97 I	P4.1 ■ 84 I	P4.2 ■ 72 I	P4.3 ■ 58 I	M1.1 ■ 121 J	M1.2 ■ 102 J
M2.1 ■ 107 J	M2.2 ■ 89 I	M2.3 ▣ 75 I	M3.1 ■ 99 I	M3.2 ■ 85 I	M3.3 ▣ 76 I	M4.1 ▣ 75 I	M4.2 ▣ 63 I	K1.1 ■ 205 J	K1.2 ■ 152 J	K1.3 ■ 114 J	K2.1 ■ 210 J	K2.2 ■ 171 J	K2.3 ■ 137 I
K3.1 ■ 186 J	K3.2 ■ 143 J	K3.3 ■ 115 I	K4.1 ■ 173 I	K4.2 ■ 131 I	K4.3 ■ 95 I	K4.4 ■ 82 I	K4.5 ■ 68 I	K5.1 ■ 196 I	K5.2 ■ 147 I	K5.3 ■ 114 I	N1.1 ▣ 408 K	N1.2 ▣ 307 K	N1.3 ■ 206 K
N2.1 ■ 206 J	N2.2 ■ 184 J	N2.3 ■ 132 J	N3.1 ■ 215 J	N3.2 ■ 125 J	N3.3 ▣ 64 J	N4.1 ▣ 215 J	N4.2 ▣ 83 J	S1.1 ▣ 81 I	S1.2 ▣ 71 I	S2.1 ▣ 55 I	S3.1 ▣ 41 I	S4.1 ▣ 32 I	

DCON MS tolerance h6; DC≤7.75 mm: CHW ± 0.03X45° mm; DC>7.75 mm: CHW ± 0.05X45° mm.

Product	DC [mm]	CHW [mm]	DCON MS [mm]	APMX [mm]	OAL [mm]	NOF
S803HA1.0	1.00	—	3.00	3.00	38.0	3
S803HA1.5	1.50	—	3.00	3.00	38.0	3
S803HA2.0	2.00	—	6.00	3.00	50.0	3
S803HA2.5	2.50	0.08	6.00	3.00	50.0	3
S803HA2.8	2.80	0.08	6.00	4.00	50.0	3
S803HA3.0	3.00	0.08	6.00	4.00	50.0	3
S803HA3.5	3.50	0.08	6.00	4.00	50.0	3
S803HA3.8	3.80	0.08	6.00	5.00	54.0	3
S803HA4.0	4.00	0.13	6.00	5.00	54.0	3
S803HA4.5	4.50	0.13	6.00	5.00	54.0	3
S803HA4.8	4.80	0.13	6.00	6.00	54.0	3
S803HA5.0	5.00	0.13	6.00	6.00	54.0	3
S803HA6.0	6.00	0.13	6.00	7.00	54.0	3
S803HA7.0	7.00	0.13	8.00	8.00	58.0	3
S803HA8.0	8.00	0.20	8.00	9.00	58.0	3
S803HA9.0	9.00	0.20	10.00	10.00	66.0	3
S803HA10.0	10.00	0.20	10.00	11.00	66.0	3
S803HA12.0	12.00	0.20	12.00	12.00	73.0	3
S803HA14.0	14.00	0.20	14.00	14.00	75.0	3
S803HA16.0	16.00	0.20	16.00	16.00	82.0	3
S803HA18.0	18.00	0.20	18.00	18.00	84.0	3
S803HA20.0	20.00	0.30	20.00	20.00	92.0	3



S803HB



3-Flute Solid Carbide Slot End Mill, DIN 6535 HB Shank

Extra short cut length, 3-flute design provides high rigidity for milling shallow slots to a P9 tolerance. AlCrN coating increases service life and improves performance. Also suited for plunging and ramping milling.

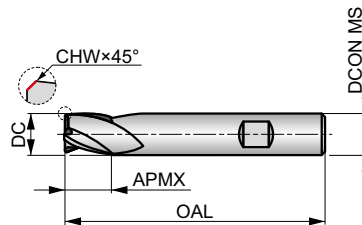

HM	N	NOF 3
	λ 28°	γ 9°
	AlCrN	
DIN 6527K		



Workpiece material group suitability, starting values for cutting speed (m/min) and Alpha Code. Tables with feed per tooth and correction factors can be found starting from page 112.

P1.1 ■ 206 J	P1.2 ■ 230 J	P1.3 ■ 238 J	P2.1 ■ 176 J	P2.2 ■ 155 J	P2.3 ■ 137 I	P3.1 ■ 143 J	P3.2 ■ 114 I	P3.3 ■ 97 I	P4.1 ■ 84 I	P4.2 ■ 72 I	P4.3 ■ 58 I	M1.1 ■ 121 J	M1.2 ■ 102 J
M2.1 ■ 107 J	M2.2 ■ 89 I	M2.3 ▣ 75 I	M3.1 ■ 99 I	M3.2 ■ 85 I	M3.3 ▣ 76 I	M4.1 ▣ 75 I	M4.2 ▣ 63 I	K1.1 ■ 205 J	K1.2 ■ 152 J	K1.3 ■ 114 J	K2.1 ■ 210 J	K2.2 ■ 171 J	K2.3 ■ 137 I
K3.1 ■ 186 J	K3.2 ■ 143 J	K3.3 ■ 115 I	K4.1 ■ 173 I	K4.2 ■ 131 I	K4.3 ■ 95 I	K4.4 ■ 82 I	K4.5 ■ 68 I	K5.1 ■ 196 I	K5.2 ■ 147 I	K5.3 ■ 114 I	N1.1 ▣ 408 K	N1.2 ▣ 307 K	N1.3 ■ 206 K
N2.1 ■ 206 J	N2.2 ■ 184 J	N2.3 ■ 132 J	N3.1 ■ 215 J	N3.2 ■ 125 J	N3.3 ▣ 64 J	N4.1 ▣ 215 J	N4.2 ▣ 83 J	S1.1 ▣ 81 I	S1.2 ▣ 71 I	S2.1 ▣ 55 I	S3.1 ▣ 41 I	S4.1 ▣ 32 I	

DCON MS tolerance h6; DC ≤ 7.75 mm: CHW ± 0.03X45° mm; DC > 7.75 mm: CHW ± 0.05X45° mm.

Product	DC [mm]	CHW [mm]	DCON MS [mm]	APMX [mm]	OAL [mm]	NOF
S803HB2.0	2.00	–	6.00	3.00	50.0	3
S803HB2.5	2.50	0.08	6.00	3.00	50.0	3
S803HB2.8	2.80	0.08	6.00	4.00	50.0	3
S803HB3.0	3.00	0.08	6.00	4.00	50.0	3
S803HB3.5	3.50	0.08	6.00	4.00	50.0	3
S803HB3.8	3.80	0.08	6.00	5.00	54.0	3
S803HB4.0	4.00	0.13	6.00	5.00	54.0	3
S803HB4.5	4.50	0.13	6.00	5.00	54.0	3
S803HB4.8	4.80	0.13	6.00	6.00	54.0	3
S803HB5.0	5.00	0.13	6.00	6.00	54.0	3
S803HB5.75	5.75	0.13	6.00	7.00	54.0	3
S803HB6.0	6.00	0.13	6.00	7.00	54.0	3
S803HB6.75	6.75	0.13	8.00	8.00	58.0	3
S803HB7.0	7.00	0.13	8.00	8.00	58.0	3
S803HB7.75	7.75	0.13	8.00	9.00	58.0	3
S803HB8.0	8.00	0.20	8.00	9.00	58.0	3
S803HB9.0	9.00	0.20	10.00	10.00	66.0	3
S803HB9.7	9.70	0.20	10.00	11.00	66.0	3
S803HB10.0	10.00	0.20	10.00	11.00	66.0	3
S803HB11.7	11.70	0.20	12.00	12.00	73.0	3
S803HB12.0	12.00	0.20	12.00	12.00	73.0	3
S803HB14.0	14.00	0.20	14.00	14.00	75.0	3
S803HB16.0	16.00	0.20	16.00	16.00	82.0	3
S803HB18.0	18.00	0.20	18.00	18.00	84.0	3
S803HB20.0	20.00	0.30	20.00	20.00	92.0	3



S813HA



3-Flute Solid Carbide Slot End Mill, DIN 6535 HA Shank

Short cut length, 3-flute design provides high rigidity for milling standard slots to a P9 tolerance. AlCrN coating increases service life and improves performance. Also suited for plunging and ramping milling.

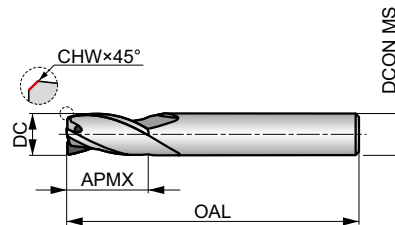

HM	N	NOF 3
	λ 28°	γ 9°
DIN 6535HA	AlCrN	
DIN 6527L		



Workpiece material group suitability, starting values for cutting speed (m/min) and Alpha Code. Tables with feed per tooth and correction factors can be found starting from page 112.

P1.1 ■ 166 J	P1.2 ■ 186 J	P1.3 ■ 192 J	P2.1 ■ 142 J	P2.2 ■ 125 J	P2.3 ■ 111 I	P3.1 ■ 115 J	P3.2 ■ 93 I	P3.3 ■ 78 I	P4.1 ■ 68 I	P4.2 ■ 59 I	P4.3 ▣ 47 I	M1.1 ■ 97 J	M1.2 ■ 81 J
M2.1 ■ 85 J	M2.2 ■ 71 I	M3.1 ▣ 79 I	M3.2 ▣ 68 I	M3.3 ▣ 61 I	M4.1 ▣ 60 I	K1.1 ■ 166 J	K1.2 ■ 123 J	K1.3 ■ 92 J	K2.1 ■ 170 J	K2.2 ■ 138 J	K2.3 ■ 110 I	K3.1 ■ 150 J	K3.2 ■ 115 J
K3.3 ■ 93 I	K4.1 ■ 140 I	K4.2 ■ 105 I	K4.3 ■ 77 I	K4.4 ■ 66 I	K4.5 ■ 56 I	K5.1 ■ 159 I	K5.2 ■ 118 I	K5.3 ■ 92 I	N1.1 ▣ 330 K	N1.2 ▣ 247 K	N1.3 ■ 166 K	N2.1 ■ 166 J	N2.2 ■ 148 J
N2.3 ■ 107 J	N3.1 ■ 173 J	N3.2 ■ 101 J	N3.3 ▣ 52 J	N4.1 ▣ 173 J	N4.2 ▣ 67 J	S1.1 ▣ 172 I	S1.2 ▣ 64 I	S2.1 ▣ 49 I	S3.1 ▣ 38 I	S4.1 ▣ 30 I			

DCON MS tolerance h6; DC≤7.00 mm: CHW ± 0.03X45° mm; DC>7.00 mm: CHW ± 0.05X45° mm.

Product	DC [mm]	CHW [mm]	DCON MS [mm]	APMX [mm]	OAL [mm]	NOF
S813HA2.0	2.00	0.00	6.00	6.00	57.0	3
S813HA2.5	2.50	0.08	6.00	7.00	57.0	3
S813HA3.0	3.00	0.08	6.00	7.00	57.0	3
S813HA3.5	3.50	0.08	6.00	7.00	57.0	3
S813HA4.0	4.00	0.13	6.00	8.00	57.0	3
S813HA4.5	4.50	0.13	6.00	8.00	57.0	3
S813HA5.0	5.00	0.13	6.00	10.00	57.0	3
S813HA6.0	6.00	0.13	6.00	10.00	57.0	3
S813HA7.0	7.00	0.13	8.00	13.00	63.0	3
S813HA8.0	8.00	0.20	8.00	16.00	63.0	3
S813HA9.0	9.00	0.20	10.00	16.00	72.0	3
S813HA10.0	10.00	0.20	10.00	19.00	72.0	3
S813HA12.0	12.00	0.20	12.00	22.00	83.0	3
S813HA14.0	14.00	0.20	14.00	22.00	83.0	3
S813HA16.0	16.00	0.20	16.00	26.00	92.0	3
S813HA18.0	18.00	0.20	18.00	26.00	92.0	3
S813HA20.0	20.00	0.30	20.00	32.00	104.0	3



S813HB



3-Flute Solid Carbide Slot End Mill, DIN 6535 HB Shank

Short cut length, 3-flute design provides high rigidity for milling standard slots to a P9 tolerance. The Weldon shank prevents the end mill from slipping in the toolholder. AlCrN coating improves performance and extends the tool life. Also suited for plunging and ramping milling.

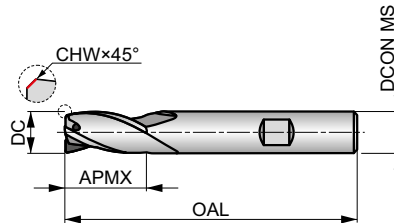

HM	N	NOF 3
	λ 28°	γ 9°
DIN 6535HB	AlCrN	
DIN 6527L		



Workpiece material group suitability, starting values for cutting speed (m/min) and Alpha Code. Tables with feed per tooth and correction factors can be found starting from page 112.

P1.1 ■ 166 J	P1.2 ■ 186 J	P1.3 ■ 192 J	P2.1 ■ 142 J	P2.2 ■ 125 J	P2.3 ■ 111 J	P3.1 ■ 115 J	P3.2 ■ 93 I	P3.3 ■ 78 I	P4.1 ■ 68 I	P4.2 ■ 59 I	P4.3 ▣ 47 I	M1.1 ■ 97 J	M1.2 ■ 81 J
M2.1 ■ 85 J	M2.2 ■ 71 I	M3.1 ▣ 79 I	M3.2 ▣ 68 I	M3.3 ▣ 61 I	M4.1 ▣ 60 I	K1.1 ■ 166 J	K1.2 ■ 123 J	K1.3 ■ 92 J	K2.1 ■ 170 J	K2.2 ■ 138 J	K2.3 ■ 110 I	K3.1 ■ 150 J	K3.2 ■ 115 J
K3.3 ■ 93 I	K4.1 ■ 140 I	K4.2 ■ 105 I	K4.3 ■ 77 I	K4.4 ■ 66 I	K4.5 ■ 56 I	K5.1 ■ 159 I	K5.2 ■ 118 I	K5.3 ■ 92 I	N1.1 ▣ 330 K	N1.2 ▣ 247 K	N1.3 ■ 166 K	N2.1 ■ 166 J	N2.2 ■ 148 J
N2.3 ■ 107 J	N3.1 ■ 173 J	N3.2 ■ 101 J	N3.3 ▣ 52 J	N4.1 ▣ 173 J	N4.2 ▣ 67 J	S1.1 ▣ 72 I	S1.2 ▣ 64 I	S2.1 ▣ 49 I	S3.1 ▣ 38 I	S4.1 ▣ 30 I			

DCON MS tolerance h6; DC ≤ 7.00 mm: CHW ± 0.03X45° mm; DC > 7.00 mm: CHW ± 0.05X45° mm.

Product	DC	CHW	DCON MS	APMX	OAL	NOF
	[mm]	[mm]	[mm]	[mm]	[mm]	
S813HB2.0	2.00	0.00	6.00	6.00	57.0	3
S813HB2.5	2.50	0.08	6.00	7.00	57.0	3
S813HB3.0	3.00	0.08	6.00	7.00	57.0	3
S813HB3.5	3.50	0.08	6.00	7.00	57.0	3
S813HB4.0	4.00	0.13	6.00	8.00	57.0	3
S813HB4.5	4.50	0.13	6.00	8.00	57.0	3
S813HB5.0	5.00	0.13	6.00	10.00	57.0	3
S813HB6.0	6.00	0.13	6.00	10.00	57.0	3
S813HB7.0	7.00	0.13	8.00	13.00	63.0	3
S813HB8.0	8.00	0.20	8.00	16.00	63.0	3
S813HB9.0	9.00	0.20	10.00	16.00	72.0	3
S813HB10.0	10.00	0.20	10.00	19.00	72.0	3
S813HB12.0	12.00	0.20	12.00	22.00	83.0	3
S813HB14.0	14.00	0.20	14.00	22.00	83.0	3
S813HB16.0	16.00	0.20	16.00	26.00	92.0	3
S813HB18.0	18.00	0.20	18.00	26.00	92.0	3
S813HB20.0	20.00	0.30	20.00	32.00	104.0	3



S823



3-Flute Solid Carbide Slot End Mill

Medium cut length, 3-flute design provides high rigidity for milling standard slots to a P9 tolerance and ramping operation. AlCrN coating improves performance and extends the tool life.

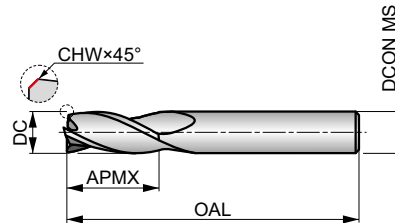

HM	N	NOF 3
	λ 28°	γ 9°
DIN 6535HA	AlCrN	
DORMER		



Workpiece material group suitability, starting values for cutting speed (m/min) and Alpha Code. Tables with feed per tooth and correction factors can be found starting from page 112.

P1.1 ■ 145 J	P1.2 ■ 162 J	P1.3 ■ 167 J	P2.1 ■ 124 J	P2.2 ■ 109 J	P2.3 ■ 97 I	P3.1 ■ 100 J	P3.2 ■ 81 I	P3.3 ■ 68 I	P4.1 ■ 60 I	P4.2 ■ 51 I	P4.3 ▣ 41 I	M1.1 ■ 84 J	M1.2 ■ 71 J
M2.1 ■ 75 J	M2.2 ■ 61 I	M3.1 ▣ 69 I	M3.2 ▣ 59 I	M3.3 ▣ 53 I	M4.1 ▣ 52 I	K1.1 ■ 144 J	K1.2 ■ 107 J	K1.3 ■ 80 J	K2.1 ■ 149 J	K2.2 ■ 121 J	K2.3 ■ 96 I	K3.1 ■ 132 J	K3.2 ■ 101 J
K3.3 ■ 81 I	K4.1 ■ 122 I	K4.2 ■ 92 I	K4.3 ■ 67 I	K4.4 ■ 58 I	K4.5 ■ 48 I	K5.1 ■ 138 I	K5.2 ■ 104 I	K5.3 ■ 80 I	N1.1 ▣ 284 K	N1.2 ▣ 214 K	N1.3 ■ 143 K	N2.1 ■ 143 J	N2.2 ■ 128 J
N2.3 ■ 92 J	N3.1 ■ 150 J	N3.2 ■ 87 J	N3.3 ▣ 45 J	N4.1 ▣ 150 J	N4.2 ▣ 58 J	S1.1 ▣ 113 I	S1.2 ▣ 100 I	S2.1 ▣ 77 I	S3.1 ▣ 58 I	S4.1 ▣ 45 I			

DCON MS tolerance h6; DC≤7.00 mm: CHW ± 0.03X45° mm; DC>7.00 mm: CHW ± 0.05X45° mm.

Product	DC [mm]	CHW [mm]	DCON MS [mm]	APMX [mm]	OAL [mm]	NOF
S8232.0	2.00	—	6.00	8.00	57.0	3
S8232.5	2.50	0.08	6.00	12.00	57.0	3
S8233.0	3.00	0.08	6.00	12.00	57.0	3
S8234.0	4.00	0.13	6.00	14.00	57.0	3
S8235.0	5.00	0.13	6.00	16.00	57.0	3
S8236.0	6.00	0.13	6.00	19.00	57.0	3
S8237.0	7.00	0.13	8.00	19.00	63.0	3
S8238.0	8.00	0.20	8.00	19.00	63.0	3
S8239.0	9.00	0.20	10.00	21.00	72.0	3
S82310.0	10.00	0.20	10.00	22.00	72.0	3
S82312.0	12.00	0.20	12.00	25.00	83.0	3
S82314.0	14.00	0.20	14.00	30.00	83.0	3
S82316.0	16.00	0.20	16.00	32.00	92.0	3
S82318.0	18.00	0.20	18.00	32.00	92.0	3
S82320.0	20.00	0.30	20.00	38.00	104.0	3



S804HA



4-Flute Solid Carbide End Mill, DIN 6535 HA Shank

Extra short cut length, 4-flute design provides high rigidity for shallow profile and plunge milling applications. AlCrN coating increases service life and improves performance.

HM	N	NOF 4
	λ 34°	γ 9°
DIN 6535HA	AlCrN	DC h10
	DIN 6527K	

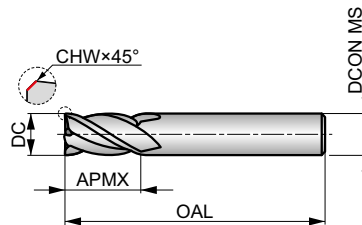

Workpiece material group suitability, starting values for cutting speed (m/min) and Alpha Code. Tables with feed per tooth and correction factors can be found starting from page 112.

P1.1 ■ 206 J	P1.2 ■ 230 J	P1.3 ■ 238 J	P2.1 ■ 176 J	P2.2 ■ 155 J	P2.3 ■ 137 I	P3.1 ■ 143 J	P3.2 ■ 114 I	P3.3 ■ 97 I	P4.1 ■ 84 I	P4.2 ■ 72 I	P4.3 ■ 58 I	M1.1 ■ 121 J	M1.2 ■ 102 J
M2.1 ■ 107 J	M2.2 ■ 89 I	M2.3 ▣ 75 I	M3.1 ■ 99 I	M3.2 ■ 85 I	M3.3 ▣ 76 I	M4.1 ▣ 75 I	M4.2 ▣ 63 I	K1.1 ■ 205 J	K1.2 ■ 152 J	K1.3 ■ 114 J	K2.1 ■ 210 J	K2.2 ■ 171 J	K2.3 ■ 137 I
K3.1 ■ 186 J	K3.2 ■ 143 J	K3.3 ■ 115 I	K4.1 ■ 173 I	K4.2 ■ 131 I	K4.3 ■ 95 I	K4.4 ■ 82 I	K4.5 ■ 68 I	K5.1 ■ 196 I	K5.2 ■ 147 I	K5.3 ■ 114 I	N1.1 ▣ 408 J	N1.2 ▣ 307 J	N1.3 ▣ 206 J
N2.1 ▣ 206 J	N2.2 ▣ 184 J	N2.3 ▣ 132 J	N3.1 ■ 215 J	N3.2 ■ 125 J	N3.3 ▣ 64 J	N4.1 ▣ 215 J	N4.2 ▣ 83 J	S1.1 ▣ 81 I	S1.2 ▣ 71 I	S2.1 ▣ 55 I	S3.1 ▣ 41 I	S4.1 ▣ 32 I	

DCON MS tolerance h6; DC ≤ 8.00 mm: CHW ± 0.03X45° mm; DC > 8.00 mm: CHW ± 0.05X45° mm.

Product	DC [mm]	CHW [mm]	DCON MS [mm]	APMX [mm]	OAL [mm]	NOF
S804HA2.0	2.00	–	6.00	4.00	50.0	4
S804HA3.0	3.00	0.08	6.00	5.00	50.0	4
S804HA4.0	4.00	0.13	6.00	8.00	54.0	4
S804HA5.0	5.00	0.13	6.00	9.00	54.0	4
S804HA6.0	6.00	0.13	6.00	10.00	54.0	4
S804HA8.0	8.00	0.13	8.00	12.00	58.0	4
S804HA10.0	10.00	0.20	10.00	14.00	66.0	4
S804HA12.0	12.00	0.20	12.00	16.00	73.0	4
S804HA16.0	16.00	0.20	16.00	22.00	82.0	4
S804HA20.0	20.00	0.30	20.00	26.00	92.0	4
S804HA25.0	25.00	0.30	25.00	32.00	121.0	4



S804HB



4-Flute Solid Carbide End Mill, DIN 6535 HB Shank

Extra short cut length, 4-flute design provides high rigidity for shallow profile and plunge milling applications. The Weldon shank prevents the end mill from slipping in the toolholder. AlCrN coating increases service life and improves performance.

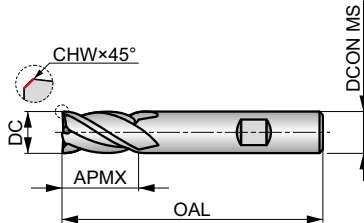

HM	N	NOF 4
	λ 34°	γ 9°
DIN 6535HB	AlCrN	DC h10
	DIN 6527K	



Workpiece material group suitability, starting values for cutting speed (m/min) and Alpha Code. Tables with feed per tooth and correction factors can be found starting from page 112.

P1.1 ■ 206 J	P1.2 ■ 230 J	P1.3 ■ 238 J	P2.1 ■ 176 J	P2.2 ■ 155 J	P2.3 ■ 137 I	P3.1 ■ 143 J	P3.2 ■ 114 I	P3.3 ■ 97 I	P4.1 ■ 84 I	P4.2 ■ 72 I	P4.3 ■ 58 I	M1.1 ■ 121 J	M1.2 ■ 102 J
M2.1 ■ 107 J	M2.2 ■ 89 I	M2.3 ▣ 75 I	M3.1 ■ 99 I	M3.2 ■ 85 I	M3.3 ▣ 76 I	M4.1 ▣ 75 I	M4.2 ▣ 63 I	K1.1 ■ 205 J	K1.2 ■ 152 J	K1.3 ■ 114 J	K2.1 ■ 210 J	K2.2 ■ 171 J	K2.3 ■ 137 I
K3.1 ■ 186 J	K3.2 ■ 143 J	K3.3 ■ 115 I	K4.1 ■ 173 I	K4.2 ■ 131 I	K4.3 ■ 95 I	K4.4 ■ 82 I	K4.5 ■ 68 I	K5.1 ■ 196 I	K5.2 ■ 147 I	K5.3 ■ 114 I	N1.1 ▣ 408 J	N1.2 ▣ 307 J	N1.3 ▣ 206 J
N2.1 ▣ 206 J	N2.2 ▣ 184 J	N2.3 ▣ 132 J	N3.1 ■ 215 J	N3.2 ■ 125 J	N3.3 ▣ 64 J	N4.1 ▣ 215 J	N4.2 ▣ 83 J	S1.1 ▣ 81 I	S1.2 ▣ 71 I	S2.1 ▣ 55 I	S3.1 ▣ 41 I	S4.1 ▣ 32 I	

DCON MS tolerance h6; DC≤8.00 mm: CHW ± 0.03X45° mm; DC>8.00 mm: CHW ± 0.05X45° mm.

Product	DC [mm]	CHW [mm]	DCON MS [mm]	APMX [mm]	OAL [mm]	NOF
S804HB2.0	2.00	—	6.00	4.00	50.0	4
S804HB3.0	3.00	0.08	6.00	5.00	50.0	4
S804HB4.0	4.00	0.13	6.00	8.00	54.0	4
S804HB5.0	5.00	0.13	6.00	9.00	54.0	4
S804HB6.0	6.00	0.13	6.00	10.00	54.0	4
S804HB8.0	8.00	0.13	8.00	12.00	58.0	4
S804HB10.0	10.00	0.20	10.00	14.00	66.0	4
S804HB12.0	12.00	0.20	12.00	16.00	73.0	4
S804HB16.0	16.00	0.20	16.00	22.00	82.0	4
S804HB20.0	20.00	0.30	20.00	26.00	92.0	4
S804HB25.0	25.00	0.30	25.00	32.00	121.0	4



S814HA



4-Flute Solid Carbide End Mill, DIN 6535 HA Shank

Short cut length, 4-flute design provides high rigidity for general profile and plunge milling applications. AlCrN coating improves performance and extends the tool life.

HM	N	NOF 4
	λ 34°	γ 9°
DIN 6535HA	AlCrN	
DIN 6527L	DC h10	

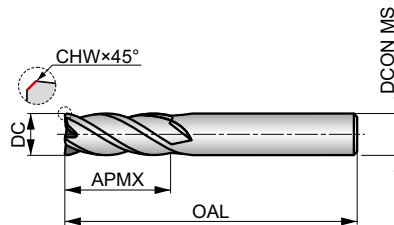

Workpiece material group suitability, starting values for cutting speed (m/min) and Alpha Code. Tables with feed per tooth and correction factors can be found starting from page 112.

P1.1 ■ 166 J	P1.2 ■ 186 J	P1.3 ■ 192 J	P2.1 ■ 142 J	P2.2 ■ 125 J	P2.3 ■ 111 J	P3.1 ■ 115 J	P3.2 ■ 93 J	P3.3 ■ 78 J	P4.1 ■ 68 J	P4.2 ■ 59 J	P4.3 ■ 47 J	M1.1 ■ 97 J	M1.2 ■ 81 J
M2.1 ■ 85 J	M2.2 ■ 71 J	M3.1 ■ 79 J	M3.2 ■ 68 J	M3.3 ■ 61 J	M4.1 ■ 60 J	K1.1 ■ 166 J	K1.2 ■ 123 J	K1.3 ■ 92 J	K2.1 ■ 170 J	K2.2 ■ 138 J	K2.3 ■ 110 J	K3.1 ■ 150 J	K3.2 ■ 115 J
K3.3 ■ 93 J	K4.1 ■ 140 J	K4.2 ■ 105 J	K4.3 ■ 77 J	K4.4 ■ 66 J	K4.5 ■ 56 J	K5.1 ■ 159 J	K5.2 ■ 118 J	K5.3 ■ 92 J	N1.1 ■ 330 J	N1.2 ■ 247 J	N1.3 ■ 166 J	N2.1 ■ 166 J	N2.2 ■ 148 J
N2.3 ■ 107 J	N3.1 ■ 173 J	N3.2 ■ 101 J	N3.3 ■ 52 J	N4.1 ■ 173 J	N4.2 ■ 67 J	S1.1 ■ 172 J	S1.2 ■ 64 J	S2.1 ■ 49 J	S3.1 ■ 38 J	S4.1 ■ 30 J			

DCON MS tolerance h6; DC ≤ 8.00 mm: CHW ± 0.03X45° mm; DC > 8.00 mm: CHW ± 0.05X45° mm.

Product	DC	CHW	DCON MS	APMX	OAL	NOF
	[mm]	[mm]	[mm]	[mm]	[mm]	
S814HA2.0	2.00	0.00	6.00	7.00	57.0	4
S814HA3.0	3.00	0.08	6.00	8.00	57.0	4
S814HA4.0	4.00	0.13	6.00	11.00	57.0	4
S814HA5.0	5.00	0.13	6.00	13.00	57.0	4
S814HA6.0	6.00	0.13	6.00	13.00	57.0	4
S814HA8.0	8.00	0.13	8.00	19.00	63.0	4
S814HA10.0	10.00	0.20	10.00	22.00	72.0	4
S814HA12.0	12.00	0.20	12.00	26.00	83.0	4
S814HA16.0	16.00	0.20	16.00	32.00	92.0	4
S814HA20.0	20.00	0.30	20.00	38.00	104.0	4
S814HA25.0	25.00	0.30	25.00	45.00	121.0	4



S814HB



4-Flute Solid Carbide End Mill, DIN 6535 HB Shank

Short cut length, 4-flute design provides high rigidity for general profile and plunge milling applications. The Weldon shank prevents the end mill from slipping in the toolholder. AlCrN coating improves performance and extends the tool life.

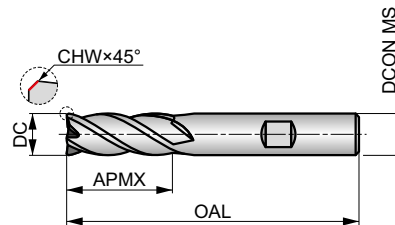

HM	N	NOF 4
	λ 34°	γ 9°
DIN 6535HB	AlCrN	DC h10
	DIN 6527L	



Workpiece material group suitability, starting values for cutting speed (m/min) and Alpha Code. Tables with feed per tooth and correction factors can be found starting from page 112.

P1.1 ■ 166 J	P1.2 ■ 186 J	P1.3 ■ 192 J	P2.1 ■ 142 J	P2.2 ■ 125 J	P2.3 ■ 111 I	P3.1 ■ 115 J	P3.2 ■ 93 I	P3.3 ■ 78 I	P4.1 ■ 68 I	P4.2 ■ 59 I	P4.3 ▣ 47 I	M1.1 ■ 97 J	M1.2 ■ 81 J
M2.1 ■ 85 J	M2.2 ■ 71 I	M3.1 ▣ 79 I	M3.2 ▣ 68 I	M3.3 ▣ 61 I	M4.1 ▣ 60 I	K1.1 ■ 166 J	K1.2 ■ 123 J	K1.3 ■ 92 J	K2.1 ■ 170 J	K2.2 ■ 138 J	K2.3 ■ 110 I	K3.1 ■ 150 J	K3.2 ■ 115 J
K3.3 ■ 93 I	K4.1 ■ 140 I	K4.2 ■ 105 I	K4.3 ■ 77 I	K4.4 ■ 66 I	K4.5 ■ 56 I	K5.1 ■ 159 I	K5.2 ■ 118 I	K5.3 ■ 92 I	N1.1 ▣ 330 J	N1.2 ▣ 247 J	N1.3 ▣ 166 J	N2.1 ▣ 166 J	N2.2 ▣ 148 J
N2.3 ▣ 107 J	N3.1 ■ 173 J	N3.2 ■ 101 J	N3.3 ▣ 52 J	N4.1 ▣ 173 J	N4.2 ▣ 67 J	S1.1 ▣ 172 I	S1.2 ▣ 64 I	S2.1 ▣ 49 I	S3.1 ▣ 38 I	S4.1 ▣ 30 I			

DCON MS tolerance h6; DC≤8.00 mm: CHW ± 0.03X45° mm; DC>8.00 mm: CHW ± 0.05X45° mm.

Product	DC [mm]	CHW [mm]	DCON MS [mm]	APMX [mm]	OAL [mm]	NOF
S814HB2.0	2.00	0.00	6.00	7.00	57.0	4
S814HB3.0	3.00	0.08	6.00	8.00	57.0	4
S814HB4.0	4.00	0.13	6.00	11.00	57.0	4
S814HB5.0	5.00	0.13	6.00	13.00	57.0	4
S814HB6.0	6.00	0.13	6.00	13.00	57.0	4
S814HB8.0	8.00	0.13	8.00	19.00	63.0	4
S814HB10.0	10.00	0.20	10.00	22.00	72.0	4
S814HB12.0	12.00	0.20	12.00	26.00	83.0	4
S814HB16.0	16.00	0.20	16.00	32.00	92.0	4
S814HB20.0	20.00	0.30	20.00	38.00	104.0	4
S814HB25.0	25.00	0.30	25.00	45.00	121.0	4



S501



2-Flute Solid Carbide Ball-Nosed End Mill

Short cut length, 2-flute design reduces vibrations and provides increased strength. Ball nosed geometry is designed for high performance contouring of complex surfaces. The X-CEED coating provides improved performance for milling difficult to machine materials.

HM	N	NOF 2
	λ 30°	γ 10°
DIN 6535HA	X-CEED	DC h9
	DORMER	

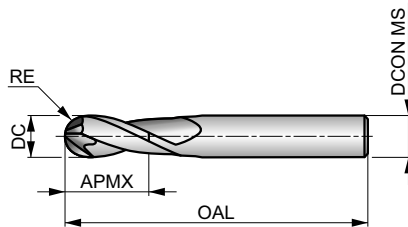

Workpiece material group suitability, starting values for cutting speed (m/min) and Alpha Code. Tables with feed per tooth and correction factors can be found starting from page 112.

P1.1 ■ 161 F	P1.2 ■ 181 F	P1.3 ■ 186 F	P2.1 ■ 138 F	P2.2 ■ 121 F	P2.3 ■ 108 F	P3.1 ■ 112 F	P3.2 ■ 90 F	P3.3 ■ 76 F	P4.1 ■ 66 F	P4.2 ■ 57 F	P4.3 ■ 46 F	M1.1 ■ 94 F	M1.2 ■ 79 F
M2.1 ■ 83 F	M2.2 ■ 69 F	M3.1 ■ 77 F	M3.2 ■ 66 F	M3.3 ■ 59 E	M4.1 ■ 58 E	K1.1 ■ 161 F	K1.2 ■ 119 F	K1.3 ■ 89 F	K2.1 ■ 165 F	K2.2 ■ 134 F	K2.3 ■ 107 F	K3.1 ■ 146 F	K3.2 ■ 112 F
K3.3 ■ 90 F	K4.1 ■ 136 F	K4.2 ■ 102 F	K4.3 ■ 75 F	K4.4 ■ 64 E	K4.5 ■ 54 E	K5.1 ■ 154 F	K5.2 ■ 115 F	K5.3 ■ 89 F	N1.1 ■ 355 G	N1.2 ■ 267 G	N1.3 ■ 179 G	N2.1 ■ 179 F	N2.2 ■ 160 F
N2.3 ■ 115 F	N3.1 ■ 187 F	N3.2 ■ 109 F	N3.3 ■ 56 F	N4.1 ■ 187 F	N4.2 ■ 72 F	S1.1 ■ 126 F	S1.2 ■ 112 F	S2.1 ■ 186 E	S3.1 ■ 165 E	S4.1 ■ 51 E			

DCON MS tolerance h6; RE ±0.01 mm.

Product	DC [mm]	RE [mm]	DCON MS [mm]	APMX [mm]	OAL [mm]	NOF
S5011.0	1.00	0.50	3.00	3.00	38.0	2
S5011.5	1.50	0.75	3.00	3.00	38.0	2
S5012.0	2.00	1.00	3.00	6.00	38.0	2
S5012.5	2.50	1.25	3.00	7.00	38.0	2
S5013.0	3.00	1.50	3.00	7.00	38.0	2
S5014.0	4.00	2.00	6.00	8.00	57.0	2
S5015.0	5.00	2.50	6.00	10.00	57.0	2
S5016.0	6.00	3.00	6.00	10.00	57.0	2
S5017.0	7.00	3.50	8.00	13.00	63.0	2
S5018.0	8.00	4.00	8.00	16.00	63.0	2
S5019.0	9.00	4.50	10.00	16.00	72.0	2
S50110.0	10.00	5.00	10.00	19.00	72.0	2
S50112.0	12.00	6.00	12.00	22.00	83.0	2
S50116.0	16.00	8.00	16.00	26.00	92.0	2



S511



4-Flute Solid Carbide Ball-Nosed End Mill, Extra Long Reach

Short cut length, extra long reach, 4-flute design provides high rigidity for increased strength and reduces vibrations in deeper applications. Ball nosed geometry is designed for high performance contouring of complex surfaces. X-CCEED coating provides improved performance for milling difficult to machine materials.

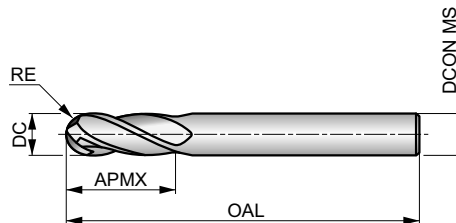

HM	N	NOF 4
	λ 30°	γ 10°
DIN 6535HA	X-CCEED	DC h9
	DORMER	



Workpiece material group suitability, starting values for cutting speed (m/min) and Alpha Code. Tables with feed per tooth and correction factors can be found starting from page 112.

P1.1 ■ 161 E	P1.2 ■ 181 E	P1.3 ■ 186 E	P2.1 ■ 138 E	P2.2 ■ 121 E	P2.3 ■ 108 E	P3.1 ■ 112 E	P3.2 ■ 90 E	P3.3 ■ 76 E	P4.1 ■ 66 E	P4.2 ■ 57 E	P4.3 ▣ 46 E	M1.1 ■ 94 E	M1.2 ■ 79 E
M2.1 ■ 83 E	M2.2 ■ 69 E	M3.1 ▣ 77 E	M3.2 ▣ 66 E	M3.3 ▣ 59 D	M4.1 ▣ 58 D	K1.1 ■ 161 E	K1.2 ■ 119 E	K1.3 ■ 89 E	K2.1 ■ 165 E	K2.2 ■ 134 E	K2.3 ■ 107 E	K3.1 ■ 146 E	K3.2 ■ 112 E
K3.3 ■ 90 E	K4.1 ■ 136 E	K4.2 ■ 102 E	K4.3 ■ 75 E	K4.4 ■ 64 D	K4.5 ■ 54 D	K5.1 ■ 154 E	K5.2 ■ 115 E	K5.3 ■ 89 E	N1.1 ▣ 355 F	N1.2 ▣ 267 F	N1.3 ▣ 179 F	N2.1 ▣ 179 E	N2.2 ▣ 160 E
N2.3 ▣ 115 E	N3.1 ■ 187 E	N3.2 ■ 109 E	N3.3 ▣ 56 E	N4.1 ▣ 187 E	N4.2 ▣ 72 E	S1.1 ▣ 126 E	S1.2 ▣ 112 E	S2.1 ▣ 86 D	S3.1 ▣ 65 D	S4.1 ▣ 51 D			

DCON MS tolerance h6; RE +0/-0.01 mm.

Product	DC [mm]	RE [mm]	DCON MS [mm]	APMX [mm]	OAL [mm]	NOF
S5113.0	3.00	1.50	6.00	8.00	80.0	4
S5114.0	4.00	2.00	6.00	11.00	80.0	4
S5115.0	5.00	2.50	6.00	13.00	80.0	4
S5116.0	6.00	3.00	6.00	13.00	80.0	4
S5117.0	7.00	3.50	8.00	16.00	100.0	4
S5118.0	8.00	4.00	8.00	19.00	100.0	4
S5119.0	9.00	4.50	10.00	19.00	100.0	4
S51110.0	10.00	5.00	10.00	22.00	100.0	4
S51112.0	12.00	6.00	12.00	26.00	100.0	4
S51116.0	16.00	8.00	16.00	32.00	100.0	4



S902



2-Flute Solid Carbide End Mill

Medium cut length, 2-flute design with 30° helix provides high rigidity for milling standard slots.

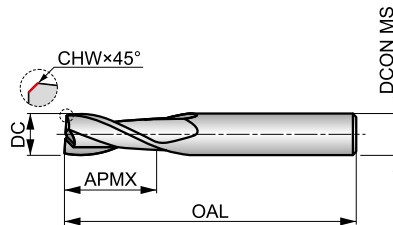

HM	N	NOF 2
	λ 30°	γ 12°
DIN 6535HA	Bright	DC h10
	DORMER	



Workpiece material group suitability, starting values for cutting speed (m/min) and Alpha Code. Tables with feed per tooth and correction factors can be found starting from page 112.

P1.1 ■ 106 K	P1.2 ■ 119 K	P1.3 ■ 123 K	P2.1 ■ 91 K	P2.2 ■ 80 K	P2.3 ▣ 71 J	P3.1 ■ 66 K	P3.2 ■ 53 J	P3.3 ▣ 45 J	P4.1 ■ 40 J	P4.2 ▣ 34 J	K1.1 ■ 80 K	K1.2 ▣ 59 K	K1.3 ▣ 44 K
K2.1 ■ 98 K	K2.2 ■ 80 K	K2.3 ▣ 64 J	K3.1 ■ 87 K	K3.2 ■ 67 K	K3.3 ▣ 54 J	K4.1 ■ 81 J	K4.2 ■ 61 J	K4.3 ▣ 45 J	K4.4 ▣ 38 J	K4.5 ▣ 32 J	K5.1 ■ 91 J	K5.2 ■ 69 J	K5.3 ▣ 53 J
N1.1 ▣ 355 K	N1.2 ■ 267 K	N1.3 ■ 179 K	N2.1 ■ 179 K	N2.2 ▣ 160 K	N2.3 ▣ 115 K	N3.1 ■ 187 K	N3.2 ■ 109 K	N3.3 ■ 56 K	N4.1 ▣ 187 K	N4.2 ▣ 72 K	S1.1 ■ 38 J	S1.2 ▣ 36 J	S1.3 ▣ 15 J

DCON MS tolerance h6; DC ≤ 10.00 mm: CHW ± 0.03X45° mm; DC > 10.00 mm: CHW ± 0.05X45° mm.

Product	DC [mm]	CHW [mm]	DCON MS [mm]	APMX [mm]	OAL [mm]	NOF
S9022.0	2.00	0.08	3.00	6.00	38.0	2
S9022.5	2.50	0.08	3.00	9.00	38.0	2
S9023.0	3.00	0.08	3.00	12.00	38.0	2
S9024.0	4.00	0.08	4.00	14.00	50.0	2
S9025.0	5.00	0.13	5.00	16.00	50.0	2
S9026.0	6.00	0.13	6.00	19.00	57.0	2
S9027.0	7.00	0.13	8.00	19.00	63.0	2
S9028.0	8.00	0.13	8.00	19.00	63.0	2
S9029.0	9.00	0.13	10.00	21.00	72.0	2
S90210.0	10.00	0.18	10.00	22.00	72.0	2
S90212.0	12.00	0.20	12.00	25.00	73.0	2
S90214.0	14.00	0.20	14.00	30.00	83.0	2
S90216.0	16.00	0.20	16.00	32.00	92.0	2
S90218.0	18.00	0.20	18.00	32.00	92.0	2
S90220.0	20.00	0.30	20.00	38.00	104.0	2



S922



2-Flute Solid Carbide End Mill

Medium cut length, 2-flute design with 30° helix provides high rigidity for milling standard slots. Cylindrical shank for cutting diameter up to 5 mm. TiAlN coating for higher temperature resistance and longer tool life.

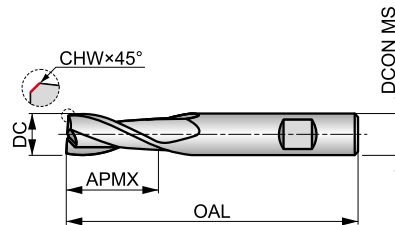

HM	N	NOF 2
	λ 30°	γ 12°
DIN 6535HB	TiAlN	DC h10



Workpiece material group suitability, starting values for cutting speed (m/min) and Alpha Code. Tables with feed per tooth and correction factors can be found starting from page 112.

P1.1 ■ 132 K	P1.2 ■ 148 K	P1.3 ■ 153 K	P2.1 ■ 113 K	P2.2 ■ 100 K	P2.3 ■ 88 J	P3.1 ■ 98 K	P3.2 ■ 79 J	P3.3 ■ 67 J	P4.1 ■ 59 J	P4.2 ■ 50 J	P4.3 ▣ 41 J	K1.1 ■ 100 K	K1.2 ■ 74 K
K1.3 ■ 56 K	K2.1 ■ 107 K	K2.2 ■ 87 K	K2.3 ■ 70 J	K3.1 ■ 95 K	K3.2 ■ 72 K	K3.3 ■ 59 J	K4.1 ■ 88 J	K4.2 ■ 67 J	K4.3 ■ 49 J	K4.4 ■ 42 J	K4.5 ■ 35 J	K5.1 ■ 100 J	K5.2 ■ 75 J
K5.3 ■ 58 J	N1.1 ▣ 1296 K	N1.2 ▣ 1222 K	N1.3 ■ 149 K	N2.1 ■ 149 K	N2.2 ■ 133 K	N2.3 ■ 96 K	N3.1 ■ 156 K	N3.2 ■ 91 K	N3.3 ▣ 147 K	N4.1 ▣ 156 K	N4.2 ▣ 160 K	N4.3 ▣ 164 K	S1.1 ■ 47 J
S1.2 ▣ 45 J	S1.3 ▣ 20 J												

DCON MS tolerance h6; DC≤10.00 mm: CHW ± 0.03X45° mm; DC>10.00 mm: CHW ± 0.05X45° mm.
Products from this series are also available in set. Please see S991.

Product	DC	CHW	DCON MS	APMX	OAL	NOF
	[mm]	[mm]	[mm]	[mm]	[mm]	
S9222.0 ¹⁾	2.00	0.08	3.00	6.00	38.0	2
S9222.5 ¹⁾	2.50	0.08	3.00	9.00	38.0	2
S9223.0 ¹⁾	3.00	0.08	3.00	12.00	38.0	2
S9224.0 ¹⁾	4.00	0.08	4.00	14.00	50.0	2
S9225.0 ¹⁾	5.00	0.13	5.00	16.00	50.0	2
S9226.0	6.00	0.13	6.00	19.00	57.0	2
S9227.0	7.00	0.13	8.00	19.00	63.0	2
S9228.0	8.00	0.13	8.00	19.00	63.0	2
S9229.0	9.00	0.13	10.00	21.00	72.0	2
S92210.0	10.00	0.18	10.00	22.00	72.0	2
S92212.0	12.00	0.20	12.00	25.00	73.0	2
S92214.0	14.00	0.20	14.00	30.00	83.0	2
S92216.0	16.00	0.20	16.00	32.00	92.0	2
S92218.0	18.00	0.20	18.00	32.00	92.0	2
S92220.0	20.00	0.30	20.00	38.00	104.0	2

¹⁾ Cylindrical shank.



S903



3-Flute Solid Carbide End Mill

Medium cut length, 3-flute design with 30° helix and provides high rigidity for milling standard slots.



HM	N	NOF 3
	λ 30°	γ 12°
DIN 6535HA	Bright	DC h10
	DORMER	

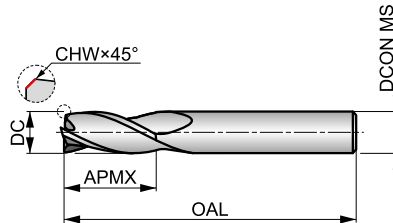

Workpiece material group suitability, starting values for cutting speed (m/min) and Alpha Code. Tables with feed per tooth and correction factors can be found starting from page 112.

P1.1 ■ 106 J	P1.2 ■ 119 J	P1.3 ■ 123 J	P2.1 ■ 91 J	P2.2 ■ 80 J	P2.3 ■ 71 I	P3.1 ■ 66 J	P3.2 ■ 53 I	P3.3 ■ 45 I	P4.1 ■ 40 I	P4.2 ■ 34 I	K1.1 ■ 80 J	K1.2 ■ 59 J	K1.3 ■ 44 J
K2.1 ■ 98 J	K2.2 ■ 80 J	K2.3 ■ 64 I	K3.1 ■ 87 J	K3.2 ■ 67 J	K3.3 ■ 54 I	K4.1 ■ 81 I	K4.2 ■ 61 I	K4.3 ■ 45 I	K4.4 ■ 38 I	K4.5 ■ 32 I	K5.1 ■ 91 I	K5.2 ■ 69 I	K5.3 ■ 53 I
N1.1 ■ 355 K	N1.2 ■ 267 K	N1.3 ■ 179 K	N2.1 ■ 179 J	N2.2 ■ 160 J	N2.3 ■ 115 J	N3.1 ■ 187 J	N3.2 ■ 109 J	N3.3 ■ 56 J	N4.1 ■ 187 J	N4.2 ■ 72 J	S1.1 ■ 38 I	S1.2 ■ 36 I	S1.3 ■ 43 I

DCON MS tolerance h6; DC ≤ 9.00 mm: CHW ± 0.03X45° mm; DC > 9.00 mm: CHW ± 0.05X45° mm.

Product	DC [mm]	CHW [mm]	DCON MS [mm]	APMX [mm]	OAL [mm]	NOF
S9032.0	2.00	0.08	3.00	6.00	38.0	3
S9032.5	2.50	0.08	3.00	9.00	38.0	3
S9033.0	3.00	0.08	3.00	12.00	38.0	3
S9034.0	4.00	0.08	4.00	14.00	50.0	3
S9035.0	5.00	0.13	5.00	16.00	50.0	3
S9036.0	6.00	0.13	6.00	19.00	57.0	3
S9037.0	7.00	0.13	8.00	19.00	63.0	3
S9038.0	8.00	0.13	8.00	19.00	63.0	3
S9039.0	9.00	0.13	10.00	21.00	72.0	3
S90310.0	10.00	0.20	10.00	22.00	72.0	3
S90312.0	12.00	0.20	12.00	25.00	73.0	3
S90314.0	14.00	0.20	14.00	30.00	83.0	3
S90316.0	16.00	0.20	16.00	32.00	92.0	3
S90318.0	18.00	0.20	18.00	32.00	92.0	3
S90320.0	20.00	0.30	20.00	38.00	104.0	3



S933



3-Flute Solid Carbide End Mill

Medium cut length, 3-flute design with 30° helix provides high rigidity for milling standard slots. Cylindrical shank for cutting diameter up to 5 mm. TiALN coating for higher temperature resistance and longer tool life.

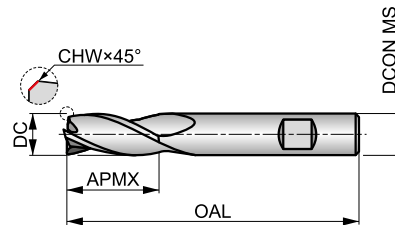

HM	N	NOF 3
	λ 30°	γ 12°
DIN 6535HB	TiALN	DC h10
	DORMER	



Workpiece material group suitability, starting values for cutting speed (m/min) and Alpha Code. Tables with feed per tooth and correction factors can be found starting from page 112.

P1.1 ■ 132 J	P1.2 ■ 148 J	P1.3 ■ 153 J	P2.1 ■ 113 J	P2.2 ■ 100 J	P2.3 ■ 88 I	P3.1 ■ 98 J	P3.2 ■ 79 I	P3.3 ■ 67 I	P4.1 ■ 59 I	P4.2 ■ 50 I	P4.3 ■ 41 I	K1.1 ■ 100 J	K1.2 ■ 74 J
K1.3 ■ 56 J	K2.1 ■ 107 J	K2.2 ■ 87 J	K2.3 ■ 70 I	K3.1 ■ 95 J	K3.2 ■ 72 J	K3.3 ■ 59 I	K4.1 ■ 88 I	K4.2 ■ 67 I	K4.3 ■ 49 I	K4.4 ■ 42 I	K4.5 ■ 35 I	K5.1 ■ 100 I	K5.2 ■ 75 I
K5.3 ■ 58 I	N1.1 ■ 296 K	N1.2 ■ 222 K	N1.3 ■ 149 K	N2.1 ■ 149 J	N2.2 ■ 133 J	N2.3 ■ 96 J	N3.1 ■ 156 J	N3.2 ■ 91 J	N3.3 ■ 47 J	N4.1 ■ 156 J	N4.2 ■ 60 J	N4.3 ■ 64 J	S1.1 ■ 47 I
S1.2 ■ 45 I	S1.3 ■ 20 I												

DCON MS tolerance h6; DC≤9.00 mm: CHW ± 0.03X45° mm; DC>9.00 mm: CHW ± 0.05X45° mm.
Products from this series are also available in set. Please see S991.

Product	DC	CHW	DCON MS	APMX	OAL	NOF
	[mm]	[mm]	[mm]	[mm]	[mm]	
S9332.0 ¹⁾	2.00	0.08	3.00	6.00	38.0	3
S9332.5 ¹⁾	2.50	0.08	3.00	9.00	38.0	3
S9333.0 ¹⁾	3.00	0.08	3.00	12.00	38.0	3
S9334.0 ¹⁾	4.00	0.08	4.00	14.00	50.0	3
S9335.0 ¹⁾	5.00	0.13	5.00	16.00	50.0	3
S9336.0	6.00	0.13	6.00	19.00	57.0	3
S9337.0	7.00	0.13	8.00	19.00	63.0	3
S9338.0	8.00	0.13	8.00	19.00	63.0	3
S9339.0	9.00	0.13	10.00	21.00	72.0	3
S93310.0	10.00	0.20	10.00	22.00	72.0	3
S93312.0	12.00	0.20	12.00	25.00	73.0	3
S93314.0	14.00	0.20	14.00	30.00	83.0	3
S93316.0	16.00	0.20	16.00	32.00	92.0	3
S93318.0	18.00	0.20	18.00	32.00	92.0	3
S93320.0	20.00	0.30	20.00	38.00	104.0	3

¹⁾ Cylindrical shank.



S904



4-Flute Solid Carbide End Mill

Medium cut length, 4-flute design with 30° helix provides high rigidity for milling standard slots.

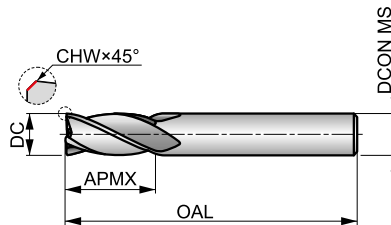

HM	N	NOF 4
	λ 30°	γ 12°
DIN 6535HA	Bright	DC h12
	DORMER	



Workpiece material group suitability, starting values for cutting speed (m/min) and Alpha Code. Tables with feed per tooth and correction factors can be found starting from page 112.

P1.1 ■ 106 J	P1.2 ■ 119 J	P1.3 ■ 123 J	P2.1 ■ 91 J	P2.2 ■ 80 J	P2.3 ■ 71 I	P3.1 ■ 66 J	P3.2 ■ 53 I	P3.3 ■ 45 I	P4.1 ■ 40 I	P4.2 ■ 34 I	P4.3 ■ 18 I	K1.1 ■ 80 J	K1.2 ■ 59 J
K1.3 ■ 44 J	K2.1 ■ 98 J	K2.2 ■ 80 J	K2.3 ■ 64 I	K3.1 ■ 87 J	K3.2 ■ 67 J	K3.3 ■ 54 I	K4.1 ■ 81 I	K4.2 ■ 61 I	K4.3 ■ 45 I	K4.4 ■ 38 I	K4.5 ■ 32 I	K5.1 ■ 91 I	K5.2 ■ 69 I
K5.3 ■ 53 I	N1.1 ■ 355 J	N1.2 ■ 267 J	N1.3 ■ 179 J	N2.1 ■ 179 J	N2.2 ■ 160 J	N2.3 ■ 115 J	N3.1 ■ 187 J	N3.2 ■ 109 J	N3.3 ■ 56 J	N4.1 ■ 187 J	N4.2 ■ 172 J	S1.1 ■ 38 I	S1.2 ■ 36 I
S1.3 ■ 43 I	S2.1 ■ 40 I	S2.2 ■ 35 I	S3.1 ■ 30 I	S3.2 ■ 25 I	S4.1 ■ 23 I	S4.2 ■ 20 I							

DCON MS tolerance h6; DC ≤ 9.00 mm: CHW ± 0.03X45° mm; DC > 9.00 mm: CHW ± 0.05X45° mm.

Product	DC [mm]	CHW [mm]	DCON MS [mm]	APMX [mm]	OAL [mm]	NOF
S9042.0	2.00	0.08	3.00	6.00	38.0	4
S9042.5	2.50	0.08	3.00	9.00	38.0	4
S9043.0	3.00	0.08	3.00	12.00	38.0	4
S9044.0	4.00	0.08	4.00	14.00	50.0	4
S9045.0	5.00	0.13	5.00	16.00	50.0	4
S9046.0	6.00	0.13	6.00	19.00	57.0	4
S9047.0	7.00	0.13	8.00	19.00	63.0	4
S9048.0	8.00	0.13	8.00	19.00	63.0	4
S9049.0	9.00	0.13	10.00	21.00	72.0	4
S90410.0	10.00	0.20	10.00	22.00	72.0	4
S90412.0	12.00	0.20	12.00	25.00	73.0	4
S90414.0	14.00	0.20	14.00	30.00	83.0	4
S90416.0	16.00	0.20	16.00	32.00	92.0	4
S90418.0	18.00	0.20	18.00	32.00	92.0	4
S90420.0	20.00	0.30	20.00	38.00	104.0	4



S944



4-Flute Solid Carbide End Mill

Medium cut length, 4-flute design with 30° helix provides high rigidity for milling standard slots. Cylindrical shank for cutting diameter up to 5 mm. TiALN coating for higher temperature resistance and longer tool life.

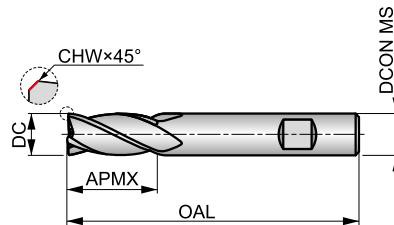

HM	N	NOF 4
	λ 30°	γ 12°
DIN 6535HB	TiALN	DC h12



Workpiece material group suitability, starting values for cutting speed (m/min) and Alpha Code. Tables with feed per tooth and correction factors can be found starting from page 112.

P1.1 ■ 132 J	P1.2 ■ 148 J	P1.3 ■ 153 J	P2.1 ■ 113 J	P2.2 ■ 100 J	P2.3 ■ 88 I	P3.1 ■ 98 J	P3.2 ■ 79 I	P3.3 ■ 67 I	P4.1 ■ 59 I	P4.2 ■ 50 I	P4.3 ■ 41 I	K1.1 ■ 100 J	K1.2 ■ 74 J
K1.3 ■ 56 J	K2.1 ■ 107 J	K2.2 ■ 87 J	K2.3 ■ 70 I	K3.1 ■ 95 J	K3.2 ■ 72 J	K3.3 ■ 59 I	K4.1 ■ 88 I	K4.2 ■ 67 I	K4.3 ■ 49 I	K4.4 ■ 42 I	K4.5 ■ 35 I	K5.1 ■ 100 I	K5.2 ■ 75 I
K5.3 ■ 58 I	N1.1 ■ 1296 J	N1.2 ■ 222 J	N1.3 ■ 149 J	N2.1 ■ 149 J	N2.2 ■ 133 J	N2.3 ■ 96 J	N3.1 ■ 156 J	N3.2 ■ 91 J	N3.3 ■ 47 J	N4.1 ■ 156 J	N4.2 ■ 60 J	N4.3 ■ 64 J	S1.1 ■ 47 I
S1.2 ■ 45 I	S1.3 ■ 45 I	S2.1 ■ 60 I	S2.2 ■ 49 I	S3.1 ■ 45 I	S3.2 ■ 35 I	S4.1 ■ 35 I	S4.2 ■ 28 I						

DCON MS tolerance h6; DC≤9.00 mm: CHW ± 0.03X45° mm; DC>9.00 mm: CHW ± 0.05X45° mm.
Products from this series are also available in set. Please see S991.

Product	DC	CHW	DCON MS	APMX	OAL	NOF
	[mm]	[mm]	[mm]	[mm]	[mm]	
S9442.0 ¹⁾	2.00	0.08	3.00	6.00	38.0	4
S9442.5 ¹⁾	2.50	0.08	3.00	9.00	38.0	4
S9443.0 ¹⁾	3.00	0.08	3.00	12.00	38.0	4
S9444.0 ¹⁾	4.00	0.08	4.00	14.00	50.0	4
S9445.0 ¹⁾	5.00	0.13	5.00	16.00	50.0	4
S9446.0	6.00	0.13	6.00	19.00	57.0	4
S9447.0	7.00	0.13	8.00	19.00	63.0	4
S9448.0	8.00	0.13	8.00	19.00	63.0	4
S9449.0	9.00	0.13	10.00	21.00	72.0	4
S94410.0	10.00	0.20	10.00	22.00	72.0	4
S94412.0	12.00	0.20	12.00	25.00	73.0	4
S94414.0	14.00	0.20	14.00	30.00	83.0	4
S94416.0	16.00	0.20	16.00	32.00	92.0	4
S94418.0	18.00	0.20	18.00	32.00	92.0	4
S94420.0	20.00	0.30	20.00	38.00	104.0	4

¹⁾ Cylindrical shank.



S991



Set of Solid Carbide End Mills

Sets of solid carbide End Mills with TiALN coating. Range of S922, S933 or S944 (2, 3 or 4 flute). Sets contain Ø3, 4, 5, 6, 8 and 10 mm. Carried in a plastic container for good overview.

A = Product Family, B = No. in Set, C = Diameters in Set.

Product	A	B	C
S991SET922	S922	6	3.00 mm, 4.00 mm, 5.00 mm, 6.00 mm, 8.00 mm, 10.00 mm
S991SET933	S933	6	3.00 mm, 4.00 mm, 5.00 mm, 6.00 mm, 8.00 mm, 10.00 mm
S991SET944	S944	6	3.00 mm, 4.00 mm, 5.00 mm, 6.00 mm, 8.00 mm, 10.00 mm



DORMER PRAMET

FOLLOW US



SHARE



LIKE



COMMENT



TAG



RE-TWEET





SOLID HM MILLS – FEED PER TOOTH TABLE

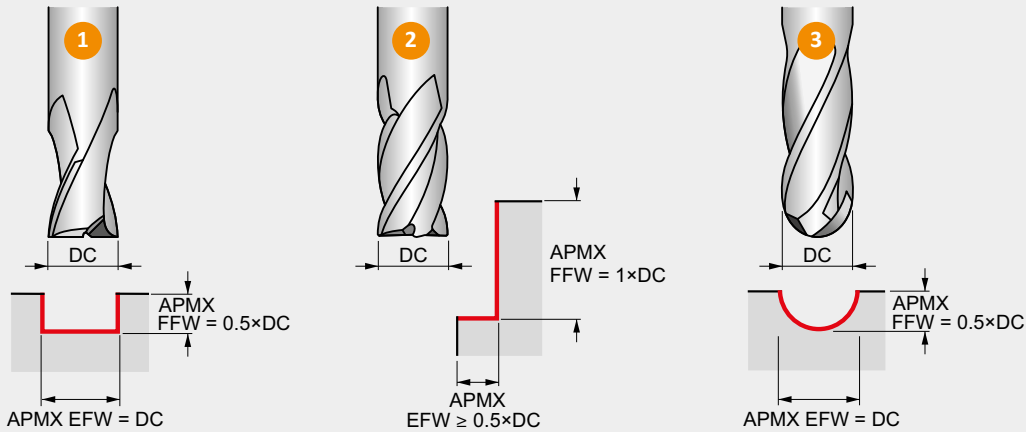

Feed per tooth (f_z in mm/rev) depending on the working conditions it might be necessary to adjust these values $\pm 25\%$.

ONLY if plunging into solid material with a centre cutting end mill the values in this table should be considered as f_n (feed per revolution).

How to use this table to find the feed per tooth (f_z):

1. Find your Alpha Code on the product page (example: 199K, "K" is the Alpha Code).
2. Find the closest diameter for your cutting application in the top row of the table.
3. Find your Alpha Code in the left column of the table.
4. The intersection (cell) of the Diameter and Alpha Code is the feed per tooth (f_z).

**FOR SOLID
CARBIDE
MILLING
CUTTERS ONLY**

		\varnothing DC [mm]																
		1.00	2.00	3.00	4.00	5.00	6.00	7.00	8.00	9.00	10.00	12.00	14.00	16.00	18.00	20.00	22.00	25.00
Feed rates	A	0.002	0.003	0.004	0.005	0.006	0.007	0.008	0.009	0.010	0.011	0.014	0.015	0.017	0.019	0.021	0.025	0.028
	B	0.002	0.003	0.004	0.005	0.006	0.007	0.008	0.009	0.010	0.011	0.014	0.015	0.017	0.019	0.021	0.025	0.028
	C	0.002	0.003	0.004	0.005	0.006	0.007	0.008	0.009	0.010	0.011	0.014	0.015	0.017	0.019	0.021	0.025	0.028
	D	0.002	0.003	0.004	0.005	0.007	0.008	0.009	0.010	0.011	0.012	0.014	0.015	0.017	0.019	0.021	0.025	0.028
	E	0.002	0.003	0.004	0.008	0.009	0.012	0.013	0.014	0.015	0.016	0.019	0.021	0.024	0.026	0.028	0.030	0.034
	F	0.002	0.003	0.006	0.010	0.013	0.016	0.017	0.019	0.021	0.022	0.026	0.029	0.032	0.035	0.039	0.042	0.047
	G	0.002	0.005	0.008	0.014	0.018	0.022	0.024	0.026	0.028	0.031	0.035	0.040	0.044	0.048	0.053	0.057	0.064
	I	0.003	0.006	0.011	0.019	0.024	0.030	0.032	0.036	0.039	0.042	0.049	0.054	0.061	0.066	0.073	0.079	0.088
	J	0.004	0.009	0.014	0.026	0.033	0.041	0.044	0.048	0.053	0.057	0.066	0.074	0.083	0.090	0.099	0.107	0.120
	K	0.006	0.012	0.019	0.035	0.044	0.054	0.059	0.064	0.070	0.076	0.088	0.098	0.110	0.120	0.132	0.142	0.160
	N	0.008	0.016	0.025	0.047	0.058	0.072	0.078	0.086	0.094	0.101	0.117	0.131	0.146	0.160	0.175	0.189	0.212
	O	0.010	0.021	0.034	0.062	0.078	0.096	0.104	0.114	0.124	0.135	0.156	0.174	0.195	0.213	0.233	0.252	0.283
	P	0.014	0.028	0.045	0.083	0.104	0.128	0.138	0.152	0.166	0.180	0.207	0.231	0.259	0.283	0.311	0.335	0.376
	R	0.018	0.037	0.060	0.110	0.138	0.170	0.184	0.202	0.221	0.239	0.276	0.308	0.345	0.377	0.414	0.446	0.501
	S	0.024	0.049	0.080	0.147	0.183	0.226	0.245	0.269	0.294	0.318	0.367	0.410	0.459	0.502	0.550	0.593	0.667



SOLID HM MILLS – FEED PER TOOTH TABLE

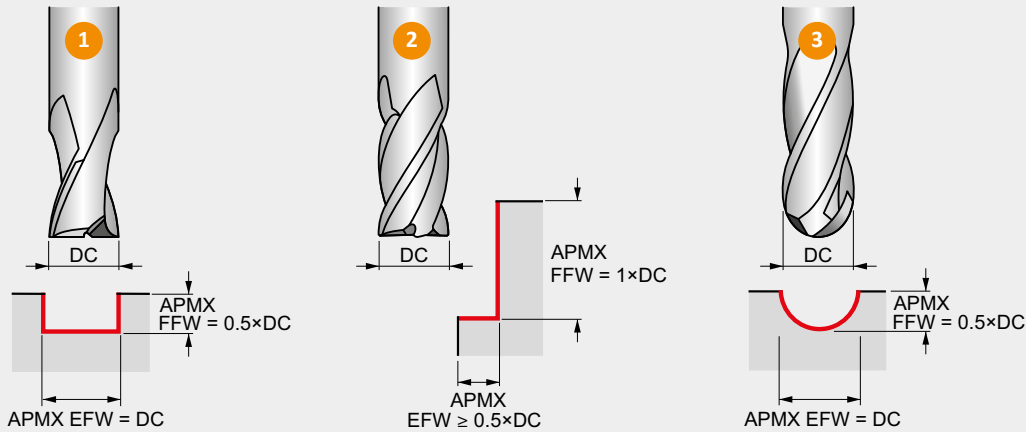

Feed per tooth (IPT or inch/tooth) depending on the working conditions it might be necessary to adjust these values $\pm 25\%$.

ONLY if plunging into solid material with a centre cutting end mill the values in this table should be considered as IPR (feed in inch per revolution).

How to use this table to find the feed per tooth (IPT):

1. Find your Alpha Code on the product page (example: 653K, "K" is the Alpha Code).
2. Find the closest diameter for your cutting application in the top row of the table.
3. Find your Alpha Code in the left column of the table.
4. The intersection (cell) of the Diameter and Alpha Code is the feed per tooth (IPT).

**FOR SOLID
CARBIDE
MILLING
CUTTERS ONLY**

		\varnothing DC [inch]															
		1/16	3/32	1/8	5/32	3/16	7/32	1/4	5/16	3/8	7/16	1/2	9/16	5/8	3/4	7/8	1
		.0625	.0938	.1250	.1563	.1875	.2188	.2500	.3125	.3750	.4375	.5000	.5625	.6250	.7500	.8750	1.0000
Feed rates	A	.0001	.0001	.0002	.0002	.0002	.0002	.0003	.0003	.0004	.0005	.0005	.0006	.0007	.0008	.0010	.0011
	B	.0001	.0001	.0002	.0002	.0002	.0002	.0003	.0003	.0004	.0005	.0005	.0006	.0007	.0008	.0010	.0011
	C	.0001	.0001	.0002	.0002	.0002	.0002	.0003	.0003	.0004	.0005	.0005	.0006	.0007	.0008	.0010	.0011
	D	.0001	.0001	.0002	.0002	.0002	.0003	.0004	.0004	.0004	.0005	.0006	.0006	.0007	.0008	.0010	.0011
	E	.0001	.0001	.0002	.0003	.0004	.0004	.0005	.0006	.0006	.0007	.0007	.0009	.0009	.0011	.0012	.0013
	F	.0001	.0002	.0002	.0004	.0005	.0006	.0006	.0007	.0009	.0009	.0011	.0012	.0013	.0015	.0017	.0019
	G	.0002	.0002	.0004	.0006	.0007	.0007	.0009	.0010	.0012	.0013	.0015	.0016	.0017	.0020	.0023	.0025
	I	.0002	.0003	.0005	.0007	.0009	.0011	.0012	.0014	.0016	.0018	.0020	.0022	.0024	.0028	.0031	.0035
	J	.0003	.0004	.0007	.0010	.0012	.0014	.0017	.0019	.0022	.0024	.0027	.0030	.0032	.0037	.0043	.0047
	K	.0004	.0006	.0009	.0014	.0016	.0019	.0022	.0025	.0029	.0032	.0036	.0040	.0043	.0050	.0056	.0063
	N	.0005	.0007	.0011	.0019	.0022	.0025	.0029	.0034	.0038	.0043	.0048	.0053	.0057	.0066	.0075	.0083
	O	.0006	.0010	.0015	.0024	.0029	.0034	.0039	.0045	.0051	.0057	.0063	.0070	.0076	.0088	.0100	.0111
	P	.0008	.0014	.0020	.0033	.0038	.0045	.0052	.0060	.0068	.0076	.0084	.0094	.0100	.0117	.0133	.0148
	R	.0011	.0018	.0027	.0043	.0051	.0060	.0069	.0080	.0091	.0101	.0112	.0125	.0134	.0156	.0177	.0197
	S	.0015	.0024	.0036	.0058	.0067	.0080	.0091	.0106	.0120	.0135	.0149	.0166	.0178	.0207	.0236	.0263



SOLID HM MILLS – CORRECTION FACTORS

1 Slot Milling

Correction factors for cutting speed v_c and feed per tooth f_z for slot milling operations at different depths of cut.

APMX FFW / DC	25 %	50 %	100 %	150 %
	1.25	1.00	0.75	0.50
	1.25	1.00	0.75	0.50

2 Shoulder Milling

Correction factors for cutting speed v_c and feed per tooth f_z for square shoulder milling with <50% radial immersion.

APMX EFW / DC	5 %	10 %	15 %	20 %	25 %	30 %	40 %	≥ 50 %
	1.48	1.35	1.27	1.22	1.19	1.16	1.11	1.00
	2.29	1.67	1.40	1.25	1.15	1.09	1.02	1.00

We recommend to avoid milling with 50% radial immersion.

3a Plain Copy Milling (with Ball Nose Cutters)

Correction factors for cutting speed v_c for plain copy milling at different depths of cut

APMX FFW / DC	5 %	10 %	15 %	20 %	25 %	30 %	40 %	50 %
	2.29	1.67	1.40	1.25	1.15	1.09	1.02	1.00

3b

Line offset f_e (step-over distance) for achieving a theoretical surface roughness R_{th}

DC		2	4	8	16	32	63	125	250
2		0.13	0.18	0.25	0.36	0.50	0.70	0.97	1.32
3		0.15	0.22	0.31	0.44	0.62	0.86	1.20	1.66
4		0.18	0.25	0.36	0.50	0.71	1.00	1.39	1.94
5		0.20	0.28	0.40	0.56	0.80	1.12	1.56	2.18
6		0.22	0.31	0.44	0.62	0.87	1.22	1.71	2.40
8		0.25	0.36	0.51	0.71	1.01	1.41	1.98	2.78
10		0.28	0.40	0.57	0.80	1.13	1.58	2.22	3.12
12		0.31	0.44	0.62	0.88	1.24	1.73	2.44	3.43
14		0.33	0.47	0.67	0.95	1.34	1.87	2.63	3.71
16		0.36	0.51	0.72	1.01	1.43	2.00	2.82	3.97
18		0.38	0.54	0.76	1.07	1.52	2.13	2.99	4.21
20		0.40	0.57	0.80	1.13	1.60	2.24	3.15	4.44
22		0.42	0.59	0.84	1.19	1.68	2.35	3.31	4.66
25		0.45	0.63	0.89	1.26	1.79	2.51	3.53	4.97
28	0.47	0.67	0.95	1.34	1.89	2.65	3.73	5.27	

Line offset dimensions shown are Metric (mm) only

SOLID HM MILLS – CORRECTION FACTORS

3c

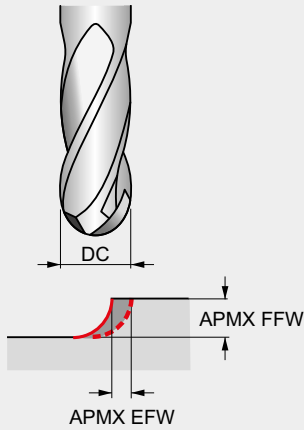

How to use this table to find the correction factor for the feed per tooth (f_z or IPT) for plain copy milling:

1. Find the closest radial immersion (APMX EFW / DC) for your cutting application in the top row of the table.
3. Find your closest axial immersion (APMX FFW / DC) for your cutting application in the left column of the table.
4. The intersection (cell) of the radial and axial immersions is the correction factor for the feed per tooth.

Example for plain copy milling:

1. Applying an 8 mm ball nose cutter with a depth of cut of 0.8 mm (APMX FFW), the aim is to achieve a theoretical surface roughness of 32 μm .
2. The correction factor for cutting speed with an axial immersion of 10% = 1.67 can be found in table 3a.
3. The step-over distance for a R_{th} of 32 μm = 1.01 mm can be found in table 3b.
4. The correction factor for feed per tooth with an axial immersion of 10% and a radial immersion of 1.01 / 8 = 12.6% can be found in table 3c and is in this case 2.33.

APMX FFW	APMX EFW	5 %	10 %	15 %	20 %	25 %	30 %	35 %	40 %	50 %
5%	$\times f$ 	5.26	3.82	3.21	2.87	2.65	2.50	2.40	2.34	2.29
10%		3.82	2.78	2.33	2.08	1.92	1.82	1.75	1.70	1.67
15%		3.21	2.33	1.96	1.75	1.62	1.53	1.47	1.43	1.40
20%		2.87	2.08	1.75	1.56	1.44	1.36	1.31	1.28	1.25
25%		2.65	1.92	1.62	1.44	1.33	1.26	1.21	1.18	1.15
30%		2.50	1.82	1.53	1.36	1.26	1.19	1.14	1.11	1.09
35%		2.40	1.75	1.47	1.31	1.21	1.14	1.10	1.07	1.05
40%		2.34	1.70	1.43	1.28	1.18	1.11	1.07	1.04	1.02
45%		2.31	1.68	1.41	1.26	1.16	1.10	1.05	1.03	1.01
50%		2.29	1.67	1.40	1.25	1.15	1.09	1.05	1.02	1.00

To increase the surface quality, the tool or surface should be included with a tilt angle off 10°– 15°.



SOLID HM BARREL-SHAPE MILL – FEED PER TOOTH TABLE

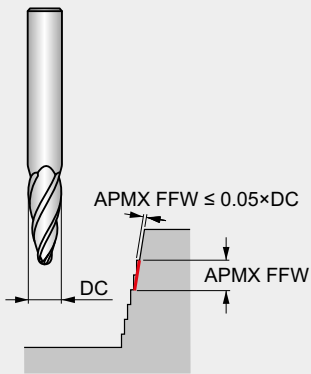

Feed per tooth (f_z in mm/rev) depended on the working conditions it might be needed to adjust these values $\pm 25\%$.

How to use this table to find the feed per tooth (f_z):

1. Find your Alpha Code on the product page (example: 121F, "F" is the Alpha Code).
2. Find the closest diameter for your cutting application in the top row of the table.
3. Find your Alpha Code in the left column of the table.
4. The intersection (cell) of the Diameter and Alpha Code is the feed per tooth (f_z).

**FOR HM S791
BARREL-SHAPE MILLS ONLY**

		\varnothing DC [mm]				
		6.00	8.00	10.00	12.00	16.00
Feed rates	E	0.030	0.039	0.053	0.067	0.096
	F	0.037	0.050	0.064	0.083	0.118
	I	0.062	0.084	0.111	0.141	0.203



HSS-E-PM, HSS-E, HSS MILLS



SOLID HSS MILLS – TOOL MATERIALS NAVIGATOR



Tool materials

High Speed Steel	HSS	A medium-alloyed high speed steel that has good machinability and good performance. HSS exhibits hardness, toughness and wear resistance characteristics that make it attractive in a wide range of applications, for example in drills and taps.
Cobalt High Speed Steel	HSS-E	This high speed steel contains cobalt for increased hot hardness. The composition of HSCo is a good combination of toughness and hardness. It has good machinability and good wear resistance, which makes it usable for drills, taps, milling cutters and reamers.
Cobalt Powder Metallurgy Steel	HSS-E PM	Sintered Cobalt High Speed Steel (HSCo powder metal) is a substrate produced using powder metallurgy technology. Tools using substrates produced by this method exhibit superior toughness and grindability.





SOLID HSS MILLS – SURFACE TREATMENTS AND COATINGS NAVIGATOR

Surface Treatments

Bright (uncoated)		Bright finish (uncoated surface) improves chip flow in soft or non-ferrous materials and maintains sharp cutting edges in abrasive materials.
Steam Tempering		Steam tempering gives a strongly adhering blue oxide surface that acts to retain cutting fluid and prevent chip to tool welding, thereby counteracting the formation of a built-up edge. Steam tempering can be applied to any bright tool but is most effective on drills and taps.

Surface Coatings

Alcrona Coating (Alcrona)		The Alcrona (AlCrN) family of coatings are aluminium chromium nitride coatings mostly used for milling cutters. The two unique properties of these coatings are high hot hardness and high oxidation resistance. When used on tools for machining applications involving heavy mechanical and thermal stresses, these properties translate into superior wear resistance. Multiple levels or specific versions of these coatings are available and specific for various tools and applications.
Titanium Carbon Nitride Coating (TiCN)		Titanium Carbon Nitride is a ceramic coating applied by PVD coating technology. TiCN is harder than TiN and has a lower coefficient of friction. Its hardness and toughness in combination with good wear resistance ensures that it finds its principal application in the field of milling to enhance the performance of milling cutters.



Material code (BMC)	HSS-E PM	HSS-E PM	HSS-E PM	HSS-E PM	HSS-E	HSS-E PM	HSS-E PM	HSS-E PM	HSS-E PM	HSS-E PM	HSS-E	HSS-E PM	HSS-E
Mill Profile	N	N	N	N	N	N	N	N	N	N	W	W	N
Number of flutes (NOF)	NOF 2	NOF 2	NOF 2	NOF 2	NOF 2	NOF 3	NOF 3	NOF 3	NOF 3	NOF 3	NOF 2	NOF 3	NOF 2
Cut length													
Flute Helix (FHA)	λ 30°	λ 30°	λ 30°	λ 30°	λ 30°	λ 30°	λ 30°	λ 40°	λ 30°	λ 30°	λ 40°	λ 40°	λ 30°
Radial rake angle (GAMF)	γ 12°	γ 12°	γ 12°	γ 12°	γ 12°	γ 12°	γ 12°	γ 15°	γ 12°	γ 12°	γ 20°	γ 25°	γ 12°
Shank	 DIN 1835B	 DIN 1835B	 DIN 1835B	 DIN 1835B	 DIN 1835B	 DIN 1835B	 DIN 1835B	 DIN 1835B	 DIN 1835B	 DIN 1835B	 DIN 1835B	 DIN 1835B	 DIN 1835A
Coating	Bright	TiCN	Bright	TiCN	Bright	Bright	Alcrona	Alcrona	Bright	Alcrona	Bright	Bright	Bright
Cutting diameter tolerance class (TDC)	DC e8	DC e8	DC e8	DC e8	DC e8	DC e8	DC e8	DC e8	DC e8	DC e8	DC e8	DC k10	DC js14
Direction													
Basic standard group (BSG)	DIN 327D	DIN 327D	DIN 844K	DIN 844K	DORMER	DIN 327D	DIN 327D	DIN 327D	DIN 844K	DIN 844K	DIN 844K	DIN 844K	DORMER
Product Family Code	C110	C126	C123	C139	C135	C306	C353	C367	C305	C352	C159	C336	C167
	1.00 - 40.00	1.00 - 30.00	1/16 - 30.00	2.00 - 25.00	2.00 - 20.00	3.00 - 30.00	3.00 - 30.00	2.00 - 20.00	2.00 - 32.00	3.00 - 20.00	2.00 - 20.00	10.00 - 30.00	6.00 - 16.00
	126	128	130	132	133	134	135	137	138	140	141	142	143
P	P1	■	■	■	■	■	■	■	■	■	■	■	■
	P2	■	■	■	■	■	■	■	■	■	■	■	■
	P3	■	■	■	■	■	■	■	■	■	■	■	■
	P4	■	■	■	■	■	■	■	■	■	■	■	■
M	M1	■	■	■	■	■	■	■	■	■	■	■	■
	M2	■	■	■	■	■	■	■	■	■	■	■	■
	M3	■	■	■	■	■	■	■	■	■	■	■	■
	M4	■	■	■	■	■	■	■	■	■	■	■	■
K	K1	■	■	■	■	■	■	■	■	■	■	■	■
	K2	■	■	■	■	■	■	■	■	■	■	■	■
	K3	■	■	■	■	■	■	■	■	■	■	■	■
	K4	■	■	■	■	■	■	■	■	■	■	■	■
	K5	■	■	■	■	■	■	■	■	■	■	■	■
N	N1	■	■	■	■	■	■	■	■	■	■	■	■
	N2	■	■	■	■	■	■	■	■	■	■	■	■
	N3	■	■	■	■	■	■	■	■	■	■	■	■
	N4	■	■	■	■	■	■	■	■	■	■	■	■
	N5	■	■	■	■	■	■	■	■	■	■	■	■
S	S1	■	■	■	■	■	■	■	■	■	■	■	■
	S2	■	■	■	■	■	■	■	■	■	■	■	■
	S3	■	■	■	■	■	■	■	■	■	■	■	■
	S4	■	■	■	■	■	■	■	■	■	■	■	■
H	H1												
	H2												
	H3												
	H4												

■ Primary use ■ Possible use



	HSS-E	HSS-E	HSS-E PM	HSS-E PM	HSS-E PM	HSS-E PM	HSS-E PM	HSS-E PM	HSS-E PM	HSS-E PM	HSS-E PM	HSS-E PM	HSS-E PM	HSS-E PM	
	N	N	N	N	N	N	N	N	N	W	HRA	HRA	HRA	NRA	NRA
	NOF 2	NOF 3	NOF 3-4	NOF 3-6	NOF 3-5	NOF 4-8	NOF 4-5	NOF 4-6	NOF 4-6	NOF 3	NOF 3-4	NOF 4-6	NOF 3-6	NOF 4	NOF 4-6
	λ 30°	λ 30°	λ 45°	λ 45°	λ 45°	λ 30°	λ 30°	λ 30°	λ 30°	λ 40°	λ 35°	λ 35°	λ 35°	λ 35°	λ 35°
	γ 12°	γ 12°	γ 12°	γ 12°	γ 12°	γ 12°	γ 12°	γ 12°	γ 12°	γ 25°	γ 12°	γ 12°	γ 12°	γ 12°	γ 12°
	Bright	Bright	Bright	Alcrona	Alcrona	Bright	TiCN	Bright	TiCN	Bright	Alcrona	Alcrona	Alcrona	Bright	Alcrona
	DC e8	DC e8	DC k10	DC k10	DC k10	DC k10	DC k10	DC k10	DC k10	DC k10	DC k12	DC k12	DC k12	DC k12	DC k12
	DORMER	DIN 844L	DIN 844K	DIN 844K	DIN 844L	DIN 844K	DIN 844K	DIN 844L	DIN 844L	DIN 844L	DIN 844K	DIN 844K	DIN 844L	DIN 844K	DIN 844K
	C122	C346	C299	C907	C920	C247	C246	C273	C295	C333	C922	C428	C492	C407	C908
	5.00 - 22.00	3.00 - 20.00	3.00 - 20.00	3.00 - 32.00	6.00 - 25.00	2.00 - 50.00	2.00 - 25.00	2.00 - 40.00	2.00 - 40.00	10.00 - 30.00	6.00 - 32.00	6.00 - 40.00	6.00 - 30.00	6.00 - 20.00	6.00 - 32.00
	144	145	146	147	148	149	151	152	154	155	156	157	158	159	160
P1	■	■	■	■	■	■	■	■	■	■	■	■	■	■	■
P2	■	■	■	■	■	■	■	■	■	■	■	■	■	■	■
P3	■	■	■	■	■	■	■	■	■	■	■	■	■	■	■
P4	■	■	■	■	■	■	■	■	■	■	■	■	■	■	■
M1	■	■	■	■	■	■	■	■	■	■	■	■	■	■	■
M2	■	■	■	■	■	■	■	■	■	■	■	■	■	■	■
M3	■	■	■	■	■	■	■	■	■	■	■	■	■	■	■
M4	■	■	■	■	■	■	■	■	■	■	■	■	■	■	■
K1	■	■	■	■	■	■	■	■	■	■	■	■	■	■	■
K2	■	■	■	■	■	■	■	■	■	■	■	■	■	■	■
K3	■	■	■	■	■	■	■	■	■	■	■	■	■	■	■
K4	■	■	■	■	■	■	■	■	■	■	■	■	■	■	■
K5	■	■	■	■	■	■	■	■	■	■	■	■	■	■	■
N1	■	■	■	■	■	■	■	■	■	■	■	■	■	■	■
N2	■	■	■	■	■	■	■	■	■	■	■	■	■	■	■
N3	■	■	■	■	■	■	■	■	■	■	■	■	■	■	■
N4	■	■	■	■	■	■	■	■	■	■	■	■	■	■	■
N5	■	■	■	■	■	■	■	■	■	■	■	■	■	■	■
S1	■	■	■	■	■	■	■	■	■	■	■	■	■	■	■
S2	■	■	■	■	■	■	■	■	■	■	■	■	■	■	■
S3	■	■	■	■	■	■	■	■	■	■	■	■	■	■	■
S4	■	■	■	■	■	■	■	■	■	■	■	■	■	■	■
H1	■	■	■	■	■	■	■	■	■	■	■	■	■	■	■
H2	■	■	■	■	■	■	■	■	■	■	■	■	■	■	■
H3	■	■	■	■	■	■	■	■	■	■	■	■	■	■	■
H4	■	■	■	■	■	■	■	■	■	■	■	■	■	■	■

■ Primary use ■ Possible use



Material code (BMC)	HSS-E PM	HSS-E	HSS-E	HSS-E	HSS-E	HSS-E	HSS-E	HSS	HSS-E	HSS-E	HSS	HSS	HSS-E
Mill Profile	NRA	NF	NF	NF	N	N	N	N	N	NF	N	N	N
Number of flutes (NOF)	NOF 4-6	NOF 4	NOF 4	NOF 4-6	NOF 2	NOF 2	NOF 6-8	NOF 6-8	NOF 8-12	NOF 6-8	NOF 6-8	NOF 6-8	NOF 10-12
Cut length													
Flute Helix (FHA)	λ 35°	λ 30°	λ 30°	λ 30°	λ 30°	λ 30°	λ 15°	λ 12°	λ 15°	λ 12°	λ 0°	λ 0°	λ 0°
Radial rake angle (GAMF)	γ 12°	γ 12°	γ 12°	γ 12°	γ 12°	γ 12°	γ 10°	γ 10°	γ 15°	γ 10°	γ 0°	γ 0°	γ 0°
Shank	 DIN 1835B	 DIN 1835B	 DIN 1835B	 DIN 1835B	 DIN 1835B	 DIN 1835B	 DIN 1835	 DIN 1835D	 DIN 1835B	 DIN 1835B	 DIN 1835D	 DIN 1835D	 DIN 1835B
Coating	 Alcona	 Bright	 TiCN	 Bright	 Bright	 Bright	 Bright	 Bright	 Bright	 Bright	 Bright	 Bright	 Bright
Cutting diameter tolerance class (TDC)	DC k12	DC k12	DC k12	DC k12	DC e8	DC e8	DC d11	DC d11	DC js16	DC d11			DC js16
Direction													
Basic standard group (BSG)	DIN 844L	DIN 844K	DIN 844K	DIN 844L	DIN 327D	DIN 844K	DIN 851	DORMER	DORMER	DIN 851	DORMER	DORMER	DIN 1833C
Product Family Code													
	C948	C400	C413	C403	C500	C505	C800	C810	C825	C801	C837	C835	C830
	6.00 - 32.00	6.00 - 20.00	6.00 - 20.00	10.00 - 50.00	2.00 - 25.00	3.00 - 30.00	11.00 - 50.00	12.50 - 40.00	40.00 - 63.00	16.00 - 32.00	13.00 - 38.00	1/2 - 1.1/2	12.00 - 32.00
	161	162	163	164	165	166	167	168	169	170	171	172	173
P	P1	■	■	■	■	■	■	■	■	■	■	■	■
	P2	■	■	■	■	■	■	■	■	■	■	■	■
	P3	■	■	■	■	■	■	■	■	■	■	■	■
	P4	■	■	■	■	■	■	■	■	■	■	■	■
M	M1	■	■	■	■	■	■	■	■	■	■	■	■
	M2	■	■	■	■	■	■	■	■	■	■	■	■
	M3	■	■	■	■	■	■	■	■	■	■	■	■
	M4	■	■	■	■	■	■	■	■	■	■	■	■
K	K1	■	■	■	■	■	■	■	■	■	■	■	■
	K2	■	■	■	■	■	■	■	■	■	■	■	■
	K3	■	■	■	■	■	■	■	■	■	■	■	■
	K4	■	■	■	■	■	■	■	■	■	■	■	■
	K5	■	■	■	■	■	■	■	■	■	■	■	■
N	N1	■	■	■	■	■	■	■	■	■	■	■	■
	N2	■	■	■	■	■	■	■	■	■	■	■	■
	N3	■	■	■	■	■	■	■	■	■	■	■	■
	N4	■	■	■	■	■	■	■	■	■	■	■	■
	N5	■	■	■	■	■	■	■	■	■	■	■	■
S	S1	■	■	■	■	■	■	■	■	■	■	■	■
	S2	■	■	■	■	■	■	■	■	■	■	■	■
	S3	■	■	■	■	■	■	■	■	■	■	■	■
	S4	■	■	■	■	■	■	■	■	■	■	■	■
H	H1												
	H2												
	H3												
	H4												

■ Primary use ■ Possible use



	HSS-E	HSS	HSS-E	HSS-E	HSS	HSS-E	HSS-E	HSS	HSS
	N	N	N	N	N	N			
	NOF 10-12	NOF 4	NOF 4-6	NOF 6-12	NOF 6-12	NOF 16-24	28-44 NOF	32-100 NOF	48-200 NOF
	λ 0°	λ 0°	λ 0°	λ 10°	λ 12°	λ 15°	λ 15°		
	γ 0°	γ 0°	γ 0°	γ 10°	γ 10°	γ 10°	γ 10°	γ 15°	γ 5°
	Bright	Bright	Bright	Bright	Bright	Bright	Bright	Bright	Bright
	DC js16			DC h11		DC js16	DC js16		
	DIN 1833D	BS 122/4	DORMER	DIN 850	DORMER	DIN 885A	DIN 885A	DIN 1838	DIN 1837
	C831	C710	C700	C822	C820	D200	D763	D745	D747
	12.00 - 32.00	1/16 - 1/2	1.00 - 20.00	4.50 - 45.50	10.50 - 45.50	50.00 - 125.00	63.00 - 125.00	50.00 - 250.00	32.00 - 200.00
	174	175	176	177	178	180	181	182	184
P1	■	■	■	■	■	■	■	■	■
P2	■	■	■	■	■	■	■	■	■
P3	■	■	■	■	■	■	■	■	■
P4	■	▣	■	■	▣	■	■	■	■
M1	■	■	■	■	■	■	■	▣	▣
M2	■	■	■	■	■	■	■	▣	▣
M3	■	■	■	■	■	■	■	▣	▣
M4	■	▣	■	■	▣	■	■	■	■
K1	■	■	■	■	■	■	■	■	■
K2	■	■	■	■	■	■	■	■	■
K3	■	■	■	■	■	■	■	■	■
K4	■	■	■	■	■	■	■	■	■
K5	■	■	■	■	■	■	■	■	■
N1	■	■	■	■	■	■	■	■	■
N2	■	■	■	■	■	■	■	■	■
N3	■	■	■	■	■	■	■	■	■
N4	■	■	■	■	▣	■	■	■	■
N5	■	■	■	■	■	■	■	■	■
S1	■	■	■	■	▣	■	■	■	■
S2	■	▣	■	■	▣	■	■	■	■
S3	■	▣	■	■	▣	■	■	■	■
S4	■	▣	■	■	▣	■	■	■	■
H1									
H2									
H3									
H4									

■ Primary use ▣ Possible use



		HSS	HSS	HSS	HSS	HSS-E	HSS-E
Material code (BMC)		HSS	HSS	HSS	HSS	HSS-E	HSS-E
Mill Profile						N	N
Number of flutes (NOF)		110-180 NOF	100-140 NOF	130-220 NOF	160-350 NOF	NOF 8	NOF 8
Cut length							
Flute Helix (FHA)						λ 30°	λ 30°
Radial rake angle (GAMF)		γ 18°	γ 18°	γ 18°	γ 18°	γ 12°	γ 12°
Shank							
Coating		ST	ST	ST	ST	Bright	TCN
Cutting diameter tolerance class (TCDC)						DC js16	DC js16
Direction							
Basic standard group (BSG)		DORMER	DORMER	DORMER	DORMER	DIN 1880	DIN 1880
Product Family Code		D752	D753	D750	D751	D400	D420
		250.00 - 350.00	250.00 - 350.00	200.00 - 350.00	200.00 - 350.00	40.00 - 63.00	40.00 - 63.00
		186	187	188	189	190	191
P	P1	■	■	■	■	■	■
	P2	■	■	■	■	■	■
	P3	■	■	■	■	■	■
	P4	■	■	■	■	▣	■
M	M1	▣	▣	▣	▣	■	■
	M2	▣	▣	▣	▣	■	■
	M3	▣	▣	▣	▣	▣	■
	M4					■	■
K	K1	■	■	■	■	■	■
	K2	■	■	■	■	■	■
	K3	■	■	■	■	■	■
	K4	■	■	■	■	■	■
	K5	■	■	■	■	■	■
N	N1	■	■	■	■	▣	▣
	N2	■	■	■	■	■	■
	N3	■	■	■	■	■	■
	N4	■	■	■	■	▣	▣
	N5						
S	S1					▣	■
	S2					▣	■
	S3					▣	■
	S4					▣	■
H	H1						
	H2						
	H3						
	H4						

■ Primary use ▣ Possible use

HSS-E

NR

NOF
6-8

λ
30°

γ
12°

Bright

DC
js16

DIN
1880

HSS-E

NR

NOF
6-8

λ
30°

γ
12°

TiCN

DC
js16

DIN
1880



D402

D422

40.00 - 63.00

40.00 - 63.00

192

193

	D402	D422							
P1	■	■							
P2	■	■							
P3	■	■							
P4	☑	■							
M1	■	■							
M2	■	■							
M3	☑	■							
M4	■	■							
K1	■	■							
K2	■	■							
K3	■	■							
K4	■	■							
K5	■	■							
N1	☑	☑							
N2	■	■							
N3	■	■							
N4	☑	☑							
N5									
S1	☑	■							
S2	☑	■							
S3	☑	■							
S4	☑	■							
H1									
H2									
H3									
H4									



C110



2-Flute HSS-E-PM Slot End Mill, Bright Finish

Extra short cut length, 2-flute design provides high rigidity. Suitable for milling shallow slots and ramping. The accurate diameter means the tools are designed for milling standard keyway slots to a P9 tolerance. Versatile and can be used in mild steels, non-ferrous materials and medium strength titanium alloys.

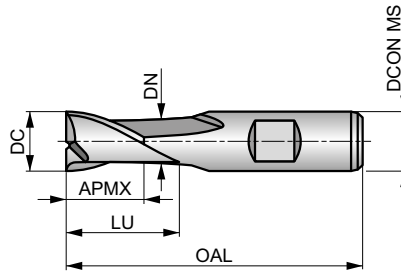

HSS-E PM	N	NOF 2
	λ 30°	γ 12°
DIN 1835B	Bright	DC e8
	DIN 327D	



Workpiece material group suitability, starting values for cutting speed (m/min) and Alpha Code. Tables with feed per tooth and correction factors can be found starting from page 194.

P1.1 ■ 53 E	P1.2 ■ 59 E	P1.3 ■ 61 E	P2.1 ■ 45 E	P2.2 ■ 40 E	P3.1 ■ 37 E	P3.2 ■ 30 D	P4.1 ■ 22 D	M1.1 ■ 41 E	M1.2 ■ 35 E	M2.1 ■ 37 E	M2.2 ■ 30 D	K1.1 ■ 35 E	K1.2 ■ 26 E
K1.3 ■ 19 E	K2.1 ■ 62 E	K2.2 ■ 50 E	K2.3 ■ 40 D	K3.1 ■ 54 E	K3.2 ■ 42 E	K3.3 ■ 34 D	K4.1 ■ 50 D	K4.2 ■ 38 D	K4.3 ■ 28 D	K4.4 ■ 24 C	K4.5 ■ 20 C	K5.1 ■ 57 D	K5.2 ■ 43 D
K5.3 ■ 33 D	N1.1 ■ 95 G	N1.2 ■ 71 F	N1.3 ■ 48 F	N2.1 ■ 48 E	N2.2 ■ 43 E	N2.3 ■ 31 E	N3.1 ■ 50 E	N3.2 ■ 29 E	N3.3 ■ 15 E	N4.1 ■ 50 E	S1.1 ■ 35 D	S1.2 ■ 25 D	S2.1 ■ 20 C
S3.1 ■ 15 C	S4.1 ■ 12 C												

DCON MS tolerance h6.

Product	DC [inch]	DC [mm]	DCON MS [mm]	APMX [mm]	OAL [mm]	NOF	LU [mm]	DN [mm]
C1101.0	–	1.00	6.00	2.50	47.0	2	–	–
C1101.5	–	1.50	6.00	3.00	47.0	2	–	–
C1101/16	1/16	1.59	6.00	3.00	47.0	2	–	–
C1101.8	–	1.80	6.00	4.00	48.0	2	–	–
C1102.0	–	2.00	6.00	4.00	48.0	2	–	–
C1103/32	3/32	2.38	6.00	5.00	49.0	2	–	–
C1102.5	–	2.50	6.00	5.00	49.0	2	–	–
C1102.8	–	2.80	6.00	5.00	49.0	2	–	–
C1103.0	–	3.00	6.00	5.00	49.0	2	–	–
C1101/8	1/8	3.18	6.00	6.00	50.0	2	–	–
C1103.5	–	3.50	6.00	6.00	50.0	2	–	–
C1103.8	–	3.80	6.00	7.00	51.0	2	–	–
C1104.0	–	4.00	6.00	7.00	51.0	2	–	–
C1104.5	–	4.50	6.00	7.00	51.0	2	–	–
C1103/16	3/16	4.76	6.00	8.00	52.0	2	–	–
C1104.8 ²⁾	–	4.80	6.00	8.00	52.0	2	–	–
C1105.0	–	5.00	6.00	8.00	52.0	2	–	–
C1105.5	–	5.50	6.00	8.00	52.0	2	–	–
C1105.75 ²⁾	–	5.75	6.00	8.00	52.0	2	–	–
C1106.0	–	6.00	6.00	8.00	52.0	2	–	–
C1101/4	1/4	6.35	10.00	10.00	60.0	2	–	–
C1106.5	–	6.50	10.00	10.00	60.0	2	–	–
C1107.0	–	7.00	10.00	10.00	60.0	2	–	–
C1107.5	–	7.50	10.00	10.00	60.0	2	–	–
C1107.75 ²⁾	–	7.75	10.00	11.00	61.0	2	–	–



Product	DC	DC	DCON MS	APMX	OAL	NOF	LU	DN
	[inch]	[mm]	[mm]	[mm]	[mm]		[mm]	[mm]
C1105/16	5/16	7.94	10.00	11.00	61.0	2	–	–
C1108.0	–	8.00	10.00	11.00	61.0	2	–	–
C1108.5	–	8.50	10.00	11.00	61.0	2	–	–
C1109.0	–	9.00	10.00	11.00	61.0	2	–	–
C1109.5	–	9.50	10.00	11.00	61.0	2	–	–
C1103/8	3/8	9.52	10.00	13.00	63.0	2	22.50	9.50
C11010.0	–	10.00	10.00	13.00	63.0	2	22.50	9.50
C11013/32	13/32	10.32	12.00	13.00	70.0	2	–	–
C11010.5	–	10.50	12.00	13.00	70.0	2	–	–
C11011.0	–	11.00	12.00	13.00	70.0	2	–	–
C1107/16	7/16	11.11	12.00	13.00	70.0	2	–	–
C11011.5	–	11.50	12.00	13.00	70.0	2	–	–
C11012.0	–	12.00	12.00	16.00	73.0	2	27.50	11.50
C11012.5	–	12.50	12.00	16.00	73.0	2	27.50	11.50
C1101/2	1/2	12.70	12.00	16.00	73.0	2	27.50	11.50
C11013.0	–	13.00	12.00	16.00	73.0	2	27.50	11.50
C11017/32	17/32	13.49	12.00	16.00	73.0	2	27.50	11.50
C11014.0	–	14.00	12.00	16.00	73.0	2	27.50	11.50
C1109/16	9/16	14.29	12.00	16.00	73.0	2	27.50	11.50
C11015.0	–	15.00	12.00	16.00	73.0	2	27.50	11.50
C1105/8	5/8	15.88	16.00	19.00	79.0	2	30.50	15.50
C11016.0	–	16.00	16.00	19.00	79.0	2	30.50	15.50
C11017.0	–	17.00	16.00	19.00	79.0	2	30.50	15.50
C11011/16	11/16	17.46	16.00	19.00	79.0	2	30.50	15.50
C11018.0	–	18.00	16.00	19.00	79.0	2	30.50	15.50
C11019.0	–	19.00	16.00	19.00	79.0	2	30.50	15.50
C1103/4	3/4	19.05	20.00	22.00	88.0	2	37.50	18.50
C11020.0	–	20.00	20.00	22.00	88.0	2	37.50	19.50
C11022.0	–	22.00	20.00	22.00	88.0	2	37.50	19.50
C1107/8	7/8	22.22	20.00	22.00	88.0	2	37.50	19.50
C11024.0	–	24.00	25.00	26.00	102.0	2	45.50	23.50
C11025.0	–	25.00	25.00	26.00	102.0	2	45.50	24.50
C1101	1"	25.40	25.00	26.00	102.0	2	45.50	24.50
C11026.0	–	26.00	25.00	26.00	102.0	2	45.50	24.50
C11028.0	–	28.00	25.00	26.00	102.0	2	45.50	24.50
C11030.0	–	30.00	25.00	26.00	102.0	2	45.50	24.50
C11032.0	–	32.00	32.00	32.00	112.0	2	51.50	31.50
C11035.0 ¹⁾	–	35.00	32.00	32.00	112.0	2	51.50	31.50
C11036.0 ¹⁾	–	36.00	32.00	32.00	112.0	2	51.50	31.50
C11040.0 ¹⁾	–	40.00	40.00	38.00	130.0	2	59.50	39.00

¹⁾ DC tolerance h10; available in HSS-E only.

²⁾ DC tolerance h10; slot not in P9 tolerance.



C126



2-Flute HSS-E-PM Slot End Mill, TiCN Coating

Extra short cut length, 2-flute design provides high rigidity. Suitable for milling shallow slots and ramping. The accurate diameter means the tools are designed for milling standard keyway slots to a P9 tolerance. TiCN coating increases the tool life and improves performance when milling hard and abrasive materials.

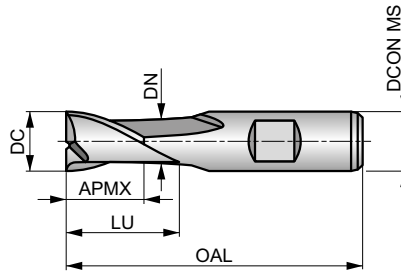

HSS-E PM	N	NOF 2
	λ 30°	γ 12°
DIN 1835B	TiCN	DC e8
	DIN 327D	



Workpiece material group suitability, starting values for cutting speed (m/min) and Alpha Code. Tables with feed per tooth and correction factors can be found starting from page 194.

P1.1 ■ 126 E	P1.2 ■ 141 E	P1.3 ■ 146 E	P2.1 ■ 108 E	P2.2 ■ 95 E	P2.3 ▧ 184 D	P3.1 ■ 81 E	P3.2 ■ 65 D	P3.3 ▧ 155 D	P4.1 ■ 48 D	P4.2 ▧ 41 D	P4.3 ▧ 34 D	M1.1 ▧ 62 E	M1.2 ▧ 52 E
M2.1 ▧ 55 E	M2.2 ▧ 45 D	M3.3 ▧ 26 C	M4.1 ▧ 25 C	K1.1 ■ 60 E	K1.2 ■ 44 E	K1.3 ■ 33 E	K2.1 ■ 111 E	K2.2 ■ 90 E	K2.3 ■ 72 D	K3.1 ■ 98 E	K3.2 ■ 75 E	K3.3 ■ 61 D	K4.1 ■ 91 D
K4.2 ■ 68 D	K4.3 ■ 50 D	K4.4 ■ 43 C	K4.5 ■ 36 C	K5.1 ■ 103 D	K5.2 ■ 77 D	K5.3 ■ 60 D	N1.1 ▧ 177 G	N1.2 ▧ 133 F	N1.3 ▧ 89 F	N2.1 ▧ 89 E	N2.2 ■ 80 E	N2.3 ■ 57 E	N3.1 ■ 93 E
N3.2 ■ 55 E	N3.3 ■ 28 E	N4.1 ▧ 93 E	S1.1 ■ 45 D	S1.2 ■ 40 D	S1.3 ▧ 15 C	S2.1 ■ 33 C	S2.2 ▧ 14 C	S3.1 ■ 25 C	S3.2 ▧ 10 C	S4.1 ■ 20 C	S4.2 ▧ 8 C		

DCON MS tolerance h6.

Product	DC [mm]	DCON MS [mm]	APMX [mm]	OAL [mm]	NOF	LU [mm]	DN [mm]
C1261.0	1.00	6.00	2.50	47.0	2	-	-
C1261.5	1.50	6.00	3.00	47.0	2	-	-
C1262.0	2.00	6.00	4.00	48.0	2	-	-
C1262.5	2.50	6.00	5.00	49.0	2	-	-
C1263.0	3.00	6.00	5.00	49.0	2	-	-
C1263.5	3.50	6.00	6.00	50.0	2	-	-
C1264.0	4.00	6.00	7.00	51.0	2	-	-
C1264.5	4.50	6.00	7.00	51.0	2	-	-
C1265.0	5.00	6.00	8.00	52.0	2	-	-
C1265.5	5.50	6.00	8.00	52.0	2	-	-
C1266.0	6.00	6.00	8.00	52.0	2	-	-
C1266.5	6.50	10.00	10.00	60.0	2	-	-
C1267.0	7.00	10.00	10.00	60.0	2	-	-
C1267.5	7.50	10.00	10.00	60.0	2	-	-
C1268.0	8.00	10.00	11.00	61.0	2	-	-
C1268.5	8.50	10.00	11.00	61.0	2	-	-
C1269.0	9.00	10.00	11.00	61.0	2	-	-
C1269.5	9.50	10.00	11.00	61.0	2	-	-
C12610.0	10.00	10.00	13.00	63.0	2	22.50	9.50
C12610.5	10.50	12.00	13.00	70.0	2	-	-
C12611.0	11.00	12.00	13.00	70.0	2	-	-
C12611.5	11.50	12.00	13.00	70.0	2	-	-
C12612.0	12.00	12.00	16.00	73.0	2	27.50	11.50
C12612.5	12.50	12.00	16.00	73.0	2	27.50	11.50
C12613.0	13.00	12.00	16.00	73.0	2	27.50	11.50



Product	DC	DCON MS	APMX	OAL	NOF	LU	DN
	[mm]	[mm]	[mm]	[mm]		[mm]	[mm]
C12614.0	14.00	12.00	16.00	73.0	2	27.50	11.50
C12615.0	15.00	12.00	16.00	73.0	2	27.50	11.50
C12616.0	16.00	16.00	19.00	79.0	2	30.50	15.50
C12618.0	18.00	16.00	19.00	79.0	2	30.50	15.50
C12620.0	20.00	20.00	22.00	88.0	2	37.50	19.50
C12622.0	22.00	20.00	22.00	88.0	2	37.50	19.50
C12624.0	24.00	25.00	26.00	102.0	2	45.50	23.50
C12625.0	25.00	25.00	26.00	102.0	2	45.50	24.50
C12630.0	30.00	25.00	26.00	102.0	2	45.50	24.50



C123



2-Flute HSS-E-PM Slot End Mill, Bright Finish

Short cut length, 2-flute design provides high rigidity. Suitable for milling shallow slots and ramping. The accurate diameter means the tools are designed for milling standard keyway slots to a P9 tolerance. Versatile and can be used in mild steels, non-ferrous materials and medium strength titanium alloys.

HSS-E PM	N	NOF 2
	λ 30°	γ 12°
	Bright	DC e8
	DIN 844K	

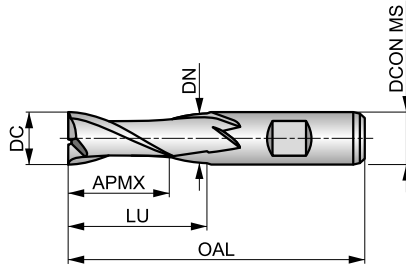

Workpiece material group suitability, starting values for cutting speed (m/min) and Alpha Code. Tables with feed per tooth and correction factors can be found starting from page 194.

P1.1 ■ 53 D	P1.2 ■ 59 D	P1.3 ■ 61 D	P2.1 ■ 45 D	P2.2 ■ 40 D	P3.1 ■ 37 D	P3.2 ■ 30 C	P4.1 ■ 22 C	M1.1 ■ 34 D	M1.2 ■ 29 D	M2.1 ■ 31 D	M2.2 ■ 25 C	K1.1 ■ 30 D	K1.2 ■ 22 D
K1.3 ■ 17 D	K2.1 ■ 55 D	K2.2 ■ 45 D	K2.3 ■ 36 C	K3.1 ■ 49 D	K3.2 ■ 37 D	K3.3 ■ 30 B	K4.1 ■ 45 C	K4.2 ■ 34 C	K4.3 ■ 25 C	K4.4 ■ 22 B	K4.5 ■ 18 B	K5.1 ■ 51 C	K5.2 ■ 39 C
K5.3 ■ 30 C	N1.1 ■ 95 F	N1.2 ■ 71 E	N1.3 ■ 48 E	N2.1 ■ 48 D	N2.2 ■ 43 D	N2.3 ■ 31 D	N3.1 ■ 50 D	N3.2 ■ 29 D	N3.3 ■ 15 D	N4.1 ■ 50 D	S1.1 ■ 30 C	S1.2 ■ 25 C	S2.1 ■ 20 B
S3.1 ■ 15 B	S4.1 ■ 12 B												

DCON MS tolerance h6.

Product	DC [inch]	DC [mm]	DCON MS [mm]	APMX [mm]	OAL [mm]	NOF	LU [mm]	DN [mm]
C1231/16 ¹⁾	1/16	1.59	6.00	7.00	51.0	2	–	–
C1232.0	–	2.00	6.00	7.00	51.0	2	–	–
C1232.5	–	2.50	6.00	8.00	52.0	2	–	–
C1233.0	–	3.00	6.00	8.00	52.0	2	–	–
C1231/8 ¹⁾	1/8	3.18	6.00	10.00	54.0	2	–	–
C1233.5	–	3.50	6.00	10.00	54.0	2	–	–
C1235/32 ¹⁾	5/32	3.97	6.00	11.00	55.0	2	–	–
C1234.0	–	4.00	6.00	11.00	55.0	2	–	–
C1234.5	–	4.50	6.00	11.00	55.0	2	–	–
C1233/16 ¹⁾	3/16	4.76	6.00	13.00	57.0	2	–	–
C1235.0	–	5.00	6.00	13.00	57.0	2	–	–
C1235.5	–	5.50	6.00	13.00	57.0	2	–	–
C1236.0	–	6.00	6.00	13.00	57.0	2	–	–
C1231/4 ¹⁾	1/4	6.35	10.00	16.00	66.0	2	–	–
C1236.5	–	6.50	10.00	16.00	66.0	2	–	–
C1237.0	–	7.00	10.00	16.00	66.0	2	–	–
C1237.5	–	7.50	10.00	16.00	66.0	2	–	–
C1235/16 ¹⁾	5/16	7.94	10.00	19.00	69.0	2	–	–
C1238.0	–	8.00	10.00	19.00	69.0	2	–	–
C1238.5	–	8.50	10.00	19.00	69.0	2	–	–
C1239.0	–	9.00	10.00	19.00	69.0	2	–	–
C1239.5	–	9.50	10.00	19.00	69.0	2	–	–
C1233/8 ¹⁾	3/8	9.52	10.00	22.00	72.0	2	31.50	9.50
C12310.0	–	10.00	10.00	22.00	72.0	2	31.50	9.50
C12311.0	–	11.00	12.00	22.00	79.0	2	–	–



Product	DC	DC	DCON MS	APMX	OAL	NOF	LU	DN
	[inch]	[mm]	[mm]	[mm]	[mm]		[mm]	[mm]
C12312.0	–	12.00	12.00	26.00	83.0	2	37.50	11.50
C1231/2¹⁾	1/2	12.70	12.00	26.00	83.0	2	37.50	11.50
C12313.0	–	13.00	12.00	26.00	83.0	2	37.50	11.50
C12314.0	–	14.00	12.00	26.00	83.0	2	37.50	11.50
C12315.0	–	15.00	12.00	26.00	83.0	2	37.50	11.50
C12316.0	–	16.00	16.00	32.00	92.0	2	43.50	15.50
C12318.0	–	18.00	16.00	32.00	92.0	2	43.50	15.50
C12320.0	–	20.00	20.00	38.00	104.0	2	53.50	19.50
C12322.0	–	22.00	20.00	38.00	104.0	2	53.50	19.50
C12325.0	–	25.00	25.00	45.00	121.0	2	64.50	24.50
C12330.0	–	30.00	25.00	45.00	121.0	2	64.50	24.50

¹⁾ DC tolerance -0.0005 inches / -0.0013 inches.



C139



2-Flute HSS-E-PM Slot End Mill, TiCN Coating

Short cut length, 2-flute design provides high rigidity. Suitable for milling shallow slots and ramping. The accurate diameter means the tools are designed for milling standard keyway slots to a P9 tolerance. TiCN coating increases the life of the cutter and improves performance when milling hard and abrasive materials.

HSS-E PM	N	NOF 2
	λ 30°	γ 12°
DIN 1835B	TiCN	DC e8
	DIN 844K	

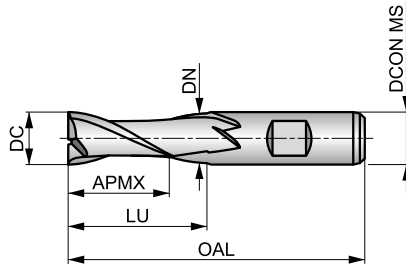

Workpiece material group suitability, starting values for cutting speed (m/min) and Alpha Code. Tables with feed per tooth and correction factors can be found starting from page 194.

P1.1 ■ 113 D	P1.2 ■ 126 D	P1.3 ■ 131 D	P2.1 ■ 97 D	P2.2 ■ 85 D	P2.3 ▣ 75 C	P3.1 ■ 74 D	P3.2 ■ 59 C	P3.3 ▣ 50 C	P4.1 ■ 44 C	P4.2 ▣ 37 C	P4.3 ▣ 31 C	M1.1 ▣ 62 D	M1.2 ▣ 52 D
M2.1 ▣ 55 D	M2.2 ▣ 45 C	M3.3 ▣ 26 B	M4.1 ▣ 25 B	K1.1 ■ 55 D	K1.2 ■ 41 D	K1.3 ■ 31 D	K2.1 ■ 98 D	K2.2 ■ 80 D	K2.3 ■ 64 C	K3.1 ■ 87 D	K3.2 ■ 67 D	K3.3 ■ 54 B	K4.1 ■ 81 C
K4.2 ■ 61 C	K4.3 ■ 45 C	K4.4 ■ 38 B	K4.5 ■ 32 B	K5.1 ■ 91 C	K5.2 ■ 69 C	K5.3 ■ 53 C	N1.1 ▣ 159 F	N1.2 ▣ 120 E	N1.3 ▣ 80 E	N2.1 ▣ 80 D	N2.2 ■ 72 D	N2.3 ■ 51 D	N3.1 ■ 84 D
N3.2 ■ 50 D	N3.3 ■ 25 D	N4.1 ▣ 84 D	S1.1 ■ 45 C	S1.2 ■ 35 C	S1.3 ▣ 15 B	S2.1 ■ 33 B	S2.2 ▣ 14 B	S3.1 ■ 25 B	S3.2 ▣ 10 B	S4.1 ■ 20 B	S4.2 ▣ 8 B		

DCON MS tolerance h6.

Product	DC [mm]	DCON MS [mm]	APMX [mm]	OAL [mm]	NOF	LU [mm]	DN [mm]
C1392.0	2.00	6.00	7.00	51.0	2	–	–
C1393.0	3.00	6.00	8.00	52.0	2	–	–
C1394.0	4.00	6.00	11.00	55.0	2	–	–
C1395.0	5.00	6.00	13.00	57.0	2	–	–
C1395.5	5.50	6.00	13.00	57.0	2	–	–
C1396.0	6.00	6.00	13.00	57.0	2	–	–
C1396.5	6.50	10.00	16.00	66.0	2	–	–
C1397.0	7.00	10.00	16.00	66.0	2	–	–
C1397.5	7.50	10.00	16.00	66.0	2	–	–
C1398.0	8.00	10.00	19.00	69.0	2	–	–
C1398.5	8.50	10.00	19.00	69.0	2	–	–
C1399.0	9.00	10.00	19.00	69.0	2	–	–
C1399.5	9.50	10.00	19.00	69.0	2	–	–
C13910.0	10.00	10.00	22.00	72.0	2	31.50	9.50
C13911.0	11.00	12.00	22.00	79.0	2	–	–
C13912.0	12.00	12.00	26.00	83.0	2	37.50	11.50
C13913.0	13.00	12.00	26.00	83.0	2	37.50	11.50
C13914.0	14.00	12.00	26.00	83.0	2	37.50	11.50
C13915.0	15.00	12.00	26.00	83.0	2	37.50	11.50
C13916.0	16.00	16.00	32.00	92.0	2	43.50	15.50
C13918.0	18.00	16.00	32.00	92.0	2	43.50	15.50
C13920.0	20.00	20.00	38.00	104.0	2	53.50	19.50
C13922.0	22.00	20.00	38.00	104.0	2	53.50	19.50
C13925.0	25.00	25.00	45.00	121.0	2	64.50	24.50



C135



2-Flute HSS-E Extra Long Reach Slot End Mill, Bright Finish

Short cut length, 2-flute design provides high rigidity for milling standard keyway slots to a P9 tolerance. Provides increased strength and reduced vibrations in difficult to reach areas. This can be used in mild steels and non-ferrous materials.

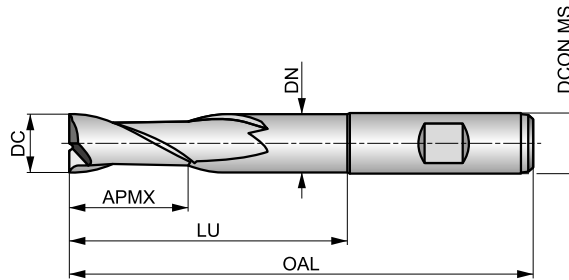

HSS-E	N	NOF 2
	λ 30°	γ 12°
DIN 1835B	Bright	DC e8



Workpiece material group suitability, starting values for cutting speed (m/min) and Alpha Code. Tables with feed per tooth and correction factors can be found starting from page 194.

P1.1 ■ 46 C	P1.2 ■ 52 C	P1.3 ■ 54 C	P2.1 ■ 40 C	P2.2 ■ 35 C	P3.1 ■ 32 C	P3.2 ■ 26 B	P4.1 ■ 19 B	M1.1 ■ 34 C	M1.2 ■ 29 C	M2.1 ■ 31 C	M2.2 ■ 25 B	K1.1 ■ 30 C	K1.2 ■ 22 C
K1.3 ■ 17 C	K2.1 ■ 49 C	K2.2 ■ 40 C	K2.3 ■ 32 B	K3.1 ■ 44 C	K3.2 ■ 33 C	K3.3 ■ 27 A	K4.1 ■ 40 B	K4.2 ■ 30 B	K4.3 ■ 22 B	K4.4 ■ 19 A	K4.5 ■ 16 A	K5.1 ■ 46 B	K5.2 ■ 34 B
K5.3 ■ 27 B	N1.1 ■ 81 E	N1.2 ■ 60 D	N1.3 ■ 41 D	N2.1 ■ 41 C	N2.2 ■ 37 C	N2.3 ■ 26 C	N3.1 ■ 43 C	N3.2 ■ 25 C	N3.3 ■ 13 C	N4.1 ■ 43 C	S1.1 ■ 30 B	S1.2 ■ 25 B	S2.1 ■ 20 A
S3.1 ■ 15 A	S4.1 ■ 12 A												

DCON MS tolerance h6.

Product	DC [mm]	DCON MS [mm]	APMX [mm]	OAL [mm]	NOF	LU [mm]	DN [mm]
C1352.0	2.00	6.00	7.00	54.0	2	18.00	1.80
C1353.0	3.00	6.00	8.00	56.0	2	20.00	2.80
C1354.0	4.00	6.00	11.00	63.0	2	27.00	3.70
C1355.0	5.00	6.00	13.00	68.0	2	32.00	4.70
C1356.0	6.00	6.00	13.00	68.0	2	32.00	5.70
C1358.0	8.00	10.00	19.00	88.0	2	48.00	7.50
C13510.0	10.00	10.00	22.00	95.0	2	54.50	9.50
C13512.0	12.00	12.00	26.00	110.0	2	64.50	11.50
C13514.0	14.00	12.00	26.00	110.0	2	64.50	11.50
C13516.0	16.00	16.00	32.00	123.0	2	74.50	15.50
C13518.0	18.00	16.00	32.00	123.0	2	74.50	15.50
C13520.0	20.00	20.00	38.00	141.0	2	90.50	19.50



C306



3-Flute HSS-E-PM Slot End Mill, Bright Finish

Extra short cut length, 3-flute design provides high rigidity and is suitable for milling shallow slots and ramping. The accurate diameter means the tools are designed for milling standard keyway slots to a P9 tolerance. Versatile and can be used in mild steels and non-ferrous materials.

HSS-E PM	N	NOF 3
	λ 30°	γ 12°
DIN 1835B	Bright	DC e8
	DIN 327D	

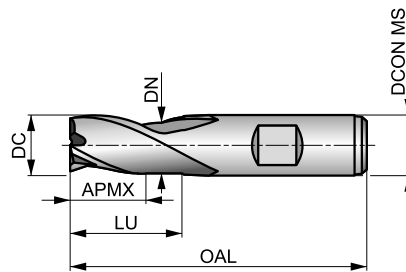

Workpiece material group suitability, starting values for cutting speed (m/min) and Alpha Code. Tables with feed per tooth and correction factors can be found starting from page 194.

P1.1 ■ 54 E	P1.2 ■ 61 E	P1.3 ■ 63 E	P2.1 ■ 47 E	P2.2 ■ 41 E	P3.1 ■ 38 E	P3.2 ■ 31 D	P4.1 ■ 23 D	M1.1 ■ 36 E	M1.2 ■ 30 E	M2.1 ■ 32 E	M2.2 ■ 26 D	K1.1 ■ 32 E	K1.2 ■ 24 E
K1.3 ■ 18 E	K2.1 ■ 59 E	K2.2 ■ 48 E	K2.3 ■ 38 D	K3.1 ■ 52 E	K3.2 ■ 40 E	K3.3 ■ 32 D	K4.1 ■ 48 D	K4.2 ■ 37 D	K4.3 ■ 27 D	K4.4 ■ 23 C	K4.5 ■ 19 C	K5.1 ■ 55 D	K5.2 ■ 41 D
K5.3 ■ 32 D	N1.3 ■ 50 F	N2.1 ■ 50 E	N2.2 ■ 45 E	N2.3 ■ 32 E	N3.1 ■ 52 E	N3.2 ■ 30 E	N3.3 ■ 16 E	N4.1 ■ 52 E	S1.1 ■ 33 D	S1.2 ■ 26 D	S2.1 ■ 20 C	S3.1 ■ 15 C	S4.1 ■ 12 C

DCON MS tolerance h6.

Product	DC [mm]	DCON MS [mm]	APMX [mm]	OAL [mm]	NOF	LU [mm]	DN [mm]
C3063.0	3.00	6.00	5.00	49.0	3	-	-
C3064.0	4.00	6.00	7.00	51.0	3	-	-
C3065.0	5.00	6.00	8.00	52.0	3	-	-
C3066.0	6.00	6.00	8.00	52.0	3	-	-
C3067.0	7.00	10.00	10.00	60.0	3	-	-
C3068.0	8.00	10.00	11.00	61.0	3	-	-
C3069.0	9.00	10.00	11.00	61.0	3	-	-
C3069.5	9.50	10.00	11.00	61.0	3	-	-
C30610.0	10.00	10.00	13.00	63.0	3	22.50	9.50
C30611.0	11.00	12.00	13.00	70.0	3	-	-
C30612.0	12.00	12.00	16.00	73.0	3	27.50	11.50
C30614.0	14.00	12.00	16.00	73.0	3	27.50	11.50
C30615.0	15.00	12.00	16.00	73.0	3	27.50	11.50
C30616.0	16.00	16.00	19.00	79.0	3	30.50	15.50
C30618.0	18.00	16.00	19.00	79.0	3	30.50	15.50
C30620.0	20.00	20.00	22.00	88.0	3	37.50	19.50
C30622.0	22.00	20.00	22.00	88.0	3	37.50	19.50
C30625.0	25.00	25.00	26.00	102.0	3	45.50	24.50
C30630.0	30.00	25.00	26.00	102.0	3	45.50	24.50



C353



3-Flute HSS-E-PM Slot End Mill, Alcrona Coating

Extra short cut length, 3-flute design provides high rigidity and is suitable for milling shallow slots and ramping. The accurate diameter means the tools are designed for milling standard keyway slots to a P9 tolerance. Alcrona coating improves performance and extends the tool life.

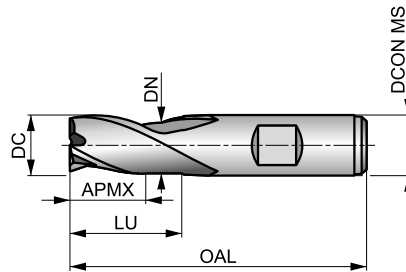
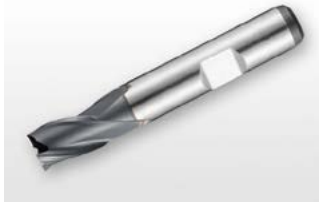

HSS-E PM	N	NOF 3
	λ 30°	γ 12°
DIN 1835B	Alcrona	DC e8
	DIN 327D	



Workpiece material group suitability, starting values for cutting speed (m/min) and Alpha Code. Tables with feed per tooth and correction factors can be found starting from page 194.

P1.1 ■ 133 E	P1.2 ■ 148 E	P1.3 ■ 154 E	P2.1 ■ 114 E	P2.2 ■ 100 E	P2.3 ■ 88 D	P3.1 ■ 88 E	P3.2 ■ 71 D	P3.3 ■ 60 D	P4.1 ■ 53 D	P4.2 ■ 45 D	P4.3 ▣ 37 D	M1.1 ▣ 69 E	M1.2 ▣ 58 E
M2.1 ▣ 61 E	M2.2 ▣ 50 D	M3.1 ▣ 52 D	M3.2 ▣ 45 D	M3.3 ▣ 41 C	M4.1 ▣ 30 C	K1.1 ■ 65 E	K1.2 ■ 48 E	K1.3 ■ 36 E	K2.1 ■ 117 E	K2.2 ■ 95 E	K2.3 ■ 76 D	K3.1 ■ 103 E	K3.2 ■ 79 E
K3.3 ■ 64 D	K4.1 ■ 96 D	K4.2 ■ 72 D	K4.3 ■ 53 D	K4.4 ■ 45 C	K4.5 ■ 38 C	K5.1 ■ 108 D	K5.2 ■ 82 D	K5.3 ■ 63 D	N1.3 ▣ 89 F	N2.1 ▣ 89 E	N2.2 ■ 80 E	N2.3 ■ 57 E	N3.1 ■ 93 E
N3.2 ■ 55 E	N3.3 ■ 28 E	N4.1 ▣ 93 E	S1.1 ■ 50 D	S1.2 ■ 40 D	S1.3 ▣ 20 C	S2.1 ■ 40 C	S2.2 ▣ 21 C	S3.1 ■ 30 C	S3.2 ▣ 15 C	S4.1 ■ 23 C	S4.2 ▣ 12 C		

DCON MS tolerance h6.

Product	DC [mm]	DCON MS [mm]	APMX [mm]	OAL [mm]	NOF	LU [mm]	DN [mm]
C3533.0	3.00	6.00	5.00	49.0	3	–	–
C3533.5	3.50	6.00	6.00	50.0	3	–	–
C3534.0	4.00	6.00	7.00	51.0	3	–	–
C3534.5	4.50	6.00	7.00	51.0	3	–	–
C3534.8 ¹⁾	4.80	6.00	8.00	52.0	3	–	–
C3535.0	5.00	6.00	8.00	52.0	3	–	–
C3535.5	5.50	6.00	8.00	52.0	3	–	–
C3536.0	6.00	6.00	8.00	52.0	3	–	–
C3536.5	6.50	10.00	10.00	60.0	3	–	–
C3537.0	7.00	10.00	10.00	60.0	3	–	–
C3537.5	7.50	10.00	10.00	60.0	3	–	–
C3537.75 ¹⁾	7.75	10.00	11.00	61.0	3	–	–
C3538.0	8.00	10.00	11.00	61.0	3	–	–
C3538.5	8.50	10.00	11.00	61.0	3	–	–
C3539.0	9.00	10.00	11.00	61.0	3	–	–
C3539.5	9.50	10.00	11.00	61.0	3	–	–
C35310.0	10.00	10.00	13.00	63.0	3	22.50	9.50
C35311.0	11.00	12.00	13.00	70.0	3	–	–
C35312.0	12.00	12.00	16.00	73.0	3	27.50	11.50
C35313.0	13.00	12.00	16.00	73.0	3	27.50	11.50
C35314.0	14.00	12.00	16.00	73.0	3	27.50	11.50
C35315.0	15.00	12.00	16.00	73.0	3	27.50	11.50
C35316.0	16.00	16.00	19.00	79.0	3	30.50	15.50
C35318.0	18.00	16.00	19.00	79.0	3	30.50	15.50
C35320.0	20.00	20.00	22.00	88.0	3	37.50	19.50



Product	DC	DCON MS	APMX	OAL	NOF	LU	DN
	[mm]	[mm]	[mm]	[mm]		[mm]	[mm]
C35322.0	22.00	20.00	22.00	88.0	3	37.50	19.50
C35325.0	25.00	25.00	26.00	102.0	3	45.50	24.50
C35328.0	28.00	25.00	26.00	102.0	3	45.50	24.50
C35330.0	30.00	25.00	26.00	102.0	3	45.50	24.50

¹⁾ DC tolerance h10.



C367



3-Flute HSS-E-PM Slot End Mill, Alcrona Coating

Extra short cut length, 3-flute design with a 40° helix. The sharp geometry is designed to machine mild steels, especially medium to high strength stainless steels and mild non-ferrous materials. The accurate diameter means that standard keyway slots to P9 tolerance can be milled. Alcrona coating extends tool life.

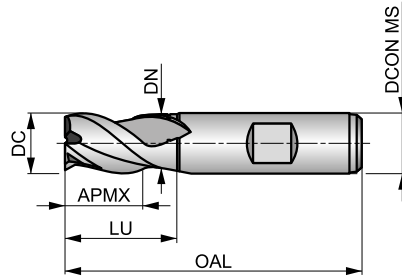

HSS-E PM	N	NOF 3
	λ 40°	γ 15°
DIN 1835B	Alcrona	DC e8
	DIN 327D	



Workpiece material group suitability, starting values for cutting speed (m/min) and Alpha Code. Tables with feed per tooth and correction factors can be found starting from page 194.

P1.1 ■ 135 E	P1.2 ■ 151 E	P1.3 ■ 157 E	P2.1 ■ 116 E	P2.2 ▧ 102 E	P3.1 ▧ 94 E	P3.2 ▧ 75 D	P4.1 ▧ 156 D	M1.1 ■ 92 E	M1.2 ■ 78 E	M2.1 ■ 82 E	M2.2 ■ 67 D	M2.3 ■ 56 D	M3.1 ■ 64 D
M3.2 ■ 55 D	M3.3 ■ 50 C	M4.1 ■ 35 C	M4.2 ■ 30 C	N1.1 ■ 177 G	N1.2 ■ 133 F	N1.3 ▧ 89 F	N2.1 ▧ 189 E	N2.2 ▧ 180 E	N2.3 ▧ 157 E	N3.1 ▧ 193 E	N3.2 ▧ 155 E	N3.3 ■ 28 E	N4.1 ▧ 93 E
S1.1 ▧ 150 D													

DCON MS tolerance h6.

Product	DC [mm]	DCON MS [mm]	APMX [mm]	OAL [mm]	NOF	LU [mm]	DN [mm]
C3672.0	2.00	6.00	4.00	48.0	3	–	–
C3673.0	3.00	6.00	5.00	49.0	3	–	–
C3674.0	4.00	6.00	7.00	51.0	3	–	–
C3675.0	5.00	6.00	8.00	52.0	3	–	–
C3676.0	6.00	6.00	8.00	52.0	3	–	–
C3677.0	7.00	10.00	10.00	60.0	3	–	–
C3678.0	8.00	10.00	11.00	61.0	3	–	–
C36710.0	10.00	10.00	13.00	63.0	3	22.50	9.50
C36711.0	11.00	12.00	13.00	70.0	3	–	–
C36712.0	12.00	12.00	16.00	73.0	3	27.50	11.50
C36714.0	14.00	12.00	16.00	73.0	3	27.50	11.50
C36716.0	16.00	16.00	19.00	79.0	3	30.50	15.50
C36718.0	18.00	16.00	19.00	79.0	3	30.50	15.50
C36720.0	20.00	20.00	22.00	88.0	3	37.50	19.50



C305



3-Flute HSS-E-PM Slot End Mill, Bright Finish

Short cut length, 3-flute design provides high rigidity for milling slots whilst the accurate diameter means that standard keyway slots to P9 tolerance can be milled. Suitable also for ramping and profile milling in mild steels, non-ferrous materials and medium strength high temperature alloys.

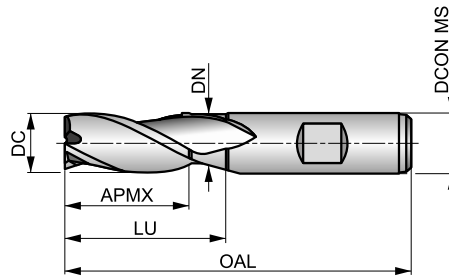

HSS-E PM	N	NOF 3
	λ 30°	γ 12°
DIN 1835B	Bright	DC e8
	DIN 844K	



Workpiece material group suitability, starting values for cutting speed (m/min) and Alpha Code. Tables with feed per tooth and correction factors can be found starting from page 194.

P1.1 ■ 52 D	P1.2 ■ 58 D	P1.3 ■ 60 D	P2.1 ■ 44 D	P2.2 ■ 39 D	P3.1 ■ 36 D	P3.2 ■ 29 C	P4.1 ■ 21 C	M1.1 ■ 36 D	M1.2 ■ 30 D	M2.1 ■ 32 D	M2.2 ■ 26 C	K1.1 ■ 30 D	K1.2 ■ 22 D
K1.3 ■ 17 D	K2.1 ■ 55 D	K2.2 ■ 45 D	K2.3 ■ 36 C	K3.1 ■ 49 D	K3.2 ■ 37 D	K3.3 ■ 30 B	K4.1 ■ 45 C	K4.2 ■ 34 C	K4.3 ■ 25 C	K4.4 ■ 22 B	K4.5 ■ 18 B	K5.1 ■ 51 C	K5.2 ■ 39 C
K5.3 ■ 30 C	N1.3 ■ 48 E	N2.1 ■ 48 D	N2.2 ■ 43 D	N2.3 ■ 31 D	N3.1 ■ 50 D	N3.2 ■ 29 D	N3.3 ■ 15 D	N4.1 ■ 50 D	S1.1 ■ 29 C	S1.2 ■ 24 C	S2.1 ■ 17 B	S3.1 ■ 13 B	S4.1 ■ 10 B

DCON MS tolerance h6.

Product	DC [mm]	DCON MS [mm]	APMX [mm]	OAL [mm]	NOF	LU [mm]	DN [mm]
C3052.0	2.00	6.00	7.00	51.0	3	-	-
C3052.5	2.50	6.00	8.00	52.0	3	-	-
C3053.0	3.00	6.00	8.00	52.0	3	-	-
C3053.5	3.50	6.00	10.00	54.0	3	-	-
C3054.0	4.00	6.00	11.00	55.0	3	-	-
C3054.5	4.50	6.00	11.00	55.0	3	-	-
C3055.0	5.00	6.00	13.00	57.0	3	-	-
C3055.5	5.50	6.00	13.00	57.0	3	-	-
C3056.0	6.00	6.00	13.00	57.0	3	-	-
C3056.5	6.50	10.00	16.00	66.0	3	-	-
C3057.0	7.00	10.00	16.00	66.0	3	-	-
C3057.5	7.50	10.00	16.00	66.0	3	-	-
C3058.0	8.00	10.00	19.00	69.0	3	-	-
C3058.5	8.50	10.00	19.00	69.0	3	-	-
C3059.0	9.00	10.00	19.00	69.0	3	-	-
C30510.0	10.00	10.00	22.00	72.0	3	31.50	9.50
C30511.0	11.00	12.00	22.00	79.0	3	-	-
C30512.0	12.00	12.00	26.00	83.0	3	37.50	11.50
C30513.0	13.00	12.00	26.00	83.0	3	37.50	11.50
C30514.0	14.00	12.00	26.00	83.0	3	37.50	11.50
C30515.0	15.00	12.00	26.00	83.0	3	37.50	11.50
C30516.0	16.00	16.00	32.00	92.0	3	43.50	15.50
C30517.0	17.00	16.00	32.00	92.0	3	43.50	15.50
C30518.0	18.00	16.00	32.00	92.0	3	43.50	15.50
C30519.0	19.00	16.00	32.00	92.0	3	43.50	15.50
C30520.0	20.00	20.00	38.00	104.0	3	53.50	19.50
C30522.0	22.00	20.00	38.00	104.0	3	53.50	19.50



Product	DC	DCON MS	APMX	OAL	NOF	LU	DN
	[mm]	[mm]	[mm]	[mm]		[mm]	[mm]
C30525.0	25.00	25.00	45.00	121.0	3	–	–
C30528.0	28.00	25.00	45.00	121.0	3	–	–
C30530.0	30.00	25.00	45.00	121.0	3	–	–
C30532.0	32.00	32.00	53.00	133.0	3	–	–



C352



3-Flute HSS-E-PM Slot End Mill, Alcrona Coating

Short cut length, 3-flute design provides high rigidity for milling slots whilst the accurate diameter means that standard keyway slots to P9 tolerance can be milled. Suitable also for ramping and profile milling in mild materials. Alcrona coating improves performance and extends the tool life.

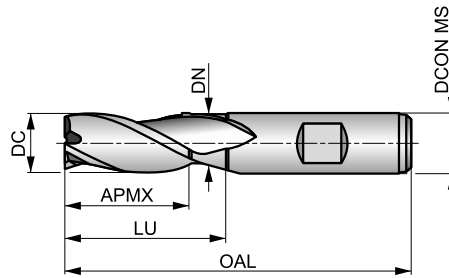

HSS-E PM	N	NOF 3
	λ 30°	γ 12°
DIN 1835B	Alcrona	DC e8
	DIN 844K	



Workpiece material group suitability, starting values for cutting speed (m/min) and Alpha Code. Tables with feed per tooth and correction factors can be found starting from page 194.

P1.1 ■ 126 D	P1.2 ■ 141 D	P1.3 ■ 146 D	P2.1 ■ 108 D	P2.2 ■ 95 D	P2.3 ■ 84 C	P3.1 ■ 81 D	P3.2 ■ 65 C	P3.3 ■ 55 C	P4.1 ■ 48 C	P4.2 ■ 41 C	P4.3 ▣ 34 C	M1.1 ▣ 69 D	M1.2 ▣ 58 D
M2.1 ▣ 61 D	M2.2 ▣ 50 C	M3.1 ▣ 47 C	M3.2 ▣ 40 C	M3.3 ▣ 36 B	M4.1 ▣ 25 B	K1.1 ■ 60 D	K1.2 ■ 44 D	K1.3 ■ 33 D	K2.1 ■ 111 D	K2.2 ■ 90 D	K2.3 ■ 72 C	K3.1 ■ 98 D	K3.2 ■ 75 D
K3.3 ■ 61 B	K4.1 ■ 91 C	K4.2 ■ 68 C	K4.3 ■ 50 C	K4.4 ■ 43 B	K4.5 ■ 36 B	K5.1 ■ 103 C	K5.2 ■ 77 C	K5.3 ■ 60 C	N1.3 ▣ 89 E	N2.1 ▣ 89 D	N2.2 ■ 80 D	N2.3 ■ 57 D	N3.1 ■ 93 D
N3.2 ■ 55 D	N3.3 ■ 28 D	N4.1 ▣ 93 D	S1.1 ■ 45 C	S1.2 ■ 35 C	S1.3 ▣ 15 B	S2.1 ■ 33 B	S2.2 ▣ 14 B	S3.1 ■ 25 B	S3.2 ▣ 10 B	S4.1 ■ 20 B	S4.2 ▣ 8 B		

DCON MS tolerance h6.

Product	DC [mm]	DCON MS [mm]	APMX [mm]	OAL [mm]	NOF	LU [mm]	DN [mm]
C3523.0	3.00	6.00	8.00	52.0	3	–	–
C3524.0	4.00	6.00	11.00	55.0	3	–	–
C3525.0	5.00	6.00	13.00	57.0	3	–	–
C3526.0	6.00	6.00	13.00	57.0	3	–	–
C3528.0	8.00	10.00	19.00	69.0	3	–	–
C35210.0	10.00	10.00	22.00	72.0	3	31.50	9.50
C35212.0	12.00	12.00	26.00	83.0	3	37.50	11.50
C35214.0	14.00	12.00	26.00	83.0	3	37.50	11.50
C35216.0	16.00	16.00	32.00	92.0	3	43.50	15.50
C35218.0	18.00	16.00	32.00	92.0	3	43.50	15.50
C35220.0	20.00	20.00	38.00	104.0	3	53.50	19.50



C159

2-Flute HSS-E Slot End Mill, Bright Finish

Short cut length, 2-flute design with 40° helix for milling slots, profile milling and ramping in softer materials, whilst the accurate diameter means standard keyway slots to P9 tolerance can be milled. Designed specifically for milling in non-ferrous materials.

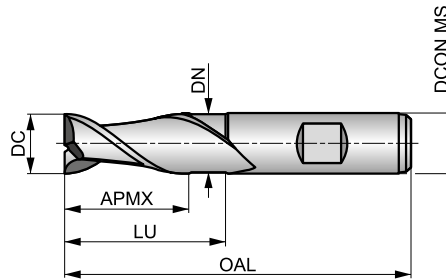

HSS-E	W	NOF 2
	λ 40°	γ 20°
DIN 1835B	Bright	DC e8
	DIN 844K	



Workpiece material group suitability, starting values for cutting speed (m/min) and Alpha Code. Tables with feed per tooth and correction factors can be found starting from page 194.

P1.1 ▣46 D	P1.2 ▣52 D	P1.3 ▣54 D	P2.1 ▣40 D	P2.2 ▣35 D	M1.1 ▣32 D	M1.2 ▣27 D	M2.1 ▣28 D	M2.2 ▣23 C	M3.1 ▣22 C	M3.2 ▣19 C	N1.1 ■142 F	N1.2 ■107 E	N1.3 ■72 E
N2.1 ■72 D	N2.2 ■64 D	N2.3 ▣46 D	N3.1 ■75 D	N3.2 ■44 D	N3.3 ■22 D	N4.1 ■75 D	N4.2 ■29 D	S1.1 ▣28 C					

DCON MS tolerance h6.

Product	DC [mm]	DCON MS [mm]	APMX [mm]	OAL [mm]	NOF	LU [mm]	DN [mm]
C1592.0	2.00	6.00	7.00	51.0	2	–	–
C1593.0	3.00	6.00	8.00	52.0	2	–	–
C1594.0	4.00	6.00	11.00	55.0	2	–	–
C1595.0	5.00	6.00	13.00	57.0	2	–	–
C1596.0	6.00	6.00	13.00	57.0	2	–	–
C1598.0	8.00	10.00	19.00	69.0	2	–	–
C15910.0	10.00	10.00	22.00	72.0	2	–	–
C15912.0	12.00	12.00	26.00	83.0	2	–	–
C15914.0	14.00	12.00	26.00	83.0	2	37.50	11.50
C15916.0	16.00	16.00	32.00	92.0	2	43.50	15.50
C15918.0	18.00	16.00	32.00	92.0	2	43.50	15.50
C15920.0	20.00	20.00	38.00	104.0	2	53.50	19.50



C336



3-Flute HSS-E-PM End Mill, Bright Finish

Short cut length, 3-flute design with a 40° helix. The flute with neck recess provides high rigidity for machining deeper slots and profiles. Designed specifically for milling non-ferrous materials.

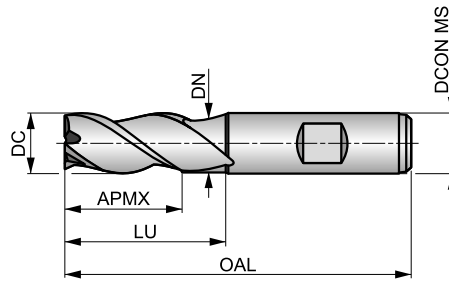

HSS-E PM	W	NOF 3
	λ 40°	γ 25°
DIN 1835B	Bright	DC k10
	DIN 844K	



Workpiece material group suitability, starting values for cutting speed (m/min) and Alpha Code. Tables with feed per tooth and correction factors can be found starting from page 194.

P1.1 ■ 50 D	P1.2 ■ 56 D	P1.3 ■ 58 D	P2.1 ■ 43 D	P2.2 ■ 38 D	M1.1 ■ 34 D	M1.2 ■ 29 D	M2.1 ■ 31 D	M2.2 ■ 25 C	M3.1 ■ 24 C	M3.2 ■ 21 C	N1.1 ■ 142 F	N1.2 ■ 107 E	N1.3 ■ 72 E
N2.1 ■ 72 D	N2.2 ■ 64 D	N2.3 ■ 46 D	N3.1 ■ 75 D	N3.2 ■ 44 D	N3.3 ■ 22 D	N4.1 ■ 75 D	N4.2 ■ 29 D	S1.1 ■ 30 C					

DCON MS tolerance h6.

Product	DC [mm]	DCON MS [mm]	APMX [mm]	OAL [mm]	NOF	LU [mm]	DN [mm]
C33610.0	10.00	10.00	22.00	72.0	3	31.50	9.50
C33612.0	12.00	12.00	26.00	83.0	3	37.50	11.50
C33614.0	14.00	12.00	26.00	83.0	3	37.50	11.50
C33616.0	16.00	16.00	32.00	92.0	3	43.50	15.50
C33618.0	18.00	16.00	32.00	92.0	3	43.50	15.50
C33620.0	20.00	20.00	38.00	104.0	3	53.50	19.50
C33622.0	22.00	20.00	38.00	104.0	3	53.50	19.50
C33625.0	25.00	25.00	45.00	121.0	3	64.50	24.50
C33630.0	30.00	25.00	45.00	121.0	3	64.50	24.50



C167



2-flute HSS-E Extra Long Reach End Mill, Bright Finish

Short cut length, 2-flute design without neck recess and with extra long reach for machining extra deep pockets in difficult to reach areas. Suitable for milling in mild steels and non-ferrous materials.

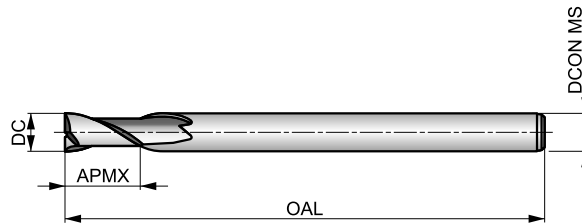

HSS-E	N	NOF 2
	λ 30°	γ 12°
DIN 1835A	Bright	DC js14



Workpiece material group suitability, starting values for cutting speed (m/min) and Alpha Code. Tables with feed per tooth and correction factors can be found starting from page 194.

P1.1 ■ 46 C	P1.2 ■ 52 C	P1.3 ■ 54 C	P2.1 ■ 40 C	P2.2 ■ 35 C	P3.1 ■ 32 C	P3.2 ■ 26 B	P4.1 ■ 19 B	M1.1 ■ 34 C	M1.2 ■ 29 C	M2.1 ■ 31 C	M2.2 ■ 25 B	K1.1 ■ 30 C	K1.2 ■ 22 C
K1.3 ■ 17 C	K2.1 ■ 49 C	K2.2 ■ 40 C	K2.3 ■ 32 B	K3.1 ■ 44 C	K3.2 ■ 33 C	K3.3 ■ 27 A	K4.1 ■ 40 B	K4.2 ■ 30 B	K4.3 ■ 22 B	K4.4 ■ 19 A	K4.5 ■ 16 A	K5.1 ■ 46 B	K5.2 ■ 34 B
K5.3 ■ 27 B	N1.1 ■ 81 E	N1.2 ■ 60 D	N1.3 ■ 41 D	N2.1 ■ 41 C	N2.2 ■ 37 C	N2.3 ■ 26 C	N3.1 ■ 43 C	N3.2 ■ 25 C	N3.3 ■ 13 C	N4.1 ■ 43 C	S1.1 ■ 30 B	S1.2 ■ 25 B	S2.1 ■ 20 A
S3.1 ■ 15 A	S4.1 ■ 12 A												

DCON MS tolerance h6.

Product	DC [mm]	DCON MS [mm]	APMX [mm]	OAL [mm]	NOF
C1676.0	6.00	6.00	13.00	180.0	2
C1678.0	8.00	8.00	19.00	180.0	2
C16710.0	10.00	10.00	22.00	200.0	2
C16712.0	12.00	12.00	26.00	200.0	2
C16716.0	16.00	16.00	32.00	200.0	2



C122



2-flute HSS-E Extra Long Series End Mill, Bright Finish

Long cut length, 2-flute design provides high rigidity for milling standard slots. Designed for machining deep slots in difficult to reach areas in mild steels and non-ferrous materials.

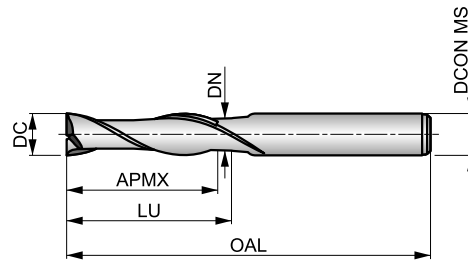

HSS-E	N	NOF 2
	λ 30°	γ 12°
DIN 1835A	Bright	DC e8



Workpiece material group suitability, starting values for cutting speed (m/min) and Alpha Code. Tables with feed per tooth and correction factors can be found starting from page 194.

P1.1 ■ 41 C	P1.2 ■ 46 C	P1.3 ■ 48 C	P2.1 ■ 35 C	P2.2 ■ 31 C	P3.1 ■ 28 C	P3.2 ■ 23 B	P4.1 ■ 17 B	M1.1 ■ 27 C	M1.2 ■ 23 C	M2.1 ■ 24 C	M2.2 ■ 20 B	K1.1 ■ 25 C	K1.2 ■ 19 C
K1.3 ■ 14 C	K2.1 ■ 44 C	K2.2 ■ 36 C	K2.3 ■ 29 B	K3.1 ■ 39 C	K3.2 ■ 30 C	K3.3 ■ 24 A	K4.1 ■ 36 B	K4.2 ■ 27 B	K4.3 ■ 20 B	K4.4 ■ 17 A	K4.5 ■ 14 A	K5.1 ■ 41 B	K5.2 ■ 31 B
K5.3 ■ 24 B	N1.1 ■ 76 E	N1.2 ■ 57 D	N1.3 ■ 38 D	N2.1 ■ 38 C	N2.2 ■ 34 C	N2.3 ■ 25 C	N3.1 ■ 40 C	N3.2 ■ 23 C	N3.3 ■ 12 C	N4.1 ■ 40 C	S1.1 ■ 25 B	S1.2 ■ 20 B	S2.1 ■ 15 A
S3.1 ■ 11 A	S4.1 ■ 9 A												

DCON MS tolerance h6.

Product	DC [mm]	DCON MS [mm]	APMX [mm]	OAL [mm]	NOF	LU [mm]	DN [mm]
C1225.0	5.00	5.00	22.00	65.0	2	—	—
C1226.0	6.00	6.00	27.00	75.0	2	—	—
C1227.0	7.00	8.00	33.00	85.0	2	—	—
C1228.0	8.00	8.00	33.00	85.0	2	—	—
C12210.0	10.00	10.00	40.00	95.0	2	—	—
C12212.0	12.00	12.00	45.00	110.0	2	—	—
C12214.0	14.00	12.00	52.00	125.0	2	—	—
C12216.0	16.00	16.00	58.00	140.0	2	69.50	15.50
C12218.0	18.00	16.00	65.00	150.0	2	76.50	15.50
C12220.0	20.00	20.00	70.00	160.0	2	85.50	19.50
C12222.0	22.00	20.00	75.00	170.0	2	90.50	19.50



C346

3-Flute HSS-E Long Series End Mill, Bright Finish

Long cut length, 3-flute design provides high rigidity for standard slotting and profile milling in mild steels and non-ferrous materials. Long series cutter designed for machining deeper slots and walls in places which are difficult to reach.

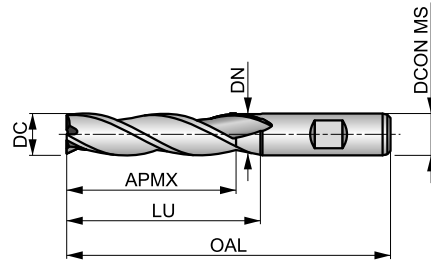

HSS-E	N	NOF 3
	λ 30°	γ 12°
DIN 1835B	Bright	DC e8
	DIN 844L	



Workpiece material group suitability, starting values for cutting speed (m/min) and Alpha Code. Tables with feed per tooth and correction factors can be found starting from page 194.

P1.1 ■ 40 C	P1.2 ■ 45 C	P1.3 ■ 46 C	P2.1 ■ 34 C	P2.2 ■ 30 C	P3.1 ■ 28 C	P3.2 ■ 22 B	P4.1 ■ 16 B	M1.1 ■ 27 C	M1.2 ■ 23 C	M2.1 ■ 24 C	M2.2 ■ 20 B	K1.1 ■ 25 C	K1.2 ■ 19 C
K1.3 ■ 14 C	K2.1 ■ 43 C	K2.2 ■ 35 C	K2.3 ■ 28 B	K3.1 ■ 38 C	K3.2 ■ 29 C	K3.3 ■ 24 A	K4.1 ■ 35 B	K4.2 ■ 27 B	K4.3 ■ 20 B	K4.4 ■ 17 A	K4.5 ■ 14 A	K5.1 ■ 40 B	K5.2 ■ 30 B
K5.3 ■ 23 B	N1.1 ■ 76 E	N1.2 ■ 57 D	N1.3 ■ 38 D	N3.1 ■ 40 C	N3.2 ■ 23 C	N3.3 ■ 12 C	N4.1 ■ 40 C	S1.1 ■ 25 B	S1.2 ■ 20 B	S2.1 ■ 13 A	S3.1 ■ 10 A	S4.1 ■ 8 A	

DCON MS tolerance h6.

Product	DC [mm]	DCON MS [mm]	APMX [mm]	OAL [mm]	NOF	LU [mm]	DN [mm]
C3463.0	3.00	6.00	12.00	56.0	3	–	–
C3464.0	4.00	6.00	19.00	63.0	3	–	–
C3465.0	5.00	6.00	24.00	68.0	3	–	–
C3466.0	6.00	6.00	24.00	68.0	3	–	–
C3467.0	7.00	10.00	30.00	80.0	3	–	–
C3468.0	8.00	10.00	38.00	88.0	3	–	–
C3469.0	9.00	10.00	38.00	88.0	3	–	–
C34610.0	10.00	10.00	45.00	95.0	3	–	–
C34611.0	11.00	12.00	45.00	102.0	3	–	–
C34612.0	12.00	12.00	53.00	110.0	3	–	–
C34613.0	13.00	12.00	53.00	110.0	3	64.50	11.50
C34615.0	15.00	12.00	53.00	110.0	3	64.50	11.50
C34616.0	16.00	16.00	63.00	123.0	3	74.50	15.50
C34620.0	20.00	20.00	75.00	141.0	3	90.50	19.50



C299



3-4 Flute HSS-E-PM End Mill, Bright Finish

Short cut length, 3 or 4 flute design provides high rigidity for general profile and ramp milling applications. With a 45° helix and designed for machining higher strength materials. Neck recess on cutting diameter equal to 10 mm and above.

HSS-E PM	N	NOF 3-4
	λ 45°	γ 12°
DIN 1835B	Bright	DC k10
	DIN 844K	

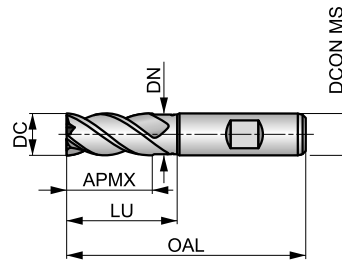

Workpiece material group suitability, starting values for cutting speed (m/min) and Alpha Code. Tables with feed per tooth and correction factors can be found starting from page 194.

P2.2 ■ 37 D	P2.3 ■ 33 C	P3.1 ■ 32 D	P3.2 ■ 26 C	P3.3 ■ 22 C	P4.1 ■ 19 C	P4.2 ■ 16 C	P4.3 ■ 13 C	M1.1 ■ 36 D	M1.2 ■ 30 D	M2.1 ■ 32 D	M2.2 ■ 26 C	M3.1 ■ 24 C	M3.2 ■ 21 C
M3.3 ■ 19 B	M4.1 ■ 13 B	K1.1 ■ 30 D	K1.2 ■ 22 D	K1.3 ■ 17 D	K2.1 ■ 55 D	K2.2 ■ 45 D	K2.3 ■ 36 C	K3.1 ■ 49 D	K3.2 ■ 37 D	K3.3 ■ 30 B	K4.1 ■ 45 C	K4.2 ■ 34 C	K4.3 ■ 25 C
K4.4 ■ 22 B	K4.5 ■ 18 B	K5.1 ■ 51 C	K5.2 ■ 39 C	K5.3 ■ 30 C	N3.1 ■ 43 D	N3.2 ■ 25 D	S1.1 ■ 29 C	S1.2 ■ 57 C	S1.3 ■ 10 B	S2.1 ■ 17 B	S2.2 ■ 7 B	S3.1 ■ 13 B	S3.2 ■ 5 B
S4.1 ■ 10 B	S4.2 ■ 4 B												

DCON MS tolerance h6.

Product	DC [mm]	DCON MS [mm]	APMX [mm]	OAL [mm]	NOF	LU [mm]	DN [mm]
C2993.0	3.00	6.00	8.00	52.0	3	–	–
C2994.0	4.00	6.00	11.00	55.0	3	–	–
C2995.0	5.00	6.00	13.00	57.0	3	–	–
C2996.0	6.00	6.00	13.00	57.0	3	–	–
C2998.0	8.00	10.00	19.00	69.0	4	–	–
C29910.0	10.00	10.00	22.00	72.0	4	31.50	9.50
C29912.0	12.00	12.00	26.00	83.0	4	37.50	11.50
C29914.0	14.00	12.00	26.00	83.0	4	37.50	11.50
C29916.0	16.00	16.00	32.00	92.0	4	43.50	15.50
C29918.0	18.00	16.00	32.00	92.0	4	43.50	15.50
C29920.0	20.00	20.00	38.00	104.0	4	53.50	19.50



C907



Multi-Flute HSS-E-PM End Mill, Alcrona Coating

Short cut length, 3, 4, 5 or 6 flute design provides high rigidity for general profile and ramp milling applications. With a 45° helix and designed for machining higher strength materials. Neck recess on cutting diameter equal to 10 mm and above. Alcrona coating improves performance and extends the tool life.

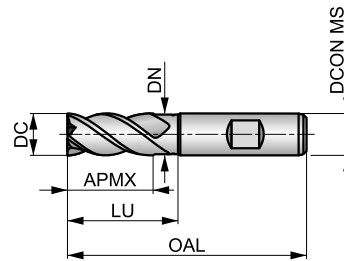

HSS-E PM	N	NOF 3-6
	λ 45°	γ 12°
DIN 1835B	Alcrona	DC k10
	DIN 844K	



Workpiece material group suitability, starting values for cutting speed (m/min) and Alpha Code. Tables with feed per tooth and correction factors can be found starting from page 194.

P2.2 ■ 95 D	P2.3 ■ 84 C	P3.1 ■ 81 D	P3.2 ■ 65 C	P3.3 ■ 55 C	P4.1 ■ 48 C	P4.2 ■ 41 C	P4.3 ■ 34 C	M1.1 ■ 69 D	M1.2 ■ 58 D	M2.1 ■ 61 D	M2.2 ■ 50 C	M3.1 ■ 47 C	M3.2 ■ 40 C
M3.3 ■ 36 B	M4.1 ■ 25 B	K1.1 ■ 60 D	K1.2 ■ 44 D	K1.3 ■ 33 D	K2.1 ■ 111 D	K2.2 ■ 90 D	K2.3 ■ 72 C	K3.1 ■ 98 D	K3.2 ■ 75 D	K3.3 ■ 61 B	K4.1 ■ 91 C	K4.2 ■ 68 C	K4.3 ■ 50 C
K4.4 ■ 43 B	K4.5 ■ 36 B	K5.1 ■ 103 C	K5.2 ■ 77 C	K5.3 ■ 60 C	N3.1 ■ 93 D	N3.2 ■ 55 D	S1.1 ■ 45 C	S1.2 ■ 85 C	S1.3 ■ 15 B	S2.1 ■ 33 B	S2.2 ■ 14 B	S3.1 ■ 25 B	S3.2 ■ 10 B
S4.1 ■ 20 B	S4.2 ■ 8 B												

DCON MS tolerance h6.

Product	DC [mm]	DCON MS [mm]	APMX [mm]	OAL [mm]	NOF	LU [mm]	DN [mm]
C9073.0	3.00	6.00	8.00	52.0	3	–	–
C9074.0	4.00	6.00	11.00	55.0	3	–	–
C9075.0	5.00	6.00	13.00	57.0	3	–	–
C9076.0	6.00	6.00	13.00	57.0	3	–	–
C9078.0	8.00	10.00	19.00	69.0	4	–	–
C90710.0	10.00	10.00	22.00	72.0	4	31.50	9.50
C90712.0	12.00	12.00	26.00	83.0	4	37.50	11.50
C90714.0	14.00	12.00	26.00	83.0	4	37.50	11.50
C90716.0	16.00	16.00	32.00	92.0	4	43.50	15.50
C90718.0	18.00	16.00	32.00	92.0	4	43.50	15.50
C90720.0	20.00	20.00	38.00	104.0	4	53.50	19.50
C90722.0	22.00	20.00	38.00	104.0	5	53.50	19.50
C90725.0	25.00	25.00	45.00	121.0	5	64.50	24.50
C90728.0	28.00	25.00	45.00	121.0	6	64.50	24.50
C90730.0	30.00	25.00	45.00	121.0	6	64.50	24.50
C90732.0	32.00	32.00	53.00	133.0	6	72.50	31.50



C920



Multi-Flute HSS-E-PM Long Series End Mill, Alcrona Coating

Long cut length, 3, 4 or 5 flute design for high rigidity finishing deep profiles. With a 45° helix and designed for machining higher strength materials. Neck recess on cutting diameter equal to 10 mm and above to avoid work contact with the wall and extend reach. Alcrona coating extends the tool life.

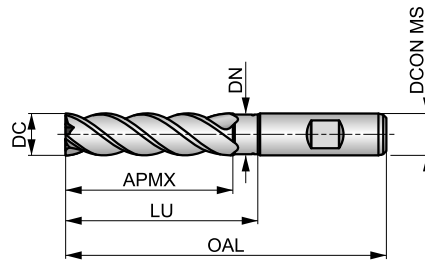

HSS-E PM	N	NOF 3-5
	λ 45°	γ 12°
	Alcrona	DC k10
	DIN 844L	

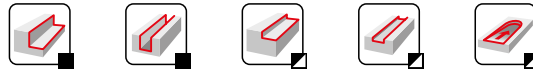

Workpiece material group suitability, starting values for cutting speed (m/min) and Alpha Code. Tables with feed per tooth and correction factors can be found starting from page 194.

P2.2 ■ 85 C	P2.3 ■ 75 B	P3.1 ■ 74 C	P3.2 ■ 59 B	P3.3 ■ 50 B	P4.1 ■ 44 B	P4.2 ■ 37 B	P4.3 ■ 31 B	M1.1 ■ 62 C	M1.2 ■ 52 C	M2.1 ■ 55 C	M2.2 ■ 45 B	M3.1 ■ 41 B	M3.2 ■ 35 B
M3.3 ■ 32 A	M4.1 ■ 25 A	K1.1 ■ 55 C	K1.2 ■ 41 C	K1.3 ■ 31 C	K2.1 ■ 98 C	K2.2 ■ 80 C	K2.3 ■ 64 B	K3.1 ■ 87 C	K3.2 ■ 67 C	K3.3 ■ 54 A	K4.1 ■ 81 B	K4.2 ■ 61 B	K4.3 ■ 45 B
K4.4 ■ 38 A	K4.5 ■ 32 A	K5.1 ■ 91 B	K5.2 ■ 69 B	K5.3 ■ 53 B	N3.1 ■ 83 C	N3.2 ■ 49 C	S1.1 ■ 40 B	S1.2 ■ 35 B	S1.3 ■ 15 A	S2.1 ■ 33 A	S2.2 ■ 14 A	S3.1 ■ 25 A	S3.2 ■ 10 A
S4.1 ■ 20 A	S4.2 ■ 8 A												

DCON MS tolerance h6.

Product	DC	DCON MS	APMX	OAL	NOF	LU	DN
	[mm]	[mm]	[mm]	[mm]		[mm]	[mm]
C9206.0	6.00	6.00	24.00	68.0	3	–	–
C9208.0	8.00	10.00	38.00	88.0	4	–	–
C92010.0	10.00	10.00	45.00	95.0	4	54.50	9.50
C92012.0	12.00	12.00	53.00	110.0	4	64.50	11.50
C92014.0	14.00	12.00	53.00	110.0	4	64.50	11.50
C92016.0	16.00	16.00	63.00	123.0	4	74.50	15.50
C92018.0	18.00	16.00	63.00	123.0	4	74.50	15.50
C92020.0	20.00	20.00	75.00	141.0	4	90.50	19.50
C92022.0	22.00	20.00	75.00	141.0	5	90.50	19.50
C92025.0	25.00	25.00	90.00	166.0	5	109.50	24.50



C247



Multi-Flute HSS-E-PM End Mill, Brigh Finish

Short cut length, 4, 5, 6 or 8 flute design provides high rigidity for general profile and ramp milling applications in mild steels and non-ferrous materials.

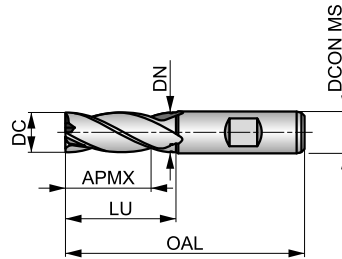

HSS-E PM	N	NOF 4-8
	λ 30°	γ 12°
DIN 1835B	Bright	DC k10
	DIN 844K	



Workpiece material group suitability, starting values for cutting speed (m/min) and Alpha Code. Tables with feed per tooth and correction factors can be found starting from page 194.

P1.1 ■ 53 D	P1.2 ■ 59 D	P1.3 ■ 61 D	P2.1 ■ 45 D	P2.2 ■ 40 D	P3.1 ■ 36 D	P3.2 ■ 29 C	P4.1 ■ 22 C	M1.1 ■ 34 D	M1.2 ■ 29 D	M2.1 ■ 31 D	M2.2 ■ 25 C	K1.1 ■ 30 D	K1.2 ■ 22 D
K1.3 ■ 17 D	K2.1 ■ 55 D	K2.2 ■ 45 D	K2.3 ■ 36 C	K3.1 ■ 49 D	K3.2 ■ 37 D	K3.3 ■ 30 B	K4.1 ■ 45 C	K4.2 ■ 34 C	K4.3 ■ 25 C	K4.4 ■ 22 B	K4.5 ■ 18 B	K5.1 ■ 51 C	K5.2 ■ 39 C
K5.3 ■ 130 C	N1.1 ■ 95 F	N1.2 ■ 71 E	N1.3 ■ 48 E	N2.1 ■ 48 D	N2.2 ■ 43 D	N2.3 ■ 31 D	N3.1 ■ 50 D	N3.2 ■ 29 D	N3.3 ■ 15 D	N4.1 ■ 50 D	S1.1 ■ 30 C	S1.2 ■ 25 C	S2.1 ■ 20 B
S3.1 ■ 15 B	S4.1 ■ 12 B												

DCON MS tolerance h6.

Product	DC [inch]	DC [mm]	DCON MS [mm]	APMX [mm]	OAL [mm]	NOF	LU [mm]	DN [mm]
C2472.0	–	2.00	6.00	7.00	51.0	4	–	–
C2472.5	–	2.50	6.00	8.00	52.0	4	–	–
C2473.0	–	3.00	6.00	8.00	52.0	4	–	–
C2471/8 ²⁾	1/8	3.18	6.00	10.00	54.0	4	–	–
C2473.5	–	3.50	6.00	10.00	54.0	4	–	–
C2474.0	–	4.00	6.00	11.00	55.0	4	–	–
C2474.5	–	4.50	6.00	11.00	55.0	4	–	–
C2473/16 ²⁾	3/16	4.76	6.00	13.00	57.0	4	–	–
C2475.0	–	5.00	6.00	13.00	57.0	4	–	–
C2475.5	–	5.50	6.00	13.00	57.0	4	–	–
C2476.0	–	6.00	6.00	13.00	57.0	4	–	–
C2471/4 ²⁾	1/4	6.35	10.00	16.00	66.0	4	–	–
C2476.5	–	6.50	10.00	16.00	66.0	4	–	–
C2477.0	–	7.00	10.00	16.00	66.0	4	–	–
C2477.5	–	7.50	10.00	16.00	66.0	4	–	–
C2475/16 ²⁾	5/16	7.94	10.00	19.00	69.0	4	–	–
C2478.0	–	8.00	10.00	19.00	69.0	4	–	–
C2478.5	–	8.50	10.00	19.00	69.0	4	–	–
C2479.0	–	9.00	10.00	19.00	69.0	4	–	–
C2479.5	–	9.50	10.00	19.00	69.0	4	–	–
C2473/8 ²⁾	3/8	9.52	10.00	22.00	72.0	4	31.50	9.50
C24710.0	–	10.00	10.00	22.00	72.0	4	31.50	9.50
C24711.0	–	11.00	12.00	22.00	79.0	4	–	–
C24712.0	–	12.00	12.00	26.00	83.0	4	37.50	11.50
C2471/2 ²⁾	1/2	12.70	12.00	26.00	83.0	4	37.50	11.50



Product	DC	DC	D CON MS	APMX	OAL	NOF	LU	DN
	[inch]	[mm]	[mm]	[mm]	[mm]		[mm]	[mm]
C24713.0	–	13.00	12.00	26.00	83.0	4	37.50	11.50
C24714.0	–	14.00	12.00	26.00	83.0	4	37.50	11.50
C2479/16²⁾	9/16	14.29	12.00	26.00	83.0	4	37.50	11.50
C24715.0	–	15.00	12.00	26.00	83.0	4	37.50	11.50
C2475/8²⁾	5/8	15.88	16.00	32.00	92.0	4	43.50	15.50
C24716.0	–	16.00	16.00	32.00	92.0	4	43.50	15.50
C24717.0	–	17.00	16.00	32.00	92.0	4	43.50	15.50
C24718.0	–	18.00	16.00	32.00	92.0	4	43.50	15.50
C24719.0	–	19.00	16.00	32.00	92.0	4	43.50	15.50
C2473/4²⁾	3/4	19.05	20.00	38.00	104.0	4	53.50	18.50
C24720.0	–	20.00	20.00	38.00	104.0	4	53.50	19.50
C24721.0	–	21.00	20.00	38.00	104.0	4	53.50	19.50
C24722.0	–	22.00	20.00	38.00	104.0	5	53.50	19.50
C2477/8²⁾	7/8	22.22	20.00	38.00	104.0	5	53.50	19.50
C24723.0	–	23.00	20.00	38.00	104.0	5	53.50	19.50
C24724.0	–	24.00	25.00	45.00	121.0	5	64.50	23.50
C24725.0	–	25.00	25.00	45.00	121.0	5	64.50	24.50
C2471²⁾	1"	25.40	25.00	45.00	121.0	5	64.50	24.50
C24726.0	–	26.00	25.00	45.00	121.0	6	64.50	24.50
C24728.0	–	28.00	25.00	45.00	121.0	6	64.50	24.50
C24730.0	–	30.00	25.00	45.00	121.0	6	64.50	24.50
C24732.0	–	32.00	32.00	53.00	133.0	6	72.50	31.50
C24736.0¹⁾	–	36.00	32.00	53.00	133.0	6	72.50	31.50
C24740.0¹⁾	–	40.00	40.00	63.00	155.0	6	84.50	39.00
C24750.0¹⁾	–	50.00	50.00	75.00	177.0	8	96.50	48.00

¹⁾ Available in HSS-E only; no centre cutting.

²⁾ DC tolerance +0.0025 inches / -0.0005 inches.



C246



Multi-Flute HSS-E-PM End Mill, TiCN Coating

Short cut length, 4 or 5 flute design provides high rigidity for general profile and ramp milling applications. TiCN coating increases the life of the cutter and improves performance when milling hard and abrasive materials.

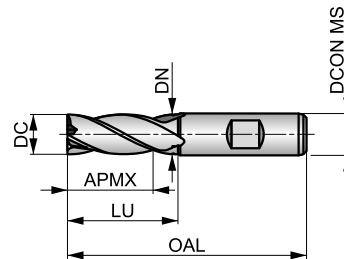

HSS-E PM	N	NOF 4-5
	λ 30°	γ 12°
DIN 1835B	TiCN	DC k10
	DIN 844K	



Workpiece material group suitability, starting values for cutting speed (m/min) and Alpha Code. Tables with feed per tooth and correction factors can be found starting from page 194.

P1.1 ■ 113 D	P1.2 ■ 126 D	P1.3 ■ 131 D	P2.1 ■ 97 D	P2.2 ■ 85 D	P2.3 ■ 75 C	P3.1 ■ 74 D	P3.2 ■ 59 C	P3.3 ■ 50 C	P4.1 ■ 44 C	P4.2 ■ 37 C	P4.3 ■ 31 C	M1.1 ■ 62 D	M1.2 ■ 52 D
M2.1 ■ 55 D	M2.2 ■ 45 C	M3.3 ■ 26 B	M4.1 ■ 25 B	K1.1 ■ 55 D	K1.2 ■ 41 D	K1.3 ■ 31 D	K2.1 ■ 97 D	K2.2 ■ 79 D	K2.3 ■ 63 C	K3.1 ■ 86 D	K3.2 ■ 66 D	K3.3 ■ 53 B	K4.1 ■ 80 C
K4.2 ■ 60 C	K4.3 ■ 44 C	K4.4 ■ 38 B	K4.5 ■ 31 B	K5.1 ■ 90 C	K5.2 ■ 68 C	K5.3 ■ 52 C	N1.1 ■ 159 F	N1.2 ■ 120 E	N1.3 ■ 80 E	N2.1 ■ 80 D	N2.2 ■ 72 D	N2.3 ■ 51 D	N3.1 ■ 84 D
N3.2 ■ 50 D	N3.3 ■ 25 D	N4.1 ■ 84 D	S1.1 ■ 43 C	S1.2 ■ 35 C	S1.3 ■ 15 B	S2.1 ■ 32 B	S2.2 ■ 14 B	S3.1 ■ 24 B	S3.2 ■ 10 B	S4.1 ■ 19 B	S4.2 ■ 8 B		

DCON MS tolerance h6.

Product	DC [mm]	DCON MS [mm]	APMX [mm]	OAL [mm]	NOF	LU [mm]	DN [mm]
C2462.0	2.00	6.00	7.00	51.0	4	–	–
C2463.0	3.00	6.00	8.00	52.0	4	–	–
C2464.0	4.00	6.00	11.00	55.0	4	–	–
C2465.0	5.00	6.00	13.00	57.0	4	–	–
C2466.0	6.00	6.00	13.00	57.0	4	–	–
C2467.0	7.00	10.00	16.00	66.0	4	–	–
C2468.0	8.00	10.00	19.00	69.0	4	–	–
C24610.0	10.00	10.00	22.00	72.0	4	31.50	9.50
C24611.0	11.00	12.00	22.00	79.0	4	–	–
C24612.0	12.00	12.00	26.00	83.0	4	37.50	11.50
C24613.0	13.00	12.00	26.00	83.0	4	37.50	11.50
C24614.0	14.00	12.00	26.00	83.0	4	37.50	11.50
C24615.0	15.00	12.00	26.00	83.0	4	37.50	11.50
C24616.0	16.00	16.00	32.00	92.0	4	43.50	15.50
C24618.0	18.00	16.00	32.00	92.0	4	43.50	15.50
C24620.0	20.00	20.00	38.00	104.0	4	53.50	19.50
C24622.0	22.00	20.00	38.00	104.0	5	53.50	19.50
C24625.0	25.00	25.00	45.00	121.0	5	64.50	24.50



C273



Multi-Flute HSS-E-PM Long Series End Mill, Bright Finish

Long cut length, 4, 5 or 6 flute design provides high rigidity for finishing deep profiles in mild steels and non-ferrous materials, such as aluminium and medium strength titanium alloys.

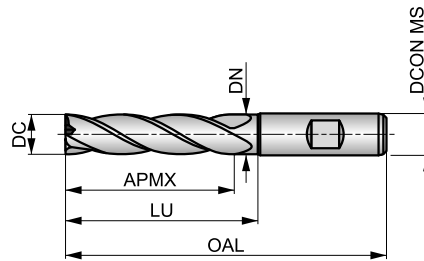

HSS-E PM	N	NOF 4-6
	λ 30°	γ 12°
	Bright	DC k10
	DIN 844L	

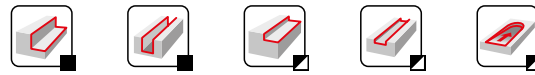

Workpiece material group suitability, starting values for cutting speed (m/min) and Alpha Code. Tables with feed per tooth and correction factors can be found starting from page 194.

P1.1 ■ 46 C	P1.2 ■ 52 C	P1.3 ■ 54 C	P2.1 ■ 40 C	P2.2 ■ 35 C	P3.1 ■ 32 C	P3.2 ■ 26 B	P4.1 ■ 19 B	M1.1 ■ 14 C	M1.2 ■ 12 C	M2.1 ■ 12 C	M2.2 ■ 10 B	K1.1 ■ 25 C	K1.2 ■ 19 C
K1.3 ■ 14 C	K2.1 ■ 49 C	K2.2 ■ 40 C	K2.3 ■ 32 B	K3.1 ■ 44 C	K3.2 ■ 33 C	K3.3 ■ 27 A	K4.1 ■ 40 B	K4.2 ■ 30 B	K4.3 ■ 22 B	K4.4 ■ 19 A	K4.5 ■ 16 A	K5.1 ■ 46 B	K5.2 ■ 34 B
K5.3 ■ 27 B	N1.1 ■ 81 E	N1.2 ■ 60 D	N1.3 ■ 41 D	N2.1 ■ 41 C	N2.2 ■ 37 C	N2.3 ■ 26 C	N3.1 ■ 43 C	N3.2 ■ 25 C	N3.3 ■ 13 C	N4.1 ■ 43 C	S1.1 ■ 25 B	S1.2 ■ 20 B	S2.1 ■ 13 A
S3.1 ■ 10 A	S4.1 ■ 8 A												

DCON MS tolerance h6.

Product	DC [inch]	DC [mm]	DCON MS [mm]	APMX [mm]	OAL [mm]	NOF	LU [mm]	DN [mm]
C2732.0	–	2.00	6.00	10.00	54.0	4	–	–
C2732.5	–	2.50	6.00	12.00	56.0	4	–	–
C2733.0	–	3.00	6.00	12.00	56.0	4	–	–
C2731/8 ²⁾	1/8	3.18	6.00	15.00	59.0	4	–	–
C2733.5	–	3.50	6.00	15.00	59.0	4	–	–
C2734.0	–	4.00	6.00	19.00	63.0	4	–	–
C2734.5	–	4.50	6.00	19.00	63.0	4	–	–
C2733/16 ²⁾	3/16	4.76	6.00	24.00	68.0	4	–	–
C2735.0	–	5.00	6.00	24.00	68.0	4	–	–
C2735.5	–	5.50	6.00	24.00	68.0	4	–	–
C2736.0	–	6.00	6.00	24.00	68.0	4	–	–
C2731/4 ²⁾	1/4	6.35	10.00	30.00	80.0	4	–	–
C2737.0	–	7.00	10.00	30.00	80.0	4	–	–
C2738.0	–	8.00	10.00	38.00	88.0	4	–	–
C2739.0	–	9.00	10.00	38.00	88.0	4	–	–
C2733/8 ²⁾	3/8	9.52	10.00	45.00	95.0	4	54.50	9.50
C27310.0	–	10.00	10.00	45.00	95.0	4	54.50	9.50
C27311.0	–	11.00	12.00	45.00	102.0	4	–	–
C27312.0	–	12.00	12.00	53.00	110.0	4	64.50	11.50
C2731/2 ²⁾	1/2	12.70	12.00	53.00	110.0	4	64.50	11.50
C27313.0	–	13.00	12.00	53.00	110.0	4	64.50	11.50
C27314.0	–	14.00	12.00	53.00	110.0	4	64.50	11.50
C27315.0	–	15.00	12.00	53.00	110.0	4	64.50	11.50
C2735/8 ²⁾	5/8	15.88	16.00	63.00	123.0	4	74.50	15.50
C27316.0	–	16.00	16.00	63.00	123.0	4	74.50	15.50



Product	DC	DC	DCON MS	APMX	OAL	NOF	LU	DN
	[inch]	[mm]	[mm]	[mm]	[mm]		[mm]	[mm]
C27318.0	–	18.00	16.00	63.00	123.0	4	74.50	15.50
C2733/4 ²⁾	3/4	19.05	20.00	75.00	141.0	4	90.50	18.50
C27320.0	–	20.00	20.00	75.00	141.0	4	90.50	19.50
C27322.0	–	22.00	20.00	75.00	141.0	5	90.50	19.50
C27325.0	–	25.00	25.00	90.00	166.0	5	109.50	24.50
C2731 ²⁾	1"	25.40	25.00	90.00	166.0	5	109.50	24.50
C27328.0	–	28.00	25.00	90.00	166.0	6	109.50	24.50
C27330.0	–	30.00	25.00	90.00	166.0	6	109.50	24.50
C27332.0	–	32.00	32.00	106.00	186.0	6	125.50	31.50
C27340.0 ¹⁾	–	40.00	40.00	125.00	217.0	6	146.50	39.00

¹⁾ Available in HSS-E only; no centre cutting.

²⁾ DC tolerance +0.0025 inches / -0.0005 inches.



C295



Multi-Flute HSS-E-PM Long Series End Mill, TiCN Coating

Long cut length, 4, 5 or 6 flute design provides high rigidity for finishing deep profiles. TiCN coating increases the life of the cutter and improves performance when milling hard and abrasive materials.

HSS-E PM	N	NOF 4-6
	λ 30°	γ 12°
	TiCN	DC k10
	DIN 844L	

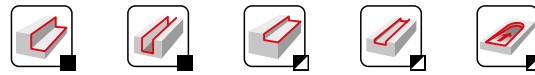
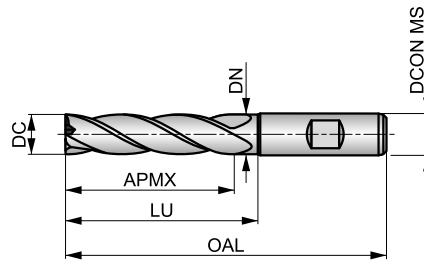

Workpiece material group suitability, starting values for cutting speed (m/min) and Alpha Code. Tables with feed per tooth and correction factors can be found starting from page 194.

P1.1 ■ 99 C	P1.2 ■ 111 C	P1.3 ■ 115 C	P2.1 ■ 85 C	P2.2 ■ 75 C	P2.3 ■ 66 B	P3.1 ■ 66 C	P3.2 ■ 53 B	P3.3 ■ 45 B	P4.1 ■ 40 B	P4.2 ■ 34 B	P4.3 ■ 27 B	M1.1 ■ 55 C	M1.2 ■ 46 C
M2.1 ■ 49 C	M2.2 ■ 40 B	M3.3 ■ 21 A	M4.1 ■ 20 A	K1.1 ■ 50 C	K1.2 ■ 37 C	K1.3 ■ 28 C	K2.1 ■ 86 C	K2.2 ■ 70 C	K2.3 ■ 56 B	K3.1 ■ 76 C	K3.2 ■ 58 C	K3.3 ■ 47 A	K4.1 ■ 71 B
K4.2 ■ 53 B	K4.3 ■ 39 B	K4.4 ■ 33 A	K4.5 ■ 28 A	K5.1 ■ 80 B	K5.2 ■ 60 B	K5.3 ■ 46 B	N1.1 ■ 139 E	N1.2 ■ 105 D	N1.3 ■ 70 D	N2.1 ■ 70 C	N2.2 ■ 63 C	N2.3 ■ 45 C	N3.1 ■ 73 C
N3.2 ■ 43 C	N3.3 ■ 22 C	N4.1 ■ 73 C	S1.1 ■ 40 B	S1.2 ■ 30 B	S1.3 ■ 15 A	S2.1 ■ 27 A	S2.2 ■ 14 A	S3.1 ■ 20 A	S3.2 ■ 10 A	S4.1 ■ 16 A	S4.2 ■ 8 A		

DCON MS tolerance h6.

Product	DC [mm]	DCON MS [mm]	APMX [mm]	OAL [mm]	NOF	LU [mm]	DN [mm]
C2952.0	2.00	6.00	10.00	54.0	4	-	-
C2953.0	3.00	6.00	12.00	56.0	4	-	-
C2954.0	4.00	6.00	19.00	63.0	4	-	-
C2955.0	5.00	6.00	24.00	68.0	4	-	-
C2956.0	6.00	6.00	24.00	68.0	4	-	-
C2957.0	7.00	10.00	30.00	80.0	4	-	-
C2958.0	8.00	10.00	38.00	88.0	4	-	-
C2959.0	9.00	10.00	38.00	88.0	4	-	-
C29510.0	10.00	10.00	45.00	95.0	4	54.50	9.50
C29511.0	11.00	12.00	45.00	102.0	4	-	-
C29512.0	12.00	12.00	53.00	110.0	4	64.50	11.50
C29515.0	15.00	12.00	53.00	110.0	4	64.50	11.50
C29516.0	16.00	16.00	63.00	123.0	4	74.50	15.50
C29518.0	18.00	16.00	63.00	123.0	4	74.50	15.50
C29520.0	20.00	20.00	75.00	141.0	4	90.50	19.50
C29525.0	25.00	25.00	90.00	166.0	5	109.50	24.50
C29530.0	30.00	25.00	90.00	166.0	6	109.50	24.50
C29532.0	32.00	32.00	106.00	186.0	6	125.50	31.50
C29540.0 ¹⁾	40.00	40.00	125.00	217.0	6	146.50	39.00

¹⁾ Available in HSS-E only; no centre cutting.



C333



3-Flute HSS-E-PM Long Series End Mill, Bright Finish

Long cut length, 3-flute with a 40° helix designed for machining softer materials. The long series flute provides high rigidity for machining deep slots and profiles. Neck recess to avoid work contact with the wall and extend reach. Designed specifically for milling non-ferrous materials.

HSS-E PM	W	NOF 3
	λ 40°	γ 25°
DIN 1835B	Bright	DC k10
	DIN 844L	

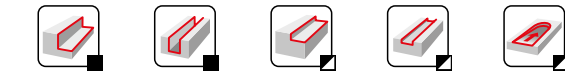
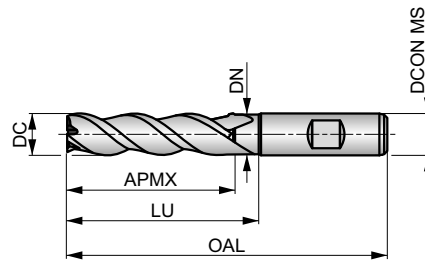

Workpiece material group suitability, starting values for cutting speed (m/min) and Alpha Code. Tables with feed per tooth and correction factors can be found starting from page 194.

N1.1 ■ 114 E	N1.2 ■ 86 D	N1.3 ■ 58 D	N2.1 ■ 58 C	N2.2 ■ 51 C	N2.3 ■ 37 C	N3.1 ■ 60 C	N3.2 ■ 35 C	N3.3 ■ 18 C	N4.1 ■ 60 C	N4.2 ■ 23 C
------------------------	-----------------------	-----------------------	-----------------------	-----------------------	-----------------------	-----------------------	-----------------------	-----------------------	-----------------------	-----------------------

DCON MS tolerance h6.

Product	DC [mm]	DCON MS [mm]	APMX [mm]	OAL [mm]	NOF	LU [mm]	DN [mm]
C33310.0	10.00	10.00	45.00	95.0	3	54.50	9.50
C33312.0	12.00	12.00	53.00	110.0	3	64.50	11.50
C33314.0	14.00	12.00	53.00	110.0	3	64.50	11.50
C33316.0	16.00	16.00	63.00	123.0	3	74.50	15.50
C33318.0	18.00	16.00	63.00	123.0	3	74.50	15.50
C33320.0	20.00	20.00	75.00	141.0	3	90.50	19.50
C33325.0	25.00	25.00	90.00	166.0	3	109.50	24.50
C33330.0	30.00	25.00	90.00	166.0	3	109.50	24.50



C922



3-4 Flute HSS-E-PM Roughing End Mill, Alcrona Coating

Short cut length, 3 or 4 flute design with neck recess on big cutting diameter sizes and an HRA profile to break up the chips for efficient roughing application. A 35° helix reduces vibration and improves performance. Alcrona coating improves performance and extends the tool life.

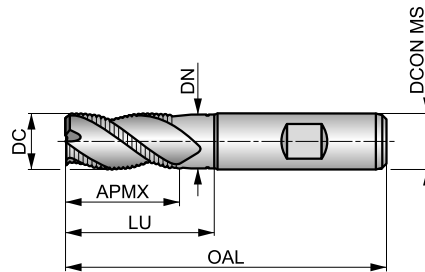

HSS-E PM	HRA	NOF 3-4
	λ 35°	γ 12°
		DC k12
	DIN 844K	

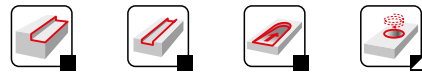

Workpiece material group suitability, starting values for cutting speed (m/min) and Alpha Code. Tables with feed per tooth and correction factors can be found starting from page 194.

P2.2 ■ 95 F	P2.3 ■ 84 E	P3.1 ■ 81 F	P3.2 ■ 65 E	P3.3 ■ 55 E	P4.1 ■ 48 E	P4.2 ■ 41 E	P4.3 ■ 34 E	M1.1 ■ 69 F	M1.2 ■ 58 F	M2.1 ■ 61 F	M2.2 ■ 50 E	M3.1 ■ 47 E	M3.2 ■ 40 E
M3.3 ■ 36 D	M4.1 ■ 25 D	K1.1 ■ 60 F	K1.2 ■ 44 F	K1.3 ■ 33 F	K2.1 ■ 111 F	K2.2 ■ 90 F	K2.3 ■ 72 E	K3.1 ■ 98 F	K3.2 ■ 75 F	K3.3 ■ 61 E	K4.1 ■ 91 E	K4.2 ■ 68 E	K4.3 ■ 50 E
K4.4 ■ 43 D	K4.5 ■ 36 D	K5.1 ■ 103 E	K5.2 ■ 77 E	K5.3 ■ 60 E	N3.1 ■ 93 F	N3.2 ■ 55 F	S1.1 ■ 45 E	S1.2 ■ 35 E	S1.3 ■ 15 D	S2.1 ■ 33 D	S2.2 ■ 14 D	S3.1 ■ 25 D	S3.2 ■ 10 D
S4.1 ■ 20 D	S4.2 ■ 8 D												

DCON MS tolerance h6.

Product	DC	DCON MS	APMX	OAL	NOF	LU	DN
	[mm]	[mm]	[mm]	[mm]		[mm]	[mm]
C9226.0	6.00	6.00	13.00	57.0	3	–	–
C9227.0	7.00	10.00	16.00	66.0	3	–	–
C9228.0	8.00	10.00	19.00	69.0	3	–	–
C9229.0	9.00	10.00	19.00	69.0	3	–	–
C92210.0	10.00	10.00	22.00	72.0	3	31.50	9.50
C92211.0	11.00	12.00	22.00	79.0	3	–	–
C92212.0	12.00	12.00	26.00	83.0	3	37.50	11.50
C92213.0	13.00	12.00	26.00	83.0	3	37.50	11.50
C92214.0	14.00	12.00	26.00	83.0	3	37.50	11.50
C92215.0	15.00	12.00	26.00	83.0	3	37.50	11.50
C92216.0	16.00	16.00	32.00	92.0	3	43.50	15.50
C92218.0	18.00	16.00	32.00	92.0	3	43.50	15.50
C92220.0	20.00	20.00	38.00	104.0	3	53.50	19.50
C92222.0	22.00	20.00	38.00	104.0	3	53.50	19.50
C92224.0	24.00	25.00	45.00	121.0	4	64.50	23.50
C92225.0	25.00	25.00	45.00	121.0	4	64.50	24.50
C92228.0	28.00	25.00	45.00	121.0	4	64.50	24.50
C92232.0	32.00	32.00	53.00	133.0	4	72.50	31.50



C428



Multi-Flute HSS-E-PM Roughing End Mill, Alcrona Coating

Short cut length, 4 or 6 flute design with neck recess on big cutting diameter sizes and an HRA profile to break chips for efficient roughing application. A 35° helix reduces vibration and improves performance. Alcrona coating improves performance and extends the tool life.

HSS-E PM	HRA	NOF 4-6
	λ 35°	γ 12°
DIN 1835B	Alcrona	DC k12
	DIN 844K	

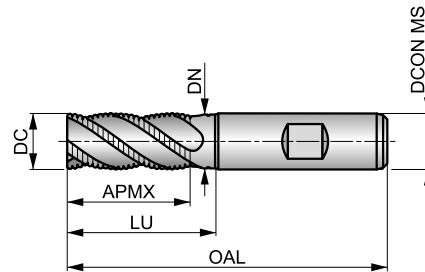

Workpiece material group suitability, starting values for cutting speed (m/min) and Alpha Code. Tables with feed per tooth and correction factors can be found starting from page 194.

P2.2 ■ 93 F	P2.3 ■ 82 E	P3.1 ■ 80 F	P3.2 ■ 64 E	P3.3 ■ 54 E	P4.1 ■ 48 E	P4.2 ■ 40 E	P4.3 ■ 33 E	M1.1 ■ 66 F	M1.2 ■ 56 F	M2.1 ■ 59 F	M2.2 ■ 48 E	M3.1 ■ 47 E	M3.2 ■ 40 E
M3.3 ■ 36 D	M4.1 ■ 26 D	K1.1 ■ 61 F	K1.2 ■ 45 F	K1.3 ■ 34 F	K2.1 ■ 108 F	K2.2 ■ 88 F	K2.3 ■ 70 E	K3.1 ■ 96 F	K3.2 ■ 73 F	K3.3 ■ 59 E	K4.1 ■ 89 E	K4.2 ■ 67 E	K4.3 ■ 49 E
K4.4 ■ 42 D	K4.5 ■ 35 D	K5.1 ■ 100 E	K5.2 ■ 76 E	K5.3 ■ 58 E	N3.1 ■ 116 F	N3.2 ■ 68 F	S1.1 ■ 146 E	S1.2 ■ 37 E	S1.3 ■ 16 D	S2.1 ■ 36 D	S2.2 ■ 16 D	S3.1 ■ 27 D	S3.2 ■ 11 D
S4.1 ■ 21 D	S4.2 ■ 9 D												

DCON MS tolerance h6.

Product	DC [mm]	DCON MS [mm]	APMX [mm]	OAL [mm]	NOF	LU [mm]	DN [mm]
C4286.0	6.00	6.00	13.00	57.0	4	–	–
C4287.0	7.00	10.00	16.00	66.0	4	–	–
C4288.0	8.00	10.00	19.00	69.0	4	–	–
C4289.0	9.00	10.00	19.00	69.0	4	–	–
C42810.0	10.00	10.00	22.00	72.0	4	31.50	9.50
C42811.0	11.00	12.00	22.00	79.0	4	–	–
C42812.0	12.00	12.00	26.00	83.0	4	37.50	11.50
C42813.0	13.00	12.00	26.00	83.0	4	37.50	11.50
C42814.0	14.00	12.00	26.00	83.0	4	37.50	11.50
C42815.0	15.00	12.00	26.00	83.0	4	37.50	11.50
C42816.0	16.00	16.00	32.00	92.0	4	43.50	15.50
C42818.0	18.00	16.00	32.00	92.0	4	43.50	15.50
C42820.0	20.00	20.00	38.00	104.0	4	53.50	19.50
C42822.0	22.00	20.00	38.00	104.0	4	53.50	19.50
C42825.0	25.00	25.00	45.00	121.0	6	64.50	24.50
C42828.0	28.00	25.00	45.00	121.0	6	64.50	24.50
C42830.0	30.00	25.00	45.00	121.0	6	64.50	24.50
C42832.0	32.00	32.00	53.00	133.0	6	72.50	31.50
C42836.0	36.00	32.00	53.00	133.0	6	72.50	31.00
C42840.0	40.00	40.00	63.00	155.0	6	84.50	39.00



C492



Multi-Flute HSS-E-PM Long Series Roughing End Mill, Alcrona Coating

Long cut length, 3, 4 or 6 flute design with an HRA profile to break chips for efficient roughing of deep profiles. Neck recess on cutting diameter equal to 10 mm and above. A 35° helix reduces vibration and improves performance when roughing. Alcrona coating improves performance and extends tool life.

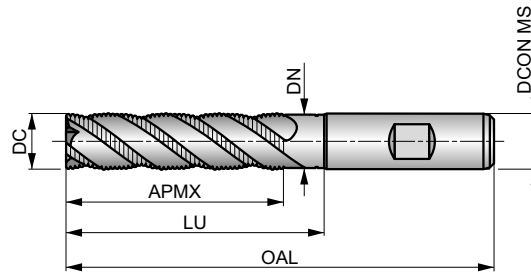

HSS-E PM	HRA	NOF 3-6
	λ 35°	γ 12°
DIN 1835B	Alcrona	DC k12
	DIN 844L	

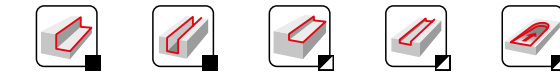

Workpiece material group suitability, starting values for cutting speed (m/min) and Alpha Code. Tables with feed per tooth and correction factors can be found starting from page 194.

P2.2 ■ 83 E	P2.3 ■ 73 D	P3.1 ■ 72 E	P3.2 ■ 58 D	P3.3 ■ 49 D	P4.1 ■ 43 D	P4.2 ■ 37 D	P4.3 ■ 30 D	M1.1 ■ 59 E	M1.2 ■ 50 E	M2.1 ■ 53 E	M2.2 ■ 43 D	M3.1 ■ 42 D	M3.2 ■ 36 D
M3.3 ■ 32 C	M4.1 ■ 23 C	K1.1 ■ 55 E	K1.2 ■ 41 E	K1.3 ■ 31 E	K2.1 ■ 97 E	K2.2 ■ 79 E	K2.3 ■ 63 D	K3.1 ■ 86 E	K3.2 ■ 66 E	K3.3 ■ 53 D	K4.1 ■ 80 D	K4.2 ■ 60 D	K4.3 ■ 44 D
K4.4 ■ 38 C	K4.5 ■ 31 C	K5.1 ■ 90 D	K5.2 ■ 68 D	K5.3 ■ 52 D	N3.1 ■ 104 E	N3.2 ■ 61 E	S1.1 ■ 41 D	S1.2 ■ 34 D	S1.3 ■ 15 C	S2.1 ■ 32 C	S2.2 ■ 14 C	S3.1 ■ 24 C	S3.2 ■ 10 C
S4.1 ■ 19 C	S4.2 ■ 8 C												

DCON MS tolerance h6.

Product	DC	DCON MS	APMX	OAL	NOF	LU	DN
	[mm]	[mm]	[mm]	[mm]		[mm]	[mm]
C4926.0	6.00	6.00	24.00	68.0	3	–	–
C4928.0	8.00	10.00	38.00	88.0	3	–	–
C49210.0	10.00	10.00	45.00	95.0	4	54.50	9.50
C49212.0	12.00	12.00	53.00	110.0	4	64.50	11.50
C49214.0	14.00	12.00	53.00	110.0	4	64.50	11.50
C49216.0	16.00	16.00	63.00	123.0	4	74.50	15.50
C49218.0	18.00	16.00	63.00	123.0	4	74.50	15.50
C49220.0	20.00	20.00	75.00	141.0	4	90.50	19.50
C49222.0	22.00	20.00	75.00	141.0	4	90.50	19.50
C49225.0	25.00	25.00	90.00	166.0	6	109.50	24.50
C49230.0	30.00	25.00	90.00	166.0	6	109.50	24.50



C407



4-Flute HSS-E-PM Roughing End Mill, Bright Finish

Short cut length, 4-flute design with neck recess on big cutting diameter sizes and an NRA profile to break chips for efficient roughing applications. A 35° helix reduces vibration and improves performance in roughing operations.

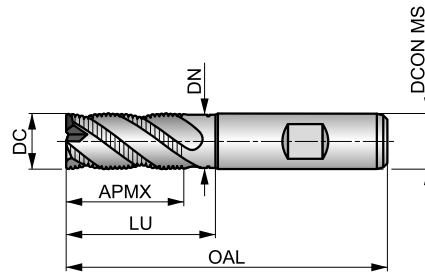

HSS-E PM	NRA	NOF 4
	λ 35°	γ 12°
	Bright	DC k12
	DIN 844K	



Workpiece material group suitability, starting values for cutting speed (m/min) and Alpha Code. Tables with feed per tooth and correction factors can be found starting from page 194.

P1.1 ■ 50 G	P1.2 ■ 56 G	P1.3 ■ 58 G	P2.1 ■ 43 G	P2.2 ■ 38 G	P2.3 ■ 34 F	P3.1 ■ 32 G	P3.2 ■ 26 F	P3.3 ■ 22 F	P4.1 ■ 19 F	P4.2 ■ 16 F	P4.3 ▣ 13 F	M1.1 ■ 34 G	M1.2 ■ 29 G
M2.1 ■ 31 G	M2.2 ■ 25 F	M3.1 ▣ 24 F	M3.2 ▣ 21 F	M3.3 ■ 19 E	M4.1 ■ 13 E	K1.1 ■ 30 G	K1.2 ■ 22 G	K1.3 ■ 17 G	K2.1 ■ 54 G	K2.2 ■ 44 G	K2.3 ■ 35 F	K3.1 ■ 48 G	K3.2 ■ 37 G
K3.3 ■ 30 F	K4.1 ■ 44 F	K4.2 ■ 33 F	K4.3 ■ 25 F	K4.4 ■ 21 E	K4.5 ■ 18 E	K5.1 ■ 50 F	K5.2 ■ 38 F	K5.3 ■ 29 F	N3.1 ■ 43 G	N3.2 ■ 25 G	S1.1 ▣ 30 F	S1.2 ■ 25 F	S1.3 ■ 11 E
S2.1 ■ 19 E	S2.2 ■ 8 E	S3.1 ■ 14 E	S3.2 ■ 6 E	S4.1 ■ 11 E	S4.2 ■ 5 E								

DCON MS tolerance h6.

Product	DC [mm]	DCON MS [mm]	APMX [mm]	OAL [mm]	NOF	LU [mm]	DN [mm]
C4076.0	6.00	6.00	13.00	57.0	4	–	–
C4077.0	7.00	10.00	16.00	66.0	4	–	–
C4078.0	8.00	10.00	19.00	69.0	4	–	–
C4079.0	9.00	10.00	19.00	69.0	4	–	–
C40710.0	10.00	10.00	22.00	72.0	4	31.50	9.50
C40711.0	11.00	12.00	22.00	79.0	4	–	–
C40712.0	12.00	12.00	26.00	83.0	4	37.50	11.50
C40713.0	13.00	12.00	26.00	83.0	4	37.50	11.50
C40714.0	14.00	12.00	26.00	83.0	4	37.50	11.50
C40715.0	15.00	12.00	26.00	83.0	4	37.50	11.50
C40716.0	16.00	16.00	32.00	92.0	4	43.50	15.50
C40718.0	18.00	16.00	32.00	92.0	4	43.50	15.50
C40720.0	20.00	20.00	38.00	104.0	4	53.50	19.50



C908



Multi-Flute HSS-E-PM Roughing End Mill, Alcrona Coating

Short cut length, 4 or 6 flute design with neck recess on big cutting diameter sizes and an NRA profile to break chips for efficient roughing application. A 35° helix reduces vibration and improves performance in roughing operations. Alcrona coating improves performance and extends the tool life.

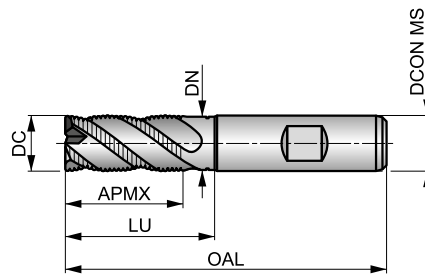

HSS-E PM	NRA	NOF 4-6
	λ 35°	γ 12°
	Alcrona	DC k12
	DIN 844K	



Workpiece material group suitability, starting values for cutting speed (m/min) and Alpha Code. Tables with feed per tooth and correction factors can be found starting from page 194.

P2.2 ■ 93 G	P2.3 ■ 82 F	P3.1 ■ 80 G	P3.2 ■ 64 F	P3.3 ■ 54 F	P4.1 ■ 48 F	P4.2 ■ 40 F	P4.3 □ 33 F	M1.1 ■ 66 G	M1.2 ■ 56 G	M2.1 ■ 59 G	M2.2 ■ 48 F	M3.1 ■ 47 F	M3.2 ■ 40 F
M3.3 ■ 36 E	M4.1 ■ 26 E	K1.1 ■ 61 G	K1.2 ■ 45 G	K1.3 ■ 34 G	K2.1 ■ 108 G	K2.2 ■ 88 G	K2.3 ■ 70 F	K3.1 ■ 96 G	K3.2 ■ 73 G	K3.3 ■ 59 F	K4.1 ■ 89 F	K4.2 ■ 67 F	K4.3 ■ 49 F
K4.4 ■ 42 E	K4.5 ■ 35 E	K5.1 ■ 100 F	K5.2 ■ 76 F	K5.3 ■ 58 F	N3.1 ■ 93 G	N3.2 ■ 55 G	S1.1 □ 46 F	S1.2 ■ 37 F	S1.3 ■ 16 E	S2.1 ■ 36 E	S2.2 ■ 16 E	S3.1 ■ 27 E	S3.2 ■ 11 E
S4.1 ■ 21 E	S4.2 ■ 9 E												

DCON MS tolerance h6.

Product	DC	DCON MS	APMX	OAL	NOF	LU	DN
	[mm]	[mm]	[mm]	[mm]		[mm]	[mm]
C9086.0	6.00	6.00	13.00	57.0	4	–	–
C9087.0	7.00	10.00	16.00	66.0	4	–	–
C9088.0	8.00	10.00	19.00	69.0	4	–	–
C9089.0	9.00	10.00	19.00	69.0	4	–	–
C90810.0	10.00	10.00	22.00	72.0	4	31.50	9.50
C90811.0	11.00	12.00	22.00	79.0	4	–	–
C90812.0	12.00	12.00	26.00	83.0	4	37.50	11.50
C90813.0	13.00	12.00	26.00	83.0	4	37.50	11.50
C90814.0	14.00	12.00	26.00	83.0	4	37.50	11.50
C90815.0	15.00	12.00	26.00	83.0	4	37.50	11.50
C90816.0	16.00	16.00	32.00	92.0	4	43.50	15.50
C90818.0	18.00	16.00	32.00	92.0	4	43.50	15.50
C90820.0	20.00	20.00	38.00	104.0	4	53.50	19.50
C90822.0	22.00	20.00	38.00	104.0	4	53.50	19.50
C90825.0	25.00	25.00	45.00	121.0	6	64.50	24.50
C90830.0	30.00	25.00	45.00	121.0	6	64.50	24.50
C90832.0	32.00	32.00	53.00	133.0	6	72.50	31.50



C948



Multi-Flute HSS-E-PM Long Series Roughing End Mill, Alcrona Coating

Long cut length, 4 or 6 flute design with an NRA profile to break chips for efficient roughing of deep profiles. A 35° helix reduces vibration and improves performance in roughing operations. Neck recess on cutting diameter equal to 10 mm and above. Alcrona coating improves performance and extends tool life.

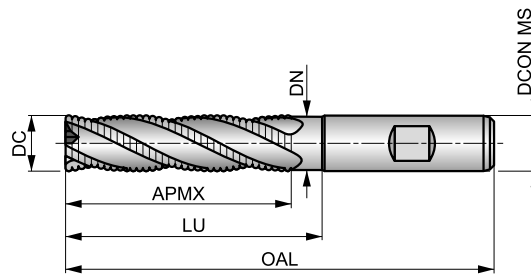

HSS-E PM	NRA	NOF 4-6
	λ 35°	γ 12°
DIN 1835B	Alcrona	DC k12
	DIN 844L	

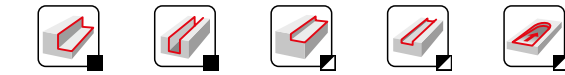

Workpiece material group suitability, starting values for cutting speed (m/min) and Alpha Code. Tables with feed per tooth and correction factors can be found starting from page 194.

P2.2 ■ 83 F	P2.3 ■ 73 E	P3.1 ■ 72 F	P3.2 ■ 58 E	P3.3 ■ 49 E	P4.1 ■ 43 E	P4.2 ■ 37 E	P4.3 ■ 30 E	M1.1 ■ 59 F	M1.2 ■ 50 F	M2.1 ■ 53 F	M2.2 ■ 43 E	M3.1 ■ 42 E	M3.2 ■ 36 E
M3.3 ■ 32 D	M4.1 ■ 23 D	K1.1 ■ 55 F	K1.2 ■ 41 F	K1.3 ■ 31 F	K2.1 ■ 97 F	K2.2 ■ 79 F	K2.3 ■ 63 E	K3.1 ■ 86 F	K3.2 ■ 66 F	K3.3 ■ 53 E	K4.1 ■ 80 E	K4.2 ■ 60 E	K4.3 ■ 44 E
K4.4 ■ 38 D	K4.5 ■ 31 D	K5.1 ■ 90 E	K5.2 ■ 68 E	K5.3 ■ 52 E	N3.1 ■ 83 F	N3.2 ■ 49 F	S1.1 ■ 41 E	S1.2 ■ 34 E	S1.3 ■ 15 D	S2.1 ■ 32 D	S2.2 ■ 14 D	S3.1 ■ 24 D	S3.2 ■ 10 D
S4.1 ■ 19 D	S4.2 ■ 8 D												

DCON MS tolerance h6.

Product	DC [mm]	DCON MS [mm]	APMX [mm]	OAL [mm]	NOF	LU [mm]	DN [mm]
C9486.0	6.00	6.00	24.00	68.0	4	–	–
C9488.0	8.00	10.00	38.00	88.0	4	–	–
C94810.0	10.00	10.00	45.00	95.0	4	54.50	9.50
C94812.0	12.00	12.00	53.00	110.0	4	64.50	11.50
C94814.0	14.00	12.00	53.00	110.0	4	64.50	11.50
C94816.0	16.00	16.00	63.00	123.0	4	74.50	15.50
C94818.0	18.00	16.00	63.00	123.0	4	74.50	15.50
C94820.0	20.00	20.00	75.00	141.0	4	90.50	19.50
C94825.0	25.00	25.00	90.00	166.0	6	109.50	24.50
C94830.0	30.00	25.00	90.00	166.0	6	109.50	24.50
C94832.0	32.00	32.00	106.00	186.0	6	125.50	31.50



C400



4-Flute HSS-E Roughing End Mill, Bright Finish

Short cut length, 4-flute design without center cut, for peripheral roughing operations only. The NF profile breaks chips for an efficient roughing operation. A 30° helix reduces vibrations and improves performance when roughing mild materials.

HSS-E	NF	NOF 4
	λ 30°	γ 12°
DIN 1835B	Bright	DC k12
	DIN 844K	

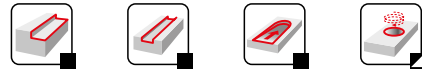
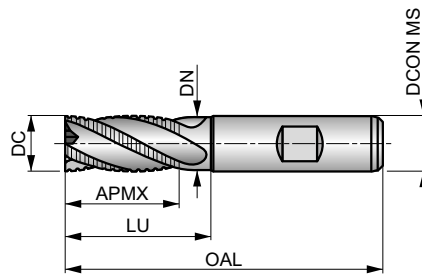

Workpiece material group suitability, starting values for cutting speed (m/min) and Alpha Code. Tables with feed per tooth and correction factors can be found starting from page 194.

P1.1 ■ 46 E	P1.2 ■ 52 E	P1.3 ■ 54 E	P2.1 ■ 40 E	P2.2 ■ 35 E	P3.1 ■ 32 E	P3.2 ■ 26 D	P4.1 ■ 19 D	M1.1 ■ 34 E	M1.2 ■ 29 E	M2.1 ■ 31 E	M2.2 ■ 25 D	K1.1 ■ 30 E	K1.2 ■ 22 E
K1.3 ■ 17 E	K2.1 ■ 49 E	K2.2 ■ 40 E	K2.3 ■ 32 D	K3.1 ■ 44 E	K3.2 ■ 33 E	K3.3 ■ 27 D	K4.1 ■ 40 D	K4.2 ■ 30 D	K4.3 ■ 22 D	K4.4 ■ 19 C	K4.5 ■ 16 C	K5.1 ■ 46 D	K5.2 ■ 34 D
K5.3 ■ 27 D	N1.3 ■ 41 F	N2.1 ■ 41 E	N2.2 ■ 37 E	N2.3 ■ 26 E	N3.1 ■ 43 E	N3.2 ■ 25 E	N3.3 ■ 13 E	N4.1 ■ 43 E	S1.1 ■ 30 D	S1.2 ■ 25 D	S2.1 ■ 20 C	S3.1 ■ 15 C	S4.1 ■ 12 C

DCON MS tolerance h6.

Product	DC [mm]	DCON MS [mm]	APMX [mm]	OAL [mm]	NOF	LU [mm]	DN [mm]
C4006.0	6.00	6.00	13.00	57.0	4	–	–
C4008.0	8.00	10.00	19.00	69.0	4	–	–
C40010.0	10.00	10.00	22.00	72.0	4	–	–
C40012.0	12.00	12.00	26.00	83.0	4	–	–
C40014.0	14.00	12.00	26.00	83.0	4	37.50	11.50
C40016.0	16.00	16.00	32.00	92.0	4	43.50	15.50
C40018.0	18.00	16.00	32.00	92.0	4	43.50	15.50
C40020.0	20.00	20.00	38.00	104.0	4	53.50	19.50



C413

4-Flute HSS-E Roughing End Mill, TiCN Coating

Short cut length, 4-flute design for peripheral roughing operations only. The NF profile breaks chips for an efficient roughing application. A 30° helix reduces vibrations and improves performance in roughing. TiCN coating increases the life of the cutter and improves performance when milling hard and abrasive materials.

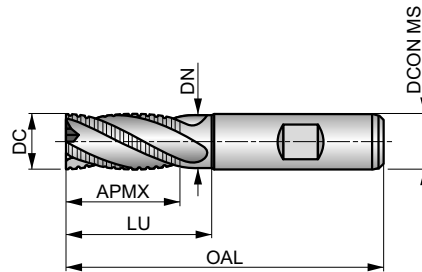

HSS-E	NF	NOF 4
	λ 30°	γ 12°
DIN 1835B	TiCN	DC k12
	DIN 844K	



Workpiece material group suitability, starting values for cutting speed (m/min) and Alpha Code. Tables with feed per tooth and correction factors can be found starting from page 194.

P1.1 ■ 93 E	P1.2 ■ 104 E	P1.3 ■ 108 E	P2.1 ■ 80 E	P2.2 ■ 70 E	P2.3 ▧ 62 D	P3.1 ■ 59 E	P3.2 ■ 47 D	P3.3 ▧ 40 D	P4.1 ■ 35 D	P4.2 ▧ 30 D	P4.3 ▧ 24 D	M1.1 ▧ 48 E	M1.2 ▧ 41 E
M2.1 ▧ 43 E	M2.2 ▧ 35 D	M3.3 ▧ 21 C	M4.1 ▧ 20 C	K1.1 ■ 45 E	K1.2 ■ 33 E	K1.3 ■ 25 E	K2.1 ■ 80 E	K2.2 ■ 65 E	K2.3 ■ 52 D	K3.1 ■ 71 E	K3.2 ■ 54 E	K3.3 ■ 44 D	K4.1 ■ 66 D
K4.2 ■ 49 D	K4.3 ■ 36 D	K4.4 ■ 31 C	K4.5 ■ 26 C	K5.1 ■ 74 D	K5.2 ■ 56 D	K5.3 ■ 43 D	N1.3 ▧ 182 F	N2.1 ▧ 82 E	N2.2 ■ 74 E	N2.3 ■ 52 E	N3.1 ■ 86 E	N3.2 ■ 50 E	N3.3 ▧ 26 E
N4.1 ▧ 186 E	S1.1 ▧ 35 D	S1.2 ■ 30 D	S1.3 ▧ 10 C	S2.1 ■ 27 C	S2.2 ▧ 14 C	S3.1 ■ 20 C	S3.2 ▧ 10 C	S4.1 ■ 16 C	S4.2 ▧ 18 C				

DCON MS tolerance h6.

Product	DC [mm]	DCON MS [mm]	APMX [mm]	OAL [mm]	NOF	LU [mm]	DN [mm]
C4136.0	6.00	6.00	13.00	57.0	4	–	–
C4138.0	8.00	10.00	19.00	69.0	4	–	–
C41310.0	10.00	10.00	22.00	72.0	4	–	–
C41312.0	12.00	12.00	26.00	83.0	4	–	–
C41314.0	14.00	12.00	26.00	83.0	4	37.50	11.50
C41316.0	16.00	16.00	32.00	92.0	4	43.50	15.50
C41318.0	18.00	16.00	32.00	92.0	4	43.50	15.50
C41320.0	20.00	20.00	38.00	104.0	4	53.50	19.50



C403



Multi-Flute HSS-E Long Series Roughing End Mill, Bright Finish

Long cut length, 4, 5 or 6 flute design with no center cut for peripheral roughing operations only. The NF profile breaks chips for an efficient roughing operation. A 30° helix reduces vibrations and improves performance when roughing mild materials. Neck recess on cutting diameter equal to 14 mm and above.

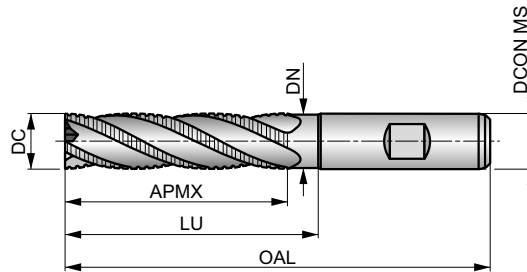

HSS-E	NF	NOF 4-6
	λ 30°	γ 12°
DIN 1835B	Bright	DC k12
	DIN 844L	

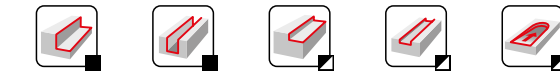

Workpiece material group suitability, starting values for cutting speed (m/min) and Alpha Code. Tables with feed per tooth and correction factors can be found starting from page 194.

P1.1 ■ 40 D	P1.2 ■ 45 D	P1.3 ■ 46 D	P2.1 ■ 34 D	P2.2 ■ 30 D	P3.1 ■ 28 D	P3.2 ■ 22 C	P4.1 ■ 16 C	M1.1 ■ 27 D	M1.2 ■ 23 D	M2.1 ■ 24 D	M2.2 ■ 20 C	K1.1 ■ 25 D	K1.2 ■ 19 D
K1.3 ■ 14 D	K2.1 ■ 43 D	K2.2 ■ 35 D	K2.3 ■ 28 C	K3.1 ■ 38 D	K3.2 ■ 29 D	K3.3 ■ 24 B	K4.1 ■ 35 C	K4.2 ■ 27 C	K4.3 ■ 20 C	K4.4 ■ 17 B	K4.5 ■ 14 B	K5.1 ■ 40 C	K5.2 ■ 30 C
K5.3 ■ 23 C	N1.3 ■ 38 E	N2.1 ■ 38 D	N2.2 ■ 34 D	N2.3 ■ 25 D	N3.1 ■ 40 D	N3.2 ■ 23 D	N3.3 ■ 12 D	N4.1 ■ 40 D	S1.1 ■ 25 C	S1.2 ■ 20 C	S2.1 ■ 13 B	S3.1 ■ 10 B	S4.1 ■ 8 B

DCON MS tolerance h6.

Product	DC [mm]	DCON MS [mm]	APMX [mm]	OAL [mm]	NOF	LU [mm]	DN [mm]
C40310.0	10.00	10.00	45.00	95.0	4	–	–
C40312.0	12.00	12.00	53.00	110.0	4	–	–
C40314.0	14.00	12.00	53.00	110.0	4	64.50	11.50
C40316.0	16.00	16.00	63.00	123.0	4	74.50	15.50
C40318.0	18.00	16.00	63.00	123.0	4	74.50	15.50
C40320.0	20.00	20.00	75.00	141.0	4	90.50	19.50
C40330.0	30.00	25.00	90.00	166.0	5	109.50	24.50
C40332.0	32.00	32.00	106.00	186.0	6	125.50	31.00
C40336.0	36.00	32.00	106.00	186.0	6	125.50	31.50
C40340.0	40.00	40.00	125.00	217.0	6	146.50	39.00
C40345.0	45.00	40.00	125.00	217.0	6	146.50	39.50
C40350.0	50.00	50.00	150.00	252.0	6	171.50	48.00



C500



2-Flute HSS-E Ball-Nosed End Mill, Bright Finish

Extra short cut length, 2-flute design provides high rigidity for increased strength and reduced vibrations. Geometry designed for contouring complex surfaces on CNC m/c, suited for mild steels, mild non-ferrous materials and medium strength titanium alloys. Neck recess on cutting diameter equal to 14 mm and above.

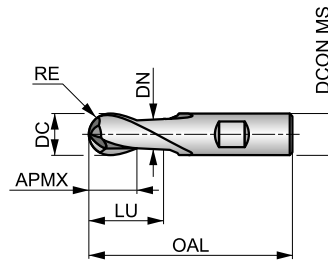

HSS-E	N	NOF 2
	λ 30°	γ 12°
DIN 1835B	Bright	DC e8
	DIN 327D	

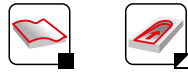

Workpiece material group suitability, starting values for cutting speed (m/min) and Alpha Code. Tables with feed per tooth and correction factors can be found starting from page 194.

P1.1 ■ 53 E	P1.2 ■ 59 E	P1.3 ■ 61 E	P2.1 ■ 45 E	P2.2 ■ 40 E	P3.1 ■ 36 E	P3.2 ■ 29 D	P4.1 ■ 22 D	M1.1 ■ 34 E	M1.2 ■ 29 E	M2.1 ■ 31 E	M2.2 ■ 25 D	K1.1 ■ 30 E	K1.2 ■ 22 E
K1.3 ■ 17 E	K2.1 ■ 55 E	K2.2 ■ 45 E	K2.3 ■ 36 D	K3.1 ■ 49 E	K3.2 ■ 37 E	K3.3 ■ 30 D	K4.1 ■ 45 D	K4.2 ■ 34 D	K4.3 ■ 25 D	K4.4 ■ 22 C	K4.5 ■ 18 C	K5.1 ■ 51 D	K5.2 ■ 39 D
K5.3 ■ 30 D	N1.1 ■ 95 G	N1.2 ■ 71 F	N1.3 ■ 48 F	N2.1 ■ 48 E	N2.2 ■ 43 E	N2.3 ■ 31 E	N3.1 ■ 50 E	N3.2 ■ 29 E	N3.3 ■ 15 E	N4.1 ■ 50 E	S1.1 ■ 30 D	S1.2 ■ 25 D	S2.1 ■ 20 C
S3.1 ■ 15 C	S4.1 ■ 12 C												

DCON MS tolerance h6; RE ±0.05 mm.

Product	DC [mm]	RE [mm]	DCON MS [mm]	APMX [mm]	OAL [mm]	NOF	LU [mm]	DN [mm]
C5002.0	2.00	1.00	6.00	4.00	48.0	2	–	–
C5003.0	3.00	1.50	6.00	5.00	49.0	2	–	–
C5004.0	4.00	2.00	6.00	7.00	51.0	2	–	–
C5005.0	5.00	2.50	6.00	8.00	52.0	2	–	–
C5006.0	6.00	3.00	6.00	8.00	52.0	2	–	–
C5007.0	7.00	3.50	10.00	10.00	60.0	2	–	–
C5008.0	8.00	4.00	10.00	11.00	61.0	2	–	–
C5009.0	9.00	4.50	10.00	11.00	61.0	2	–	–
C50010.0	10.00	5.00	10.00	13.00	63.0	2	–	–
C50012.0	12.00	6.00	12.00	16.00	73.0	2	–	–
C50014.0	14.00	7.00	12.00	16.00	73.0	2	27.50	11.50
C50015.0	15.00	7.50	12.00	16.00	73.0	2	27.50	11.50
C50016.0	16.00	8.00	16.00	19.00	79.0	2	30.50	15.50
C50018.0	18.00	9.00	16.00	19.00	79.0	2	30.50	15.50
C50020.0	20.00	10.00	20.00	22.00	88.0	2	37.50	19.50
C50025.0	25.00	12.50	25.00	26.00	102.0	2	45.50	24.50



C505



2-Flute HSS-E Ball-Nosed End Mill, Bright Finish

Short cut length, 2-flute design provides high rigidity for increased strength and reduced vibrations. Geometry designed for contouring complex surfaces on CNC machines, suited for mild steels, mild non-ferrous materials and medium strength titanium alloys. Neck recess on cutting diameter equal to 14 mm and above.

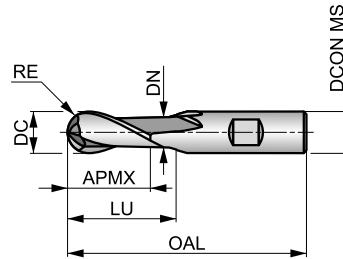

HSS-E	N	NOF 2
	λ 30°	γ 12°
DIN 1835B	Bright	DC e8
	DIN 844K	



Workpiece material group suitability, starting values for cutting speed (m/min) and Alpha Code. Tables with feed per tooth and correction factors can be found starting from page 194.

P1.1 ■ 46 D	P1.2 ■ 52 D	P1.3 ■ 54 D	P2.1 ■ 40 D	P2.2 ■ 35 D	P3.1 ■ 32 D	P3.2 ■ 26 C	P4.1 ■ 19 C	M1.1 ■ 34 D	M1.2 ■ 29 D	M2.1 ■ 31 D	M2.2 ■ 25 C	K1.1 ■ 30 D	K1.2 ■ 22 D
K1.3 ■ 17 D	K2.1 ■ 49 D	K2.2 ■ 40 D	K2.3 ■ 32 C	K3.1 ■ 44 D	K3.2 ■ 33 D	K3.3 ■ 27 B	K4.1 ■ 40 C	K4.2 ■ 30 C	K4.3 ■ 22 C	K4.4 ■ 19 B	K4.5 ■ 16 B	K5.1 ■ 46 C	K5.2 ■ 34 C
K5.3 ■ 27 C	N1.1 ■ 81 F	N1.2 ■ 60 E	N1.3 ■ 41 E	N2.1 ■ 41 D	N2.2 ■ 37 D	N2.3 ■ 26 D	N3.1 ■ 43 D	N3.2 ■ 25 D	N3.3 ■ 13 D	N4.1 ■ 43 D	S1.1 ■ 30 C	S1.2 ■ 25 C	S2.1 ■ 20 B
S3.1 ■ 15 B	S4.1 ■ 12 B												

DCON MS tolerance h6; RE ±0.05 mm.

Product	DC [mm]	RE [mm]	DCON MS [mm]	APMX [mm]	OAL [mm]	NOF	LU [mm]	DN [mm]
C5053.0	3.00	1.50	6.00	8.00	52.0	2	–	–
C5054.0	4.00	2.00	6.00	11.00	55.0	2	–	–
C5055.0	5.00	2.50	6.00	13.00	57.0	2	–	–
C5056.0	6.00	3.00	6.00	13.00	57.0	2	–	–
C5058.0	8.00	4.00	10.00	19.00	69.0	2	–	–
C50510.0	10.00	5.00	10.00	22.00	72.0	2	–	–
C50512.0	12.00	6.00	12.00	26.00	83.0	2	–	–
C50514.0	14.00	7.00	12.00	26.00	83.0	2	37.50	11.50
C50516.0	16.00	8.00	16.00	32.00	92.0	2	43.50	15.50
C50520.0	20.00	10.00	20.00	38.00	104.0	2	53.50	19.50
C50522.0	22.00	11.00	20.00	38.00	104.0	2	53.50	19.50
C50525.0	25.00	12.50	25.00	45.00	121.0	2	64.50	24.50
C50528.0	28.00	14.00	25.00	45.00	121.0	2	64.50	24.50
C50530.0	30.00	15.00	25.00	45.00	121.0	2	64.50	24.50



C800



HSS-E T-Slot Cutter

Suitable for milling T-slots. For accurate and stable holding in all types of toolholder, it has a combination shank and is capable of milling T-slots to accept standard T-bolts. The bright finish prevents workpiece material from sticking to the cutting edges of the tool.

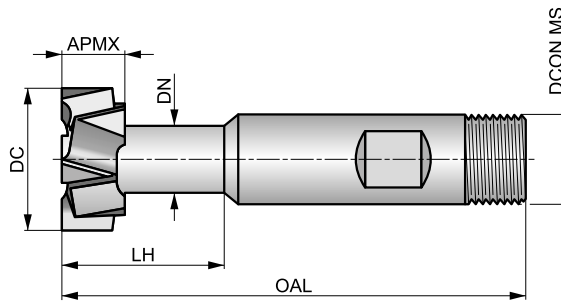

HSS-E	N	NOF 6-8
λ 15°	γ 10°	DIN 1835
Bright	DC d11	
DIN 851		



Workpiece material group suitability, starting values for cutting speed (m/min) and Alpha Code. Tables with feed per tooth and correction factors can be found starting from page 194.

P1.1 ■ 40 V	P1.2 ■ 45 V	P1.3 ■ 46 V	P2.1 ■ 34 V	P2.2 ■ 30 U	P2.3 ■ 27 T	P3.1 ■ 29 U	P3.2 ■ 24 U	P3.3 ■ 20 T	P4.1 ■ 18 U	P4.2 ■ 15 T	P4.3 ■ 12 T	M1.1 ■ 27 S	M1.2 ■ 23 S
M2.1 ■ 24 S	M2.2 ■ 20 S	M3.1 ■ 17 S	M3.2 ■ 15 S	M3.3 ■ 14 S	M4.1 ■ 10 S	K1.1 ■ 20 V	K1.2 ■ 15 V	K1.3 ■ 11 V	K2.1 ■ 37 U	K2.2 ■ 30 U	K2.3 ■ 24 U	K3.1 ■ 33 U	K3.2 ■ 25 U
K3.3 ■ 20 U	K4.1 ■ 30 S	K4.2 ■ 23 S	K4.3 ■ 17 S	K4.4 ■ 14 S	K4.5 ■ 12 S	K5.1 ■ 34 U	K5.2 ■ 26 U	K5.3 ■ 20 U	N1.1 ■ 71 Y	N1.2 ■ 53 Y	N1.3 ■ 36 Y	N2.1 ■ 36 Y	N2.2 ■ 32 Y
N2.3 ■ 23 Y	N3.1 ■ 38 V	N3.2 ■ 22 V	N3.3 ■ 11 W	N4.1 ■ 38 Y	S1.1 ■ 30 V	S1.2 ■ 20 V	S1.3 ■ 10 U	S2.1 ■ 13 U	S2.2 ■ 7 T	S3.1 ■ 10 U	S3.2 ■ 5 T	S4.1 ■ 8 U	S4.2 ■ 4 T

DCON MS tolerance h6.

Product	APMX	DC	T DIN650	DN	LH	OAL	DCON MS	NOF
	[mm]	[mm]		[mm]	[mm]	[mm]	[mm]	
C80011.0X5.0	4.00	11.00	5	4.00	10.5	53.5	10.00	6
C80012.5X6.0	6.00	12.50	6	5.00	15.0	57.0	10.00	6
C80016.0X8.0	8.00	16.00	8	7.00	20.0	62.0	10.00	6
C80018.0X10.0	8.00	18.00	10	8.00	23.0	70.0	12.00	6
C80021.0X12.0	9.00	21.00	12	10.00	27.0	74.0	12.00	8
C80025.0X14.0	11.00	25.00	14	12.00	31.0	82.0	16.00	8
C80032.0X18.0	14.00	32.00	18	15.00	40.0	90.0	16.00	8
C80040.0X22.0	18.00	40.00	22	19.00	45.0	108.0	25.00	8
C80050.0X28.0	22.00	50.00	28	25.00	56.0	124.0	32.00	8



C810



HSS T-Slot Cutter

Suitable for milling T-slots with a screw shank to ensure secure holding and capable of milling T-slots to accept standard T-bolts. The bright finish prevents workpiece material from sticking to the cutting edges of the tool.

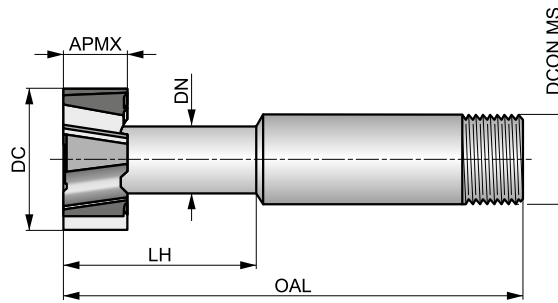

HSS	N	NOF 6-8
λ 12°	γ 10°	DIN 1835D
Bright	DC d11	
DORMER		

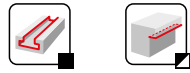

Workpiece material group suitability, starting values for cutting speed (m/min) and Alpha Code. Tables with feed per tooth and correction factors can be found starting from page 194.

P1.1 ■ 27V	P1.2 ■ 30V	P1.3 ■ 31V	P2.1 ■ 23V	P2.2 ■ 20U	P2.3 ▧ 18T	P3.1 ■ 15U	P3.2 ■ 12U	P3.3 ▧ 10T	P4.1 ■ 9U	P4.2 ▧ 7T	P4.3 ▧ 6T	M1.1 ■ 21S	M1.2 ■ 17S
M2.1 ■ 18S	M2.2 ■ 15S	M3.1 ▧ 12S	M3.2 ▧ 10S	M3.3 ▧ 9S	M4.1 ▧ 10S	K1.1 ■ 20V	K1.2 ■ 15V	K1.3 ■ 11V	K2.1 ■ 25U	K2.2 ■ 20U	K2.3 ■ 16U	K3.1 ■ 22U	K3.2 ■ 17U
K3.3 ■ 13U	K4.1 ■ 20S	K4.2 ■ 15S	K4.3 ■ 11S	K4.4 ■ 10S	K4.5 ■ 8S	K5.1 ■ 23U	K5.2 ■ 17U	K5.3 ■ 13U	N1.1 ■ 48Y	N1.2 ■ 36Y	N1.3 ■ 24Y	N2.1 ■ 24Y	N2.2 ■ 22Y
N2.3 ■ 16Y	N3.1 ■ 26V	N3.2 ■ 15V	N3.3 ■ 8W	N4.1 ▧ 26Y	S1.1 ■ 20V	S1.2 ▧ 15V	S1.3 ▧ 5U	S2.1 ▧ 7U	S2.2 ▧ 7T	S3.1 ▧ 5U	S3.2 ▧ 5T	S4.1 ▧ 4U	S4.2 ▧ 4T

DCON MS tolerance 0.-0.025 mm.

Product	APMX	APMX	DC	DC	T DIN650	DN	LH	OAL	DCONMS	DCON MS	NOF
	[inch]	[mm]	[inch]	[mm]		[mm]	[mm]	[mm]	[inch]	[mm]	
C8106.0	–	6.00	–	12.50	6.0	5.00	17.0	57.0	–	10.00	6
C8108.0	–	8.00	–	16.00	8.0	7.00	21.0	61.0	–	10.00	6
C81010.0	–	8.00	–	18.00	10.0	8.00	25.0	65.0	–	12.00	6
C81012.0	–	9.00	–	21.00	12.0	10.00	29.0	69.0	–	12.00	6
C81014.0	–	11.00	–	25.00	14.0	12.00	34.0	79.0	–	16.00	6
C81016.0	–	12.00	–	28.00	16.0	13.00	35.0	76.0	–	16.00	6
C81018.0	–	14.00	–	32.00	18.0	15.00	41.0	98.0	–	25.00	8
C81020.0	–	16.00	–	36.00	20.0	17.00	46.0	100.0	–	25.00	8
C81022.0	–	18.00	–	40.00	22.0	19.00	51.0	108.0	–	25.00	8



C825



HSS-E Side and Face Cutter

Versatile side and face cutters for grooving and slot milling. The Weldon shank provides accurate and stable holding whilst the side and face milling head makes the tools good for creating slots in vertical walls. The bright finish prevents workpiece material from sticking to the cutting edges of the tool.

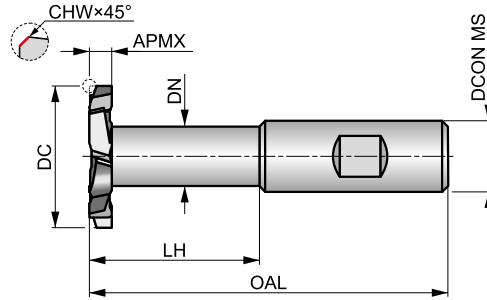

HSS-E	N	NOF 8-12
λ 15°	γ 15°	DIN 1835B
Bright	DC js16	
DORMER		

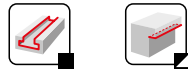

Workpiece material group suitability, starting values for cutting speed (m/min) and Alpha Code. Tables with feed per tooth and correction factors can be found starting from page 194.

P1.1 ■ 40 V	P1.2 ■ 45 V	P1.3 ■ 46 V	P2.1 ■ 34 V	P2.2 ■ 30 U	P2.3 ■ 27 T	P3.1 ■ 22 U	P3.2 ■ 18 U	P3.3 ■ 15 T	P4.1 ■ 13 U	P4.2 ■ 11 T	P4.3 ■ 9 T	M1.1 ■ 21 S	M1.2 ■ 17 S
M2.1 ■ 18 S	M2.2 ■ 15 S	M3.1 ■ 12 S	M3.2 ■ 10 S	M3.3 ■ 9 S	M4.1 ■ 10 S	K1.1 ■ 25 V	K1.2 ■ 19 V	K1.3 ■ 14 V	K2.1 ■ 37 U	K2.2 ■ 30 U	K2.3 ■ 24 U	K3.1 ■ 33 U	K3.2 ■ 25 U
K3.3 ■ 20 U	K4.1 ■ 30 S	K4.2 ■ 23 S	K4.3 ■ 17 S	K4.4 ■ 14 S	K4.5 ■ 12 S	K5.1 ■ 34 U	K5.2 ■ 26 U	K5.3 ■ 20 U	N1.1 ■ 71 Y	N1.2 ■ 53 Y	N1.3 ■ 36 Y	N2.1 ■ 36 Y	N2.2 ■ 32 Y
N2.3 ■ 23 Y	N3.1 ■ 38 V	N3.2 ■ 22 V	N3.3 ■ 11 W	N4.1 ■ 38 Y	S1.1 ■ 35 V	S1.2 ■ 20 V	S1.3 ■ 10 U	S2.1 ■ 7 U	S2.2 ■ 7 T	S3.1 ■ 5 U	S3.2 ■ 5 T	S4.1 ■ 4 U	S4.2 ■ 4 T

DCON MS tolerance h6.

Product	APMX	DC	CHW	DN	LH	OAL	DCON MS	NOF
	[mm]	[mm]	[mm]	[mm]	[mm]	[mm]	[mm]	
C8253.0X40.0	3.00	40.00	0.15	19.20	49.0	100.0	20.00	8
C8254.0X40.0	4.00	40.00	0.15	19.20	49.0	100.0	20.00	8
C8255.0X40.0	5.00	40.00	0.15	19.20	49.0	100.0	20.00	8
C8256.0X40.0	6.00	40.00	0.15	19.20	49.0	100.0	20.00	8
C8258.0X40.0	8.00	40.00	0.15	19.20	49.0	100.0	20.00	8
C82510.0X40.0	10.00	40.00	0.15	19.20	49.0	100.0	20.00	8
C8256.0X63.0	6.00	63.00	0.15	24.20	73.0	130.0	25.00	12
C8258.0X63.0	8.00	63.00	0.15	24.20	73.0	130.0	25.00	12
C82510.0X63.0	10.00	63.00	0.15	24.20	73.0	130.0	25.00	12
C82512.0X63.0	12.00	63.00	0.15	24.20	73.0	130.0	25.00	12
C82514.0X63.0	14.00	63.00	0.15	24.20	73.0	130.0	25.00	12
C82516.0X63.0	16.00	63.00	0.15	24.20	73.0	130.0	25.00	12



C801



HSS-E Roughing T-slot Cutter

Suitable for rough milling T-slots, to accept standard T-bolts with Weldon shank for accurate and stable holding. The NF profile breaks chips for an efficient roughing application. The bright finish prevents workpiece material from sticking to the cutting edges of the tool.

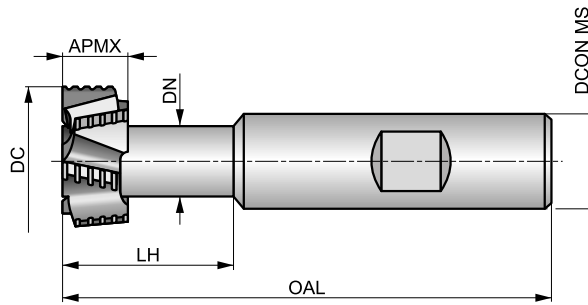

HSS-E	NF	NOF 6-8
λ 12°	γ 10°	DIN 1835B
Bright	DC d11	
DIN 851		

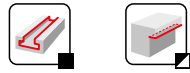

Workpiece material group suitability, starting values for cutting speed (m/min) and Alpha Code. Tables with feed per tooth and correction factors can be found starting from page 194.

P1.1 ■ 40V	P1.2 ■ 45V	P1.3 ■ 46V	P2.1 ■ 34V	P2.2 ■ 30U	P2.3 ■ 27T	P3.1 ■ 29U	P3.2 ■ 24U	P3.3 ■ 20T	P4.1 ■ 18U	P4.2 ■ 15T	P4.3 ■ 12T	M1.1 ■ 34S	M1.2 ■ 29S
M2.1 ■ 31S	M2.2 ■ 25S	M3.1 ■ 17S	M3.2 ■ 15S	M3.3 ■ 14S	M4.1 ■ 15S	K1.1 ■ 25V	K1.2 ■ 19V	K1.3 ■ 14V	K2.1 ■ 43U	K2.2 ■ 35U	K2.3 ■ 28U	K3.1 ■ 38U	K3.2 ■ 29U
K3.3 ■ 24U	K4.1 ■ 35S	K4.2 ■ 27S	K4.3 ■ 20S	K4.4 ■ 17S	K4.5 ■ 14S	K5.1 ■ 40U	K5.2 ■ 30U	K5.3 ■ 23U	N1.1 ■ 71Y	N1.2 ■ 53Y	N1.3 ■ 36Y	N2.1 ■ 36Y	N2.2 ■ 32Y
N2.3 ■ 23Y	N3.1 ■ 38V	N3.2 ■ 22V	N3.3 ■ 11W	N4.1 ■ 38Y	S1.1 ■ 30V	S1.2 ■ 20V	S1.3 ■ 10U	S2.1 ■ 13U	S2.2 ■ 7T	S3.1 ■ 10U	S3.2 ■ 5T	S4.1 ■ 8U	S4.2 ■ 4T

DCON MS tolerance h6.

Product	APMX	DC	T DIN650	DN	LH	OAL	DCON MS	NOF
	[mm]	[mm]		[mm]	[mm]	[mm]	[mm]	
C80116.0X8.0	8.00	16.00	8	7.00	18.0	62.0	10.00	6
C80118.0X10.0	8.00	18.00	10	8.00	21.0	70.0	12.00	6
C80121.0X12.0	9.00	21.00	12	10.00	25.0	74.0	12.00	6
C80125.0X14.0	11.00	25.00	14	12.00	28.0	82.0	16.00	8
C80132.0X18.0	14.00	32.00	18	15.00	36.0	90.0	16.00	8



C837



HSS Dovetail Cutter

Designed with a 45° angle to mill common dovetail slots. It has a screwed shank to make sure the tool can be held securely. Suitable for milling dovetail forms. The bright finish prevents workpiece material from sticking to the cutting edges of the tool.

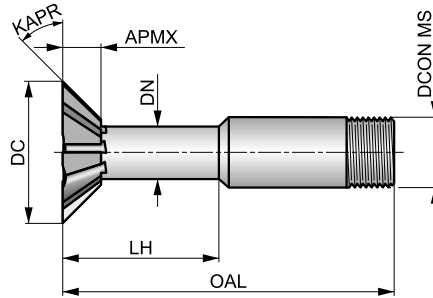

HSS	N	NOF 6-8
λ 0°	γ 0°	DIN 1835D
Bright		DORMER



Workpiece material group suitability, starting values for cutting speed (m/min) and Alpha Code. Tables with feed per tooth and correction factors can be found starting from page 194.

P1.1 ■ 20Y	P1.2 ■ 22Y	P1.3 ■ 23Y	P2.1 ■ 17Y	P2.2 ■ 15X	P2.3 ■ 13X	P3.1 ■ 15X	P3.2 ■ 12X	P3.3 ■ 10X	P4.1 ■ 9X	P4.2 ■ 17X	P4.3 ■ 6X	M1.1 ■ 14W	M1.2 ■ 12W
M2.1 ■ 12W	M2.2 ■ 10W	M3.1 ■ 12W	M3.2 ■ 10W	M3.3 ■ 9W	M4.1 ■ 5W	K1.1 ■ 15Y	K1.2 ■ 11Y	K1.3 ■ 8Y	K2.1 ■ 18X	K2.2 ■ 15X	K2.3 ■ 12X	K3.1 ■ 16X	K3.2 ■ 12X
K3.3 ■ 10X	K4.1 ■ 15W	K4.2 ■ 11W	K4.3 ■ 8W	K4.4 ■ 7W	K4.5 ■ 6W	K5.1 ■ 17X	K5.2 ■ 13X	K5.3 ■ 10X	N1.1 ■ 36Z	N1.2 ■ 27Z	N1.3 ■ 18Z	N2.1 ■ 18Z	N2.2 ■ 16Z
N2.3 ■ 12Z	N3.1 ■ 19Y	N3.2 ■ 11Y	N3.3 ■ 6Z	N4.1 ■ 19Z	S1.1 ■ 15Y	S1.2 ■ 10Y	S1.3 ■ 5X	S2.1 ■ 7W	S2.2 ■ 7W	S3.1 ■ 5W	S3.2 ■ 5W	S4.1 ■ 4W	S4.2 ■ 4W

DCON MS tolerance 0-0.025 mm.

Product	KAPR	APMX	DC	DC	DN	LH	OAL	DCONMS	DCON MS	NOF
	[°]	[mm]	[inch]	[mm]	[mm]	[mm]	[mm]	[inch]	[mm]	
C83713.0	45	3.00	—	13.00	4.75	19.5	63.5	—	12.00	6
C8375/8¹⁾	45	4.00	5/8	15.88	6.35	21.5	66.5	1/2	12.70	6
C83716.0	45	4.00	—	16.00	6.35	21.5	66.5	—	12.00	6
C83719.0	45	5.50	—	19.00	6.35	21.5	66.5	—	12.00	6
C8373/4¹⁾	45	5.50	3/4	19.05	6.35	21.5	66.5	1/2	12.70	6
C83722.0	45	6.50	—	22.00	7.15	22.5	68.5	—	12.00	6
C8377/8¹⁾	45	6.50	7/8	22.23	7.15	22.5	68.5	1/2	12.70	6
C83725.0	45	7.50	—	25.00	7.95	24.0	70.0	—	12.00	6
C8371¹⁾	45	8.00	1"	25.40	7.95	24.0	70.0	1/2	12.70	6
C83728.0	45	8.50	—	28.00	9.55	25.5	71.5	—	16.00	6
C83738.0	45	10.50	—	38.00	12.70	26.5	78.5	—	25.00	8

¹⁾ Standard - BS 122/4.



C835



HSS Dovetail Cutter

Designed with a 60° angle, it is suitable for milling common dovetail forms. The screwed shank provides secure holding. The bright finish prevents workpiece material from sticking to the cutting edges of the tool.

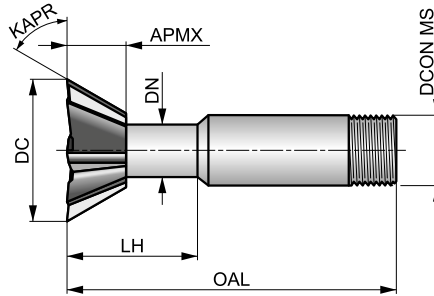

HSS	N	NOF 6-8
λ 0°	γ 0°	DIN 1835D
Bright		DORMER



Workpiece material group suitability, starting values for cutting speed (m/min) and Alpha Code. Tables with feed per tooth and correction factors can be found starting from page 194.

P1.1 ■ 20Y	P1.2 ■ 22Y	P1.3 ■ 23Y	P2.1 ■ 17Y	P2.2 ■ 15X	P2.3 ■ 13X	P3.1 ■ 15X	P3.2 ■ 12X	P3.3 ■ 10X	P4.1 ■ 9X	P4.2 ■ 7X	P4.3 ■ 6X	M1.1 ■ 14W	M1.2 ■ 12W
M2.1 ■ 12W	M2.2 ■ 10W	M3.1 ■ 12W	M3.2 ■ 10W	M3.3 ■ 9W	M4.1 ■ 5W	K1.1 ■ 15Y	K1.2 ■ 11Y	K1.3 ■ 8Y	K2.1 ■ 18X	K2.2 ■ 15X	K2.3 ■ 12X	K3.1 ■ 16X	K3.2 ■ 12X
K3.3 ■ 10X	K4.1 ■ 15W	K4.2 ■ 11W	K4.3 ■ 8W	K4.4 ■ 7W	K4.5 ■ 6W	K5.1 ■ 17X	K5.2 ■ 13X	K5.3 ■ 10X	N1.1 ■ 36Z	N1.2 ■ 27Z	N1.3 ■ 18Z	N2.1 ■ 18Z	N2.2 ■ 16Z
N2.3 ■ 12Z	N3.1 ■ 19Y	N3.2 ■ 11Y	N3.3 ■ 6Z	N4.1 ■ 19Z	S1.1 ■ 15Y	S1.2 ■ 10Y	S1.3 ■ 5X	S2.1 ■ 7W	S2.2 ■ 7W	S3.1 ■ 5W	S3.2 ■ 5W	S4.1 ■ 4W	S4.2 ■ 4W

DCON MS tolerance 0.0-0.025 mm.

Product	KAPR	APMX	DC	DC	DN	LH	OAL	DCONMS	DCON MS	NOF
	[°]	[mm]	[inch]	[mm]	[mm]	[mm]	[mm]	[inch]	[mm]	
C8351/2 ¹⁾	60	4.00	1/2	12.70	7.15	20.5	63.5	1/2	12.70	6
C83513.0	60	4.00	–	13.00	7.15	20.5	63.5	–	12.00	6
C8355/8 ¹⁾	60	5.50	5/8	15.88	7.55	23.5	66.5	1/2	12.70	6
C83516.0	60	5.50	–	16.00	7.55	23.5	66.5	–	12.00	6
C83519.0	60	7.00	–	19.00	8.35	24.5	67.5	–	12.00	6
C8353/4 ¹⁾	60	7.00	3/4	19.05	8.35	24.5	67.5	1/2	12.70	6
C83522.0	60	9.50	–	22.00	8.75	24.5	67.5	–	12.00	6
C8357/8 ¹⁾	60	9.50	7/8	22.23	8.75	24.5	67.5	1/2	12.70	6
C83525.0	60	12.00	–	25.00	8.75	27.0	70.0	–	12.00	6
C8351 ¹⁾	60	12.00	1"	25.40	8.75	27.0	70.0	1/2	12.70	6
C83528.0	60	12.50	–	28.00	11.10	28.0	73.0	–	16.00	6
C8351.1/8 ¹⁾	60	12.50	1.1/8	28.58	11.10	28.0	73.0	5/8	15.88	6
C83532.0	60	13.50	–	32.00	12.70	29.5	74.5	–	16.00	8
C8351.1/4 ¹⁾	60	13.50	1.1/4	31.75	12.70	29.5	74.5	5/8	15.88	8
C8351.3/8 ¹⁾	60	14.50	1.3/8	34.93	12.70	30.5	82.5	1"	25.40	8
C83535.0	60	14.50	–	35.00	12.70	30.5	82.5	–	25.00	8
C83538.0	60	16.00	–	38.00	17.45	32.0	84.0	–	25.00	8
C8351.1/2 ¹⁾	60	16.00	1.1/2	38.10	17.45	32.0	84.0	1"	25.40	8

¹⁾ Standard - BS 122/4.



C830



HSS-E Dovetail Cutter

Designed with the optional 45° and 60° angle and Weldon shank for accurate and stable holding, it is suitable for common dovetail forms. The bright finish prevents workpiece material from sticking to the cutting edges of the tool.

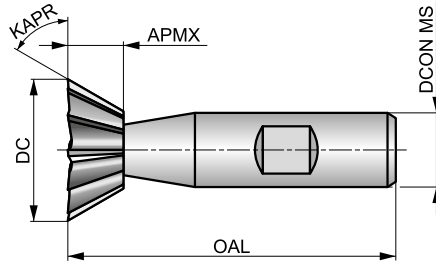

HSS-E	N	NOF 10-12
λ 0°	γ 0°	DIN 1835B
Bright	DC js16	
DIN 1833C		



Workpiece material group suitability, starting values for cutting speed (m/min) and Alpha Code. Tables with feed per tooth and correction factors can be found starting from page 194.

P1.1 ■ 33 Y	P1.2 ■ 37 Y	P1.3 ■ 38 Y	P2.1 ■ 28 Y	P2.2 ■ 25 X	P2.3 ■ 22 X	P3.1 ■ 22 X	P3.2 ■ 18 X	P3.3 ■ 15 X	P4.1 ■ 13 X	P4.2 ■ 11 X	P4.3 ■ 9 X	M1.1 ■ 27 W	M1.2 ■ 23 W
M2.1 ■ 24 W	M2.2 ■ 20 W	M3.1 ■ 17 W	M3.2 ■ 15 W	M3.3 ■ 14 W	M4.1 ■ 10 W	K1.1 ■ 20 Y	K1.2 ■ 15 Y	K1.3 ■ 11 Y	K2.1 ■ 31 X	K2.2 ■ 25 X	K2.3 ■ 20 X	K3.1 ■ 27 X	K3.2 ■ 21 X
K3.3 ■ 17 X	K4.1 ■ 25 W	K4.2 ■ 19 W	K4.3 ■ 14 W	K4.4 ■ 12 W	K4.5 ■ 10 W	K5.1 ■ 29 X	K5.2 ■ 21 X	K5.3 ■ 17 X	N1.1 ■ 59 Z	N1.2 ■ 44 Z	N1.3 ■ 30 Z	N2.1 ■ 30 Z	N2.2 ■ 27 Z
N2.3 ■ 19 Z	N3.1 ■ 31 Y	N3.2 ■ 18 Y	N3.3 ■ 9 Z	N4.1 ■ 31 Z	S1.1 ■ 25 Y	S1.2 ■ 15 Y	S1.3 ■ 10 X	S2.1 ■ 13 W	S2.2 ■ 7 W	S3.1 ■ 10 W	S3.2 ■ 5 W	S4.1 ■ 8 W	S4.2 ■ 4 W

DCON MS tolerance h6.

Product	KAPR	APMX	DC	OAL	DCON MS	NOF
	[°]	[mm]	[mm]	[mm]	[mm]	
C83012.0X45	45	3.50	12.00	54.0	10.00	10
C83016.0X45	45	4.00	16.00	60.0	12.00	10
C83020.0X45	45	5.00	20.00	63.0	12.00	10
C83025.0X45	45	6.30	25.00	67.0	12.00	10
C83032.0X45	45	8.00	32.00	71.0	16.00	12
C83012.0X60	60	5.00	12.00	54.0	10.00	10
C83016.0X60	60	6.30	16.00	60.0	12.00	10
C83020.0X60	60	8.00	20.00	63.0	12.00	10
C83025.0X60	60	10.00	25.00	67.0	12.00	10
C83032.0X60	60	12.50	32.00	71.0	16.00	12



C831



HSS-E Inverted Dovetail Cutter

Suitable for milling common inverted dovetail slots with optional 45° and 60° angles and Weldon shank for accurate and stable holding. The bright finish prevents workpiece material from sticking to the cutting edges of the tool.

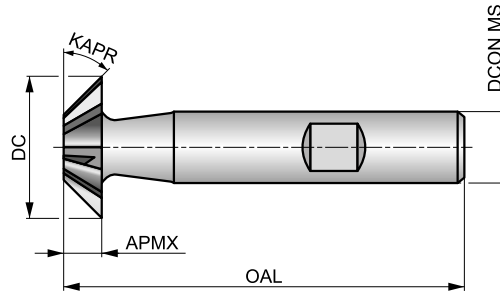

HSS-E	N	NOF 10-12
λ 0°	γ 0°	DIN 1835B
Bright	DC js16	
DIN 1833D		



Workpiece material group suitability, starting values for cutting speed (m/min) and Alpha Code. Tables with feed per tooth and correction factors can be found starting from page 194.

P1.1 ■ 33 Y	P1.2 ■ 37 Y	P1.3 ■ 38 Y	P2.1 ■ 28 Y	P2.2 ■ 25 X	P2.3 ■ 22 X	P3.1 ■ 22 X	P3.2 ■ 18 X	P3.3 ■ 15 X	P4.1 ■ 13 X	P4.2 ■ 11 X	P4.3 ■ 9 X	M1.1 ■ 27 W	M1.2 ■ 23 W
M2.1 ■ 24 W	M2.2 ■ 20 W	M3.1 ■ 17 W	M3.2 ■ 15 W	M3.3 ■ 14 W	M4.1 ■ 10 W	K1.1 ■ 20 Y	K1.2 ■ 15 Y	K1.3 ■ 11 Y	K2.1 ■ 31 X	K2.2 ■ 25 X	K2.3 ■ 20 X	K3.1 ■ 27 X	K3.2 ■ 21 X
K3.3 ■ 17 X	K4.1 ■ 25 W	K4.2 ■ 19 W	K4.3 ■ 14 W	K4.4 ■ 12 W	K4.5 ■ 10 W	K5.1 ■ 29 X	K5.2 ■ 21 X	K5.3 ■ 17 X	N1.1 ■ 59 Z	N1.2 ■ 44 Z	N1.3 ■ 30 Z	N2.1 ■ 30 Z	N2.2 ■ 27 Z
N2.3 ■ 19 Z	N3.1 ■ 31 Y	N3.2 ■ 18 Y	N3.3 ■ 9 Z	N4.1 ■ 31 Z	S1.1 ■ 25 Y	S1.2 ■ 15 Y	S1.3 ■ 10 X	S2.1 ■ 13 W	S2.2 ■ 7 W	S3.1 ■ 10 W	S3.2 ■ 5 W	S4.1 ■ 8 W	S4.2 ■ 4 W

DCON MS tolerance h6.

Product	KAPR	APMX	DC	OAL	DCON MS	NOF
	[°]	[mm]	[mm]	[mm]	[mm]	
C83112.0X45	45	3.50	12.00	54.0	10.00	10
C83116.0X45	45	4.00	16.00	60.0	12.00	10
C83120.0X45	45	5.00	20.00	63.0	12.00	10
C83125.0X45	45	6.30	25.00	67.0	12.00	10
C83132.0X45	45	8.00	32.00	71.0	16.00	12
C83112.0X60	60	5.00	12.00	54.0	10.00	10
C83116.0X60	60	6.30	16.00	60.0	12.00	10
C83120.0X60	60	8.00	20.00	63.0	12.00	10
C83125.0X60	60	10.00	25.00	67.0	12.00	10
C83132.0X60	60	12.50	32.00	71.0	16.00	12



C710



HSS Corner Rounding Cutter

With an accurate ground radius, capable of profile milling imperial corner radii around the perimeter of a component. The screwed shank makes sure the tool is held securely and improves the radius surface finish. It can be used for corner radius milling. Bright finish.

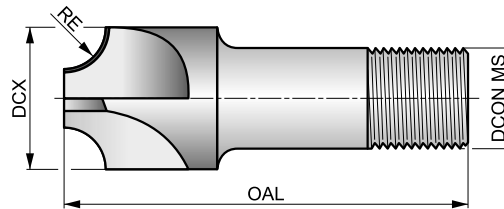

HSS	N	NOF 4
	λ 0°	γ 0°
DIN 1835D	Bright	
BS 122/4		



Workpiece material group suitability, starting values for cutting speed (m/min) and Alpha Code. Tables with feed per tooth and correction factors can be found starting from page 194.

P1.1 ■ 20 W	P1.2 ■ 22 W	P1.3 ■ 23 W	P2.1 ■ 17 W	P2.2 ■ 15 W	P2.3 ▧ 13 W	P3.1 ■ 15 W	P3.2 ■ 12 W	P3.3 ▧ 10 W	P4.1 ■ 9 W	P4.2 ▧ 7 W	P4.3 ▧ 6 W	M1.1 ■ 21 U	M1.2 ■ 17 U
M2.1 ■ 18 U	M2.2 ■ 15 U	M3.1 ■ 12 U	M3.2 ■ 10 U	M3.3 ▧ 9 U	M4.1 ▧ 5 U	K1.1 ■ 20 W	K1.2 ■ 15 W	K1.3 ■ 11 W	K2.1 ■ 18 W	K2.2 ■ 15 W	K2.3 ■ 12 W	K3.1 ■ 16 W	K3.2 ■ 12 W
K3.3 ■ 10 W	K4.1 ■ 15 U	K4.2 ■ 11 U	K4.3 ■ 8 U	K4.4 ■ 7 U	K4.5 ■ 6 U	K5.1 ■ 17 W	K5.2 ■ 13 W	K5.3 ■ 10 W	N1.1 ■ 36 X	N1.2 ■ 27 X	N1.3 ■ 18 X	N2.1 ■ 18 X	N2.2 ■ 16 X
N2.3 ■ 12 X	N3.1 ■ 19 X	N3.2 ■ 11 X	N3.3 ■ 6 X	S1.1 ■ 15 U	S1.2 ■ 10 U	S1.3 ▧ 5 U	S2.1 ■ 7 U	S2.2 ▧ 7 U	S3.1 ■ 5 U	S3.2 ▧ 5 U	S4.1 ■ 4 U	S4.2 ▧ 4 U	

DCON MS tolerance h8.

Product	RE	DCX	DCONMS	DCON MS	OAL	NOF
	[inch]	[inch]	[inch]	[mm]	[mm]	
C7101/16	1/16	3/8	3/8	9.53	60.5	4
C7101/8	1/8	1/2	1/2	12.70	60.5	4
C7105/32	5/32	9/16	1/2	12.70	60.5	4
C7103/16	3/16	5/8	5/8	15.88	60.5	4
C7101/4	1/4	7/8	5/8	15.88	63.5	4
C7103/8	3/8	1.1/16	1"	25.40	76.0	4
C7101/2	1/2	1.3/8	1"	25.40	82.5	4



C700



HSS-E Corner Rounding Cutter

With an accurate ground radius, suitable for producing accurate corner radii around the perimeter of components. The Weldon shank ensures stable holding to improve radius surface finish. Suitable for corner radius milling. Bright finish.

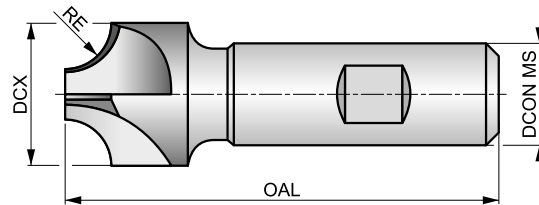

HSS-E	N	NOF 4-6
	λ 0°	γ 0°
DIN 1835B	Bright	
DORMER		



Workpiece material group suitability, starting values for cutting speed (m/min) and Alpha Code. Tables with feed per tooth and correction factors can be found starting from page 194.

P1.1 ■ 33 W	P1.2 ■ 37 W	P1.3 ■ 38 W	P2.1 ■ 28 W	P2.2 ■ 25 W	P2.3 ■ 22 W	P3.1 ■ 22 W	P3.2 ■ 18 W	P3.3 ■ 15 W	P4.1 ■ 13 W	P4.2 ■ 11 W	P4.3 ■ 9 W	M1.1 ■ 27 U	M1.2 ■ 23 U
M2.1 ■ 24 U	M2.2 ■ 20 U	M3.1 ■ 17 U	M3.2 ■ 15 U	M3.3 ■ 14 U	M4.1 ■ 10 U	K1.1 ■ 20 W	K1.2 ■ 15 W	K1.3 ■ 11 W	K2.1 ■ 31 W	K2.2 ■ 25 W	K2.3 ■ 20 W	K3.1 ■ 27 W	K3.2 ■ 21 W
K3.3 ■ 17 W	K4.1 ■ 25 U	K4.2 ■ 19 U	K4.3 ■ 14 U	K4.4 ■ 12 U	K4.5 ■ 10 U	K5.1 ■ 29 W	K5.2 ■ 21 W	K5.3 ■ 17 W	N1.1 ■ 57 X	N1.2 ■ 43 X	N1.3 ■ 29 X	N2.1 ■ 29 X	N2.2 ■ 26 X
N2.3 ■ 19 X	N3.1 ■ 30 X	N3.2 ■ 17 X	N3.3 ■ 9 X	S1.1 ■ 25 U	S1.2 ■ 20 U	S1.3 ■ 10 U	S2.1 ■ 13 U	S2.2 ■ 7 U	S3.1 ■ 10 U	S3.2 ■ 5 U	S4.1 ■ 8 U	S4.2 ■ 4 U	

DCON MS tolerance h6.

Product	RE [mm]	DCX [mm]	DCON MS [mm]	OAL [mm]	NOF
C7001.0	1.00	10.00	10.00	60.0	4
C7001.5	1.50	10.00	10.00	60.0	4
C7002.0	2.00	10.00	10.00	60.0	4
C7002.5	2.50	10.00	10.00	60.0	4
C7003.0	3.00	12.00	12.00	60.0	4
C7003.5	3.50	12.00	12.00	60.0	4
C7004.0	4.00	15.00	12.00	60.0	4
C7005.0	5.00	18.00	16.00	70.0	4
C7006.0	6.00	21.00	16.00	70.0	4
C7007.0	7.00	24.00	16.00	70.0	4
C7008.0	8.00	24.00	16.00	70.0	4
C7009.0	9.00	28.00	20.00	85.0	4
C70010.0	10.00	28.00	20.00	85.0	4
C70012.0	12.00	35.00	20.00	100.0	4
C70012.5	12.50	35.00	20.00	100.0	4
C70014.0	14.00	42.00	25.00	100.0	4
C70015.0	15.00	48.00	25.00	105.0	5
C70016.0	16.00	48.00	25.00	105.0	5
C70020.0	20.00	60.00	32.00	115.0	6



C822



HSS-E Woodruff Cutter

Suitable for milling Woodruff keys in spindles and shafts. The combination shank provides stable and accurate holding in all types of holders. The bright finish prevents workpiece material from sticking to the cutting edges of the tool.

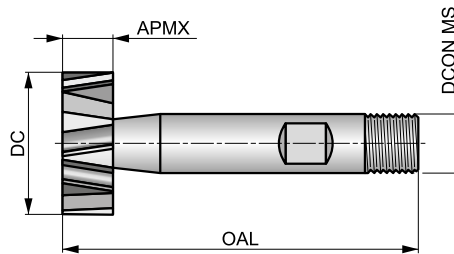

HSS-E	N	NOF 6-12
λ 10°	γ 10°	DIN 1835
Bright	DC h11	
DIN 850		

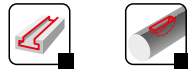

Workpiece material group suitability, starting values for cutting speed (m/min) and Alpha Code. Tables with feed per tooth and correction factors can be found starting from page 194.

P1.1 ■ 40 V	P1.2 ■ 45 V	P1.3 ■ 46 V	P2.1 ■ 34 V	P2.2 ■ 30 U	P2.3 ■ 27 T	P3.1 ■ 29 U	P3.2 ■ 24 U	P3.3 ■ 20 T	P4.1 ■ 18 U	P4.2 ■ 15 T	P4.3 ■ 12 T	M1.1 ■ 34 S	M1.2 ■ 29 S
M2.1 ■ 31 S	M2.2 ■ 25 S	M3.1 ■ 17 S	M3.2 ■ 15 S	M3.3 ■ 14 S	M4.1 ■ 15 S	K1.1 ■ 25 V	K1.2 ■ 19 V	K1.3 ■ 14 V	K2.1 ■ 37 U	K2.2 ■ 30 U	K2.3 ■ 24 U	K3.1 ■ 33 U	K3.2 ■ 25 U
K3.3 ■ 20 U	K4.1 ■ 30 S	K4.2 ■ 23 S	K4.3 ■ 17 S	K4.4 ■ 14 S	K4.5 ■ 12 S	K5.1 ■ 34 U	K5.2 ■ 26 U	K5.3 ■ 20 U	N1.1 ■ 71 Y	N1.2 ■ 53 Y	N1.3 ■ 36 Y	N2.1 ■ 36 Y	N2.2 ■ 32 Y
N2.3 ■ 23 Y	N3.1 ■ 38 V	N3.2 ■ 22 V	N3.3 ■ 11 W	N4.1 ■ 38 Y	S1.1 ■ 30 V	S1.2 ■ 20 V	S1.3 ■ 10 U	S2.1 ■ 13 U	S2.2 ■ 7 T	S3.1 ■ 10 U	S3.2 ■ 5 T	S4.1 ■ 8 U	S4.2 ■ 4 T

DCON MS tolerance h6.

Product	APMX [mm]	DC [mm]	OAL [mm]	DCON MS [mm]	NOF
C8224.5X1.0	1.00	4.50	50.0	6.00	6
C8227.5X1.5	1.50	7.50	50.0	6.00	6
C8227.5X2.0	2.00	7.50	50.0	6.00	6
C82210.5X2.0	2.00	10.50	50.0	6.00	8
C82210.5X2.5	2.50	10.50	50.0	6.00	8
C82210.5X3.0	3.00	10.50	50.0	6.00	8
C82213.5X3.0	3.00	13.50	56.0	10.00	8
C82213.5X4.0	4.00	13.50	56.0	10.00	8
C82216.5X3.0	3.00	16.50	56.0	10.00	8
C82216.5X4.0	4.00	16.50	56.0	10.00	8
C82216.5X5.0	5.00	16.50	56.0	10.00	8
C82219.5X3.0	3.00	19.50	63.0	10.00	10
C82219.5X4.0	4.00	19.50	63.0	10.00	10
C82219.5X5.0	5.00	19.50	63.0	10.00	10
C82222.5X5.0	5.00	22.50	63.0	10.00	10
C82222.5X6.0	6.00	22.50	63.0	10.00	10
C82222.5X8.0	8.00	22.50	63.0	10.00	10
C82225.5X6.0	6.00	25.50	63.0	10.00	12
C82228.5X6.0	6.00	28.50	63.0	10.00	12
C82228.5X8.0	8.00	28.50	63.0	10.00	12
C82228.5X10.0	10.00	28.50	71.0	12.00	12
C82232.5X8.0	8.00	32.50	71.0	12.00	12
C82232.5X10.0	10.00	32.50	71.0	12.00	12
C82245.5X10.0	10.00	45.50	71.0	12.00	12



C820



HSS Woodruff Cutter

Suitable for milling Woodruff keys in spindles and shafts. The screwed shank ensures secure holding. The bright finish prevents workpiece material from sticking to the cutting edges of the tool.

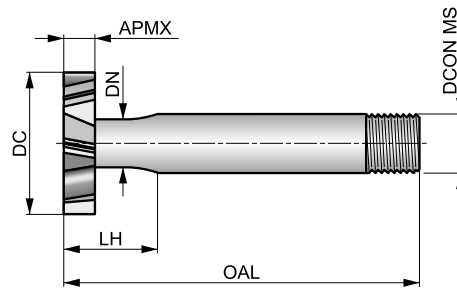

HSS	N	NOF 6-12
λ 12°	γ 10°	DIN 1835D
Bright		



Workpiece material group suitability, starting values for cutting speed (m/min) and Alpha Code. Tables with feed per tooth and correction factors can be found starting from page 194.

P1.1 ■ 27V	P1.2 ■ 30V	P1.3 ■ 31V	P2.1 ■ 23V	P2.2 ■ 20U	P2.3 ▣ 18T	P3.1 ■ 15U	P3.2 ■ 12U	P3.3 ▣ 10T	P4.1 ■ 9U	P4.2 ▣ 7T	P4.3 ▣ 6T	M1.1 ■ 21S	M1.2 ■ 17S
M2.1 ■ 18S	M2.2 ■ 15S	M3.1 ■ 12S	M3.2 ■ 10S	M3.3 ▣ 9S	M4.1 ▣ 10S	K1.1 ■ 20V	K1.2 ■ 15V	K1.3 ■ 11V	K2.1 ■ 25U	K2.2 ■ 20U	K2.3 ■ 16U	K3.1 ■ 22U	K3.2 ■ 17U
K3.3 ■ 13U	K4.1 ■ 20S	K4.2 ■ 15S	K4.3 ■ 11S	K4.4 ■ 10S	K4.5 ■ 8S	K5.1 ■ 23U	K5.2 ■ 17U	K5.3 ■ 13U	N1.1 ■ 48Y	N1.2 ■ 36Y	N1.3 ■ 24Y	N2.1 ■ 24Y	N2.2 ■ 22Y
N2.3 ■ 16Y	N3.1 ■ 26V	N3.2 ■ 15V	N3.3 ■ 8W	N4.1 ▣ 26Y	S1.1 ■ 20V	S1.2 ▣ 15V	S1.3 ▣ 10U	S2.1 ▣ 7U	S2.2 ▣ 7T	S3.1 ▣ 5U	S3.2 ▣ 5T	S4.1 ▣ 4U	S4.2 ▣ 4T

DCON MS tolerance 0.-0.025 mm.

Product	Nr.	APMX		DC		DN	LH	OAL	DCONMS	DCON MS	NOF
		[inch]	[mm]	[inch]	[mm]						
C82010.5X2.0	—	—	2.00	—	10.50	3.90	12.0	57.0	—	12.00	6
C82010.5X2.5	—	—	2.50	—	10.50	3.90	12.5	57.0	—	12.00	6
C82010.5X3.0	—	—	3.00	—	10.50	4.20	13.0	57.0	—	12.00	6
C820204 ¹⁾	204	1/16	1.59	1/2	12.70	3.30	11.6	57.0	1/2	12.70	6
C820404 ¹⁾	404	1/8	3.18	1/2	12.70	4.85	13.2	57.0	1/2	12.70	6
C82013.5X2.0	—	—	2.00	—	13.50	4.00	12.0	57.0	—	12.00	6
C82013.5X2.5	—	—	2.50	—	13.50	4.00	12.5	57.0	—	12.00	6
C82013.5X3.0	—	—	3.00	—	13.50	5.00	13.0	57.0	—	12.00	6
C82013.5X4.0	—	—	4.00	—	13.50	5.00	14.0	57.0	—	12.00	6
C820405 ¹⁾	405	1/8	3.18	5/8	15.88	5.65	13.2	57.0	1/2	12.70	6
C820505 ¹⁾	505	5/32	3.97	5/8	15.88	6.35	14.0	57.0	1/2	12.70	6
C82016.5X2.5	—	—	2.50	—	16.50	4.00	12.5	57.0	—	12.00	6
C82016.5X3.0	—	—	3.00	—	16.50	5.00	13.0	57.0	—	12.00	6
C82016.5X4.0	—	—	4.00	—	16.50	5.00	14.0	57.0	—	12.00	6
C82016.5X5.0	—	—	5.00	—	16.50	5.60	15.0	57.0	—	12.00	6
C820406 ¹⁾	406	1/8	3.18	3/4	19.05	5.50	13.2	57.0	1/2	12.70	6
C820506 ¹⁾	506	5/32	3.97	3/4	19.05	6.35	14.0	57.0	1/2	12.70	6
C820606 ¹⁾	606	3/16	4.76	3/4	19.05	7.15	14.8	57.0	1/2	12.70	6
C82019.5X3.0	—	—	3.00	—	19.50	5.60	13.0	57.0	—	12.00	6
C82019.5X4.0	—	—	4.00	—	19.50	5.60	14.0	57.0	—	12.00	6
C82019.5X5.0	—	—	5.00	—	19.50	6.00	15.0	57.0	—	12.00	6
C820507 ¹⁾	507	5/32	3.97	7/8	22.23	6.35	14.0	63.5	1/2	12.70	8
C820607 ¹⁾	607	3/16	4.76	7/8	22.23	7.15	14.8	63.5	1/2	12.70	8
C820807 ¹⁾	807	1/4	6.35	7/8	22.23	8.75	16.4	63.5	1/2	12.00	8
C82022.5X4.0	—	—	4.00	—	22.50	5.60	14.0	63.5	—	12.00	8



Product	Nr.	APMX	APMX	DC	DC	DN	LH	OAL	DCONMS	DCON MS	NOF
		[inch]	[mm]	[inch]	[mm]	[mm]	[mm]	[mm]	[inch]	[mm]	
C82022.5X5.0	–	–	5.00	–	22.50	6.00	15.0	63.5	–	12.00	8
C82022.5X6.0	–	–	6.00	–	22.50	6.50	16.0	63.5	–	12.00	8
C820608¹⁾	608	3/16	4.76	1"	25.40	7.15	14.8	70.0	1/2	12.70	8
C820808¹⁾	808	1/4	6.35	1"	25.40	8.75	16.4	70.0	1/2	12.70	8
C82025.5X5.0	–	–	5.00	–	25.50	7.50	15.0	70.0	–	12.00	8
C82025.5X6.0	–	–	6.00	–	25.50	7.50	16.0	70.0	–	12.00	8
C82025.5X8.0	–	–	8.00	–	25.50	8.00	18.0	70.0	–	12.00	8
C82028.5X5.0	–	–	5.00	–	28.50	8.00	17.0	70.0	–	12.00	8
C82028.5X6.0	–	–	6.00	–	28.50	8.50	18.0	70.0	–	12.00	8
C82028.5X8.0	–	–	8.00	–	28.50	9.00	20.0	70.0	–	12.00	8
C820610¹⁾	610	3/16	4.76	1.1/4	31.75	7.95	16.8	70.0	1/2	12.70	10
C820810¹⁾	810	1/4	6.35	1.1/4	31.75	9.50	18.4	70.0	1/2	12.70	10
C8201210¹⁾	1210	3/8	9.53	1.1/4	31.75	11.95	21.5	70.0	1/2	12.70	10
C82032.5X5.0¹⁾	–	–	5.00	–	32.50	8.00	17.0	70.0	–	12.00	10
C82032.5X6.0	–	–	6.00	–	32.50	8.50	18.0	70.0	–	12.00	10
C82032.5X8.0	–	–	8.00	–	32.50	9.00	20.0	70.0	–	12.00	10
C820811¹⁾	811	1/4	6.35	1.3/8	34.93	11.10	26.4	76.0	1/2	12.70	10
C8201211¹⁾	1211	3/8	9.53	1.3/8	34.93	11.95	29.5	76.0	1/2	12.70	10
C82035.5X6.0	–	–	6.00	–	35.50	9.50	26.0	76.0	–	12.00	10
C82035.5X8.0	–	–	8.00	–	35.50	11.50	28.0	76.0	–	12.00	10
C820812¹⁾	812	1/4	6.35	1.1/2	38.10	11.10	26.4	76.0	1/2	12.70	10
C8201212¹⁾	1212	3/8	9.53	1.1/2	38.10	11.95	29.5	76.0	1/2	12.70	10
C82038.5X8.0	–	–	8.00	–	38.50	11.50	28.0	76.0	–	12.00	10
C82038.5X10.0	–	–	10.00	–	38.50	11.50	30.0	76.0	–	12.00	10
C82045.5X10.0	–	–	10.00	–	45.50	11.50	30.0	76.0	–	12.00	12

¹⁾ Standard - BS 122/4.



D200



HSS-E Side and Face Coarse Pitch Milling Cutter

Versatile cutter designed to mill horizontal slots and is ideal for wide, deep slots. The bright finish prevents workpiece material from sticking to the cutting edges of the tool.

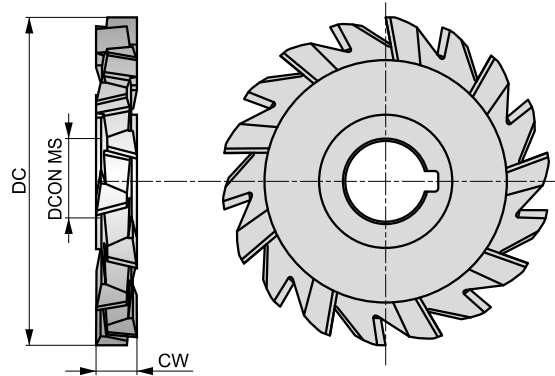

HSS-E	NOF 16-24	λ 15°
γ 10°	Bright	DC js16
DIN 885A		

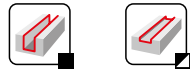

Workpiece material group suitability, starting values for cutting speed (m/min) and Alpha Code. Tables with feed per tooth and correction factors can be found starting from page 194.

P1.1 ■ 46 X	P1.2 ■ 52 X	P1.3 ■ 54 X	P2.1 ■ 40 X	P2.2 ■ 35 X	P2.3 ■ 31 X	P3.1 ■ 29 X	P3.2 ■ 24 X	P3.3 ■ 20 X	P4.1 ■ 18 X	P4.2 ■ 15 X	P4.3 ■ 12 X	M1.1 ■ 41 X	M1.2 ■ 35 X
M2.1 ■ 37 X	M2.2 ■ 30 X	M3.1 ■ 23 X	M3.2 ■ 20 X	M3.3 ■ 18 X	M4.1 ■ 10 X	K1.1 ■ 30 X	K1.2 ■ 22 X	K1.3 ■ 17 X	K2.1 ■ 49 X	K2.2 ■ 40 X	K2.3 ■ 32 X	K3.1 ■ 44 X	K3.2 ■ 33 X
K3.3 ■ 27 X	K4.1 ■ 40 X	K4.2 ■ 30 X	K4.3 ■ 22 X	K4.4 ■ 19 X	K4.5 ■ 16 X	K5.1 ■ 46 X	K5.2 ■ 34 X	K5.3 ■ 27 X	N1.1 ■ 83 X	N1.2 ■ 62 X	N1.3 ■ 42 X	N2.1 ■ 42 X	N2.2 ■ 37 X
N2.3 ■ 27 X	N3.1 ■ 44 X	N3.2 ■ 25 X	N3.3 ■ 13 X	N4.1 ■ 44 S	S1.1 ■ 30 V	S1.2 ■ 20 W	S1.3 ■ 15 W	S2.1 ■ 20 W	S2.2 ■ 14 S	S3.1 ■ 15 W	S3.2 ■ 10 S	S4.1 ■ 12 W	S4.2 ■ 8 S

Product	DC	CW	DCON MS	NOF
	[mm]	[mm]	[mm]	
D20050.0X4.0	50.00	4.0	16.00	16
D20050.0X5.0	50.00	5.0	16.00	16
D20063.0X6.0	63.00	6.0	22.00	18
D20063.0X8.0	63.00	8.0	22.00	18
D20080.0X6.0	80.00	6.0	27.00	20
D20080.0X8.0	80.00	8.0	27.00	20
D20080.0X10.0	80.00	10.0	27.00	18
D200100.0X8.0	100.00	8.0	32.00	22
D200100.0X10.0	100.00	10.0	32.00	22
D200100.0X12.0	100.00	12.0	32.00	20
D200100.0X14.0	100.00	14.0	32.00	20
D200100.0X16.0	100.00	16.0	32.00	20
D200125.0X10.0	125.00	10.0	32.00	24
D200125.0X12.0	125.00	12.0	32.00	22



D763



HSS-E Side and Face Fine Pitch Milling Cutter

Designed with a fine pitch, ideal for narrow, deep slots, where the staggered tooth geometry also helps control chips during milling. A very versatile tool which can be used for horizontal milling slots and parting-off applications. The bright finish prevents workpiece material from sticking to the cutting edges of the tool.

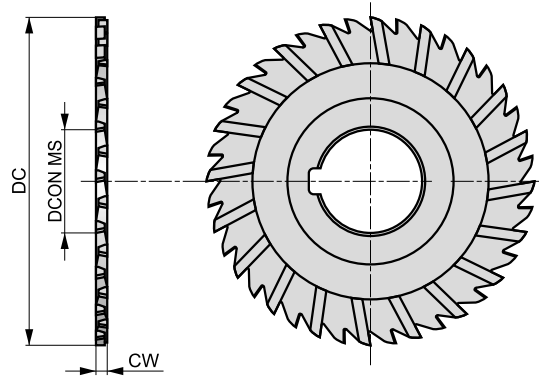

HSS-E	28-44 NOF	λ 15°
γ 10°	Bright	DC js16
DIN 885A		

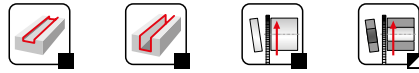

Workpiece material group suitability, starting values for cutting speed (m/min) and Alpha Code. Tables with feed per tooth and correction factors can be found starting from page 194.

P1.1 ■ 46 X	P1.2 ■ 52 X	P1.3 ■ 54 X	P2.1 ■ 40 X	P2.2 ■ 35 X	P2.3 ■ 31 X	P3.1 ■ 29 X	P3.2 ■ 24 X	P3.3 ■ 20 X	P4.1 ■ 18 X	P4.2 ■ 15 X	P4.3 ■ 12 X	M1.1 ■ 41 X	M1.2 ■ 35 X
M2.1 ■ 37 X	M2.2 ■ 30 X	M3.1 ■ 23 X	M3.2 ■ 20 X	M3.3 ■ 18 X	M4.1 ■ 10 X	K1.1 ■ 30 X	K1.2 ■ 22 X	K1.3 ■ 17 X	K2.1 ■ 49 X	K2.2 ■ 40 X	K2.3 ■ 32 X	K3.1 ■ 44 X	K3.2 ■ 33 X
K3.3 ■ 27 X	K4.1 ■ 40 X	K4.2 ■ 30 X	K4.3 ■ 22 X	K4.4 ■ 19 X	K4.5 ■ 16 X	K5.1 ■ 46 X	K5.2 ■ 34 X	K5.3 ■ 27 X	N1.1 ■ 83 X	N1.2 ■ 62 X	N1.3 ■ 42 X	N2.1 ■ 42 X	N2.2 ■ 37 X
N2.3 ■ 27 X	N3.1 ■ 44 X	N3.2 ■ 25 X	N3.3 ■ 13 X	N4.1 ■ 44 S	S1.1 ■ 30 V	S1.2 ■ 20 W	S1.3 ■ 15 W	S2.1 ■ 20 W	S2.2 ■ 14 S	S3.1 ■ 15 W	S3.2 ■ 10 S	S4.1 ■ 12 W	S4.2 ■ 8 S

Product	DC	CW	DCON MS	NOF
	[mm]	[mm]	[mm]	
D76363.0X1.6	63.00	1.6	22.00	32
D76363.0X2.0	63.00	2.0	22.00	32
D76363.0X2.5	63.00	2.5	22.00	32
D76363.0X3.0	63.00	3.0	22.00	28
D76363.0X3.5	63.00	3.5	22.00	28
D76380.0X2.0	80.00	2.0	27.00	36
D76380.0X2.5	80.00	2.5	27.00	36
D76380.0X3.0	80.00	3.0	27.00	32
D76380.0X3.5	80.00	3.5	27.00	32
D763100.0X2.0	100.00	2.0	32.00	44
D763100.0X3.0	100.00	3.0	32.00	40
D763125.0X2.0	125.00	2.0	32.00	44
D763125.0X3.0	125.00	3.0	32.00	44



D745



HSS Slitting Saw Coarse Pitch

Designed with a coarse pitch, ideal for narrow, deep slots, whilst the dish ground and neutral tooth geometry, helps control chips and prevents rubbing when milling deep slots. Suitable for horizontal milling of slots and parting-off applications. Bright finish.

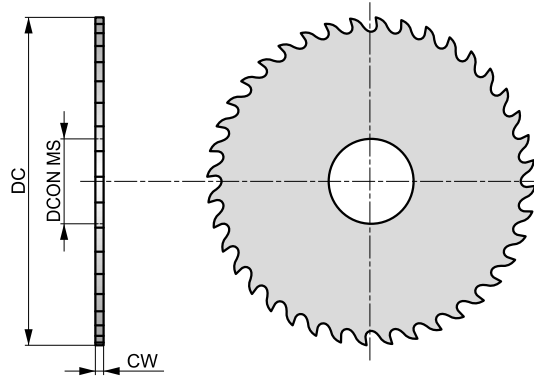

HSS		32-100 NOF
γ 15°	Bright	DIN 1838



Workpiece material group suitability, starting values for cutting speed (m/min) and Alpha Code. Tables with feed per tooth and correction factors can be found starting from page 194.

P1.1 ■ 40 Q	P1.2 ■ 45 Q	P1.3 ■ 46 Q	P2.1 ■ 34 Q	P2.2 ■ 30 Q	P3.1 ■ 29 P	P3.2 ■ 24 P	P4.1 ■ 18 P	M1.1 ▣ 14 P	M1.2 ▣ 12 P	M2.1 ▣ 12 P	M2.2 ▣ 10 P	M3.1 ▣ 12 P	M3.2 ▣ 10 P
K1.1 ■ 40 Q	K1.2 ■ 30 Q	K1.3 ■ 22 Q	K2.1 ■ 37 Q	K2.2 ■ 30 Q	K3.1 ■ 33 Q	K3.2 ■ 25 Q	K4.1 ■ 30 P	K4.2 ■ 23 P	K5.1 ■ 34 Q	K5.2 ■ 26 Q	N1.1 ■ 600 R	N1.2 ■ 450 R	N1.3 ■ 300 R
N2.1 ■ 769 R	N2.2 ■ 692 R	N2.3 ■ 500 R	N3.1 ■ 339 R	N3.2 ■ 200 R	N3.3 ■ 100 Q	N4.1 ■ 60 R							

Product	DC	CW	DCON MS	NOF
	[mm]	[mm]	[mm]	
D74550.0X.5	50.00	0.5	13.00	48
D74550.0X.6	50.00	0.6	13.00	48
D74550.0X.8	50.00	0.8	13.00	40
D74550.0X1.0	50.00	1.0	13.00	40
D74550.0X1.2	50.00	1.2	13.00	40
D74550.0X1.5	50.00	1.5	13.00	32
D74550.0X1.6	50.00	1.6	13.00	32
D74550.0X2.0	50.00	2.0	13.00	32
D74563.0X.5	63.00	0.5	16.00	64
D74563.0X.6	63.00	0.6	16.00	48
D74563.0X.8	63.00	0.8	16.00	48
D74563.0X1.0	63.00	1.0	16.00	48
D74563.0X1.2	63.00	1.2	16.00	40
D74563.0X1.5	63.00	1.5	16.00	40
D74563.0X1.6	63.00	1.6	16.00	40
D74563.0X2.0	63.00	2.0	16.00	40
D74580.0X1.0	80.00	1.0	22.00	48
D74580.0X1.2	80.00	1.2	22.00	48
D74580.0X1.5	80.00	1.5	22.00	48
D74580.0X1.6	80.00	1.6	22.00	48
D74580.0X2.0	80.00	2.0	22.00	40
D74580.0X2.5	80.00	2.5	22.00	40
D74580.0X3.0	80.00	3.0	22.00	40
D745100.0X1.0	100.00	1.0	22.00	64
D745100.0X1.2	100.00	1.2	22.00	64
D745100.0X1.5	100.00	1.5	22.00	48
D745100.0X1.6	100.00	1.6	22.00	48
D745100.0X2.0	100.00	2.0	22.00	48



Product	DC	CW	DCON MS	NOF
	[mm]	[mm]	[mm]	
D745100.0X2.5	100.00	2.5	22.00	48
D745100.0X3.0	100.00	3.0	22.00	40
D745100.0X4.0	100.00	4.0	22.00	40
D745125.0X1.0	125.00	1.0	22.00	80
D745125.0X1.2	125.00	1.2	22.00	64
D745125.0X1.5	125.00	1.5	22.00	64
D745125.0X1.6	125.00	1.6	22.00	64
D745125.0X2.0	125.00	2.0	22.00	64
D745125.0X2.5	125.00	2.5	22.00	48
D745125.0X3.0	125.00	3.0	22.00	48
D745125.0X4.0	125.00	4.0	22.00	48
D745160.0X1.6	160.00	1.6	32.00	80
D745160.0X2.0	160.00	2.0	32.00	64
D745160.0X2.5	160.00	2.5	32.00	64
D745160.0X3.0	160.00	3.0	32.00	64
D745160.0X4.0	160.00	4.0	32.00	48
D745200.0X1.6	200.00	1.6	32.00	80
D745200.0X2.0	200.00	2.0	32.00	80
D745200.0X2.5	200.00	2.5	32.00	80
D745200.0X3.0	200.00	3.0	32.00	64
D745200.0X4.0	200.00	4.0	32.00	64
D745250.0X2.0	250.00	2.0	32.00	100
D745250.0X2.5	250.00	2.5	32.00	80
D745250.0X3.0	250.00	3.0	32.00	80



D747

DORMER



HSS Slitting Saw Fine Pitch

Designed with a neutral tooth geometry to help control chips and prevent rubbing when milling deep slots. The fine pitch design makes it ideal for narrow, deep slots, and can be used for horizontal milling slots and parting-off applications. Bright finish.

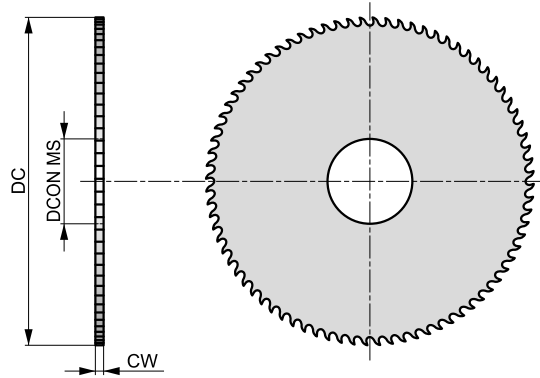

HSS		48-200 NOF
γ 5°	Bright	DIN 1837



Workpiece material group suitability, starting values for cutting speed (m/min) and Alpha Code. Tables with feed per tooth and correction factors can be found starting from page 194.

P1.1 ■ 40 Q	P1.2 ■ 45 Q	P1.3 ■ 46 Q	P2.1 ■ 34 Q	P2.2 ■ 30 Q	P3.1 ■ 29 P	P3.2 ■ 24 P	P4.1 ■ 18 P	M1.1 ▣ 14 P	M1.2 ▣ 12 P	M2.1 ▣ 12 P	M2.2 ▣ 10 P	M3.1 ▣ 12 P	M3.2 ▣ 10 P
K1.1 ■ 40 Q	K1.2 ■ 30 Q	K1.3 ■ 22 Q	K2.1 ■ 37 Q	K2.2 ■ 30 Q	K3.1 ■ 33 Q	K3.2 ■ 25 Q	K4.1 ■ 30 P	K4.2 ■ 23 P	K5.1 ■ 34 Q	K5.2 ■ 26 Q	N1.1 ■ 600 R	N1.2 ■ 450 R	N1.3 ■ 300 R
N2.1 ■ 769 R	N2.2 ■ 692 R	N2.3 ■ 500 R	N3.1 ■ 339 R	N3.2 ■ 200 R	N3.3 ■ 100 Q	N4.1 ■ 60 R							

Product	DC	CW	DCON MS	NOF
	[mm]	[mm]	[mm]	
D74732.0X.3	32.00	0.3	8.00	80
D74732.0X.4	32.00	0.4	8.00	80
D74732.0X.5	32.00	0.5	8.00	80
D74732.0X.6	32.00	0.6	8.00	64
D74732.0X.8	32.00	0.8	8.00	64
D74732.0X1.0	32.00	1.0	8.00	64
D74732.0X1.2	32.00	1.2	8.00	48
D74732.0X1.5	32.00	1.5	8.00	48
D74732.0X1.6	32.00	1.6	8.00	48
D74732.0X2.0	32.00	2.0	8.00	48
D74740.0X.3	40.00	0.3	10.00	100
D74740.0X.4	40.00	0.4	10.00	100
D74740.0X.5	40.00	0.5	10.00	80
D74740.0X.6	40.00	0.6	10.00	80
D74740.0X.8	40.00	0.8	10.00	80
D74740.0X1.0	40.00	1.0	10.00	64
D74740.0X1.2	40.00	1.2	10.00	64
D74740.0X1.5	40.00	1.5	10.00	64
D74740.0X1.6	40.00	1.6	10.00	64
D74740.0X2.0	40.00	2.0	10.00	48
D74750.0X.3	50.00	0.3	13.00	128
D74750.0X.4	50.00	0.4	13.00	100
D74750.0X.5	50.00	0.5	13.00	100
D74750.0X.6	50.00	0.6	13.00	100
D74750.0X.8	50.00	0.8	13.00	80
D74750.0X1.0	50.00	1.0	13.00	80
D74750.0X1.2	50.00	1.2	13.00	80
D74750.0X1.5	50.00	1.5	13.00	64



Product	DC	CW	DCON MS	NOF
	[mm]	[mm]	[mm]	
D74750.0X1.6	50.00	1.6	13.00	64
D74750.0X2.0	50.00	2.0	13.00	64
D74750.0X2.5	50.00	2.5	13.00	64
D74750.0X3.0	50.00	3.0	13.00	48
D74763.0X.5	63.00	0.5	16.00	128
D74763.0X.6	63.00	0.6	16.00	100
D74763.0X.8	63.00	0.8	16.00	100
D74763.0X1.0	63.00	1.0	16.00	100
D74763.0X1.2	63.00	1.2	16.00	80
D74763.0X1.5	63.00	1.5	16.00	80
D74763.0X1.6	63.00	1.6	16.00	80
D74763.0X2.0	63.00	2.0	16.00	80
D74763.0X2.5	63.00	2.5	16.00	64
D74763.0X3.0	63.00	3.0	16.00	64
D74763.0X4.0	63.00	4.0	16.00	64
D74780.0X.5	80.00	0.5	22.00	128
D74780.0X.6	80.00	0.6	22.00	128
D74780.0X.8	80.00	0.8	22.00	128
D74780.0X1.0	80.00	1.0	22.00	100
D74780.0X1.2	80.00	1.2	22.00	100
D74780.0X1.5	80.00	1.5	22.00	100
D74780.0X1.6	80.00	1.6	22.00	100
D74780.0X2.0	80.00	2.0	22.00	80
D74780.0X2.5	80.00	2.5	22.00	80
D74780.0X3.0	80.00	3.0	22.00	80
D74780.0X4.0	80.00	4.0	22.00	64
D747100.0X.5	100.00	0.5	22.00	160
D747100.0X.6	100.00	0.6	22.00	160
D747100.0X.8	100.00	0.8	22.00	128
D747100.0X1.0	100.00	1.0	22.00	128
D747100.0X1.2	100.00	1.2	22.00	128
D747100.0X1.5	100.00	1.5	22.00	100
D747100.0X1.6	100.00	1.6	22.00	100
D747100.0X2.0	100.00	2.0	22.00	100
D747100.0X2.5	100.00	2.5	22.00	100
D747100.0X3.0	100.00	3.0	22.00	80
D747100.0X4.0	100.00	4.0	22.00	80
D747125.0X1.0	125.00	1.0	22.00	160
D747125.0X1.2	125.00	1.2	22.00	128
D747125.0X1.5	125.00	1.5	22.00	128
D747125.0X1.6	125.00	1.6	22.00	128
D747125.0X2.0	125.00	2.0	22.00	128
D747125.0X2.5	125.00	2.5	22.00	100
D747125.0X3.0	125.00	3.0	22.00	100
D747125.0X4.0	125.00	4.0	22.00	100
D747160.0X1.0	160.00	1.0	32.00	160
D747160.0X1.2	160.00	1.2	32.00	160
D747160.0X1.5	160.00	1.5	32.00	160
D747160.0X1.6	160.00	1.6	32.00	160
D747160.0X2.0	160.00	2.0	32.00	128
D747160.0X2.5	160.00	2.5	32.00	128
D747160.0X3.0	160.00	3.0	32.00	128
D747160.0X4.0	160.00	4.0	32.00	100
D747160.0X5.0	160.00	5.0	32.00	100
D747200.0X1.0	200.00	1.0	32.00	200
D747200.0X1.2	200.00	1.2	32.00	200
D747200.0X2.0	200.00	2.0	32.00	160
D747200.0X3.0	200.00	3.0	32.00	128



D752



HSS Slitting Saw Coarse Pitch

Designed with coarse pitch, ideal for thin section components. The dish ground and neutral tooth geometry, in addition to helping control chips, also prevents rubbing when slitting tubes and pipes. Suitable for slitting and cutting. The steam oxide finish acts to retain cutting fluid and prevent chip tool welding.

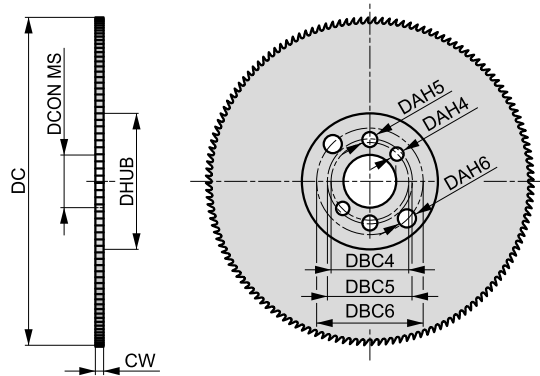

HSS		110-180 NOF
γ 18°	ST	DORMER



Workpiece material group suitability, starting values for cutting speed (m/min) and Alpha Code. Tables with feed per tooth and correction factors can be found starting from page 194.

P1.1 ■ 40 Q	P1.2 ■ 45 Q	P1.3 ■ 46 Q	P2.1 ■ 34 Q	P2.2 ■ 30 Q	P3.1 ■ 29 P	P3.2 ■ 24 P	P4.1 ■ 18 P	M1.1 ▣ 14 P	M1.2 ▣ 12 P	M2.1 ▣ 12 P	M2.2 ▣ 10 P	M3.1 ▣ 12 P	M3.2 ▣ 10 P
K1.1 ■ 40 Q	K1.2 ■ 30 Q	K1.3 ■ 22 Q	K2.1 ■ 37 Q	K2.2 ■ 30 Q	K3.1 ■ 33 Q	K3.2 ■ 25 Q	K4.1 ■ 30 P	K4.2 ■ 23 P	K5.1 ■ 34 Q	K5.2 ■ 26 Q	N1.1 ■ 600 R	N1.2 ■ 450 R	N1.3 ■ 300 R
N2.1 ■ 769 R	N2.2 ■ 692 R	N2.3 ■ 500 R	N3.1 ■ 339 R	N3.2 ■ 200 R	N3.3 ■ 100 Q	N4.1 ■ 60 R							

Product	DC	CW	DCON MS	NOF	P	DHUB	DAH4	DBC4	DAH5	DBC5	DAH6	DBC6
	[mm]	[mm]	[mm]		[mm]	[mm]	[mm]	[mm]	[mm]	[mm]	[mm]	[mm]
D752250.0X2.0X128	250.00	2.0	32.00	128	6	100	8	45	9	50	11	63
D752275.0X2.5X110	275.00	2.5	32.00	110	8	100	8	45	9	50	11	63
D752300.0X2.5X160	300.00	2.5	32.00	160	6	100	8	45	9	50	11	63
D752315.0X2.5X160	315.00	2.5	32.00	160	6	100	8	45	9	50	11	63
D752350.0X2.5X180	350.00	2.5	32.00	180	6	120	8	45	9	50	11	63



D753



HSS Slitting Saw Coarse Pitch

Designed with coarse pitch, ideal for thin section components. The dish ground and neutral tooth geometry, in addition to helping control chips, also prevents rubbing when slitting tubes and pipes. Suitable for slitting and cutting. The steam oxide finish acts to retain cutting fluid and prevent chip tool welding.

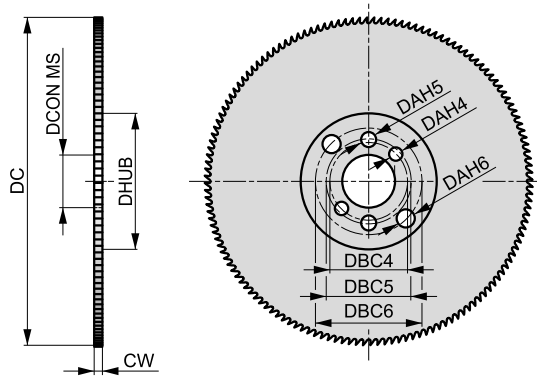

HSS		100-140 NOF
18°	ST	DORMER



Workpiece material group suitability, starting values for cutting speed (m/min) and Alpha Code. Tables with feed per tooth and correction factors can be found starting from page 194.

P1.1 ■ 40 Q	P1.2 ■ 45 Q	P1.3 ■ 46 Q	P2.1 ■ 34 Q	P2.2 ■ 30 Q	P3.1 ■ 29 P	P3.2 ■ 24 P	P4.1 ■ 18 P	M1.1 ▣ 14 P	M1.2 ▣ 12 P	M2.1 ▣ 12 P	M2.2 ▣ 10 P	M3.1 ▣ 12 P	M3.2 ▣ 10 P
K1.1 ■ 40 Q	K1.2 ■ 30 Q	K1.3 ■ 22 Q	K2.1 ■ 37 Q	K2.2 ■ 30 Q	K3.1 ■ 33 Q	K3.2 ■ 25 Q	K4.1 ■ 30 P	K4.2 ■ 23 P	K5.1 ■ 34 Q	K5.2 ■ 26 Q	N1.1 ■ 600 R	N1.2 ■ 450 R	N1.3 ■ 300 R
N2.1 ■ 769 R	N2.2 ■ 692 R	N2.3 ■ 500 R	N3.1 ■ 339 R	N3.2 ■ 200 R	N3.3 ■ 100 Q	N4.1 ■ 60 R							

Product	DC	CW	DCON MS	NOF	P	DHUB	DAH4	DBC4	DAH5	DBC5	DAH6	DBC6
	[mm]	[mm]	[mm]		[mm]	[mm]	[mm]	[mm]	[mm]	[mm]	[mm]	[mm]
D753250.0X2.0	250.00	2.0	32.00	100	8	100	8	45	9	50	11	63
D753300.0X2.5	300.00	2.5	32.00	120	8	100	8	45	9	50	11	63
D753315.0X2.5	315.00	2.5	32.00	120	8	100	8	45	9	50	11	63
D753350.0X2.5	350.00	2.5	32.00	140	8	120	8	45	9	50	11	63



D750



HSS Slitting Saw Fine Pitch

Designed with fine pitch, ideal for thin section components. Suitable for slitting and cutting. With ranges from 130 to 220 teeth, the neutral tooth geometry helps control chips and prevents rubbing when slitting tubes and pipes. The steam oxide finish acts to retain cutting fluid and prevent chip tool welding.

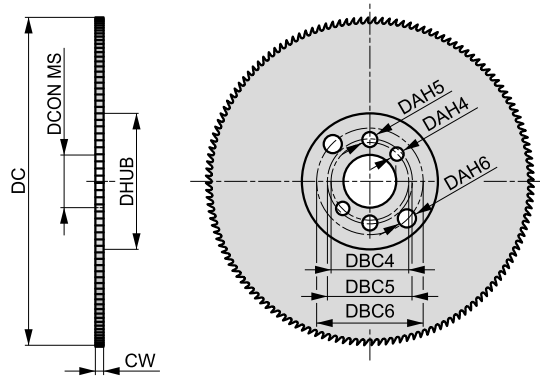

HSS		130-220 NOF
18°	ST	DORMER



Workpiece material group suitability, starting values for cutting speed (m/min) and Alpha Code. Tables with feed per tooth and correction factors can be found starting from page 194.

P1.1 ■ 40 Q	P1.2 ■ 45 Q	P1.3 ■ 46 Q	P2.1 ■ 34 Q	P2.2 ■ 30 Q	P3.1 ■ 29 P	P3.2 ■ 24 P	P4.1 ■ 18 P	M1.1 ▣ 14 P	M1.2 ▣ 12 P	M2.1 ▣ 12 P	M2.2 ▣ 10 P	M3.1 ▣ 12 P	M3.2 ▣ 10 P
K1.1 ■ 40 Q	K1.2 ■ 30 Q	K1.3 ■ 22 Q	K2.1 ■ 37 Q	K2.2 ■ 30 Q	K3.1 ■ 33 Q	K3.2 ■ 25 Q	K4.1 ■ 30 P	K4.2 ■ 23 P	K5.1 ■ 34 Q	K5.2 ■ 26 Q	N1.1 ■ 600 R	N1.2 ■ 450 R	N1.3 ■ 300 R
N2.1 ■ 769 R	N2.2 ■ 692 R	N2.3 ■ 500 R	N3.1 ■ 339 R	N3.2 ■ 200 R	N3.3 ■ 100 Q	N4.1 ■ 60 R							

Product	DC	CW	DCON MS	NOF	P	DHUB	DAH4	DBC4	DAH5	DBC5	DAH6	DBC6
	[mm]	[mm]	[mm]		[mm]	[mm]	[mm]	[mm]	[mm]	[mm]	[mm]	[mm]
D750200.0X1.8	200.00	1.8	32.00	130	5	100	8	45	9	50	11	63
D750225.0X2.0	225.00	2.0	32.00	140	5	100	8	45	9	50	11	63
D750250.0X2.0	250.00	2.0	32.00	160	5	100	8	45	9	50	11	63
D750275.0X2.5	275.00	2.5	32.00	180	5	100	8	45	9	50	11	63
D750300.0X2.5	300.00	2.5	32.00	180	5	100	8	45	9	50	11	63
D750315.0X2.5	315.00	2.5	32.00	200	5	100	8	45	9	50	11	63
D750350.0X2.5	350.00	2.5	32.00	220	5	120	8	45	9	59	11	63



D751



HSS Slitting Saw Fine Pitch

Designed with fine pitch, ideal for thin section components. Suitable for slitting and cutting. With ranges from 160 to 350 teeth, the neutral tooth geometry helps control chips and prevents rubbing when slitting tubes and pipes. The steam oxide finish acts to retain cutting fluid and prevent chip tool welding.

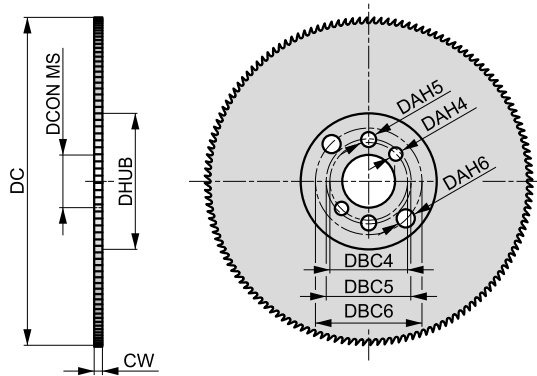

HSS		160-350 NOF
18°	ST	DORMER



Workpiece material group suitability, starting values for cutting speed (m/min) and Alpha Code. Tables with feed per tooth and correction factors can be found starting from page 194.

P1.1 ■ 40 Q	P1.2 ■ 45 Q	P1.3 ■ 46 Q	P2.1 ■ 34 Q	P2.2 ■ 30 Q	P3.1 ■ 29 P	P3.2 ■ 24 P	P4.1 ■ 18 P	M1.1 ▣ 14 P	M1.2 ▣ 12 P	M2.1 ▣ 12 P	M2.2 ▣ 10 P	M3.1 ▣ 12 P	M3.2 ▣ 10 P
K1.1 ■ 40 Q	K1.2 ■ 30 Q	K1.3 ■ 22 Q	K2.1 ■ 37 Q	K2.2 ■ 30 Q	K3.1 ■ 33 Q	K3.2 ■ 25 Q	K4.1 ■ 30 P	K4.2 ■ 23 P	K5.1 ■ 34 Q	K5.2 ■ 26 Q	N1.1 ■ 600 R	N1.2 ■ 450 R	N1.3 ■ 300 R
N2.1 ■ 769 R	N2.2 ■ 692 R	N2.3 ■ 500 R	N3.1 ■ 339 R	N3.2 ■ 200 R	N3.3 ■ 100 Q	N4.1 ■ 60 R							

Product	DC	CW	DCON MS	NOF	P	DHUB	DAH4	DBC4	DAH5	DBC5	DAH6	DBC6
	[mm]	[mm]	[mm]		[mm]	[mm]	[mm]	[mm]	[mm]	[mm]	[mm]	[mm]
D751200.0X1.8X160	200.00	1.8	32.00	160	4	100	8	45	9	50	11	63
D751200.0X1.8X200	200.00	1.8	32.00	200	3	100	8	45	9	50	11	63
D751225.0X2.0X180	225.00	2.0	32.00	180	4	100	8	45	9	50	11	63
D751225.0X2.0X220	225.00	2.0	32.00	220	3	100	8	45	9	50	11	63
D751250.0X2.0X200	250.00	2.0	32.00	200	4	100	8	45	9	50	11	63
D751250.0X2.0X250	250.00	2.0	32.00	250	3	100	8	45	9	50	11	63
D751275.0X2.5X220	275.00	2.5	32.00	220	4	100	8	45	9	50	11	63
D751275.0X2.5X280	275.00	2.5	32.00	280	3	100	8	45	9	50	11	63
D751300.0X2.5X220	300.00	2.5	32.00	220	4	100	8	45	9	50	11	63
D751300.0X2.5X300	300.00	2.5	32.00	300	3	100	8	45	9	50	11	63
D751315.0X2.5X240	315.00	2.5	32.00	240	4	100	8	45	9	50	11	63
D751315.0X2.5X320	315.00	2.5	32.00	320	3	100	8	45	9	50	11	63
D751350.0X2.5X280	350.00	2.5	32.00	280	4	120	8	45	9	50	11	63
D751350.0X2.5X350	350.00	2.5	32.00	350	3	120	8	45	9	50	11	63



D400



HSS-E Shell Cutter, Bright Finish

The standard bore sizes make it suitable for shell mill holders with a large diameter available up to 63 mm. Suitable for slotting and cutting. Bright finish.

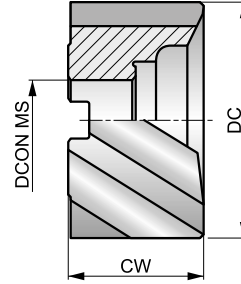
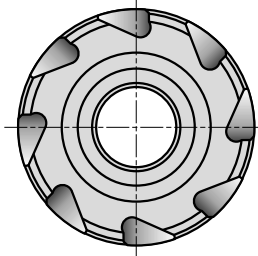

HSS-E	N	NOF 8
λ 30°	γ 12°	Bright
DC js16		DIN 1880

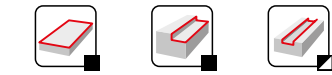

Workpiece material group suitability, starting values for cutting speed (m/min) and Alpha Code. Tables with feed per tooth and correction factors can be found starting from page 194.

P1.1 ■ 40 C	P1.2 ■ 45 C	P1.3 ■ 46 C	P2.1 ■ 34 C	P2.2 ■ 30 C	P2.3 ▧ 27 B	P3.1 ■ 29 C	P3.2 ■ 24 B	P3.3 ▧ 20 B	P4.1 ■ 18 B	P4.2 ▧ 15 B	P4.3 ▧ 12 B	M1.1 ■ 34 C	M1.2 ■ 29 C
M2.1 ■ 31 C	M2.2 ■ 25 B	M3.1 ▧ 17 B	M3.2 ▧ 15 B	M3.3 ■ 14 A	M4.1 ■ 10 A	K1.1 ■ 20 C	K1.2 ■ 15 C	K1.3 ■ 11 C	K2.1 ■ 37 C	K2.2 ■ 30 C	K2.3 ■ 24 B	K3.1 ■ 33 C	K3.2 ■ 25 C
K3.3 ■ 20 A	K4.1 ■ 30 B	K4.2 ■ 23 B	K4.3 ■ 17 B	K4.4 ■ 14 A	K4.5 ■ 12 A	K5.1 ■ 34 B	K5.2 ■ 26 B	K5.3 ■ 20 B	N1.1 ▧ 76 E	N1.2 ▧ 57 D	N1.3 ■ 38 D	N2.1 ■ 38 C	N2.2 ■ 34 C
N2.3 ■ 25 C	N3.1 ■ 40 C	N3.2 ■ 23 C	N3.3 ■ 12 C	N4.1 ▧ 40 C	N4.2 ▧ 15 C	N4.3 ▧ 17 C	S1.1 ■ 30 B	S1.2 ▧ 20 B	S1.3 ▧ 10 A	S2.1 ▧ 13 A	S2.2 ▧ 17 A	S3.1 ▧ 10 A	S3.2 ▧ 15 A
S4.1 ▧ 8 A	S4.2 ▧ 4 A												

Product	DC	CW	DCON MS	NOF
	[mm]	[mm]	[mm]	
D40040.0	40.00	32.0	16.00	8
D40050.0	50.00	36.0	22.00	8
D40063.0	63.00	40.0	27.00	8



D420

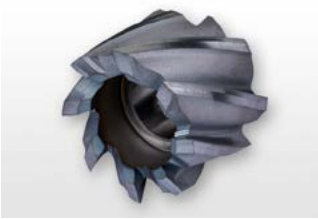

HSS-E Shell Cutter, TiCN Coating

The standard bore sizes make it suitable for standard shell mill holders and can be used for slotting and cutting. Available in a large range of sizes, with diameters up to 63 mm available. TiCN coating increases the life of the cutter and improves performance when milling hard and abrasive materials.

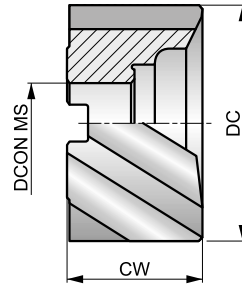
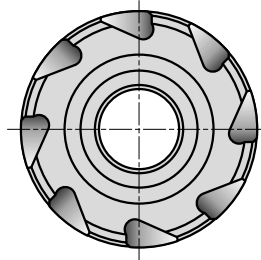

HSS-E	N	NOF 8
λ 30°	γ 12°	TiCN
DC js16		DIN 1880

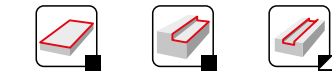

Workpiece material group suitability, starting values for cutting speed (m/min) and Alpha Code. Tables with feed per tooth and correction factors can be found starting from page 194.

P1.1 ■ 86 C	P1.2 ■ 96 C	P1.3 ■ 100 C	P2.1 ■ 74 C	P2.2 ■ 65 C	P2.3 ■ 57 B	P3.1 ■ 52 C	P3.2 ■ 42 B	P3.3 ■ 35 B	P4.1 ■ 31 B	P4.2 ■ 26 B	P4.3 ■ 21 B	M1.1 ■ 48 C	M1.2 ■ 41 C
M2.1 ■ 43 C	M2.2 ■ 35 B	M3.1 ■ 35 B	M3.2 ■ 30 B	M3.3 ■ 27 A	M4.1 ■ 20 A	K1.1 ■ 35 C	K1.2 ■ 26 C	K1.3 ■ 19 C	K2.1 ■ 62 C	K2.2 ■ 50 C	K2.3 ■ 40 B	K3.1 ■ 54 C	K3.2 ■ 42 C
K3.3 ■ 34 A	K4.1 ■ 50 B	K4.2 ■ 38 B	K4.3 ■ 28 B	K4.4 ■ 24 A	K4.5 ■ 20 A	K5.1 ■ 57 B	K5.2 ■ 43 B	K5.3 ■ 33 B	N1.1 ▣ 159 E	N1.2 ▣ 120 D	N1.3 ■ 80 D	N2.1 ■ 80 C	N2.2 ■ 72 C
N2.3 ■ 51 C	N3.1 ■ 84 C	N3.2 ■ 50 C	N3.3 ■ 25 C	N4.1 ■ 84 C	N4.2 ▣ 32 C	N4.3 ▣ 35 C	S1.1 ■ 35 B	S1.2 ■ 25 B	S1.3 ■ 15 A	S2.1 ■ 27 A	S2.2 ■ 14 A	S3.1 ■ 20 A	S3.2 ■ 10 A
S4.1 ■ 16 A	S4.2 ■ 8 A												

Product	DC [mm]	CW [mm]	DCON MS [mm]	NOF
D42040.0	40.00	32.0	16.00	8
D42050.0	50.00	36.0	22.00	8
D42063.0	63.00	40.0	27.00	8



D402



HSS-E Roughing Shell Mill Cutter, Bright Finish

Designed with a coarse pitch NR roughing profile, the tools are suitable for high metal removal roughing applications. The standard bore makes it possible to be used with standard shell end mill holders. Bright finish.

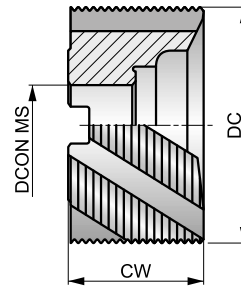
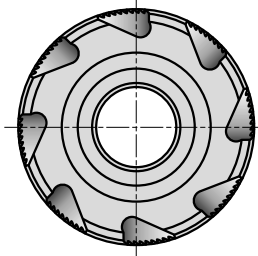

HSS-E	NR	NOF 6-8
λ 30°	γ 12°	Bright
DC js16		DIN 1880

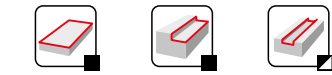

Workpiece material group suitability, starting values for cutting speed (m/min) and Alpha Code. Tables with feed per tooth and correction factors can be found starting from page 194.

P1.1 ■ 40 D	P1.2 ■ 45 D	P1.3 ■ 46 D	P2.1 ■ 34 D	P2.2 ■ 30 D	P2.3 ▧ 27 C	P3.1 ■ 29 D	P3.2 ■ 24 C	P3.3 ▧ 20 C	P4.1 ■ 18 C	P4.2 ▧ 15 C	P4.3 ▧ 12 C	M1.1 ■ 34 D	M1.2 ■ 29 D
M2.1 ■ 31 D	M2.2 ■ 25 C	M3.1 ▧ 17 C	M3.2 ▧ 15 C	M3.3 ■ 14 B	M4.1 ■ 10 B	K1.1 ■ 20 D	K1.2 ■ 15 D	K1.3 ■ 11 D	K2.1 ■ 37 D	K2.2 ■ 30 D	K2.3 ■ 24 C	K3.1 ■ 33 D	K3.2 ■ 25 D
K3.3 ■ 20 B	K4.1 ■ 30 C	K4.2 ■ 23 C	K4.3 ■ 17 C	K4.4 ■ 14 B	K4.5 ■ 12 B	K5.1 ■ 34 C	K5.2 ■ 26 C	K5.3 ■ 20 C	N1.1 ▧ 76 F	N1.2 ▧ 57 E	N1.3 ■ 38 E	N2.1 ■ 38 D	N2.2 ■ 34 D
N2.3 ■ 25 D	N3.1 ■ 40 D	N3.2 ■ 23 D	N3.3 ■ 12 D	N4.1 ▧ 40 D	N4.2 ▧ 15 D	N4.3 ▧ 17 D	S1.1 ■ 30 C	S1.2 ▧ 20 C	S1.3 ▧ 10 B	S2.1 ▧ 13 B	S2.2 ▧ 7 B	S3.1 ▧ 10 B	S3.2 ▧ 5 B
S4.1 ▧ 8 B	S4.2 ▧ 4 B												

Product	DC	CW	DCON MS	NOF
	[mm]	[mm]	[mm]	
D40240.0	40.00	32.0	16.00	6
D40250.0	50.00	36.0	22.00	6
D40263.0	63.00	40.0	27.00	8



D422

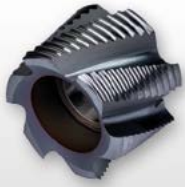

HSS-E Roughing Shell Cutter, TiCN Coating

Designed with a coarse pitch NR roughing profile for high metal removal. With standard bore sizes which can be held in standard shell mill holders, the end mills are suitable for roughing applications. TiCN coating increases the life of the cutter and improves performance when milling hard and abrasive materials.

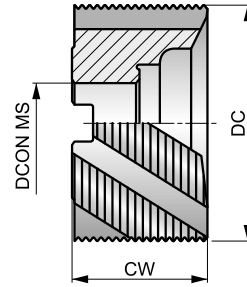
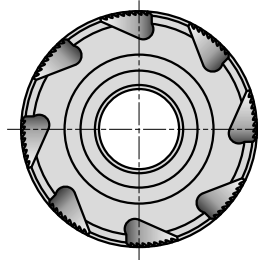

HSS-E	NR	NOF 6-8
λ 30°	γ 12°	TiCN
DC js16		DIN 1880

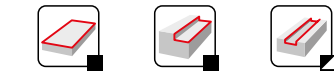

Workpiece material group suitability, starting values for cutting speed (m/min) and Alpha Code. Tables with feed per tooth and correction factors can be found starting from page 194.

P1.1 ■ 86 D	P1.2 ■ 96 D	P1.3 ■ 100 D	P2.1 ■ 74 D	P2.2 ■ 65 D	P2.3 ■ 57 C	P3.1 ■ 52 D	P3.2 ■ 42 C	P3.3 ■ 35 C	P4.1 ■ 31 C	P4.2 ■ 26 C	P4.3 ■ 21 C	M1.1 ■ 48 D	M1.2 ■ 41 D
M2.1 ■ 43 D	M2.2 ■ 35 C	M3.1 ■ 35 C	M3.2 ■ 30 C	M3.3 ■ 27 B	M4.1 ■ 20 B	K1.1 ■ 35 D	K1.2 ■ 26 D	K1.3 ■ 19 D	K2.1 ■ 62 D	K2.2 ■ 50 D	K2.3 ■ 40 C	K3.1 ■ 54 D	K3.2 ■ 42 D
K3.3 ■ 34 B	K4.1 ■ 50 C	K4.2 ■ 38 C	K4.3 ■ 28 C	K4.4 ■ 24 B	K4.5 ■ 20 B	K5.1 ■ 57 C	K5.2 ■ 43 C	K5.3 ■ 33 C	N1.1 ■ 159 F	N1.2 ■ 120 E	N1.3 ■ 80 E	N2.1 ■ 80 D	N2.2 ■ 72 D
N2.3 ■ 51 D	N3.1 ■ 84 D	N3.2 ■ 50 D	N3.3 ■ 25 D	N4.1 ■ 84 D	N4.2 ■ 32 D	N4.3 ■ 35 D	S1.1 ■ 35 C	S1.2 ■ 25 C	S1.3 ■ 15 B	S2.1 ■ 27 B	S2.2 ■ 14 B	S3.1 ■ 20 B	S3.2 ■ 10 B
S4.1 ■ 16 B	S4.2 ■ 8 B												

Product	DC [mm]	CW [mm]	DCON MS [mm]	NOF
D42240.0	40.00	32.0	16.00	6
D42250.0	50.00	36.0	22.00	6
D42263.0	63.00	40.0	27.00	8



SOLID HSS MILLS – FEED PER TOOTH TABLE

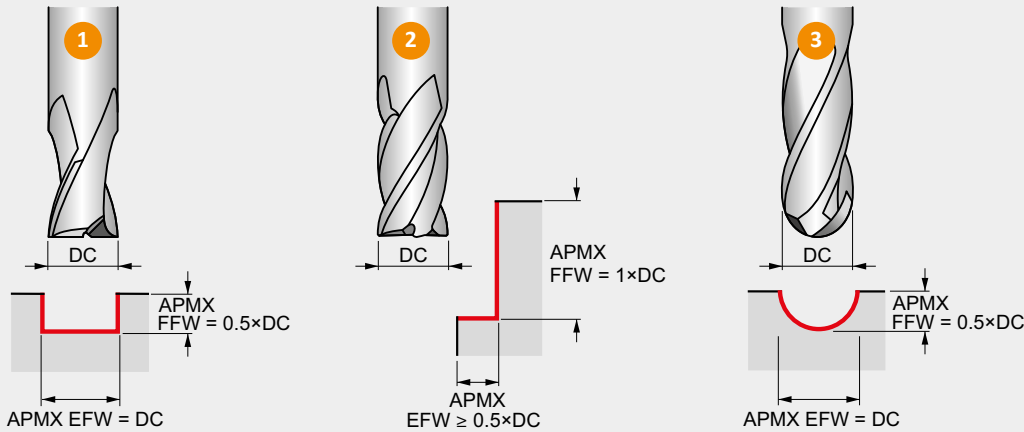

Feed per tooth (f_z in mm/rev) depending on the working conditions it might be necessary to adjust these values $\pm 25\%$.

ONLY if plunging into solid material with a centre cutting end mill the values in this table should be considered as f_n (feed per revolution).

How to use this table to find the feed per tooth (f_z):

1. Find your Alpha Code on the product page (example: 48C, "C" is the Alpha Code).
2. Find the closest diameter for your cutting application in the top row of the table.
3. Find your Alpha Code in the left column of the table.
4. The intersection (cell) of the Diameter and Alpha Code is the feed per tooth (f_z).

**FOR HSS,
HSS-E AND
HSS-E-PM MILLING
CUTTERS ONLY**

		ϕ DC [mm]																		
		1.00	2.00	3.00	4.00	5.00	6.00	8.00	10.00	12.00	16.00	20.00	25.00	28.00	32.00	36.00	40.00	63.00	80.00	100.00
Feed rates	A	0.002	0.003	0.003	0.005	0.005	0.005	0.007	0.009	0.011	0.015	0.018	0.023	0.027	0.030	0.033	0.034	0.043	0.045	0.042
	B	0.003	0.004	0.004	0.006	0.006	0.007	0.009	0.012	0.014	0.018	0.023	0.029	0.033	0.038	0.041	0.043	0.054	0.057	0.052
	C	0.004	0.004	0.005	0.007	0.008	0.008	0.011	0.015	0.017	0.023	0.029	0.036	0.042	0.047	0.051	0.054	0.067	0.071	0.065
	D	0.005	0.006	0.006	0.009	0.010	0.010	0.014	0.018	0.022	0.029	0.036	0.045	0.052	0.059	0.064	0.067	0.084	0.089	0.082
	E	0.006	0.007	0.008	0.011	0.012	0.013	0.017	0.023	0.027	0.036	0.045	0.056	0.065	0.074	0.080	0.084	0.105	0.111	0.102
	F	0.007	0.008	0.010	0.013	0.014	0.016	0.020	0.028	0.032	0.043	0.054	0.067	0.078	0.089	0.096	0.101	0.126	0.133	0.122
	G	0.009	0.010	0.012	0.016	0.017	0.019	0.024	0.033	0.039	0.052	0.065	0.081	0.094	0.107	0.115	0.121	0.151	0.160	0.147
	H	0.010	0.012	0.014	0.019	0.021	0.022	0.029	0.040	0.047	0.062	0.078	0.097	0.112	0.128	0.138	0.145	0.181	0.192	0.176
	I	0.012	0.015	0.017	0.023	0.025	0.027	0.035	0.048	0.056	0.075	0.093	0.116	0.135	0.153	0.166	0.174	0.218	0.230	0.212
	J	0.015	0.017	0.020	0.027	0.030	0.032	0.042	0.057	0.067	0.090	0.112	0.139	0.162	0.184	0.199	0.209	0.261	0.276	0.254

This table is valid for end mills and shell mills.



SOLID HSS MILLS – FEED PER TOOTH TABLE

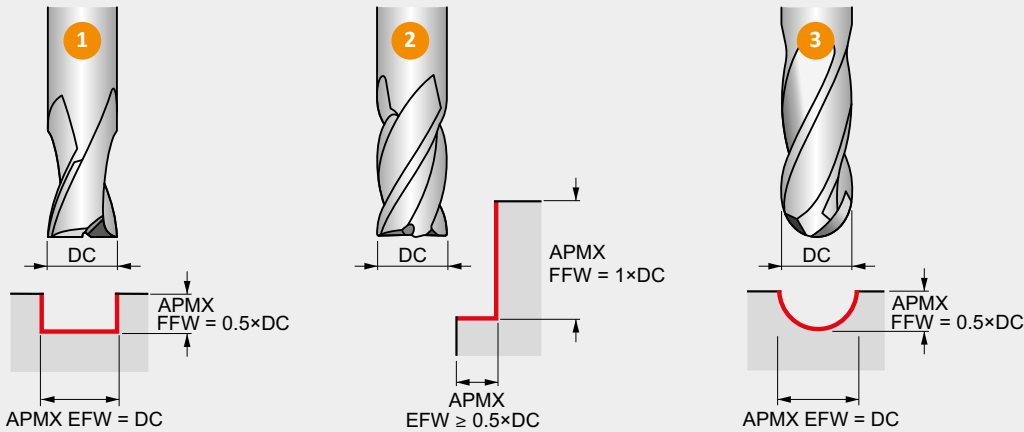

Feed per tooth (IPT or inch/tooth) depending on the working conditions it might be necessary to adjust these values $\pm 25\%$.

ONLY if plunging into solid material with a centre cutting end mill the values in this table should be considered as IPR (feed in inch per revolution).

How to use this table to find the feed per tooth (IPT):

1. Find your Alpha Code on the product page (example: 157C, "C" is the Alpha Code).
2. Find the closest diameter for your cutting application in the top row of the table.
3. Find your Alpha Code in the left column of the table.
4. The intersection (cell) of the Diameter and Alpha Code is the feed per tooth (IPT).

**FOR HSS,
HSS-E AND
HSS-E-PM MILLING
CUTTERS ONLY**

		ø DC [inch]																			
		1/16	3/32	1/8	5/32	3/16	7/32	1/4	5/16	3/8	7/16	1/2	9/16	5/8	3/4	7/8	1	1 1/8	1 1/4	1 1/2	
Feed rates		.0625	.0938	.1250	.1563	.1875	.2188	.2500	.3125	.3750	.4375	.5000	.5625	.6250	.7500	.8750	1,0000	1,1250	1,2500	1,5000	
	A	.0001	.0001	.0001	.0002	.0002	.0002	.0002	.0003	.0004	.0004	.0005	.0006	.0006	.0007	.0008	.0009	.0011	.0012	.0015	.0017
	B	.0001	.0002	.0002	.0002	.0002	.0002	.0003	.0004	.0004	.0005	.0006	.0007	.0007	.0009	.0011	.0012	.0014	.0015	.0017	.0017
	C	.0002	.0002	.0002	.0003	.0003	.0003	.0004	.0004	.0005	.0006	.0007	.0008	.0009	.0011	.0013	.0015	.0017	.0019	.0020	.0020
	D	.0002	.0002	.0002	.0004	.0004	.0004	.0004	.0006	.0007	.0008	.0009	.0010	.0011	.0013	.0017	.0019	.0021	.0023	.0026	.0026
	E	.0002	.0003	.0003	.0004	.0005	.0005	.0006	.0007	.0008	.0010	.0011	.0013	.0014	.0017	.0020	.0023	.0027	.0029	.0032	.0032
	F	.0003	.0003	.0004	.0005	.0006	.0006	.0007	.0008	.0010	.0012	.0014	.0016	.0017	.0020	.0024	.0028	.0032	.0035	.0039	.0039
	G	.0004	.0004	.0005	.0006	.0007	.0007	.0008	.0009	.0012	.0014	.0017	.0019	.0020	.0024	.0030	.0033	.0039	.0042	.0046	.0046
	H	.0004	.0005	.0006	.0007	.0008	.0008	.0009	.0011	.0014	.0017	.0020	.0022	.0024	.0029	.0035	.0040	.0046	.0050	.0056	.0056
	I	.0005	.0006	.0007	.0009	.0010	.0010	.0011	.0014	.0017	.0020	.0024	.0027	.0030	.0035	.0043	.0048	.0056	.0060	.0067	.0067
	J	.0006	.0007	.0008	.0011	.0012	.0012	.0014	.0017	.0020	.0024	.0028	.0032	.0035	.0042	.0051	.0058	.0067	.0072	.0080	.0080

This table is valid for end mills and shell mills.



SOLID HSS MILLS – CORRECTION FACTORS

1 Slot Milling

Correction factors for cutting speed v_c and feed per tooth f_z for slot milling operations at different depths of cut.

APMX FFW / DC	25%	50%	100%	150%
	1.25	1.00	0.75	0.50
	1.25	1.00	0.75	0.50

2 Shoulder Milling

Correction factors for cutting speed v_c and feed per tooth f_z for square shoulder milling with < 50% radial immersion.

APMX EFW / DC	5%	10%	15%	20%	25%	30%	40%	≥ 50%
	1.48	1.35	1.27	1.22	1.19	1.16	1.11	1.00
	2.29	1.67	1.40	1.25	1.15	1.09	1.02	1.00

We recommend to avoid milling with 50% radial immersion.

3a Plain Copy Milling (with Ball Nose Cutters)

Correction factors for cutting speed v_c for plain copy milling at different depths of cut.

APMX FFW / DC	5%	10%	15%	20%	25%	30%	40%	50%
	2.29	1.67	1.40	1.25	1.15	1.09	1.02	1.00

3b

Line offset f_e (step-over distance) for achieving a theoretical surface roughness R_{th} .

DC	μm	2	4	8	16	32	63	125	250
2		0.13	0.18	0.25	0.36	0.50	0.70	0.97	1.32
3		0.15	0.22	0.31	0.44	0.62	0.86	1.20	1.66
4		0.18	0.25	0.36	0.50	0.71	1.00	1.39	1.94
5		0.20	0.28	0.40	0.56	0.80	1.12	1.56	2.18
6		0.22	0.31	0.44	0.62	0.87	1.22	1.71	2.40
8		0.25	0.36	0.51	0.71	1.01	1.41	1.98	2.78
10		0.28	0.40	0.57	0.80	1.13	1.58	2.22	3.12
12		0.31	0.44	0.62	0.88	1.24	1.73	2.44	3.43
14		0.33	0.47	0.67	0.95	1.34	1.87	2.63	3.71
16		0.36	0.51	0.72	1.01	1.43	2.00	2.82	3.97
18		0.38	0.54	0.76	1.07	1.52	2.13	2.99	4.21
20		0.40	0.57	0.80	1.13	1.60	2.24	3.15	4.44
22		0.42	0.59	0.84	1.19	1.68	2.35	3.31	4.66
25		0.45	0.63	0.89	1.26	1.79	2.51	3.53	4.97
28	0.47	0.67	0.95	1.34	1.89	2.65	3.73	5.27	

Line offset dimensions shown are Metric (mm) only.

3c

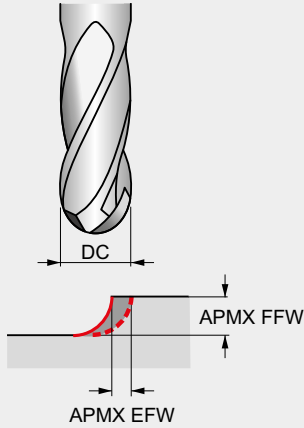

How to use this table to find the correction factor for the feed per tooth (f_z or IPT) for plain copy milling:

1. Find the closest radial immersion (APMX EFW / DC) for your cutting application in the top row of the table.
3. Find your closest axial immersion (APMX FFW / DC) for your cutting application in the left column of the table.
4. The intersection (cell) of the radial and axial immersions is the correction factor for the feed per tooth.

Example for plain copy milling:

1. Applying an 8 mm ball nose cutter with a depth of cut of 0.8 mm (APMX FFW), the aim is to achieve a theoretical surface roughness of 32 μm .
2. The correction factor for cutting speed with an axial immersion of 10% = 1.67 can be found in table 3a.
3. The step-over distance for a R_{th} of 32 μm = 1.01 mm can be found in table 3b.
4. The correction factor for feed per tooth with an axial immersion of 10% and a radial immersion of 1.01 / 8 = 12.6% can be found in table 3c and is in this case 2.33.

Correction factors for feed per tooth f_z for plain copy milling with a line offset < 50% × DC at different of depths of cut.

APMX FFW	APMX EFW	5%	10%	15%	20%	25%	30%	35%	40%	50%
5%	$\times f$ 	5.26	3.82	3.21	2.87	2.65	2.50	2.40	2.34	2.29
10%		3.82	2.78	2.33	2.08	1.92	1.82	1.75	1.70	1.67
15%		3.21	2.33	1.96	1.75	1.62	1.53	1.47	1.43	1.40
20%		2.87	2.08	1.75	1.56	1.44	1.36	1.31	1.28	1.25
25%		2.65	1.92	1.62	1.44	1.33	1.26	1.21	1.18	1.15
30%		2.50	1.82	1.53	1.36	1.26	1.19	1.14	1.11	1.09
35%		2.40	1.75	1.47	1.31	1.21	1.14	1.10	1.07	1.05
40%		2.34	1.70	1.43	1.28	1.18	1.11	1.07	1.04	1.02
45%		2.31	1.68	1.41	1.26	1.16	1.10	1.05	1.03	1.01
50%		2.29	1.67	1.40	1.25	1.15	1.09	1.05	1.02	1.00

To increase the surface quality, the tool or surface should be included with a tilt angle of 10° – 15°.



SOLID HSS MILLS – FEED PER TOOTH TABLE

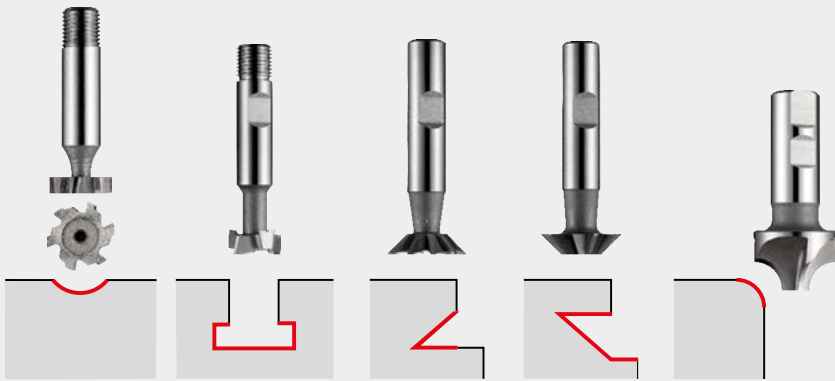

How to use this table to find the feed per tooth (f_z):

1. Find your Alpha Code on the product page (example: 40V, "V" is the Alpha Code).
2. Find the closest diameter for your cutting application in the top row of the table.
3. Find your Alpha Code in the left column of the table.
4. The intersection (cell) of the Diameter and Alpha Code is the feed per tooth (f_z).

Feed per tooth (f_z in mm/rev).

Depended of the working conditions it might be needed to adjust these values $\pm 25\%$.

Feed rates for mills: C800, C801, C810, C820, C822, C825, C830, C835, C837, C831, C700, C710, D745, D747, D750, D751, D752, D753, D200, D763.

		ϕ DC [mm]															
		10.00	12.00	16.00	20.00	25.00	32.00	38.00	50.00	63.00	80.00	100.00	125.00	160.00	200.00	300.00	350.00
Feed rates	P	–	–	–	–	–	0.200	–	0.200	0.200	0.200	0.200	0.200	0.200	0.200	0.200	0.200
	Q	–	–	–	–	–	0.040	–	0.040	0.040	0.040	0.040	0.040	0.040	0.040	0.040	0.040
	R	–	–	–	–	–	0.600	–	0.600	0.600	0.600	0.600	0.600	0.600	0.600	0.600	0.600
	S	0.020	0.020	0.020	0.040	0.040	0.040	0.040	0.050	0.050	0.060	0.070	0.080	0.090	0.100	0.100	0.100
	T	0.020	0.020	0.030	0.050	0.050	0.050	0.060	0.060	0.060	–	–	–	–	–	–	–
	U	0.030	0.030	0.030	0.050	0.060	0.060	0.060	0.060	0.060	–	–	–	–	–	–	–
	V	0.030	0.030	0.040	0.060	0.060	0.060	0.070	0.070	0.070	0.080	0.090	0.100	0.110	0.120	0.120	0.120
	W	0.040	0.050	0.050	0.060	0.060	0.070	0.070	0.070	0.070	0.090	0.100	0.110	0.110	0.120	0.120	0.120
	X	0.050	0.050	0.060	0.070	0.080	0.100	0.110	0.110	0.110	0.110	0.110	0.120	0.130	0.140	0.140	0.140
	Y	0.060	0.060	0.070	0.090	0.100	0.110	0.130	0.130	–	–	–	–	–	–	–	–
Z	0.070	0.070	0.090	0.110	0.120	0.110	0.150	–	–	–	–	–	–	–	–	–	

Feeds (f_z) shown are Metric (mm) only.



SOLID HSS SLITTING SAWS – TOOTH PITCH CHOICE TABLES

Tooth pitch choices for slitting saws D750, D751, D752, D753

		Solid section					
		Saw Pitch (P)					
		2,5	3	4	5	6	8
Diameter (t)	4		P M	N K			
	6			P M N K			
	8				P M N K		
	10				P M N K		
	15					P M N K	
	20					P M N K	
	30						P M
	40						
	60						

		Profiles and Tubes					
		Saw Pitch (P)					
		2,5	3	4	5	6	8
Wall Thickness (t)	1		P M	N K			
	1,5			P M N K			
	2				P M N K		
	3					P M N K	
	> 4						P M N K

- P ISO P = Steel Workpiece Material Group (WMG)
- M ISO M = Stainless Steel Workpiece Material Group (WMG)
- K ISO K = Cast Iron Workpiece Material Group (WMG)
- N ISO N = Non Ferrous Workpiece Material Group (WMG)



DORMER PRAMET



ALL TOOLS TOGETHER

Our entire assortment of rounds tools and indexables is included within the machining calculator app. That's more than 40,000 items! Whatever your machining we're likely to have something for it.
Simply Reliable.

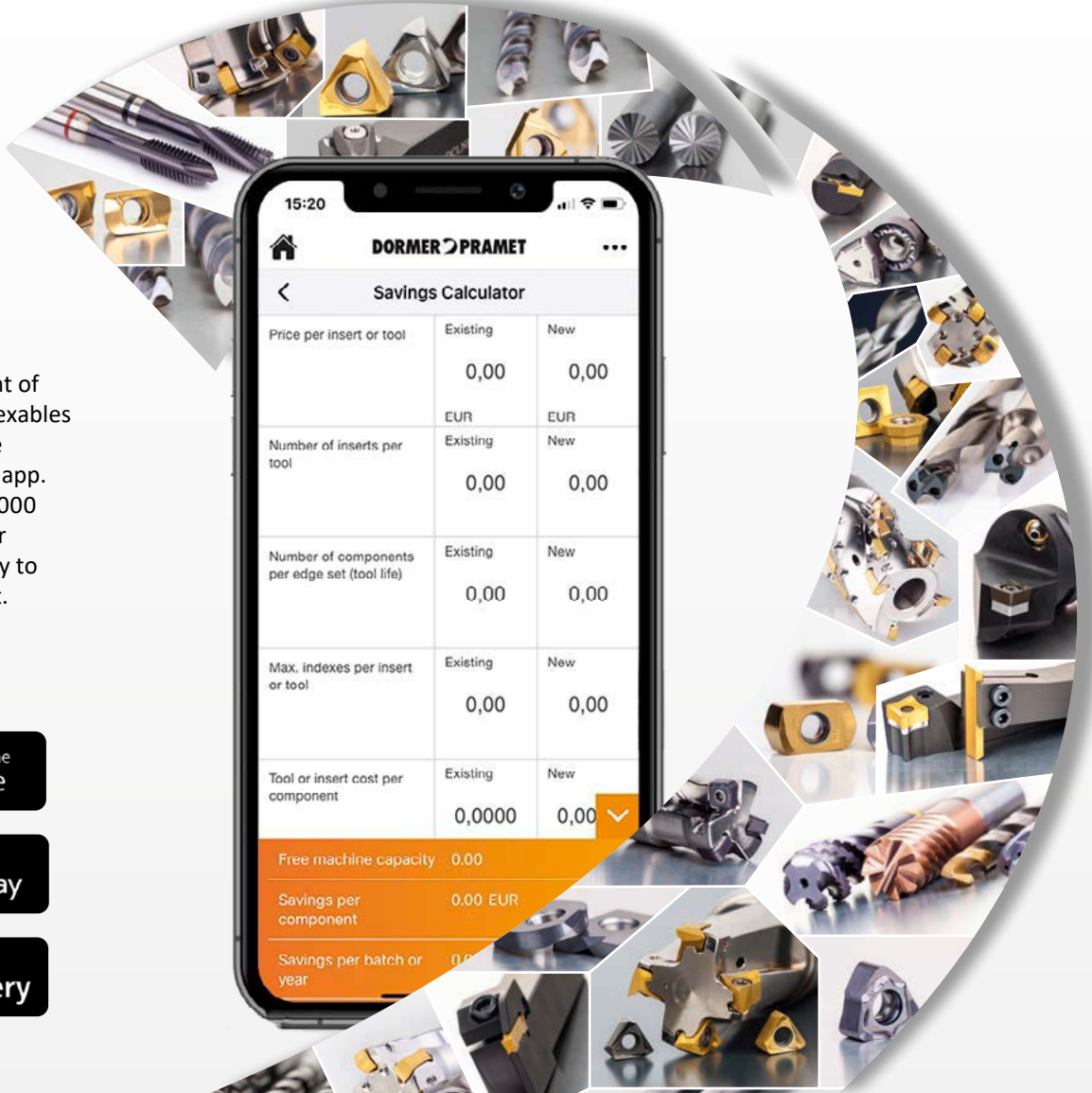

DORMER PRAMET		
Savings Calculator		
Price per insert or tool	Existing 0,00	New 0,00
	EUR	EUR
Number of inserts per tool	Existing 0,00	New 0,00
Number of components per edge set (tool life)	Existing 0,00	New 0,00
Max. indexes per insert or tool	Existing 0,00	New 0,00
Tool or insert cost per component	Existing 0,0000	New 0,00
Free machine capacity	0.00	
Savings per component	0.00 EUR	
Savings per batch or year	0.00	





SOLID MILLS – TECHNICAL INFORMATION



HSS MATERIALS

HSS materials

High Speed Steel	HSS	A medium-alloyed high speed steel that has good machinability and good performance. HSS exhibits hardness, toughness and wear resistance characteristics that make it attractive in a wide range of applications, for example in drills and taps.
Cobalt High Speed Steel	HSS-E	This high speed steel contains cobalt for increased hot hardness. The composition of HSCo is a good combination of toughness and hardness. It has good machinability and good wear resistance, which makes it usable for drills, taps, milling cutters and reamers.
Sintered Cobalt High Speed Steel	HSS-E PM	Sintered Cobalt High Speed Steel (HSCo powder metal) is a substrate produced using powder metallurgy technology. Tools using substrates produced by this method exhibit superior toughness and grindability.

	Grade	Hardness (HV10)	C %	W %	Mo %	Cr %	V %	Co %	Tool Material
HSS	M2	810 – 850	0.9	6.4	5.0	4.2	1.8	–	HSS
HSS-E	M35	830 – 870	0.93	6.4	5.0	4.2	1.8	4.8	HSCo
	M42	870 – 960	1.08	1.5	9.4	3.9	1.2	8.0	
HSS-E PM	ASP 2017	860 – 900	0.8	3.0	3.0	4.0	1.0	8.0	HSCo Powder Metal
	ASP 2030	870 – 910	1.28	6.4	5.0	4.2	3.1	8.5	
	ASP 2052	870 – 910	1.6	10.5	2.0	4.8	5.0	8.0	



HM MATERIALS

HM materials

Carbide Materials (or Hard Materials)

HM

A sintered powder metallurgy substrate, consisting of a metallic carbide composite with binder metal. The most central raw material is tungsten carbide (WC). Tungsten carbide contributes to the hardness of the material. Tantalum carbide (TaC), titanium carbide (TiC) and niobium carbide (NbC) complements WC and adjusts the properties to what is desired. These three materials are called cubic carbides. Cobalt (Co) acts as a binder and keeps the material together.

Carbide materials are often characterised by high compression strength, high hardness and therefore high wear resistance, but also by limited flexural strength and toughness. Carbide is used in taps, reamers, milling cutters, drills and thread milling cutters.

Properties	HSS materials	HM materials	K10/30F (often used for solid tools)
Hardness (HV30)	800 – 950	1300 – 1800	1600
Density (g/cm ³)	8.0 – 9.0	7.2 – 15.0	14.45
Compressive strength (N/mm ²)	3000 – 4000	3000 – 8000	6250
Flexural strength, (bending) (N/mm ²)	2500 – 4000	1000 – 4700	4300
Heat resistance (°C)	550	1000	900
E-module (KN/mm ²)	260 – 300	460 – 630	580
Grain size (µm)	–	0.2 – 10.0	0.8







The combination of hard particle (WC) and binder metal (Co) give the following changes in characteristics.

Characteristic	Higher WC content give	Higher Co content give
Hardness	Higher hardness	Lower hardness
Compressive strength (CS)	Higher CS	Lower CS
Bending strength (BS)	Lower BS	Higher BS

Grain size also influences the material properties. Small grain sizes means higher hardness and coarse grains give more toughness.

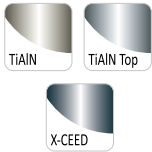

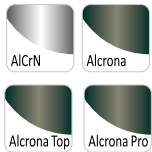



SURFACE TREATMENTS / SURFACE COATINGS

Surface Treatments		
Bright (uncoated)		Bright finish (uncoated surface) improves chip flow in soft or non-ferrous materials and maintains sharp cutting edges in abrasive materials.
Steam Tempering		Steam tempering gives a strongly adhering blue oxide surface that acts to retain cutting fluid and prevent chip to tool welding, thereby counteracting the formation of a built-up edge. Steam tempering can be applied to any bright tool but is most effective on drills and taps.
Surface Coatings		
Titanium Carbon Nitride Coating (TiCN)		Titanium Carbon Nitride is a ceramic coating applied by PVD coating technology. TiCN is harder than TiN and has a lower coefficient of friction. Its hardness and toughness in combination with good wear resistance ensures that it finds its principal application in the field of milling to enhance the performance of milling cutters.
Titanium Aluminium Nitride Coatings (TiAlN, TiAlN-Top & X-CEED)		Titanium Aluminium Nitride is a multi layer ceramic coating applied by PVD coating technology, which exhibits high toughness and oxidation stability. These properties make it ideal for higher speeds and feeds, while at the same time improving tool life. TiAlN is used in drilling, tapping, and milling applications and can be suitable for use when machining without coolant. TiAlN-Top coating is the same as TiAlN but with a post-coating process designed to smooth out imperfections, enhance chip flow and reduce built up edge. X-CEED type TiAlN coating, also known as Futura-Nano coating is a nanolayered coating designed for higher hot hardness and higher stress applications.
Aluminium Titanium Nitride Coating (AlTiN)		Aluminium Titanium Nitride (AlTiN) is a nanolayered broad based coating technology which is an upgrade to the conventional TiAlN coatings and can offer superior toughness, high hot hardness and oxidation resistance.
Alcrona Coatings (AlCrN, Alcrona, Alcrona-Top & Alcrona-Pro)		The Alcrona (AlCrN) family of coatings are aluminium chromium nitride coatings mostly used for milling cutters. The two unique properties of these coatings are high hot hardness and high oxidation resistance. When used on tools for machining applications involving heavy mechanical and thermal stresses, these properties translate into superior wear resistance. Multiple levels or specific versions of these coatings are available and specific for various tools and applications.
Titanium Silicon Nitride Coating (TiSiN)		TiSiN is designed for extreme cutting conditions and high speed machining of hard materials. This multi-layered coating has a nano-composite outer layer with Si ₃ N ₄ nano-crystallites in a crystalline TiN matrix and is engineered to protect the cutting edge from heat transfer, oxidation and abrasion. TiSiN coatings can perform well at minimum to zero lubrication conditions.



SURFACE TREATMENTS / SURFACE COATINGS

Surface treatment / Coating properties examples

Surface Treatments	Color	Coating material	Hardness [HV]	Thickness [μm]	Coating structure	Frict. coeff. against steel	Max. appl. temp. [$^{\circ}\text{C}$]
	Dark grey	Fe_3O_4	400	max. 5	Conversion into the surface	–	550
	Blue grey	TiCN	3000	1–4	Multi-layer gradient	0.4	500
	Black grey	TiAlN	3300	3	Nano structured	0.3–0.35	900
	Blue grey	AlCrN	3200	–	Mono-layer	0.35	1100



MILLING TECHNICAL INFO

Nomenclature

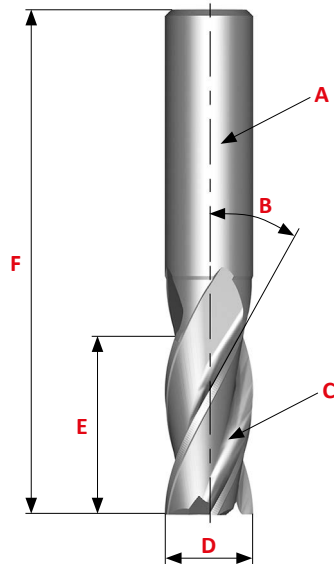

- A** Shank
- B** Helix Angle
- C** Flute
- D** Outside Diameter (DC)
- E** Cutting Length (AP)
- F** Overall Length (OAL)

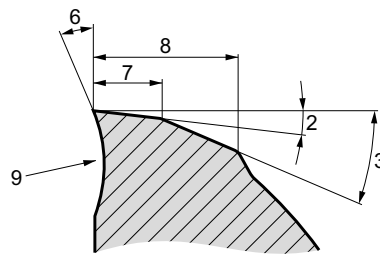
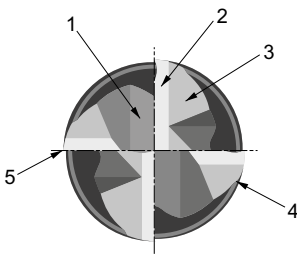

- 1** Gash
- 2** Primary Relief Angle
- 3** Secondary Relief Angle
- 4** Heel
- 5** Cutting Edge
- 6** Rake Angle
- 7** Width of Primary Relief Land
- 8** Width of Secondary Relief Land
- 9** Undercut Face

Features Of The End Mill - Choosing The Number Of Flutes (NOF)

Number of flutes should be determined by:

- Milled material
- Dimension of workpiece
- Milling conditions

	2 Flutes	3 Flutes	4 Flutes (or multi-flutes)
LOW	←————— DEFLECTION STRENGTH —————→		HIGH
BIG	←————— CHIP SPACE —————→		SMALL
	<ul style="list-style-type: none"> • Large chip space. • Easy chip ejection. • Good for slot milling. • Good for heavy duty milling. • Less rigidity due to small section area. • Lower quality surface finish 	<ul style="list-style-type: none"> • Chip space almost as large as for 2 flutes. • Larger section area - higher rigidity than 2 flutes • Improved surface finish 	<ul style="list-style-type: none"> • Highest rigidity. • Largest section area – small chip space. • Gives best surface finish. • Recommended for profiling, side milling and shallow slotting.

Features Of The End Mill – Helix Angle

Increasing the number of flutes makes the load on the single tooth more homogeneous and consequently, this allows for a better finish. But with a high helix angle, the load (FV) along the cutter axis is increased too.

A high FV can give:

- Load problems on the spindle bearings
- Cutter movement along the spindle axis. To avoid this problem it is necessary to use Weldon or better Mechanical or Hydraulical Tool-holder.

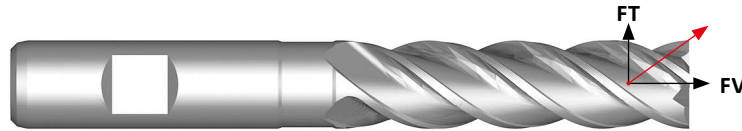

General hints on milling

Milling is a process of generating machined surfaces by progressively removing a predetermined amount of material or stock from the workpiece at a relatively slow rate of movement or feed by a milling cutter rotating at a comparatively high speed. The characteristic feature of the milling process is that each milling cutter tooth removes its share of the stock in the form of small individual chips.

Type of milling cutters

The three basic milling operations are shown below: (A) peripheral milling, (B) face milling and (C) end milling.

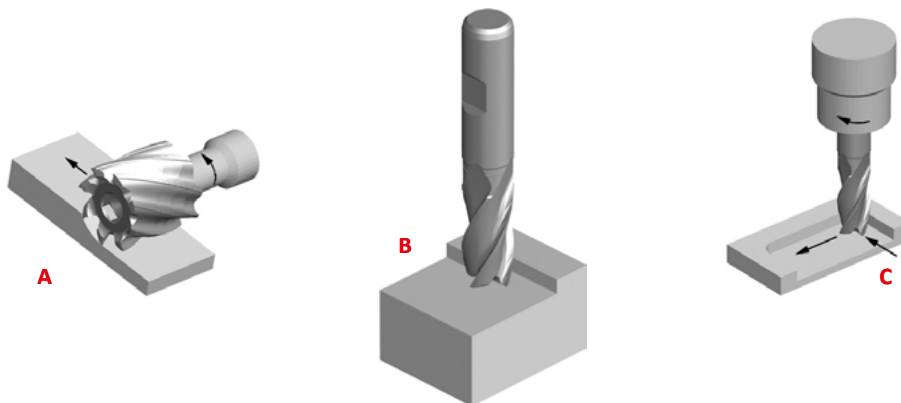

In peripheral milling (also called slab milling), the axis of cutter rotation is parallel to the workpiece surface to be machined. The cutter has a number of teeth along its circumference, each tooth acting like a single-point cutting tool called a plain mill. Cutters used in peripheral milling may have straight or helical teeth generating an orthogonal or oblique cutting action.

In face milling, the cutter is mounted on a spindle with an axis of rotation perpendicular to the workpiece surface. The milled surface results from the action of cutting edges located on the periphery and face of the cutter.

In end milling, the cutter generally rotates on an axis vertical to the workpiece. It can be tilted to machine tapered surfaces. Cutting teeth are located on both the end face of the cutter and the periphery of the cutter body.



MILLING TECHNICAL INFO

Different applications for end mills

The Metal Removal Rate (MRR) and the applications are strongly related. For each different application we have a different MRR that increases with the engagement section of the cutter on the workpiece.

The recent Dormer catalogue was produced with simple icons that show the different applications.

Side Milling	Face Milling	Slot Milling	Plunge Milling	Ramping
The radial depth of cut should be less than 0.25 of the diameter of the end mill.	The radial depth of cut should be no more than 0.9 of the diameter, axial depth of cut less than 0.1 of the diameter.	Machining of a slot for keyways. The radial depth of cut is equal to the diameter on the end mill.	It is possible to drill the workpiece with an end mill only with the cutting centre. In this operation the feed has to be halved.	Both axial and radial entering into the workpiece.

Milling Effectively

Types Of Cuts

Climb Milling Versus Conventional Milling

CLIMB MILLING	CONVENTIONAL MILLING
<p>Chip formed max. thickness</p> <p>Rotation</p> <p>Feed</p>	<p>Chip started zero thickness</p> <p>Rotation</p> <p>Feed</p>
<p>In climb milling, the cutter revolves in the same direction as the table feed. The tooth meets the work at the top of the cut, producing the thickest part of the chip first. In horizontal applications the resultant force created by climb milling can act as a clamping force, acting towards the machine table.</p> <p>It is important to make sure that the machine tool has no leadscrew backlash. Normally climb milling improves product surface finish and increases tool life.</p>	<p>In conventional milling, the cutter revolves opposite to the direction of table feed. Therefore the width of the chip starts at zero and increases to a maximum at the end of the cut. This can lead to accelerated tool wear under some conditions. Conventional milling may be advantageous when milling hot rolled steel, surface hardened and steels with a surface scale.</p>

PERIPHERAL (CYLINDRICAL, SLAB) MILLING

Peripheral Milling The milling of a surface which is parallel to the end mill axis.

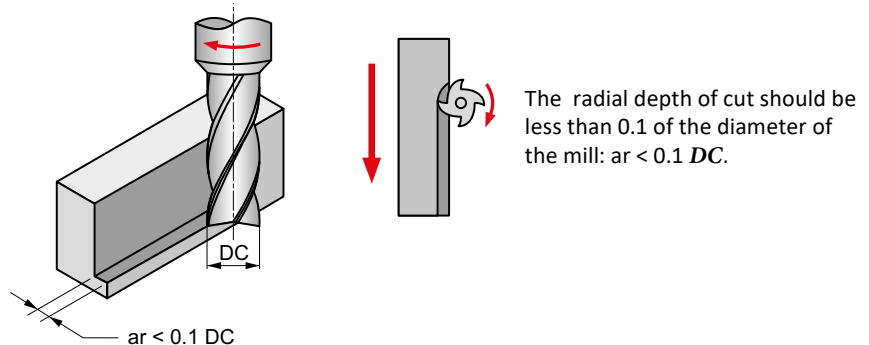



MILLING TECHNICAL INFO

Plunge Milling The direct movement between the workpiece and the centre line of the end mill when the end mill sinks directly into the workpiece.

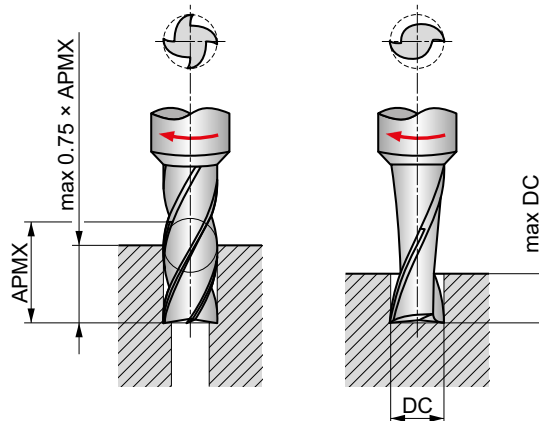

In order to be able to “drill,” i.e. mill with axial feed, an end mill must have an end face cutting edge that goes all the way to the centre. An example of such a solid drilling operation is keyway milling in the middle of a shaft.

In boring, the depth of a hole may be up to 75 % of the cutting edge length. In solid drilling, however, it should not exceed 0.5 – 1.0 *DC*.

Slot Milling

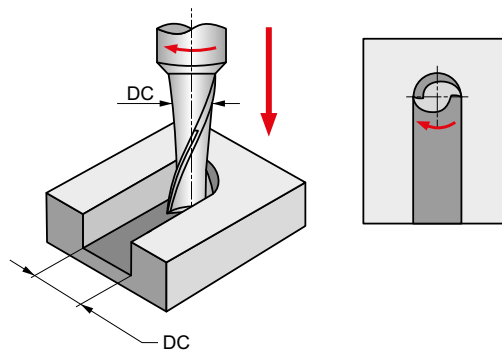

The radial depth of cut is equal to the diameter of the mill: $a_r = DC$.

All slotting applications are a combination of conventional and climb milling. Refer to adjacent section.

End Mill Selection

Utilize the shortest possible tool available for the application with the largest diameter permissible and the shortest flute length as depth of cut allows. Extra length end mills have excessive overhang, thus a reduction in feed up to 25 % may be required. Stub length end mills, due to their short overall and flute length, have more rigidity, thus an increase in feed rates of up to 25 % may be required.

Speeds

Solid Carbide end mills must be run at higher speeds than High Speed Steel end mills. Many times, lighter cuts at higher speeds can improve the finish of the workpiece.

When the application is a slotting cut, the speed should be reduced by approximately 20 %. Speeds should be decreased when milling hard or tough materials or when taking heavy cuts. Speeds should be increased when milling softer materials or when taking lighter cuts. Speeds should also be increased for finishing cuts.

Coolants

Coolants are recommended when milling mild steel and high temperature alloys. The purpose of the coolant media is to direct the chips away from the cutting tool and workpiece. This prevents damage to the cutting edges due to recutting the chips. When machining titanium, coolant flow must be heavy and directed at the area of cut to prevent overheating and assist in chip removal.



OPERATING FORMULAS

Milling Terminology/Operating Formulas

The following terms and formulas can be used to determine the appropriate operating parameters.

Formulas (Metric)			Terms	Formulas (Imperial)		
$V_c = \frac{n \times DC \times \pi}{1000}$	v_c	[m/min]	Cutting speed	<i>SFM</i>	[ft/min]	$SFM = \frac{RPM \times DC \times \pi}{12}$
	n	[rev/min]	Spindle speed	<i>RPM</i>	[rev/min]	
$n = \frac{v_c \times 1000}{DC \times \pi}$	V_f	[mm/min]	Feed rate	<i>IPM</i>	[in/min]	$RPM = \frac{SFM \times 12}{DC \times \pi}$
	f_z	[mm/z]	Feed per tooth	<i>IPT</i>	[in/T]	
$V_f = f_z \times z \times n$	DC	[mm]	Cutting diameter	<i>DC</i>	[in]	$IPM = IPT \times T \times RPM$
$f_z = \frac{V_f}{z \times n}$	z	[-]	Number of teeth	<i>T</i>	[-]	$IPT = \frac{IPM}{T \times RPM}$
$Q = \frac{V_f \times APMX FFW \times APMX EFW}{1000}$	<i>APMX FFW</i>	[mm]	Depth of cut	<i>DOC</i>	[in]	$MRR = IPM \times DOC \times WOC$
	<i>APMX EFW</i>	[mm]	Width of cut	<i>WOC</i>	[in]	
	Q	[cm ³ /min]	Metal removal rate	<i>MRR</i>	in ³ /min	



TROUBLESHOOTING

Problem	Solution
Chipping of the Cutting Edge	<ul style="list-style-type: none"> • Try air blow or coolant • Reduce depth of cut • Check amount of wear on collet • Reduce feed per tooth • If wet cutting, change to dry cutting <ul style="list-style-type: none"> • Check tool runout • Improve the stability of the work-holding
Extreme Flank Wear	<ul style="list-style-type: none"> • Use coated end mill • If conventional milling, change to climb • If using water soluble cutting fluid, change to non-water soluble cutting fluid • Use a tool with a larger helix angle <ul style="list-style-type: none"> • If conventional milling, change to climb
Vibration/Chattering	<ul style="list-style-type: none"> • Use larger diameter end mill • Increase feed per tooth • Increase helix angle • Reduce length of flutes or overhang • Reduce cutting speed <ul style="list-style-type: none"> • Check or change the holder • Increase number of flutes • Tighten chuck or use stronger chuck
Deflection	<ul style="list-style-type: none"> • Reduce depth of cut • Increase feed per tooth • Increase helix angle • If using water soluble cutting fluid, change to non-water soluble cutting fluid <ul style="list-style-type: none"> • Use larger diameter end mill • Reduce length of flutes or overhang • If using 2-flute type, change to 4-flute type • If climb milling, change to conventional milling
Poor Surface Finish	<ul style="list-style-type: none"> • Reduce end mill runout • Increase cutting speed • Reduce feed per tooth • Increase helix angle • Increase number of flutes <ul style="list-style-type: none"> • Increase volume of air or cutting fluid • Reduce depth of cut • If dry cutting, change to wet cutting
Waviness	<ul style="list-style-type: none"> • Reduce helix angle • Check end mill runout • Reduce depth of cut • Check or change the holder
End Mill Fracturing	<ul style="list-style-type: none"> • Reduce depth of cut • Reduce feed per tooth • Reduce length of flutes or overhang • If chip jamming occurs, reduce the number of flutes
Poor Chip Disposal	<ul style="list-style-type: none"> • Use air blow • Reduce depth of cut • Reduce feed per tooth • Reduce the number of flutes • Increase volume of air or cutting fluid <ul style="list-style-type: none"> • Increase cutting speed
Burring Workpiece Chipping	<ul style="list-style-type: none"> • Reduce helix angle • Reduce feed per tooth • Reduce depth of cut
Chip Welding	<ul style="list-style-type: none"> • Use coolant • Use coated end mill • Increase volume of cutting fluid • Increase helix angle

ROTARY BURRS





MILLING – GENERAL CONTENT

6	SOLID MILLS	WMG & ISO 13399
10		INSTRUCTIONS
19		HM MILLS
117		HSS-E-PM, HSS-E, HSS MILLS
201		TECHNICAL INFORMATION
212		ROTARY BURRS
292		THREAD MILLS
314	INDEXABLE MILLS	INSTRUCTIONS
328		NAVIGATORS
349		FACE MILLS
409		SQUARE SHOULDER MILLS
479		DEEP SHOULDER MILLS
508		SLOT MILLS
521		COPY MILLS
613		HIGH FEED MILLS (HFC)
645		CHAMFER & T-SLOT MILLS
667		OTHER INSERTS
691		TECHNICAL INFORMATION



CARBIDE ROTARY BURRS

Our range of carbide rotary burrs is a high quality and comprehensive program. This includes a variety of designs and shapes to offer an ideal option for the majority of applications in all major industry segments.

FEATURES AND BENEFITS

- The combination of premium grade materials for both the shank and head, with the precise production process, results in the creation of a consistent and secure program of tools.
- Each CUT STYLE has been designed to be the first choice for high performance machining in the relevant material. This includes steels (ST CUT), stainless

steels (VA CUT), non-ferrous materials and plastics (ALUMINIUM CUT), superalloys (AS CUT), fibreglass and composite materials (GRP CUT), and general machining (DC CUT).

SHANK

- Toughened and hardened steel shanks
- Provides rigidity and strength
- Prevents bending and reduces vibration, resulting in improved tool life
- Ground to h6 (carbide) and h7 (steel) for improved holding

BRAZING

- Special brazing elements provide excellent braze strength
- Excellent impact strength to withstand high forces
- Able to withstand higher temperature without failing

CUT STYLES



ST

ST CUT

First choice for high performance machining of **Steels**

- Material specific chip breaker design for higher machining output on steel parts
- Positive geometry, ensures smooth surface finish
- Creates less temperature which helps increase tool life



VA

VA CUT

First choice for high performance machining of **Stainless steels**

- Sharp cutting geometry, reducing the onset of work-hardening
- Increases metal removal rate



AL

ALUMINIUM CUT

First choice for **Non ferrous materials and Plastics**

- High helix and large flute volume for rapid metal removal



CARBIDE ROTARY BURRS



BALL NOSE GEOMETRY

- Skip flute grinding
- Increased strength at the centre
- Reduced chance of swarf congestion
- Improved cutting action closer to the centre



Skip

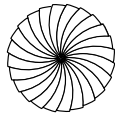

Normal

TiAlN COATING

- Increased tool life in difficult conditions
- Reduced friction improves swarf evacuation
- Helps resist “built-up edge” common with cutting tools with small flute volumes



AS

AS CUT

First choice for **Superalloys**

- Ergonomic
- High quality surface finish
- Fast and smooth cutting action



GRP

GRP CUT

First choice for **Fibreglass and Composite materials**

- Available with Drill Point and End Mill styles
- Designed to reduce splintering and improve entry and exit surface quality



DC

DOUBLE CUT

First choice for **General machining**

- Improves ease of control
- Increases metal removal rate



CARBIDE ROTARY BURRS

FOR BOLT REMOVAL

A specially designed range of burrs to prepare the surface of broken bolts to improve drill location and prevent damaging the threaded hole and component.

FEATURES AND BENEFITS

- Specific diameters and cutting lengths to suit various thread diameters
- Long reach and tapered shanks for easy access
- Developed cutting geometry for machining high tensile materials
- Reduces potential damage to existing threaded holes
- Improves drill location, ensuring damaged bolt is drilled on centre
- Prevents potential scrappage of component
- Highly consistent quality

OPERATIONS

CUT STYLES

①

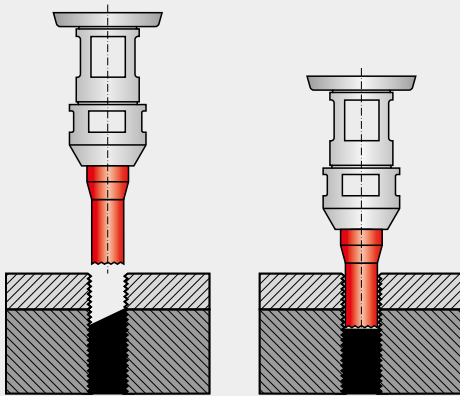

PLAIN CYLINDER
WITH END CUT



②

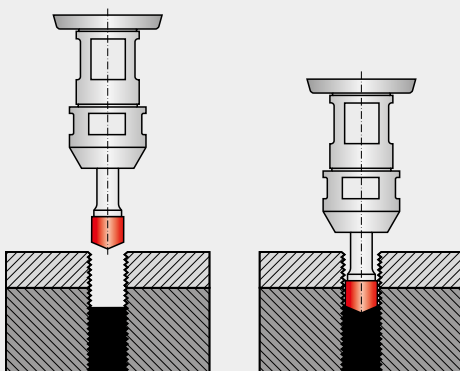

150° COUNTERSINK



HOW TO USE THE TOOLS

- Choose the correct size burr for the broken bolt
- Use a right-handed die grinder
- Ensure the burr is perpendicular to the broken bolt
- Grind the broken surface flat – Operation ①
- Grind into the prepared surface to form a countersink location at the centre point of the bolt – Operation ②



POCKET SAVER

Our machining calculator allows you to measure the savings based on different products and applications. A useful pocket-sized tool, which will help keep cash in your pockets! **Simply Reliable.**

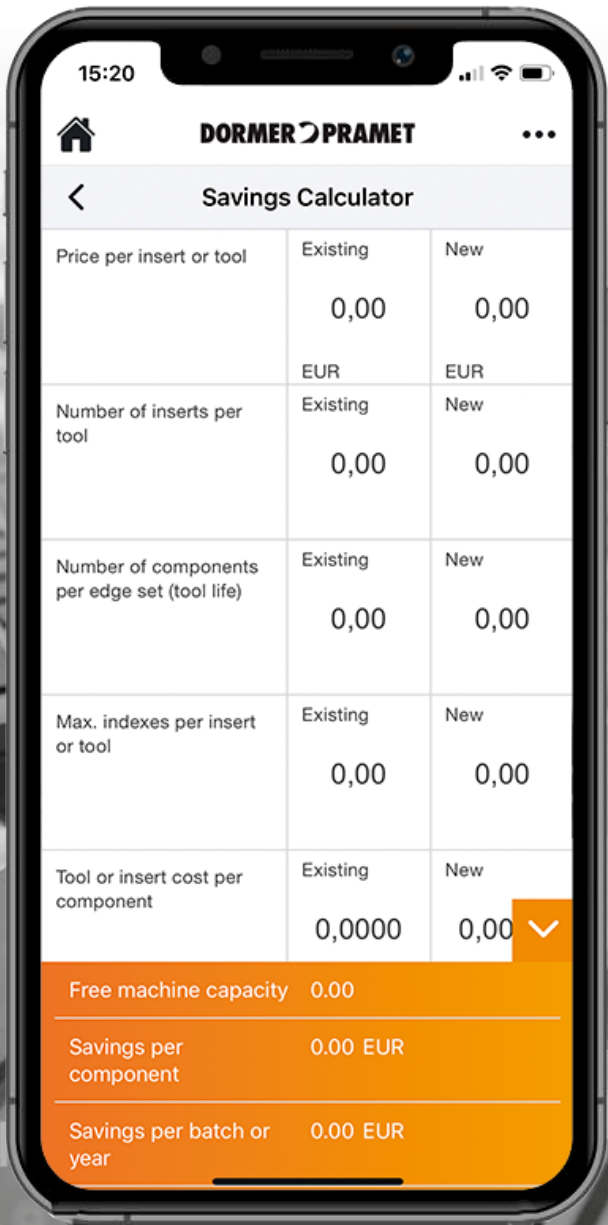



1 P811



2 Rotary Burr - Ball Nosed Tree, Shape F, Bright Finish

DC double cut flute style with close spaced edges for multi-angle contouring, rounding of edges and cutting into hard to reach areas. Carbide design for cutting diameter up to 6 mm; above 6 mm carbide head with toughened and hardened steel shank.

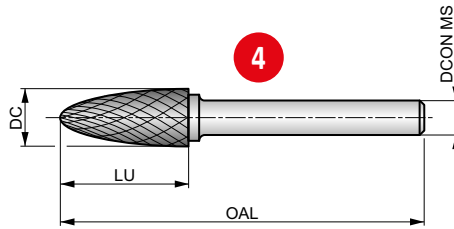

HM	F Bright	Bright
DC	5 DORMER	

				6
--	--	--	--	----------

Workpiece material group suitability. Recommended operating speed (RPM) on page 229.

P1.1	P1.2	P1.3	P2.1	P2.2	P2.3	P3.1	P3.2	P3.3	P4.1	P4.2	P4.3	M1.1	M1.2
M2.1	M2.2	M2.3	M3.1	M3.2	M3.3	M4.1	M4.2	K1.1	K1.2	K1.3	K2.1	K2.2	K2.3
K3.1	K3.2	K3.3	K4.1	K4.2	K4.3	K4.4	K4.5	K5.1	K5.2	K5.3	N3.1	N3.2	N3.3
S1.1	S1.2	S1.3	S2.1	S2.2	S3.1	S3.2	S4.1	S4.2	H1.1	H2.1	H2.2	H3.1	H3.2
H4.1	H4.2												

DC≤6.00 mm: DCON MS tolerance h6; DC>6.00 mm: Brazed on steel shank with DCON MS tolerance h7.
Products from this series are also available in set. Please see P880 or P890.

8 t	DC	DCON MS	9	LU	OAL
	(mm)	(mm)		(mm)	(mm)
P8113.0X3.0	3.00	3.00		14.00	38.0
P8116.3X3.0	6.30	3.00		12.70	45.0
P8116.0X6.0	6.00	6.00		18.00	50.0
P8118.0X6.0	8.00	6.00		20.00	65.0
P8119.6X6.0	9.60	6.00		19.00	64.0
P81112.7X6.0	12.70	6.00		25.00	70.0
P81116.0X6.0	16.00	6.00		25.00	70.0



ROTARY BURRS – PAGE OVERVIEW

Pos.	Description	Pos.	Description
1	Designation of rotary burrs	6	Deburring operations
2	Product description	7	Material group recommendations
3	Illustrative picture	8	Product code
4	Schematic drawing of tool	9	Product dimensions
5	Product features		



ROTARY BURRS – ICONS OVERVIEW

General Icons

	Primary use
	Possible use

Material Code (BMC)

HM	Hard Material (Solid Carbide)
-----------	-------------------------------

Burr Shape

A	Cylinder Shape without endcut	F	Ball Nosed Tree Shape	L	Ball Nosed Cone Shape
B	Cylinder Shape with endcut	G	Pointed Tree Shape	M	Cone Shape
C	Ball Nosed Cylinder Shape	H	Flame Shape	N	Inverted Cone Shape
D	Ball Shape	J	60° Countersink Shape		
E	Oval Shape	K	90° Countersink Shape		

Burr End Shot

	Drill Point Burr End
	End Cut Burr End
	End Mill Burr End

Coating

	Bright (uncoated)
	Titanium Aluminium Nitride Coating



ROTARY BURRS – ICONS OVERVIEW

Application Angle

	60° Countersink
	90° Countersink

	Drill Point 135°
	Drill Point 180°

	Spot Drill Point 150°
---	-----------------------

Burr Cut Flute Style (BTC)

DC	Double Cut Geometry
ST	Steel Cut Geometry
VA	Stainless Steel Cut Geometry





AL	Aluminium Cut Geometry
GRP	Fibreglass and Composite Materials Cut Geometry
BR	Bolt Removal Cut Geometry





AS	Superalloy Cut Geometry
-----------	-------------------------

Basic Standard Group (BSG)

	Dormer Standards
--	------------------

Operations Deburring

	Deburring - Bolt removal operation 1
	Deburring - Bolt removal operation 2
	Closed groove deburring and carving
	Composite fibre routing

	Curved surface deburring and carving
	Fillet radii deburring
	Free hand deburring and carving
	Chamfer deburring

	Inverted back deburring
	Plain surface deburring
	Shoulder deburring
	V-groove deburring

Other Icons

	Bolt size
---	-----------



ROTARY BURRS – TOOL MATERIALS NAVIGATOR

HM materials

Carbide Materials (or Hard Materials)

HM

A sintered powder metallurgy substrate, consisting of a metallic carbide composite with binder metal. The most central raw material is tungsten carbide (WC). Tungsten carbide contributes to the hardness of the material. Tantalum carbide (TaC), titanium carbide (TiC) and niobium carbide (NbC) complements WC and adjusts the properties to what is desired. These three materials are called cubic carbides. Cobalt (Co) acts as a binder and keeps the material together.

Carbide materials are often characterised by high compression strength, high hardness and therefore high wear resistance, but also by limited flexural strength and toughness. Carbide is used in taps, reamers, milling cutters, drills and thread milling cutters.



ROTARY BURRS – SURFACE AND TREATMENTS COATINGS NAVIGATOR

Surface Treatments

Bright (uncoated)	 Bright	Bright finish (uncoated surface) improves chip flow in soft or non-ferrous materials and maintains sharp cutting edges in abrasive materials.
--------------------------	--	---

Surface Coatings

Titanium Aluminium Nitride Coating (TiAlN)	 TiAlN	Titanium Aluminium Nitride is a multi layer ceramic coating applied by PVD coating technology, which exhibits high toughness and oxidation stability. These properties make it ideal for higher speeds and feeds, while at the same time improving tool life. TiAlN is used in drilling, tapping, and milling applications and can be suitable for use when machining without coolant.
---	---	--



Material code (BMC)	HM	HM	HM	HM	HM	HM	HM	HM	HM	HM	HM	HM	HM	
	Burr Shape	A	A	B	B	C	C	D	D	E	F	F	G	G
Burr end shot														
	Coating	Bright	TiAlN	Bright	TiAlN	Bright	TiAlN	Bright	TiAlN	Bright	Bright	TiAlN	Bright	TiAlN
Application angle														
	Burr Type Code (BTC)	DC	DC	DC	DC	DC	DC	DC	DC	DC	DC	DC	DC	DC
Basic standard group (BSG)														
	Product Family Code													
		P801	P801C	P803	P803C	P805	P805C	P807	P807C	P809	P811	P811C	P813	P813C
		3.00 - 16.00	3.00 - 12.70	3.00 - 16.00	3.00 - 12.70	3.00 - 16.00	3.00 - 12.70	3.00 - 16.00	3.00 - 12.70	3.00 - 16.00	3.00 - 16.00	3.00 - 12.70	3.00 - 16.00	3.00 - 12.70
P	P1	■	■	■	■	■	■	■	■	■	■	■	■	
	P2	■	■	■	■	■	■	■	■	■	■	■	■	
	P3	■	■	■	■	■	■	■	■	■	■	■	■	
	P4	■	■	■	■	■	■	■	■	■	■	■	■	
M	M1	■	■	■	■	■	■	■	■	■	■	■	■	
	M2	■	■	■	■	■	■	■	■	■	■	■	■	
	M3	■	■	■	■	■	■	■	■	■	■	■	■	
	M4	■	■	■	■	■	■	■	■	■	■	■	■	
K	K1	■	■	■	■	■	■	■	■	■	■	■	■	
	K2	■	■	■	■	■	■	■	■	■	■	■	■	
	K3	■	■	■	■	■	■	■	■	■	■	■	■	
	K4	■	■	■	■	■	■	■	■	■	■	■	■	
	K5	■	■	■	■	■	■	■	■	■	■	■	■	
N	N1													
	N2													
	N3	■	■	■	■	■	■	■	■	■	■	■	■	
	N4													
	N5													
S	S1	■	■	■	■	■	■	■	■	■	■	■	■	
	S2	■	■	■	■	■	■	■	■	■	■	■	■	
	S3	■	■	■	■	■	■	■	■	■	■	■	■	
	S4	■	■	■	■	■	■	■	■	■	■	■	■	
H	H1	■	■	■	■	■	■	■	■	■	■	■	■	
	H2	■	■	■	■	■	■	■	■	■	■	■	■	
	H3	■	■	■	■	■	■	■	■	■	■	■	■	
	H4	■	■	■	■	■	■	■	■	■	■	■	■	

■ Primary use ▣ Possible use



	HM	HM	HM	HM	HM	HM	HM	HM	HM	HM	HM	HM	HM	HM	
	H	H	J	K	L	L	M	N	A	B	C	D	E	F	G
	Bright	TIAlN	Bright	Bright	Bright	TIAlN	Bright	Bright	Bright	Bright	Bright	Bright	Bright	Bright	Bright
			60°	90°											
	DC	DC	DC	DC	DC	DC	DC	DC	ST	ST	ST	ST	ST	ST	ST
	DORMER	DORMER	DORMER	DORMER	DORMER	DORMER	DORMER	DORMER	DORMER	DORMER	DORMER	DORMER	DORMER	DORMER	DORMER
	P815	P815C	P817	P819	P821	P821C	P823	P825	P701	P703	P705	P707	P709	P711	P713
	3.00 - 16.00	8.00 - 12.70	3.00 - 16.00	3.00 - 16.00	3.00 - 16.00	3.00 - 12.70	3.00 - 16.00	3.00 - 16.00	6.00 - 12.70	6.00 - 12.70	6.00 - 12.70	6.00 - 12.70	12.70	6.00 - 12.70	6.00 - 12.70
	243	244	245	246	247	248	249	250	251	252	253	254	255	256	257
P1	■	■	■	■	■	■	■	■	■	■	■	■	■	■	■
P2	■	■	■	■	■	■	■	■	■	■	■	■	■	■	■
P3	■	■	■	■	■	■	■	■	■	■	■	■	■	■	■
P4	■	■	■	■	■	■	■	■	■	■	■	■	■	■	■
M1	■	■	■	■	■	■	■	■							
M2	■	■	■	■	■	■	■	■							
M3	■	■	■	■	■	■	■	■							
M4	■	■	■	■	■	■	■	■							
K1	■	■	■	■	■	■	■	■							
K2	■	■	■	■	■	■	■	■							
K3	■	■	■	■	■	■	■	■							
K4	■	■	■	■	■	■	■	■							
K5	■	■	■	■	■	■	■	■							
N1															
N2															
N3	■	■	■	■	■	■	■	■							
N4															
N5															
S1	■	■	■	■	■	■	■	■							
S2	■	■	■	■	■	■	■	■							
S3	■	■	■	■	■	■	■	■							
S4	■	■	■	■	■	■	■	■							
H1	■	■	■	■	■	■	■	■							
H2	■	■	■	■	■	■	■	■							
H3	■	■	■	■	■	■	■	■							
H4	■	■	■	■	■	■	■	■							



Material code (BMC)	HM	HM	HM	HM	HM	HM	HM	HM	HM	HM	HM	HM	HM
	Burr Shape	H	L	A	C	D	E	F	G	H	L	A	B
Burr end shot													
Coating	Bright	Bright	Bright	Bright	Bright	Bright	Bright	Bright	Bright	Bright	Bright	Bright	Bright
Application angle													
Burr Type Code (BTC)	ST	ST	VA	VA	VA	VA	VA	VA	VA	VA	AL	AL	AL
Basic standard group (BSG)	DORMER	DORMER	DORMER	DORMER	DORMER	DORMER	DORMER	DORMER	DORMER	DORMER	DORMER	DORMER	DORMER
Product Family Code													
	P715	P721	P601	P605	P607	P609	P611	P613	P615	P621	P831	P833	P835
	8.00 - 12.70	10.00 - 12.70	3.00 - 12.70	3.00 - 12.70	3.00 - 12.70	8.00 - 12.70	3.00 - 12.70	6.00 - 12.70	8.00 - 12.70	8.00 - 12.70	6.00 - 12.70	6.00 - 12.70	6.00 - 12.70
258	259	260	261	262	263	264	265	266	267	268	269	270	
P	P1	■	■										
	P2	■	■										
	P3	■	■										
	P4	■	■										
M	M1		■	■	■	■	■	■	■	■			
	M2		■	■	■	■	■	■	■	■			
	M3		■	■	■	■	■	■	■	■			
	M4		■	■	■	■	■	■	■	■			
K	K1								▣				
	K2												
	K3												
	K4			▣	▣	▣	▣	▣	▣	▣			
	K5												
N	N1										■	■	■
	N2										■	■	■
	N3										▣	▣	▣
	N4										■	■	■
	N5												
S	S1										▣	▣	▣
	S2												
	S3												
	S4												
H	H1												
	H2												
	H3												
	H4												

■ Primary use ▣ Possible use



	HM	HM	HM	HM	HM	HM	HM	HM	HM	HM	HM	HM	HM	HM	HM	
	Bright	Bright	Bright	Bright	Bright	Bright	Bright	Bright	Bright	Bright	Bright	Bright	Bright	Bright	Bright	
	AL	AL	AL	AS	AS	AS	AS	AS	AS	AS	AS	AS	GRP	GRP	BR	
	P837	P841	P842	P501	P505	P507	P509	P511	P513	P515	P521	P523	P843	P844	P100	
	6.00 - 12.70	6.00 - 12.70	6.00 - 12.70	3.00	3.00	3.00	3.00	3.00	3.00	3.00	3.00	3.00	3.00 - 8.00	3.00 - 8.00	4.90 - 10.70	
	271	272	273	274	275	276	277	278	279	280	281	282	283	284	285	
P1																■
P2																■
P3																■
P4																■
M1																■
M2																■
M3				☑	☑	☑	☑	☑	☑	☑	☑	☑				■
M4				☑	☑	☑	☑	☑	☑	☑	☑	☑				■
K1																
K2																
K3																
K4																
K5																
N1	■	■	■													
N2	■	■	■													
N3	☑	☑	☑													
N4	■	■	■										■	■		
N5																
S1	☑	☑	☑	■	■	■	■	■	■	■	■	■				
S2				■	■	■	■	■	■	■	■	■				
S3				■	■	■	■	■	■	■	■	■				
S4				■	■	■	■	■	■	■	■	■				
H1																
H2																
H3																
H4																



Material code (BMC)	HM																				
Burr Shape																					
Burr end shot																					
Coating	Bright																				
Application angle	150°																				
Burr Type Code (BTC)	BR																				
Basic standard group (BSG)	DORMER																				
Product Family Code	P101	P880	P890																		
	4.90 - 10.70	Set	Set																		
	286	287	288																		
P	P1	■																			
	P2	■																			
	P3	■																			
	P4	■																			
M	M1	■																			
	M2	■																			
	M3	■																			
	M4																				
K	K1																				
	K2																				
	K3																				
	K4																				
	K5																				
N	N1																				
	N2																				
	N3																				
	N4																				
	N5																				
S	S1																				
	S2																				
	S3																				
	S4																				
H	H1																				
	H2																				
	H3																				
	H4																				

■ Primary use ▣ Possible use



RECOMMENDED OPERATING SPEED (RPM)

		AL DC						
ISO		RPM						
		DC [mm]						
		3	6	8	10	12	16	20
P	min	64 000	32 000	24 000	20 000	16 000	12 000	10 000
	max	83 000	42 000	32 000	25 000	21 000	16 000	13 000
M	min	45 000	23 000	17 000	14 000	12 000	9 000	7 000
	max	64 000	32 000	24 000	20 000	16 000	12 000	10 000
K	min	58 000	29 000	22 000	19 000	15 000	11 000	9 000
	max	77 000	39 000	29 000	23 000	20 000	15 000	12 000
N	min	64 000	32 000	24 000	20 000	16 000	12 000	10 000
	max	96 000	48 000	36 000	29 000	24 000	18 000	15 000
S	min	45 000	23 000	17 000	14 000	12 000	9 000	7 000
	max	58 000	29 000	22 000	18 000	15 000	11 000	9 000
H	min	51 000	26 000	20 000	16 000	13 000	10 000	8 000
	max	71 000	36 000	27 000	22 000	18 000	14 000	11 000

		ST BR				
ISO		RPM				
		DC [mm]				
		3	6	8	10	12
P	min	100 000	65 000	60 000	55 000	35 000
	max	60 000	45 000	35 000	30 000	20 000

		VA BR				
ISO		RPM				
		DC [mm]				
		3	6	8	10	12
M	min	100 000	65 000	60 000	55 000	35 000
	max	60 000	30 000	25 000	20 000	15 000

		GRP		
ISO		RPM		
		DC [mm]		
		3	6	8
N4	min	25 000	20 000	18 000
	max	30 000	25 000	22 000

		AS	
ISO		RPM	
		DC [mm]	
		3	
S	min	60 000	
	max	80 000	



P801



Rotary Burr - Cylinder without endcut, Shape A, Bright Finish

DC double cut flute style with close spaced edges for trimming and deburring surfaces. Carbide design for cutting diameter up to 6 mm; above 6 mm carbide head with toughened and hardened steel shank.

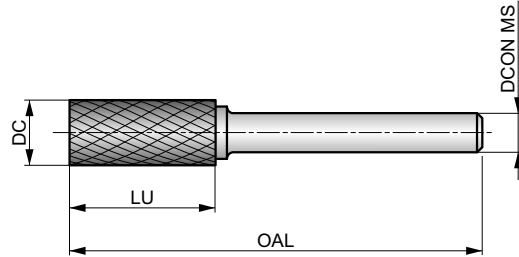

HM	A	Bright
DC		

Workpiece material group suitability. Recommended operating speed (RPM) on page 229.

P1.1	P1.2	P1.3	P2.1	P2.2	P2.3	P3.1	P3.2	P3.3	P4.1	P4.2	P4.3	M1.1	M1.2
M2.1	M2.2	M2.3	M3.1	M3.2	M3.3	M4.1	M4.2	K1.1	K1.2	K1.3	K2.1	K2.2	K2.3
K3.1	K3.2	K3.3	K4.1	K4.2	K4.3	K4.4	K4.5	K5.1	K5.2	K5.3	N3.1	N3.2	N3.3
S1.1	S1.2	S1.3	S2.1	S2.2	S3.1	S3.2	S4.1	S4.2	H1.1	H2.1	H2.2	H3.1	H3.2
H4.1	H4.2												

DC ≤ 6.00 mm: DCON MS tolerance h6; DC > 6.00 mm: Brazed on steel shank with DCON MS tolerance h7.
Products from this series are also available in set. Please see P880.

Product	DC	DCON MS	LU	OAL
	[mm]	[mm]	[mm]	[mm]
P8013.0X3.0	3.00	3.00	14.00	38.0
P8016.3X3.0	6.30	3.00	12.70	45.0
P8016.0X6.0	6.00	6.00	18.00	50.0
P8018.0X6.0	8.00	6.00	19.00	64.0
P8019.6X6.0	9.60	6.00	19.00	64.0
P80112.7X6.0	12.70	6.00	25.00	70.0
P80116.0X6.0	16.00	6.00	25.00	70.0



P801C



Rotary Burr - Cylinder without endcut, Shape A, TiAlN Coating

DC double cut flute style with close spaced edges for trimming and deburring surfaces. Carbide design for cutting diameter up to 6 mm; above 6 mm carbide head with toughened and hardened steel shank. TiAlN coating for increased tool life, reduced friction and improved swarf evacuation.

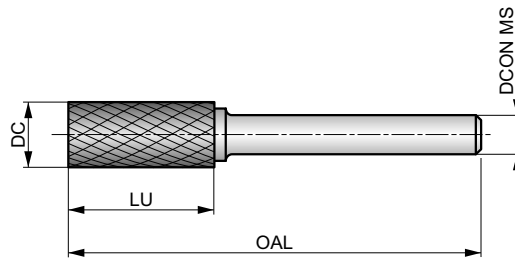

HM	A	TiAlN
DC	DORMER	



Workpiece material group suitability. Recommended operating speed (RPM) on page 229.

P1.1	P1.2	P1.3	P2.1	P2.2	P2.3	P3.1	P3.2	P3.3	P4.1	P4.2	P4.3	M1.1	M1.2
M2.1	M2.2	M2.3	M3.1	M3.2	M3.3	M4.1	M4.2	K1.1	K1.2	K1.3	K2.1	K2.2	K2.3
K3.1	K3.2	K3.3	K4.1	K4.2	K4.3	K4.4	K4.5	K5.1	K5.2	K5.3	N3.1	N3.2	N3.3
S1.1	S1.2	S1.3	S2.1	S2.2	S3.1	S3.2	S4.1	S4.2	H1.1	H2.1	H2.2	H3.1	H3.2
H4.1	H4.2												

DC ≤ 6.00 mm: DCON MS tolerance h6; DC > 6.00 mm: Brazed on steel shank with DCON MS tolerance h7.

Product	DC [mm]	DCON MS [mm]	LU [mm]	OAL [mm]
P801C3.0X3.0	3.00	3.00	14.00	38.0
P801C6.0X6.0	6.00	6.00	18.00	50.0
P801C8.0X6.0	8.00	6.00	19.00	64.0
P801C9.6X6.0	9.60	6.00	19.00	64.0
P801C12.7X6.0	12.70	6.00	25.00	70.0



P803



Rotary Burr - Cylinder with endcut, Shape B, Bright Finish

DC double cut flute style with close spaced edges for trimming and deburring surfaces and right-angled corners. Carbide design for cutting diameter up to 6 mm; above 6 mm carbide head with toughened and hardened steel shank.

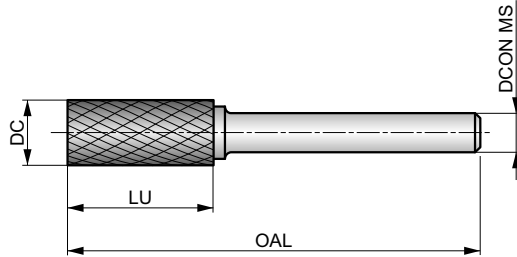

HM	B	
Bright	DC	



Workpiece material group suitability. Recommended operating speed (RPM) on page 229.

P1.1	P1.2	P1.3	P2.1	P2.2	P2.3	P3.1	P3.2	P3.3	P4.1	P4.2	P4.3	M1.1	M1.2
M2.1	M2.2	M2.3	M3.1	M3.2	M3.3	M4.1	M4.2	K1.1	K1.2	K1.3	K2.1	K2.2	K2.3
K3.1	K3.2	K3.3	K4.1	K4.2	K4.3	K4.4	K4.5	K5.1	K5.2	K5.3	N3.1	N3.2	N3.3
S1.1	S1.2	S1.3	S2.1	S2.2	S3.1	S3.2	S4.1	S4.2	H1.1	H2.1	H2.2	H3.1	H3.2
H4.1	H4.2												

DC ≤ 6.00 mm: DCON MS tolerance h6; DC > 6.00 mm: Brazed on steel shank with DCON MS tolerance h7.
Products from this series are also available in set. Please see P880 or P890.

Product	DC [mm]	DCON MS [mm]	LU [mm]	OAL [mm]
P8033.0X3.0	3.00	3.00	14.00	38.0
P8036.3X3.0	6.30	3.00	12.70	45.0
P8036.0X6.0	6.00	6.00	18.00	50.0
P8038.0X6.0	8.00	6.00	19.00	64.0
P8039.6X6.0	9.60	6.00	19.00	64.0
P80312.7X6.0	12.70	6.00	25.00	70.0
P80316.0X6.0	16.00	6.00	25.00	70.0



P803C



Rotary Burr - Cylinder with endcut, Shape B, TiAlN Coating

DC double cut flute style with close spaced edges for trimming and deburring surfaces and right-angled corners. Carbide design for cutting diameter up to 6 mm; above 6 mm carbide head with toughened and hardened steel shank. TiAlN coating for increased tool life, reduced friction and improved swarf evacuation.

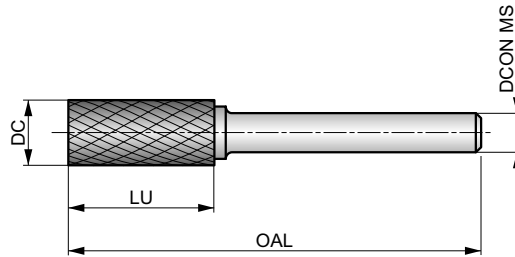

Workpiece material group suitability. Recommended operating speed (RPM) on page 229.

P1.1	P1.2	P1.3	P2.1	P2.2	P2.3	P3.1	P3.2	P3.3	P4.1	P4.2	P4.3	M1.1	M1.2
M2.1	M2.2	M2.3	M3.1	M3.2	M3.3	M4.1	M4.2	K1.1	K1.2	K1.3	K2.1	K2.2	K2.3
K3.1	K3.2	K3.3	K4.1	K4.2	K4.3	K4.4	K4.5	K5.1	K5.2	K5.3	N3.1	N3.2	N3.3
S1.1	S1.2	S1.3	S2.1	S2.2	S3.1	S3.2	S4.1	S4.2	H1.1	H2.1	H2.2	H3.1	H3.2
H4.1	H4.2												

DC ≤ 6.00 mm: DCON MS tolerance h6; DC > 6.00 mm: Brazed on steel shank with DCON MS tolerance h7.
 Products from this series are also available in set. Please see P880.

Product	DC [mm]	DCON MS [mm]	LU [mm]	OAL [mm]
P803C3.0X3.0	3.00	3.00	14.00	38.0
P803C6.0X6.0	6.00	6.00	18.00	50.0
P803C8.0X6.0	8.00	6.00	19.00	64.0
P803C9.6X6.0	9.60	6.00	19.00	64.0
P803C12.7X6.0	12.70	6.00	25.00	70.0



P805



Rotary Burr - Ball Nosed Cylinder, Shape C, Bright Finish

DC double cut flute style with close spaced edges for trimming and deburring contours and circular arcs. Carbide design for cutting diameter up to 6 mm; above 6 mm carbide head with toughened and hardened steel shank.

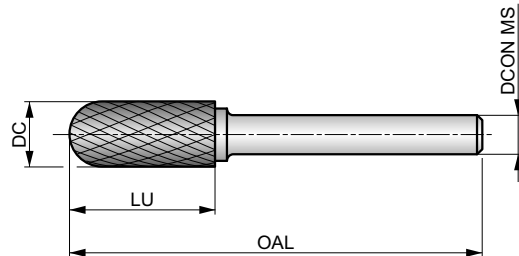

HM	C	Bright
DC		



Workpiece material group suitability. Recommended operating speed (RPM) on page 229.

P1.1	P1.2	P1.3	P2.1	P2.2	P2.3	P3.1	P3.2	P3.3	P4.1	P4.2	P4.3	M1.1	M1.2
M2.1	M2.2	M2.3	M3.1	M3.2	M3.3	M4.1	M4.2	K1.1	K1.2	K1.3	K2.1	K2.2	K2.3
K3.1	K3.2	K3.3	K4.1	K4.2	K4.3	K4.4	K4.5	K5.1	K5.2	K5.3	N3.1	N3.2	N3.3
S1.1	S1.2	S1.3	S2.1	S2.2	S3.1	S3.2	S4.1	S4.2	H1.1	H2.1	H2.2	H3.1	H3.2
H4.1	H4.2												

DC ≤ 6.00 mm: DCON MS tolerance h6; DC > 6.00 mm: Brazed on steel shank with DCON MS tolerance h7.
Products from this series are also available in set. Please see P880 or P890.

Product	DC	DCON MS	LU	OAL
	[mm]	[mm]	[mm]	[mm]
P8053.0X3.0	3.00	3.00	14.00	38.0
P8056.3X3.0	6.30	3.00	12.70	45.0
P8056.0X6.0	6.00	6.00	18.00	50.0
P8058.0X6.0	8.00	6.00	19.00	64.0
P8059.6X6.0	9.60	6.00	19.00	64.0
P80512.7X6.0	12.70	6.00	25.00	70.0
P80516.0X6.0	16.00	6.00	25.00	70.0



P805C



Rotary Burr - Ball Nosed Cylinder, Shape C, TiAlN Coating

DC double cut flute style with close spaced edges for trimming and deburring contours and circular arcs. Carbide design for cutting diameter up to 6 mm; above 6 mm carbide head with toughened and hardened steel shank. TiAlN coating for increased tool life, reduced friction and improved swarf evacuation.

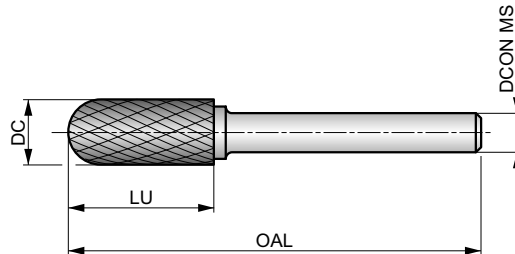

HM	C	TiAlN
DC	DORMER	



Workpiece material group suitability. Recommended operating speed (RPM) on page 229.

P1.1	P1.2	P1.3	P2.1	P2.2	P2.3	P3.1	P3.2	P3.3	P4.1	P4.2	P4.3	M1.1	M1.2
M2.1	M2.2	M2.3	M3.1	M3.2	M3.3	M4.1	M4.2	K1.1	K1.2	K1.3	K2.1	K2.2	K2.3
K3.1	K3.2	K3.3	K4.1	K4.2	K4.3	K4.4	K4.5	K5.1	K5.2	K5.3	N3.1	N3.2	N3.3
S1.1	S1.2	S1.3	S2.1	S2.2	S3.1	S3.2	S4.1	S4.2	H1.1	H2.1	H2.2	H3.1	H3.2
H4.1	H4.2												

DC ≤ 6.00 mm: DCON MS tolerance h6; DC > 6.00 mm: Brazed on steel shank with DCON MS tolerance h7.
Products from this series are also available in set. Please see P880.

Product	DC [mm]	DCON MS [mm]	LU [mm]	OAL [mm]
P805C3.0X3.0	3.00	3.00	14.00	38.0
P805C6.0X6.0	6.00	6.00	18.00	50.0
P805C8.0X6.0	8.00	6.00	19.00	64.0
P805C9.6X6.0	9.60	6.00	19.00	64.0
P805C12.7X6.0	12.70	6.00	25.00	70.0



P807



Rotary Burr - Ball, Shape D, Bright Finish

DC double cut flute style with close spaced edges for intricate carving, metal engraving and welding preparation. Carbide design for cutting diameter up to 6 mm; above 6 mm carbide head with toughened and hardened steel shank.

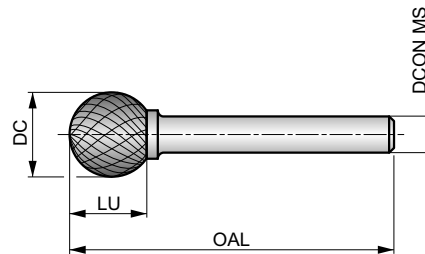

HM	Bright
DC	



Workpiece material group suitability. Recommended operating speed (RPM) on page 229.

P1.1	P1.2	P1.3	P2.1	P2.2	P2.3	P3.1	P3.2	P3.3	P4.1	P4.2	P4.3	M1.1	M1.2
M2.1	M2.2	M2.3	M3.1	M3.2	M3.3	M4.1	M4.2	K1.1	K1.2	K1.3	K2.1	K2.2	K2.3
K3.1	K3.2	K3.3	K4.1	K4.2	K4.3	K4.4	K4.5	K5.1	K5.2	K5.3	N3.1	N3.2	N3.3
S1.1	S1.2	S1.3	S2.1	S2.2	S3.1	S3.2	S4.1	S4.2	H1.1	H2.1	H2.2	H3.1	H3.2
H4.1	H4.2												

DC ≤ 6.00 mm: DCON MS tolerance h6; DC > 6.00 mm: Brazed on steel shank with DCON MS tolerance h7.
Products from this series are also available in set. Please see P880.

Product	DC [mm]	DCON MS [mm]	LU [mm]	OAL [mm]
P8073.0X3.0	3.00	3.00	2.50	38.0
P8074.0X3.0	4.00	3.00	3.40	38.0
P8076.3X3.0	6.30	3.00	5.00	38.0
P8076.0X6.0	6.00	6.00	4.70	50.0
P8078.0X6.0	8.00	6.00	6.00	52.0
P8079.6X6.0	9.60	6.00	8.00	54.0
P80712.7X6.0	12.70	6.00	11.00	56.0
P80716.0X6.0	16.00	6.00	14.00	59.0



P807C



Rotary Burr - Ball, Shape D, TiAlN Coating

DC double cut flute style with close spaced edges for intricate carving, metal engraving and welding preparation. Carbide design for cutting diameter up to 6 mm; above 6 mm carbide head with toughened and hardened steel shank. TiAlN coating for increased tool life, reduced friction and improved swarf evacuation.

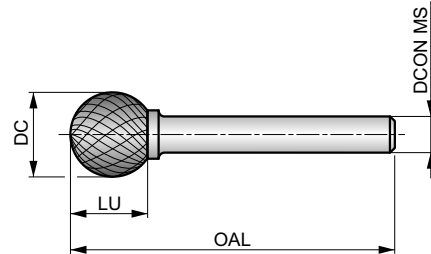

HM		
DC		



Workpiece material group suitability. Recommended operating speed (RPM) on page 229.

P1.1	P1.2	P1.3	P2.1	P2.2	P2.3	P3.1	P3.2	P3.3	P4.1	P4.2	P4.3	M1.1	M1.2
M2.1	M2.2	M2.3	M3.1	M3.2	M3.3	M4.1	M4.2	K1.1	K1.2	K1.3	K2.1	K2.2	K2.3
K3.1	K3.2	K3.3	K4.1	K4.2	K4.3	K4.4	K4.5	K5.1	K5.2	K5.3	N3.1	N3.2	N3.3
S1.1	S1.2	S1.3	S2.1	S2.2	S3.1	S3.2	S4.1	S4.2	H1.1	H2.1	H2.2	H3.1	H3.2
H4.1	H4.2												

DC ≤ 6.00 mm: DCON MS tolerance h6; DC > 6.00 mm: Brazed on steel shank with DCON MS tolerance h7.
 Products from this series are also available in set. Please see P880.

Product	DC [mm]	DCON MS [mm]	LU [mm]	OAL [mm]
P807C3.0X3.0	3.00	3.00	2.50	38.0
P807C6.0X6.0	6.00	6.00	4.70	50.0
P807C8.0X6.0	8.00	6.00	6.00	52.0
P807C9.6X6.0	9.60	6.00	8.00	54.0
P807C12.7X6.0	12.70	6.00	11.00	56.0



P809



Rotary Burr - Oval, Shape E

DC double cut flute style with close spaced edges for round edge contouring. Carbide design for cutting diameter up to 6 mm; above 6 mm carbide head with toughend and hardened steel shank.

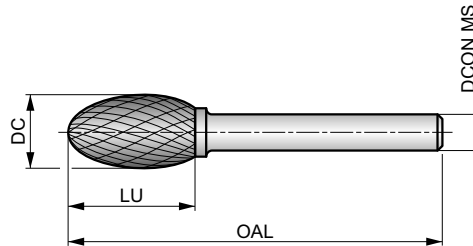

HM	E	Bright
DC		



Workpiece material group suitability. Recommended operating speed (RPM) on page 229.

P1.1	P1.2	P1.3	P2.1	P2.2	P2.3	P3.1	P3.2	P3.3	P4.1	P4.2	P4.3	M1.1	M1.2
M2.1	M2.2	M2.3	M3.1	M3.2	M3.3	M4.1	M4.2	K1.1	K1.2	K1.3	K2.1	K2.2	K2.3
K3.1	K3.2	K3.3	K4.1	K4.2	K4.3	K4.4	K4.5	K5.1	K5.2	K5.3	N3.1	N3.2	N3.3
S1.1	S1.2	S1.3	S2.1	S2.2	S3.1	S3.2	S4.1	S4.2	H1.1	H2.1	H2.2	H3.1	H3.2
H4.1	H4.2												

DC ≤ 6.00 mm: DCON MS tolerance h6; DC > 6.00 mm: Brazed on steel shank with DCON MS tolerance h7.
Products from this series are also available in set. Please see P880.

Product	DC [mm]	DCON MS [mm]	LU [mm]	OAL [mm]
P8093.0X3.0	3.00	3.00	6.00	38.0
P8096.3X3.0	6.30	3.00	9.50	42.0
P8096.0X6.0	6.00	6.00	10.00	50.0
P8098.0X6.0	8.00	6.00	15.00	60.0
P8099.6X6.0	9.60	6.00	16.00	60.0
P80912.7X6.0	12.70	6.00	22.00	67.0
P80916.0X6.0	16.00	6.00	25.00	70.0



P811



Rotary Burr - Ball Nosed Tree, Shape F, Bright Finish

DC double cut flute style with close spaced edges for multi-angle contouring, rounding of edges and cutting into hard to reach areas. Carbide design for cutting diameter up to 6 mm; above 6 mm carbide head with toughened and hardened steel shank.

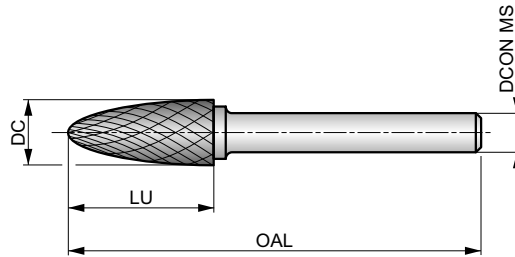

HM	F	Bright
DC	DORMER	



Workpiece material group suitability. Recommended operating speed (RPM) on page 229.

P1.1	P1.2	P1.3	P2.1	P2.2	P2.3	P3.1	P3.2	P3.3	P4.1	P4.2	P4.3	M1.1	M1.2
M2.1	M2.2	M2.3	M3.1	M3.2	M3.3	M4.1	M4.2	K1.1	K1.2	K1.3	K2.1	K2.2	K2.3
K3.1	K3.2	K3.3	K4.1	K4.2	K4.3	K4.4	K4.5	K5.1	K5.2	K5.3	N3.1	N3.2	N3.3
S1.1	S1.2	S1.3	S2.1	S2.2	S3.1	S3.2	S4.1	S4.2	H1.1	H2.1	H2.2	H3.1	H3.2
H4.1	H4.2												

DC ≤ 6.00 mm: DCON MS tolerance h6; DC > 6.00 mm: Brazed on steel shank with DCON MS tolerance h7.
Products from this series are also available in set. Please see P880 or P890.

Product	DC [mm]	DCON MS [mm]	LU [mm]	OAL [mm]
P8113.0X3.0	3.00	3.00	14.00	38.0
P8116.3X3.0	6.30	3.00	12.70	45.0
P8116.0X6.0	6.00	6.00	18.00	50.0
P8118.0X6.0	8.00	6.00	20.00	65.0
P8119.6X6.0	9.60	6.00	19.00	64.0
P81112.7X6.0	12.70	6.00	25.00	70.0
P81116.0X6.0	16.00	6.00	25.00	70.0



P811C



Rotary Burr - Ball Nosed Tree, Shape F, TiAlN Coating

DC double cut flute style with close spaced edges for multi-angle contouring, rounding of edges and cutting into hard to reach areas. Carbide design for cutting diameter up to 6 mm; above 6 mm carbide head with tough hard steel shank. TiAlN coating for increased tool life, reduced friction and improved swarf evacuation.

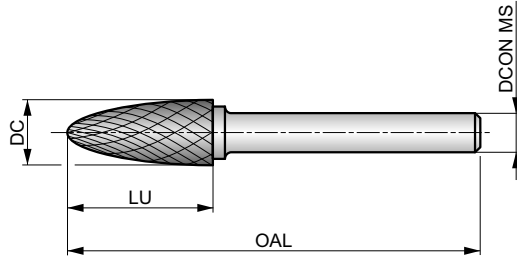

HM	F	TiAlN
DC	DORMER	



Workpiece material group suitability. Recommended operating speed (RPM) on page 229.

P1.1	P1.2	P1.3	P2.1	P2.2	P2.3	P3.1	P3.2	P3.3	P4.1	P4.2	P4.3	M1.1	M1.2
M2.1	M2.2	M2.3	M3.1	M3.2	M3.3	M4.1	M4.2	K1.1	K1.2	K1.3	K2.1	K2.2	K2.3
K3.1	K3.2	K3.3	K4.1	K4.2	K4.3	K4.4	K4.5	K5.1	K5.2	K5.3	N3.1	N3.2	N3.3
S1.1	S1.2	S1.3	S2.1	S2.2	S3.1	S3.2	S4.1	S4.2	H1.1	H2.1	H2.2	H3.1	H3.2
H4.1	H4.2												

DC ≤ 6.00 mm: DCON MS tolerance h6; DC > 6.00 mm: Brazed on steel shank with DCON MS tolerance h7.
Products from this series are also available in set. Please see P880.

Product	DC [mm]	DCON MS [mm]	LU [mm]	OAL [mm]
P811C3.0X3.0	3.00	3.00	14.00	38.0
P811C6.0X6.0	6.00	6.00	18.00	50.0
P811C9.6X6.0	9.60	6.00	19.00	64.0
P811C12.7X6.0	12.70	6.00	25.00	70.0



P813



Rotary Burr - Pointed Tree, Shape G, Bright Finish

DC double cut flute style with close spaced edges for multi-angle contouring and cutting narrow angles in hard to reach areas. Carbide design for cutting diameter up to 6 mm; above 6 mm carbide head with toughened and hardened steel shank.

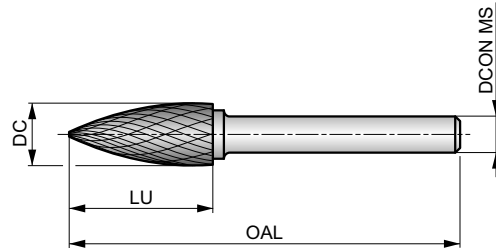

HM	G	Bright
DC		



Workpiece material group suitability. Recommended operating speed (RPM) on page 229.

P1.1	P1.2	P1.3	P2.1	P2.2	P2.3	P3.1	P3.2	P3.3	P4.1	P4.2	P4.3	M1.1	M1.2
M2.1	M2.2	M2.3	M3.1	M3.2	M3.3	M4.1	M4.2	K1.1	K1.2	K1.3	K2.1	K2.2	K2.3
K3.1	K3.2	K3.3	K4.1	K4.2	K4.3	K4.4	K4.5	K5.1	K5.2	K5.3	N3.1	N3.2	N3.3
S1.1	S1.2	S1.3	S2.1	S2.2	S3.1	S3.2	S4.1	S4.2	H1.1	H2.1	H2.2	H3.1	H3.2
H4.1	H4.2												

DC ≤ 6.00 mm: DCON MS tolerance h6; DC > 6.00 mm: Brazed on steel shank with DCON MS tolerance h7.
 Products from this series are also available in set. Please see P880 or P890.

Product	DC [mm]	DCON MS [mm]	LU [mm]	OAL [mm]
P8133.0X3.0	3.00	3.00	14.00	38.0
P8136.3X3.0	6.30	3.00	12.70	45.0
P8136.0X6.0	6.00	6.00	18.00	50.0
P8138.0X6.0	8.00	6.00	19.00	64.0
P8139.6X6.0	9.60	6.00	19.00	64.0
P81312.7X6.0	12.70	6.00	25.00	70.0
P81316.0X6.0	16.00	6.00	25.00	70.0



P813C



Rotary Burr - Pointed Tree, Shape G, TiAlN Coating

DC double cut flute style with close spaced edges for multi-angle contouring and cutting narrow angles in hard to reach areas. Carbide design for cutting diameter up to 6 mm; above 6 mm carbide head with tough hard steel shank. TiAlN coating for increased tool life, reduced friction and improved swarf evacuation.

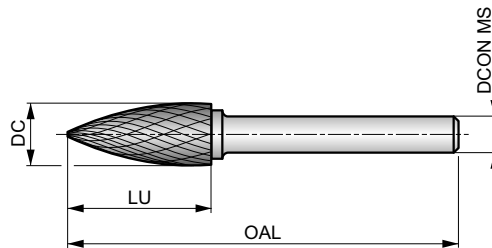

HM	G	TiAlN
DC	DORMER	



Workpiece material group suitability. Recommended operating speed (RPM) on page 229.

P1.1	P1.2	P1.3	P2.1	P2.2	P2.3	P3.1	P3.2	P3.3	P4.1	P4.2	P4.3	M1.1	M1.2
M2.1	M2.2	M2.3	M3.1	M3.2	M3.3	M4.1	M4.2	K1.1	K1.2	K1.3	K2.1	K2.2	K2.3
K3.1	K3.2	K3.3	K4.1	K4.2	K4.3	K4.4	K4.5	K5.1	K5.2	K5.3	N3.1	N3.2	N3.3
S1.1	S1.2	S1.3	S2.1	S2.2	S3.1	S3.2	S4.1	S4.2	H1.1	H2.1	H2.2	H3.1	H3.2
H4.1	H4.2												

DC ≤ 6.00 mm: DCON MS tolerance h6; DC > 6.00 mm: Brazed on steel shank with DCON MS tolerance h7.
Products from this series are also available in set. Please see P880.

Product	DC [mm]	DCON MS [mm]	LU [mm]	OAL [mm]
P813C3.0X3.0	3.00	3.00	14.00	38.0
P813C6.0X6.0	6.00	6.00	18.00	50.0
P813C9.6X6.0	9.60	6.00	19.00	64.0
P813C12.7X6.0	12.70	6.00	25.00	70.0



P815



Rotary Burr - Flame, Shape H, Bright Finish

DC double cut flute style with close spaced edges for round edge contouring and welding preparation. Carbide design for cutting diameter up to 6 mm; above 6 mm carbide head with toughened and hardened steel shank.

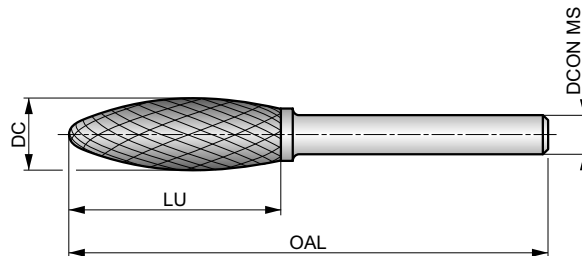

HM	H	Bright
DC	DORMER	



Workpiece material group suitability. Recommended operating speed (RPM) on page 229.

P1.1	P1.2	P1.3	P2.1	P2.2	P2.3	P3.1	P3.2	P3.3	P4.1	P4.2	P4.3	M1.1	M1.2
M2.1	M2.2	M2.3	M3.1	M3.2	M3.3	M4.1	M4.2	K1.1	K1.2	K1.3	K2.1	K2.2	K2.3
K3.1	K3.2	K3.3	K4.1	K4.2	K4.3	K4.4	K4.5	K5.1	K5.2	K5.3	N3.1	N3.2	N3.3
S1.1	S1.2	S1.3	S2.1	S2.2	S3.1	S3.2	S4.1	S4.2	H1.1	H2.1	H2.2	H3.1	H3.2
H4.1	H4.2												

DC ≤ 6.00 mm: DCON MS tolerance h6; DC > 6.00 mm: Brazed on steel shank with DCON MS tolerance h7.
Products from this series are also available in set. Please see P880.

Product	DC [mm]	DCON MS [mm]	LU [mm]	OAL [mm]
P8153.0X3.0	3.00	3.00	6.00	38.0
P8156.0X6.0	6.00	6.00	14.00	50.0
P8158.0X6.0	8.00	6.00	19.00	64.0
P8159.6X6.0	9.60	6.00	19.00	65.0
P81512.7X6.0	12.70	6.00	32.00	77.0
P81516.0X6.0	16.00	6.00	36.00	81.0



P815C



Rotary Burr - Flame, Shape H, TiAlN Coating

DC double cut flute style with close spaced edges for round edge contouring and welding preparation. Carbide head with toughened and hardened steel shank. TiAlN coating for increased tool life, reduced friction and improved swarf evacuation.

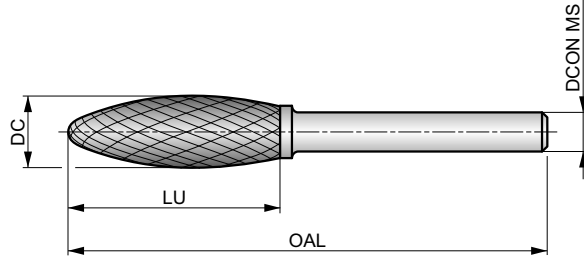

HM	H	TiAlN
DC	DORMER	



Workpiece material group suitability. Recommended operating speed (RPM) on page 229.

P1.1	P1.2	P1.3	P2.1	P2.2	P2.3	P3.1	P3.2	P3.3	P4.1	P4.2	P4.3	M1.1	M1.2
M2.1	M2.2	M2.3	M3.1	M3.2	M3.3	M4.1	M4.2	K1.1	K1.2	K1.3	K2.1	K2.2	K2.3
K3.1	K3.2	K3.3	K4.1	K4.2	K4.3	K4.4	K4.5	K5.1	K5.2	K5.3	N3.1	N3.2	N3.3
S1.1	S1.2	S1.3	S2.1	S2.2	S3.1	S3.2	S4.1	S4.2	H1.1	H2.1	H2.2	H3.1	H3.2
H4.1	H4.2												

Brazed on Steel Shank with DCON MS tolerance h7.

Product	DC [mm]	DCON MS [mm]	LU [mm]	OAL [mm]
P815C8.0X6.0	8.00	6.00	19.00	64.0
P815C12.7X6.0	12.70	6.00	32.00	77.0



P817



Rotary Burr - 60° Countersink, Shape J

DC double cut flute style with close spaced edges for chamfering, making v-cuts and welding preparation. Carbide design for cutting diameter up to 6 mm; above 6 mm carbide head with toughened and hardened steel shank.

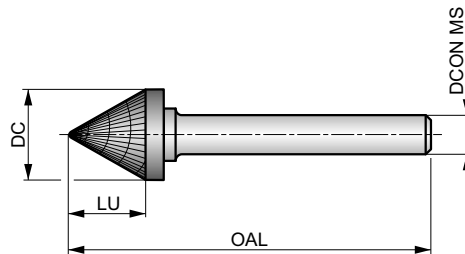

HM	J	Bright
60°	DC	DORMER



Workpiece material group suitability. Recommended operating speed (RPM) on page 229.

P1.1	P1.2	P1.3	P2.1	P2.2	P2.3	P3.1	P3.2	P3.3	P4.1	P4.2	P4.3	M1.1	M1.2
M2.1	M2.2	M2.3	M3.1	M3.2	M3.3	M4.1	M4.2	K1.1	K1.2	K1.3	K2.1	K2.2	K2.3
K3.1	K3.2	K3.3	K4.1	K4.2	K4.3	K4.4	K4.5	K5.1	K5.2	K5.3	N3.1	N3.2	N3.3
S1.1	S1.2	S1.3	S2.1	S2.2	S3.1	S3.2	S4.1	S4.2	H1.1	H2.1	H2.2	H3.1	H3.2
H4.1	H4.2												

DC≤6.00 mm: DCON MS tolerance h6; DC>6.00 mm: Brazed on steel shank with DCON MS tolerance h7.

Product	DC [mm]	DCON MS [mm]	LU [mm]	OAL [mm]
P8173.0X3.0	3.00	3.00	2.50	38.0
P8176.0X6.0	6.00	6.00	4.00	50.0
P8179.6X6.0	9.60	6.00	8.00	56.0
P81712.7X6.0	12.70	6.00	11.00	59.0
P81716.0X6.0	16.00	6.00	14.50	63.0



P819



Rotary Burr - 90° Countersink, Shape K

DC double cut flute style with close spaced edges for chamfering, making v-cuts and welding preparation. Carbide design for cutting diameter up to 6 mm; above 6 mm carbide head with toughened and hardened steel shank.

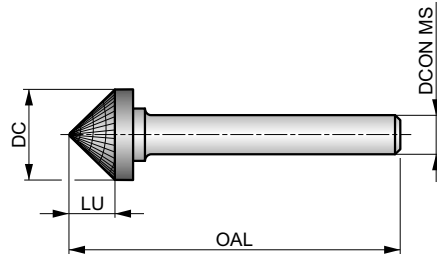

HM	K	Bright
90°	DC	DORMER



Workpiece material group suitability. Recommended operating speed (RPM) on page 229.

P1.1	P1.2	P1.3	P2.1	P2.2	P2.3	P3.1	P3.2	P3.3	P4.1	P4.2	P4.3	M1.1	M1.2
M2.1	M2.2	M2.3	M3.1	M3.2	M3.3	M4.1	M4.2	K1.1	K1.2	K1.3	K2.1	K2.2	K2.3
K3.1	K3.2	K3.3	K4.1	K4.2	K4.3	K4.4	K4.5	K5.1	K5.2	K5.3	N3.1	N3.2	N3.3
S1.1	S1.2	S1.3	S2.1	S2.2	S3.1	S3.2	S4.1	S4.2	H1.1	H2.1	H2.2	H3.1	H3.2
H4.1	H4.2												

DC ≤ 6.00 mm: DCON MS tolerance h6; DC > 6.00 mm: Brazed on steel shank with DCON MS tolerance h7.

Product	DC [mm]	DCON MS [mm]	LU [mm]	OAL [mm]
P8193.0X3.0	3.00	3.00	1.50	38.0
P8196.0X6.0	6.00	6.00	3.00	50.0
P8199.6X6.0	9.60	6.00	4.70	53.0
P81912.7X6.0	12.70	6.00	6.30	55.0
P81916.0X6.0	16.00	6.00	8.00	57.0



P821



Rotary Burr - Ball Nosed Cone, Shape L, Bright Finish

DC double cut flute style with close spaced edges for enlarging holes, rounding edges and surface finishing in tight narrow angles or other hard to reach areas. Carbide design for cutting diameter up to 6 mm; above 6 mm carbide head with toughened and hardened steel shank.

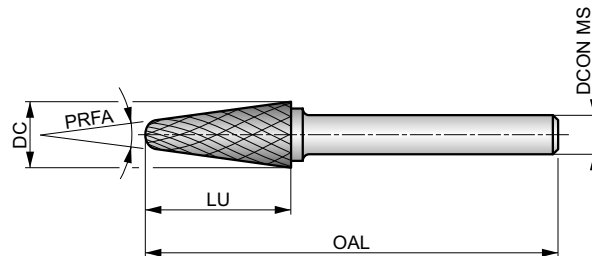

HM		Bright
DC		



Workpiece material group suitability. Recommended operating speed (RPM) on page 229.

P1.1	P1.2	P1.3	P2.1	P2.2	P2.3	P3.1	P3.2	P3.3	P4.1	P4.2	P4.3	M1.1	M1.2
M2.1	M2.2	M2.3	M3.1	M3.2	M3.3	M4.1	M4.2	K1.1	K1.2	K1.3	K2.1	K2.2	K2.3
K3.1	K3.2	K3.3	K4.1	K4.2	K4.3	K4.4	K4.5	K5.1	K5.2	K5.3	N3.1	N3.2	N3.3
S1.1	S1.2	S1.3	S2.1	S2.2	S3.1	S3.2	S4.1	S4.2	H1.1	H2.1	H2.2	H3.1	H3.2
H4.1	H4.2												

DC ≤ 6.00 mm: DCON MS tolerance h6; DC > 6.00 mm: Brazed on steel shank with DCON MS tolerance h7.
Products from this series are also available in set. Please see P880 or P890.

Product	DC	DCON MS	LU	OAL	PRFA
	[mm]	[mm]	[mm]	[mm]	[°]
P8213.0X3.0	3.00	3.00	14.00	38.0	8
P8216.0X6.0	6.00	6.00	18.00	50.0	14
P8218.0X6.0	8.00	6.00	25.40	70.0	14
P8219.6X6.0	9.60	6.00	30.00	76.0	14
P82112.7X6.0	12.70	6.00	32.00	77.0	14
P82116.0X6.0	16.00	6.00	33.00	78.0	14



P821C



Rotary Burr - Ball Nosed Cone, Shape L, TiAlN Coating

DC double cut flute style with close spaced edges for enlarging holes, rounding edges and surface finishing in tight narrow angles or other hard to reach areas. Carbide design for cutting diameter up to 6 mm; above 6 mm carbide head with toughened and hardened steel shank. TiAlN coating for increased tool life.

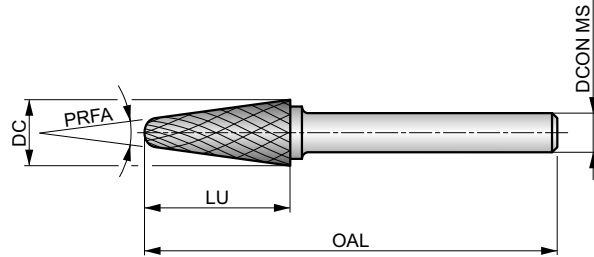

HM	L	TiAlN
DC	DORMER	



Workpiece material group suitability. Recommended operating speed (RPM) on page 229.

P1.1	P1.2	P1.3	P2.1	P2.2	P2.3	P3.1	P3.2	P3.3	P4.1	P4.2	P4.3	M1.1	M1.2
M2.1	M2.2	M2.3	M3.1	M3.2	M3.3	M4.1	M4.2	K1.1	K1.2	K1.3	K2.1	K2.2	K2.3
K3.1	K3.2	K3.3	K4.1	K4.2	K4.3	K4.4	K4.5	K5.1	K5.2	K5.3	N3.1	N3.2	N3.3
S1.1	S1.2	S1.3	S2.1	S2.2	S3.1	S3.2	S4.1	S4.2	H1.1	H2.1	H2.2	H3.1	H3.2
H4.1	H4.2												

DC ≤ 6.00 mm: DCON MS tolerance h6; DC > 6.00 mm: Brazed on steel shank with DCON MS tolerance h7.

Product	DC [mm]	DCON MS [mm]	LU [mm]	OAL [mm]	PRFA [°]
P821C3.0X3.0	3.00	3.00	14.00	38.0	8
P821C12.7X6.0	12.70	6.00	32.00	77.0	14



P823



Rotary Burr - Cone, Shape M

DC double cut flute style with close spaced edges for enlarging holes, surface finishing and cutting narrow angles in hard to reach areas. Carbide design for cutting diameter up to 6 mm; above 6 mm carbide head with toughened and hardened steel shank.

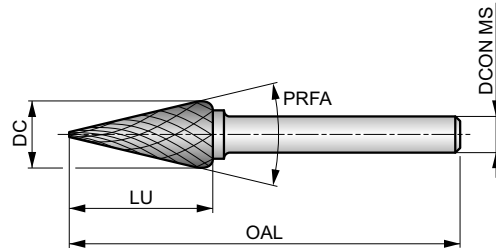

HM	M	Bright
DC	DORMER	



Workpiece material group suitability. Recommended operating speed (RPM) on page 229.

P1.1	P1.2	P1.3	P2.1	P2.2	P2.3	P3.1	P3.2	P3.3	P4.1	P4.2	P4.3	M1.1	M1.2
M2.1	M2.2	M2.3	M3.1	M3.2	M3.3	M4.1	M4.2	K1.1	K1.2	K1.3	K2.1	K2.2	K2.3
K3.1	K3.2	K3.3	K4.1	K4.2	K4.3	K4.4	K4.5	K5.1	K5.2	K5.3	N3.1	N3.2	N3.3
S1.1	S1.2	S1.3	S2.1	S2.2	S3.1	S3.2	S4.1	S4.2	H1.1	H2.1	H2.2	H3.1	H3.2
H4.1	H4.2												

DC ≤ 6.00 mm: DCON MS tolerance h6; DC > 6.00 mm: Brazed on steel shank with DCON MS tolerance h7.
Products from this series are also available in set. Please see P880.

Product	DC	DCON MS	LU	OAL	PRFA
	[mm]	[mm]	[mm]	[mm]	[°]
P8233.0X3.0	3.00	3.00	11.00	38.0	14
P8236.3X3.0	6.30	3.00	12.70	49.0	22
P8236.0X6.0	6.00	6.00	20.00	50.0	14
P8239.6X6.0	9.60	6.00	16.00	64.0	28
P82312.7X6.0	12.70	6.00	22.00	71.0	28
P82316.0X6.0	16.00	6.00	25.00	71.0	31



P825



Rotary Burr - Inverted Cone, Shape N

DC double cut flute style with close spaced edges for making inverted v-cuts and rear side chamfering. Carbide design for cutting diameter up to 6 mm; above 6 mm carbide head with toughened and hardened steel shank.

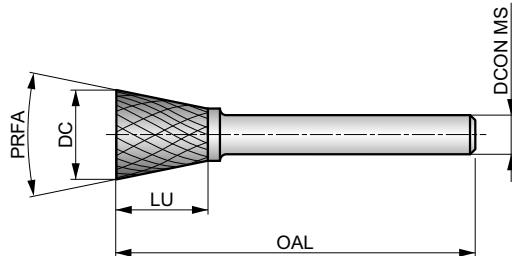

HM		Bright
DC		

Workpiece material group suitability. Recommended operating speed (RPM) on page 229.

P1.1	P1.2	P1.3	P2.1	P2.2	P2.3	P3.1	P3.2	P3.3	P4.1	P4.2	P4.3	M1.1	M1.2
M2.1	M2.2	M2.3	M3.1	M3.2	M3.3	M4.1	M4.2	K1.1	K1.2	K1.3	K2.1	K2.2	K2.3
K3.1	K3.2	K3.3	K4.1	K4.2	K4.3	K4.4	K4.5	K5.1	K5.2	K5.3	N3.1	N3.2	N3.3
S1.1	S1.2	S1.3	S2.1	S2.2	S3.1	S3.2	S4.1	S4.2	H1.1	H2.1	H2.2	H3.1	H3.2
H4.1	H4.2												

DC ≤ 6.00 mm: DCON MS tolerance h6; DC > 6.00 mm: Brazed on steel shank with DCON MS tolerance h7.

Product	DC [mm]	DCON MS [mm]	LU [mm]	OAL [mm]	PRFA [°]
P8253.0X3.0	3.00	3.00	4.00	38.0	10
P8256.3X3.0	6.30	3.00	6.00	39.0	12
P8256.0X6.0	6.00	6.00	8.00	50.0	10
P8259.6X6.0	9.60	6.00	9.50	55.0	16
P82512.7X6.0	12.70	6.00	12.70	58.0	28
P82516.0X6.0	16.00	6.00	19.00	64.0	18



P701



Rotary Burr - Cylinder without endcut, Shape A

ST single cut flute style with chipbreakers and medium spaced edge for trimming and deburring surfaces. Carbide design for cutting diameter equal to 6 mm; above 6 mm carbide head with toughened and hardened steel shank. First choice for steels.

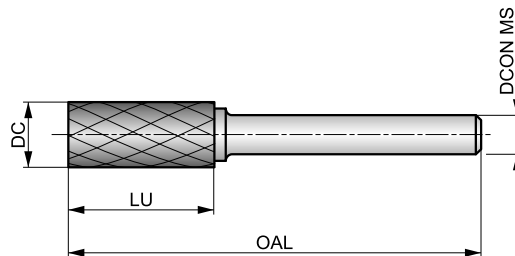

HM		
ST		

Workpiece material group suitability. Recommended operating speed (RPM) on page 229.

P1.1	P1.2	P1.3	P2.1	P2.2	P2.3	P3.1	P3.2	P3.3	P4.1	P4.2	P4.3
■	■	■	■	■	■	■	■	■	■	■	■

DC=6.00 mm: DCON MS tolerance h6; DC>6.00 mm: Brazed on steel shank with DCON MS tolerance h7.

Product	DC [mm]	DCON MS [mm]	LU [mm]	OAL [mm]
P7016.0X6.0	6.00	6.00	18.00	50.0
P7018.0X6.0	8.00	6.00	19.00	64.0
P7019.6X6.0	9.60	6.00	19.00	64.0
P70112.7X6.0	12.70	6.00	25.00	70.0



P703



Rotary Burr - Cylinder with endcut, Shape B

ST single cut flute style with chipbreakers and medium spaced edge for trimming and deburring surfaces and right-angled corners. Carbide design for cutting diameter equal to 6 mm; above 6 mm carbide head with toughened and hardened steel shank. First choice for steels.

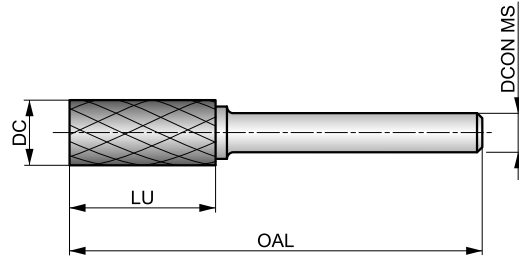

HM	B	
Bright	ST	



Workpiece material group suitability. Recommended operating speed (RPM) on page 229.

P1.1	P1.2	P1.3	P2.1	P2.2	P2.3	P3.1	P3.2	P3.3	P4.1	P4.2	P4.3
■	■	■	■	■	■	■	■	■	■	■	■

DC=6.00 mm: DCON MS tolerance h6; DC>6.00 mm: Brazed on steel shank with DCON MS tolerance h7.
Products from this series are also available in set. Please see P880.

Product	DC [mm]	DCON MS [mm]	LU [mm]	OAL [mm]
P7036.0X6.0	6.00	6.00	18.00	50.0
P7038.0X6.0	8.00	6.00	19.00	64.0
P7039.6X6.0	9.60	6.00	19.00	64.0
P70312.7X6.0	12.70	6.00	25.00	70.0



P705



Rotary Burr - Ball Nosed Cylinder, Shape C

ST single cut flute style with chipbreakers and medium spaced edge for trimming and deburring contours and circular arcs. Carbide design for cutting diameter equal to 6 mm; above 6 mm carbide head with toughened and hardened steel shank. First choice for steels.

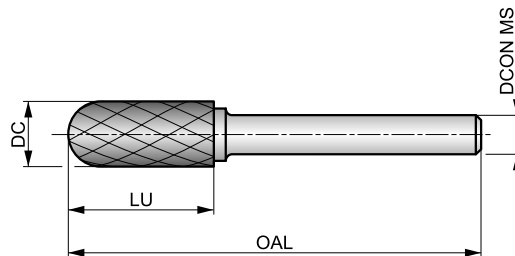

HM	C	Bright
ST	DORMER	



Workpiece material group suitability. Recommended operating speed (RPM) on page 229.

P1.1	P1.2	P1.3	P2.1	P2.2	P2.3	P3.1	P3.2	P3.3	P4.1	P4.2	P4.3
■	■	■	■	■	■	■	■	■	■	■	■

DC=6.00 mm: DCON MS tolerance h6; DC>6.00 mm: Brazed on steel shank with DCON MS tolerance h7.
Products from this series are also available in set. Please see P880.

Product	DC [mm]	DCON MS [mm]	LU [mm]	OAL [mm]
P7056.0X6.0	6.00	6.00	18.00	50.0
P7058.0X6.0	8.00	6.00	19.00	64.0
P7059.6X6.0	9.60	6.00	19.00	64.0
P70512.7X6.0	12.70	6.00	25.00	70.0



P707

DORMER



Rotary Burr - Ball, Shape D

ST single cut flute style with chipbreakers and medium spaced edge for intricate carving, metal engraving and welding preparation. Carbide design for cutting diameter equal to 6 mm; above 6 mm carbide head with toughened and hardened steel shank. First choice for steels.

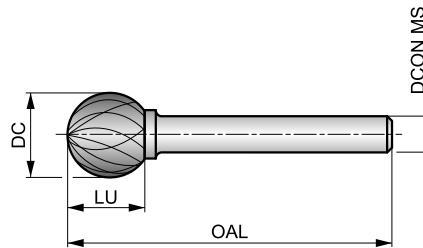

HM	D	Bright
ST		



Workpiece material group suitability. Recommended operating speed (RPM) on page 229.

P1.1	P1.2	P1.3	P2.1	P2.2	P2.3	P3.1	P3.2	P3.3	P4.1	P4.2	P4.3
■	■	■	■	■	■	■	■	■	■	■	■

DC=6.00 mm: DCON MS tolerance h6; DC>6.00 mm: Brazed on steel shank with DCON MS tolerance h7.
Products from this series are also available in set. Please see P880.

Product	DC	DCON MS	LU	OAL
	[mm]	[mm]	[mm]	[mm]
P7076.0X6.0	6.00	6.00	4.70	50.0
P7078.0X6.0	8.00	6.00	6.00	52.0
P7079.6X6.0	9.60	6.00	8.00	54.0
P70712.7X6.0	12.70	6.00	11.00	56.0



P709



Rotary Burr - Oval, Shape E

ST single cut flute style with chipbreakers and medium spaced edge for round edge contouring. Carbide head with toughened and hardened steel shank. First choice for steels.

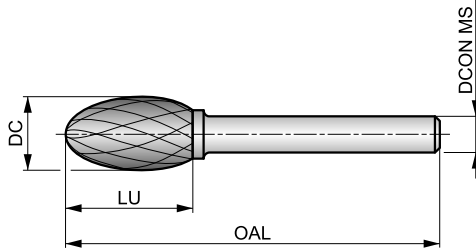

HM	E	Bright
ST	DORMER	



Workpiece material group suitability. Recommended operating speed (RPM) on page 229.

P1.1	P1.2	P1.3	P2.1	P2.2	P2.3	P3.1	P3.2	P3.3	P4.1	P4.2	P4.3
■	■	■	■	■	■	■	■	■	■	■	■

Brazed on Steel Shank with DCON MS tolerance h7.

Product	DC	DCON MS	LU	OAL
	[mm]	[mm]	[mm]	[mm]
P70912.7X6.0	12.70	6.00	22.00	67.0



P711



Rotary Burr - Ball Nosed Tree, Shape F

ST single cut flute style with chipbreakers and medium spaced edge for multi-angle contouring, rounding of edges and cutting into hard to reach areas. Carbide design for cutting diameter equal to 6 mm; above 6 mm carbide head with toughend and hardened steel shank. First choice for steels.

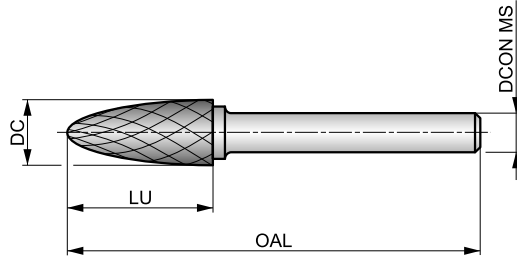

HM	F	Bright
ST		



Workpiece material group suitability. Recommended operating speed (RPM) on page 229.

P1.1	P1.2	P1.3	P2.1	P2.2	P2.3	P3.1	P3.2	P3.3	P4.1	P4.2	P4.3
■	■	■	■	■	■	■	■	■	■	■	■

DC=6.00 mm: DCON MS tolerance h6; DC>6.00 mm: Brazed on steel shank with DCON MS tolerance h7.
Products from this series are also available in set. Please see P880.

Product	DC [mm]	DCON MS [mm]	LU [mm]	OAL [mm]
P7116.0X6.0	6.00	6.00	18.00	50.0
P7118.0X6.0	8.00	6.00	20.00	65.0
P7119.6X6.0	9.60	6.00	19.00	64.0
P71112.7X6.0	12.70	6.00	25.00	70.0



P713



Rotary Burr - Pointed Tree, Shape G

ST single cut flute style with chipbreakers and medium spaced edge for multi-angle contouring and cutting narrow angles in hard to reach areas. Carbide design for cutting diameter equal to 6 mm; above 6 mm carbide head with toughened and hardened steel shank. First choice for steels.

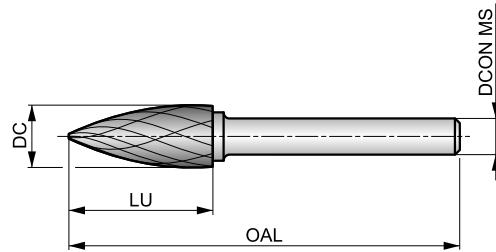

HM	G	Bright
ST		



Workpiece material group suitability. Recommended operating speed (RPM) on page 229.

P1.1	P1.2	P1.3	P2.1	P2.2	P2.3	P3.1	P3.2	P3.3	P4.1	P4.2	P4.3
■	■	■	■	■	■	■	■	■	■	■	■

DC=6.00 mm: DCON MS tolerance h6; DC>6.00 mm: Brazed on steel shank with DCON MS tolerance h7.

Product	DC [mm]	DCON MS [mm]	LU [mm]	OAL [mm]
P7136.0X6.0	6.00	6.00	18.00	50.0
P7138.0X6.0	8.00	6.00	19.00	64.0
P7139.6X6.0	9.60	6.00	19.00	64.0
P71312.7X6.0	12.70	6.00	25.00	70.0



P715



Rotary Burr - Flame, Shape H

ST single cut flute style with chipbreakers and medium spaced edge for round edge contouring and welding preparation. Carbide head with toughened and hardened steel shank. First choice for steels.

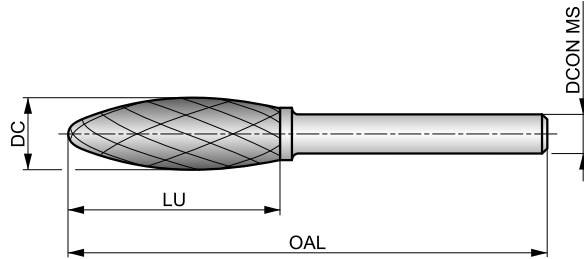

HM	H	Bright
ST	DORMER	



Workpiece material group suitability. Recommended operating speed (RPM) on page 229.

P1.1	P1.2	P1.3	P2.1	P2.2	P2.3	P3.1	P3.2	P3.3	P4.1	P4.2	P4.3
■	■	■	■	■	■	■	■	■	■	■	■

Brazed on Steel Shank with DCON MS tolerance h7.

Product	DC	DCON MS	LU	OAL
	[mm]	[mm]	[mm]	[mm]
P7158.0X6.0	8.00	6.00	19.00	64.0
P71512.7X6.0	12.70	6.00	32.00	77.0



P721



Rotary Burr - Ball Nosed Cone, Shape L

ST single cut flute style with chipbreakers and medium spaced edge for enlarging holes, rounding edges and surface-finishing in tight narrow angles or other hard to reach areas. Carbide head with toughened and hardened steel shank. First choice for steels.

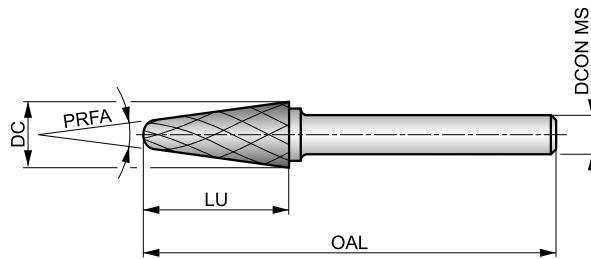

HM		Bright
ST		



Workpiece material group suitability. Recommended operating speed (RPM) on page 229.

P1.1	P1.2	P1.3	P2.1	P2.2	P2.3	P3.1	P3.2	P3.3	P4.1	P4.2	P4.3
■	■	■	■	■	■	■	■	■	■	■	■

Brazed on Steel Shank with DCON MS tolerance h7.
 Products from this series are also available in set. Please see P880.

Product	DC [mm]	DCON MS [mm]	LU [mm]	OAL [mm]	PRFA [°]
P72110.0X6.0	10.00	6.00	20.00	65.0	14
P7219.6X6.0	9.60	6.00	30.00	76.0	14
P72112.7X6.0	12.70	6.00	32.00	77.0	14



P601



Rotary Burr - Cylinder without endcut, Shape A

VA single cut flute style with medium spaced edges for trimming and deburring surfaces. Carbide design for cutting diameter up to 6 mm; above 6 mm carbide head with toughened and hardened steel shank. First choice for stainless steels.

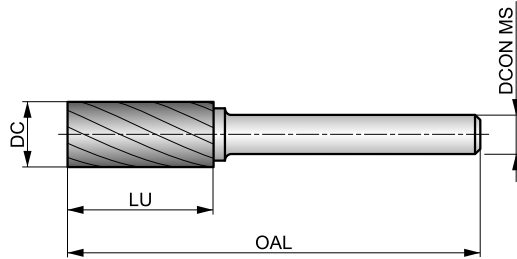

HM	A	Bright
VA	DORMER	

Workpiece material group suitability. Recommended operating speed (RPM) on page 229.

M1.1	M1.2	M2.1	M2.2	M2.3	M3.1	M3.2	M3.3	M4.1	M4.2	K4.1	K4.2
■	■	■	■	■	■	■	■	■	■	☑	☑

DC≤6.00 mm: DCON MS tolerance h6; DC>6.00 mm: Brazed on steel shank with DCON MS tolerance h7.
Products from this series are also available in set. Please see P880.

Product	DC	DCON MS	LU	OAL
	[mm]	[mm]	[mm]	[mm]
P6013.0X3.0	3.00	3.00	14.00	38.0
P6016.3X3.0	6.30	3.00	12.70	45.0
P6016.0X6.0	6.00	6.00	18.00	50.0
P6018.0X6.0	8.00	6.00	19.00	64.0
P6019.6X6.0	9.60	6.00	19.00	64.0
P60112.7X6.0	12.70	6.00	25.00	70.0



P605



Rotary Burr - Ball Nosed Cylinder, Shape C

VA single cut flute style with medium spaced edges for trimming and deburring contours and circular arcs. Carbide design for cutting diameter up to 6 mm; above 6 mm carbide head with toughened and hardened steel shank. First choice for stainless steels.

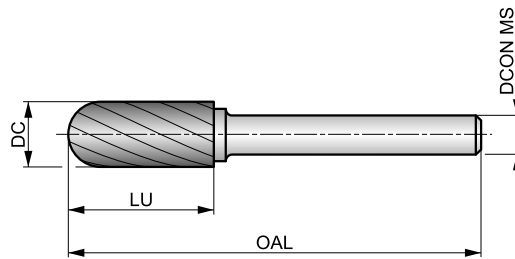

HM	C	Bright
VA	DORMER	



Workpiece material group suitability. Recommended operating speed (RPM) on page 229.

M1.1	M1.2	M2.1	M2.2	M2.3	M3.1	M3.2	M3.3	M4.1	M4.2	K4.1	K4.2
■	■	■	■	■	■	■	■	■	■	▣	▣

DC ≤ 6.00 mm: DCON MS tolerance h6; DC > 6.00 mm: Brazed on steel shank with DCON MS tolerance h7.
 Products from this series are also available in set. Please see P880.

Product	DC [mm]	DCON MS [mm]	LU [mm]	OAL [mm]
P6053.0X3.0	3.00	3.00	14.00	38.0
P6056.3X3.0	6.30	3.00	12.70	45.0
P6056.0X6.0	6.00	6.00	18.00	50.0
P6058.0X6.0	8.00	6.00	19.00	64.0
P6059.6X6.0	9.60	6.00	19.00	64.0
P60512.7X6.0	12.70	6.00	25.00	70.0



P607

DORMER



Rotary Burr - Ball, Shape D

VA single cut flute style with medium spaced edges for intricate carving, metal engraving and welding preparation. Carbide design for cutting diameter up to 6 mm; above 6 mm carbide head with toughened and hardened steel shank. First choice for stainless steels.

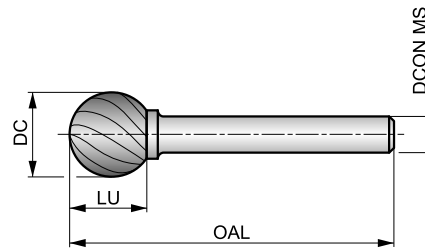

HM	D	Bright
VA		



Workpiece material group suitability. Recommended operating speed (RPM) on page 229.

M1.1	M1.2	M2.1	M2.2	M2.3	M3.1	M3.2	M3.3	M4.1	M4.2	K4.1	K4.2
■	■	■	■	■	■	■	■	■	■	☑	☑

DC≤6.00 mm: DCON MS tolerance h6; DC>6.00 mm: Brazed on steel shank with DCON MS tolerance h7.
Products from this series are also available in set. Please see P880.

Product	DC	DCON MS	LU	OAL
	[mm]	[mm]	[mm]	[mm]
P6073.0X3.0	3.00	3.00	2.50	38.0
P6076.3X3.0	6.30	3.00	5.00	38.0
P6076.0X6.0	6.00	6.00	4.70	50.0
P6078.0X6.0	8.00	6.00	6.00	52.0
P6079.6X6.0	9.60	6.00	8.00	54.0
P60712.7X6.0	12.70	6.00	11.00	56.0



P609

Rotary Burr - Oval, Shape E

VA single cut flute style with medium spaced edges for round edge contouring. Carbide head with toughened and hardened steel shank. First choice for stainless steels.

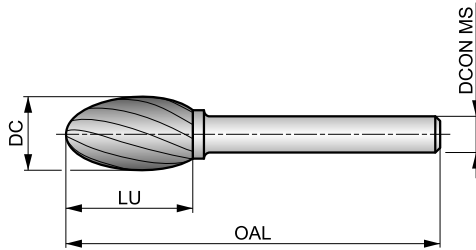

HM	E	Bright
VA	DORMER	



Workpiece material group suitability. Recommended operating speed (RPM) on page 229.

M1.1	M1.2	M2.1	M2.2	M2.3	M3.1	M3.2	M3.3	M4.1	M4.2	K4.1	K4.2
■	■	■	■	■	■	■	■	■	■	▣	▣

Brazed on Steel Shank with DCON MS tolerance h7.

Product	DC [mm]	DCON MS [mm]	LU [mm]	OAL [mm]
P6098.0X6.0	8.00	6.00	15.00	60.0
P6099.6X6.0	9.60	6.00	16.00	60.0
P60912.7X6.0	12.70	6.00	22.00	67.0



P611



Rotary Burr - Ball Nosed Tree, Shape F

VA single cut flute style with medium spaced edges for multi-angle contouring, rounding of edges and cutting into hard to reach areas. Carbide design for cutting diameter up to 6 mm; above 6 mm carbide head with toughened and hardened steel shank. First choice for stainless steels.

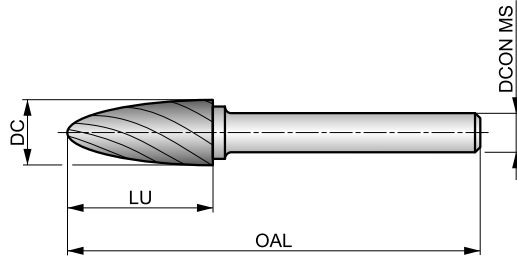

HM	F	Bright
VA	DORMER	



Workpiece material group suitability. Recommended operating speed (RPM) on page 229.

M1.1	M1.2	M2.1	M2.2	M2.3	M3.1	M3.2	M3.3	M4.1	M4.2	K4.1	K4.2
■	■	■	■	■	■	■	■	■	■	☑	☑

DC ≤ 6.00 mm: DCON MS tolerance h6; DC > 6.00 mm: Brazed on steel shank with DCON MS tolerance h7.
Products from this series are also available in set. Please see P880.

Product	DC	DCON MS	LU	OAL
	[mm]	[mm]	[mm]	[mm]
P6113.0X3.0	3.00	3.00	14.00	38.0
P6116.3X3.0	6.30	3.00	12.70	45.0
P6116.0X6.0	6.00	6.00	18.00	50.0
P6118.0X6.0	8.00	6.00	20.00	65.0
P6119.6X6.0	9.60	6.00	19.00	64.0
P6112.7X6.0	12.70	6.00	25.00	70.0



P613



Rotary Burr - Pointed Tree, Shape G

VA single cut flute style with medium spaced edges for multi-angle contouring and cutting narrow angles in hard to reach areas. Carbide design for cutting diameter equal to 6 mm; above 6 mm carbide head with toughened and hardened steel shank. First choice for stainless steels.

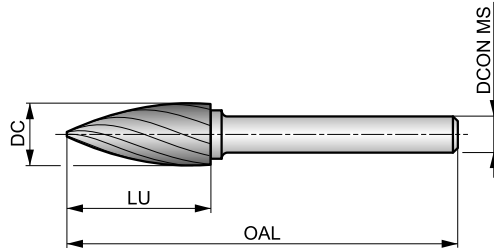

HM	G	Bright
VA	DORMER	



Workpiece material group suitability. Recommended operating speed (RPM) on page 229.

M1.1	M1.2	M2.1	M2.2	M2.3	M3.1	M3.2	M3.3	M4.1	M4.2	K4.1	K4.2
■	■	■	■	■	■	■	■	■	■	▣	▣

DC=6.00 mm: DCON MS tolerance h6; DC>6.00 mm: Brazed on steel shank with DCON MS tolerance h7.

Product	DC [mm]	DCON MS [mm]	LU [mm]	OAL [mm]
P6136.0X6.0	6.00	6.00	18.00	50.0
P6138.0X6.0	8.00	6.00	19.00	64.0
P6139.6X6.0	9.60	6.00	19.00	64.0
P61312.7X6.0	12.70	6.00	25.00	70.0



P615



Rotary Burr - Flame, Shape H

VA single cut flute style with medium spaced edges for round edge contouring and welding preparation. Carbide head with toughened and hardened steel shank. First choice for stainless steels.

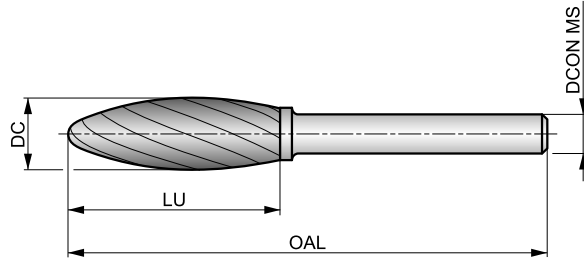

HM	H	Bright
VA	DORMER	



Workpiece material group suitability. Recommended operating speed (RPM) on page 229.

M1.1	M1.2	M2.1	M2.2	M2.3	M3.1	M3.2	M3.3	M4.1	M4.2	K4.1	K4.2
■	■	■	■	■	■	■	■	■	■	☑	☑

Brazed on Steel Shank with DCON MS tolerance h7.

Product	DC	DCON MS	LU	OAL
	[mm]	[mm]	[mm]	[mm]
P6158.0X6.0	8.00	6.00	19.00	64.0
P6159.6X6.0	9.60	6.00	19.00	65.0
P61512.7X6.0	12.70	6.00	32.00	77.0



P621



Rotary Burr - Ball Nosed Cone, Shape L

VA single cut flute style with medium spaced edges for enlarging holes, rounding edges and surface finishing in tight narrow angles or other hard to reach areas. Carbide head with toughened and hardened steel shank. First choice for stainless steels.

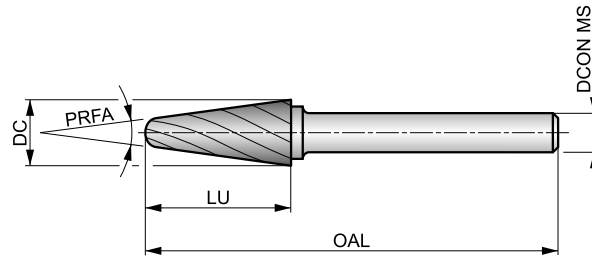

HM	L	Bright
VA	DORMER	



Workpiece material group suitability. Recommended operating speed (RPM) on page 229.

M1.1	M1.2	M2.1	M2.2	M2.3	M3.1	M3.2	M3.3	M4.1	M4.2	K4.1	K4.2
■	■	■	■	■	■	■	■	■	■	▣	▣

Brazed on Steel Shank with DCON MS tolerance h7.

Products from this series are also available in set. Please see P880.

Product	DC	DCON MS	LU	OAL	PRFA
	[mm]	[mm]	[mm]	[mm]	[°]
P6218.0X6.0	8.00	6.00	25.40	70.0	14
P62110.0X6.0	10.00	6.00	20.00	65.0	14
P62112.7X6.0	12.70	6.00	32.00	77.0	14



P831

DORMER



Rotary Burr - Cylinder without endcut, Shape A

AL single cut flute style with wide spaced edges for trimming and deburring surfaces. Carbide design for cutting diameter equal to 6 mm; above 6 mm carbide head with toughened and hardened steel shank. First choice for non-ferrous materials and plastics.

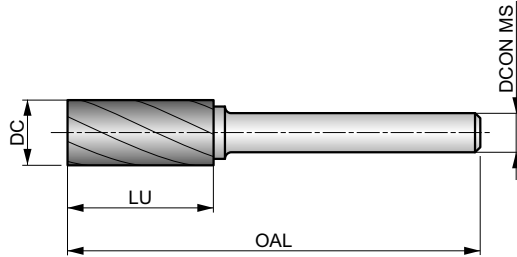

HM	A	Bright
AL	DORMER	



Workpiece material group suitability. Recommended operating speed (RPM) on page 229.

N1.1	N1.2	N1.3	N2.1	N2.2	N2.3	N3.1	N3.2	N4.1	N4.2	N4.3	S1.1
■	■	■	■	■	■	▣	▣	■	■	▣	▣

DC=6.00 mm: DCON MS tolerance h6; DC>6.00 mm: Brazed on steel shank with DCON MS tolerance h7.

Product	DC [mm]	DCON MS [mm]	LU [mm]	OAL [mm]
P8316.0X6.0	6.00	6.00	18.00	50.0
P8319.6X6.0	9.60	6.00	19.00	64.0
P83112.7X6.0	12.70	6.00	25.00	70.0



P833

DORMER



Rotary Burr - Cylinder with endcut, Shape B

AL single cut flute style with wide spaced edges for trimming and deburring surfaces and right-angled corners. Carbide design for cutting diameter equal to 6 mm; above 6 mm carbide head with toughened and hardened steel shank. First choice for non-ferrous materials and plastics.

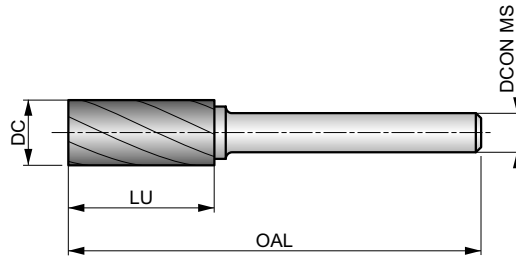

HM	B	
Bright	AL	



Workpiece material group suitability. Recommended operating speed (RPM) on page 229.

N1.1	N1.2	N1.3	N2.1	N2.2	N2.3	N3.1	N3.2	N4.1	N4.2	N4.3	S1.1
■	■	■	■	■	■	▣	▣	■	■	▣	▣

DC=6.00 mm: DCON MS tolerance h6; DC>6.00 mm: Brazed on steel shank with DCON MS tolerance h7.

Product	DC [mm]	DCON MS [mm]	LU [mm]	OAL [mm]
P8336.0X6.0	6.00	6.00	18.00	50.0
P8339.6X6.0	9.60	6.00	19.00	64.0
P83312.7X6.0	12.70	6.00	25.00	70.0



P835



Rotary Burr - Ball Nosed Cylinder, Shape C

AL single cut flute style with wide spaced edges for for trimming and deburring contours and circular arcs. Carbide design for cutting diameter equal to 6 mm; above 6 mm carbide head with toughened and hardened steel shank. First choice for non-ferrous materials and plastics.

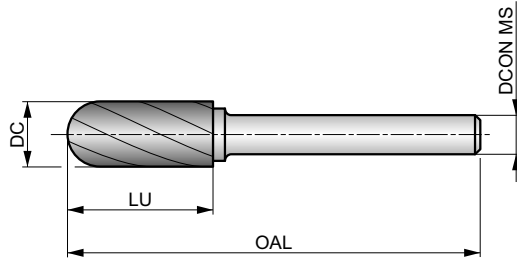

HM	C	Bright
AL	DORMER	



Workpiece material group suitability. Recommended operating speed (RPM) on page 229.

N1.1	N1.2	N1.3	N2.1	N2.2	N2.3	N3.1	N3.2	N4.1	N4.2	N4.3	S1.1
■	■	■	■	■	■	▣	▣	■	■	▣	▣

DC=6.00 mm: DCON MS tolerance h6; DC>6.00 mm: Brazed on steel shank with DCON MS tolerance h7.

Product	DC [mm]	DCON MS [mm]	LU [mm]	OAL [mm]
P8356.0X6.0	6.00	6.00	18.00	50.0
P8359.6X6.0	9.60	6.00	19.00	64.0
P83512.7X6.0	12.70	6.00	25.00	70.0



P837



Rotary Burr - Ball, Shape D

AL single cut flute style with wide spaced edges for intricate carving, metal engraving and welding preparation. Carbide design for cutting diameter equal to 6 mm; above 6 mm carbide head with toughened and hardened steel shank. First choice for non-ferrous materials and plastics.

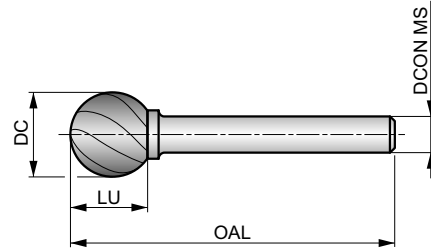

HM		Bright
AL		



Workpiece material group suitability. Recommended operating speed (RPM) on page 229.

N1.1	N1.2	N1.3	N2.1	N2.2	N2.3	N3.1	N3.2	N4.1	N4.2	N4.3	S1.1
■	■	■	■	■	■	▣	▣	■	■	▣	▣

DC=6.00 mm: DCON MS tolerance h6; DC>6.00 mm: Brazed on steel shank with DCON MS tolerance h7.

Product	DC [mm]	DCON MS [mm]	LU [mm]	OAL [mm]
P8376.0X6.0	6.00	6.00	4.70	50.0
P8379.6X6.0	9.60	6.00	8.00	54.0
P83712.7X6.0	12.70	6.00	11.00	56.0



P841

DORMER



Rotary Burr - Ball Nosed Tree, Shape F

AL single cut flute style with wide spaced edges for multi-angle contouring, rounding of edges and cutting into hard to reach areas. Carbide design for cutting diameter equal to 6 mm; above 6 mm carbide head with toughened and hardened steel shank. First choice for non-ferrous materials and plastics.

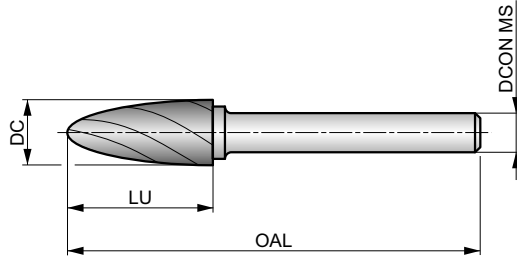

HM	F	Bright
AL	DORMER	



Workpiece material group suitability. Recommended operating speed (RPM) on page 229.

N1.1	N1.2	N1.3	N2.1	N2.2	N2.3	N3.1	N3.2	N4.1	N4.2	N4.3	S1.1
■	■	■	■	■	■	▣	▣	■	■	▣	▣

DC=6.00 mm: DCON MS tolerance h6; DC>6.00 mm: Brazed on steel shank with DCON MS tolerance h7.

Product	DC	DCON MS	LU	OAL
	[mm]	[mm]	[mm]	[mm]
P8416.0X6.0	6.00	6.00	18.00	50.0
P8419.6X6.0	9.60	6.00	19.00	64.0
P84112.7X6.0	12.70	6.00	25.00	70.0



P842



Rotary Burr - Ball Nosed Cone, Shape L

AL single cut flute style - wide spaced edges for enlarging holes, rounding edges and surface finishing in tight narrow angles or other hard to reach areas. Carbide design for cutting diameter equal to 6 mm; above 6 mm carbide head with toughened and hardened steel shank. First choice for non-ferrous materials and plastics.

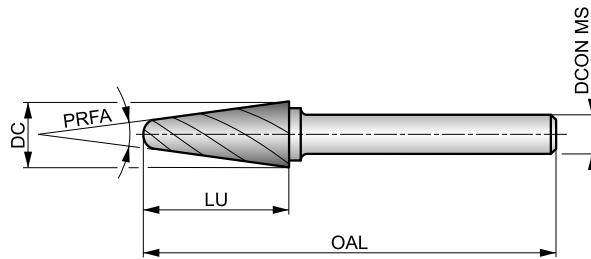

HM	L	Bright
AL		



Workpiece material group suitability. Recommended operating speed (RPM) on page 229.

N1.1	N1.2	N1.3	N2.1	N2.2	N2.3	N3.1	N3.2	N4.1	N4.2	N4.3	S1.1
■	■	■	■	■	■	▣	▣	■	■	▣	▣

DC=6.00 mm: DCON MS tolerance h6; DC>6.00 mm: Brazed on steel shank with DCON MS tolerance h7.

Product	DC	DCON MS	LU	OAL	PRFA
	[mm]	[mm]	[mm]	[mm]	[°]
P8426.0X6.0	6.00	6.00	18.00	50.0	14
P8429.6X6.0	9.60	6.00	30.00	76.0	14
P84212.7X6.0	12.70	6.00	32.00	77.0	14



P501



Rotary Burr - Cylinder without endcut, Shape A

AS single cut flute style with light left-hand cross cut for trimming and deburring surfaces. Solid carbide shank for rigidity. First choice for superalloys.

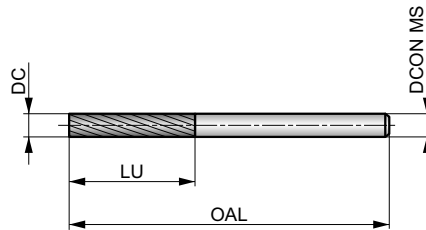

HM	A	Bright
AS	DORMER	



Workpiece material group suitability. Recommended operating speed (RPM) on page 229.

M3.1	M3.2	M3.3	M4.1	M4.2	S1.1	S1.2	S1.3	S2.1	S2.2	S3.1	S3.2	S4.1	S4.2
☑	☑	☑	☑	☑	☐	☐	☐	☐	☐	☐	☐	☐	☐

DCON MS tolerance h6.

Products from this series are also available in set. Please see P880.

Product	DC [mm]	DCON MS [mm]	LU [mm]	OAL [mm]
P5013.0X3.0	3.00	3.00	12.00	38.0



P505



Rotary Burr - Ball Nosed Cylinder, Shape C

AS single cut flute style with light left-hand cross cut for trimming and deburring contours and circular arcs. Solid carbide shank for rigidity. First choice for superalloys.

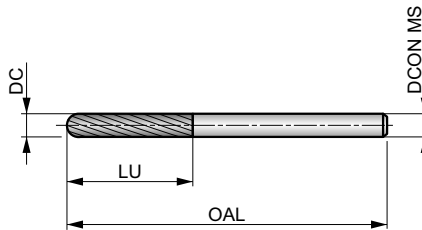

HM	C	Bright
AS	DORMER	



Workpiece material group suitability. Recommended operating speed (RPM) on page 229.

M3.1	M3.2	M3.3	M4.1	M4.2	S1.1	S1.2	S1.3	S2.1	S2.2	S3.1	S3.2	S4.1	S4.2
☑	☑	☑	☑	☑	☐	☐	☐	☐	☐	☐	☐	☐	☐

DCON MS tolerance h6.
Products from this series are also available in set. Please see P880.

Product	DC	DCON MS	LU	OAL
	[mm]	[mm]	[mm]	[mm]
P5053.0X3.0	3.00	3.00	14.00	38.0



P507



Rotary Burr - Ball, Shape D

AS single cut flute style with light left-hand cross cut for intricate carving, metal engraving and welding preparation. Solid carbide shank for rigidity. First choice for superalloys.

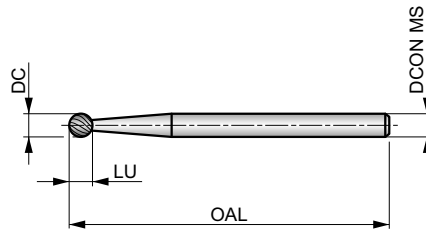

HM	D	Bright
AS		



Workpiece material group suitability. Recommended operating speed (RPM) on page 229.

M3.1	M3.2	M3.3	M4.1	M4.2	S1.1	S1.2	S1.3	S2.1	S2.2	S3.1	S3.2	S4.1	S4.2
<input checked="" type="checkbox"/>	<input checked="" type="checkbox"/>	<input checked="" type="checkbox"/>	<input checked="" type="checkbox"/>	<input checked="" type="checkbox"/>	<input type="checkbox"/>	<input type="checkbox"/>	<input type="checkbox"/>	<input type="checkbox"/>	<input type="checkbox"/>	<input type="checkbox"/>	<input type="checkbox"/>	<input type="checkbox"/>	<input type="checkbox"/>

DCON MS tolerance h6.

Products from this series are also available in set. Please see P880.

Product	DC	DCON MS	LU	OAL
	[mm]	[mm]	[mm]	[mm]
P5073.0X3.0	3.00	3.00	2.50	38.0



P509



Rotary Burr - Oval, Shape E

AS single cut flute style with light left-hand cross cut for round edge contouring. Solid carbide shank for rigidity. First choice for superalloys.

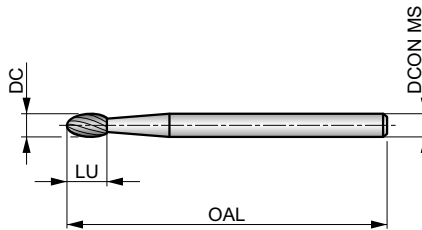

HM	E	Bright
AS	DORMER	



Workpiece material group suitability. Recommended operating speed (RPM) on page 229.

M3.1	M3.2	M3.3	M4.1	M4.2	S1.1	S1.2	S1.3	S2.1	S2.2	S3.1	S3.2	S4.1	S4.2
☑	☑	☑	☑	☑	☐	☐	☐	☐	☐	☐	☐	☐	☐

DCON MS tolerance h6.
Products from this series are also available in set. Please see P880.

Product	DC [mm]	DCON MS [mm]	LU [mm]	OAL [mm]
P5093.0X3.0	3.00	3.00	6.00	38.0



P511



Rotary Burr - Ball Nosed Tree, Shape F

AS single cut flute style with light left-hand cross cut for multi-angle contouring, rounding of edges and cutting into hard to reach areas. Solid carbide shank for rigidity. First choice for superalloys.

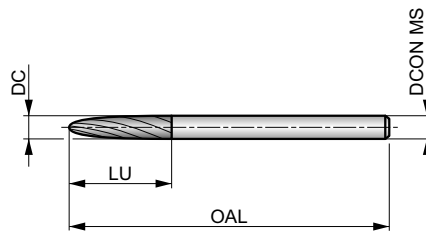

HM	F	Bright
AS		



Workpiece material group suitability. Recommended operating speed (RPM) on page 229.

M3.1	M3.2	M3.3	M4.1	M4.2	S1.1	S1.2	S1.3	S2.1	S2.2	S3.1	S3.2	S4.1	S4.2
<input checked="" type="checkbox"/>	<input checked="" type="checkbox"/>	<input checked="" type="checkbox"/>	<input checked="" type="checkbox"/>	<input checked="" type="checkbox"/>	<input type="checkbox"/>	<input type="checkbox"/>	<input type="checkbox"/>	<input type="checkbox"/>	<input type="checkbox"/>	<input type="checkbox"/>	<input type="checkbox"/>	<input type="checkbox"/>	<input type="checkbox"/>

DCON MS tolerance h6.

Products from this series are also available in set. Please see P880.

Product	DC [mm]	DCON MS [mm]	LU [mm]	OAL [mm]
P5113.0X3.0	3.00	3.00	14.00	38.0



P513



Rotary Burr - Pointed Tree, Shape G

AS single cut flute style with light left-hand cross cut for multi-angle contouring and cutting narrow angles in hard to reach areas. Solid carbide shank for rigidity. First choice for superalloys.

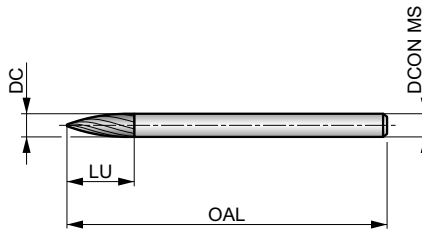

HM	G	Bright
AS	DORMER	



Workpiece material group suitability. Recommended operating speed (RPM) on page 229.

M3.1	M3.2	M3.3	M4.1	M4.2	S1.1	S1.2	S1.3	S2.1	S2.2	S3.1	S3.2	S4.1	S4.2
☑	☑	☑	☑	☑	☐	☐	☐	☐	☐	☐	☐	☐	☐

DCON MS tolerance h6.
Products from this series are also available in set. Please see P880.

Product	DC	DCON MS	LU	OAL
	[mm]	[mm]	[mm]	[mm]
P5133.0X3.0X8.0	3.00	3.00	8.00	38.0
P5133.0X3.0X14.0	3.00	3.00	14.00	38.0



P515



Rotary Burr - Flame, Shape H

AS single cut flute style with light left-hand cross cut for round edge contouring and welding preparation. Solid carbide shank for rigidity. First choice for superalloys.

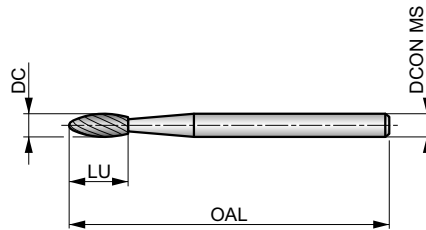

HM	H	Bright
AS	DORMER	



Workpiece material group suitability. Recommended operating speed (RPM) on page 229.

M3.1	M3.2	M3.3	M4.1	M4.2	S1.1	S1.2	S1.3	S2.1	S2.2	S3.1	S3.2	S4.1	S4.2
☑	☑	☑	☑	☑	■	■	■	■	■	■	■	■	■

DCON MS tolerance h6.

Products from this series are also available in set. Please see P880.

Product	DC [mm]	DCON MS [mm]	LU [mm]	OAL [mm]
P5153.0X3.0	3.00	3.00	6.00	38.0



P521



Rotary Burr - Ball Nosed Cone, Shape L

AS single cut flute style with light left-hand cross cut for enlarging holes, rounding edges and surface-finishing in tight narrow angles or other hard to reach areas. Solid carbide shank for rigidity. First choice for superalloys.

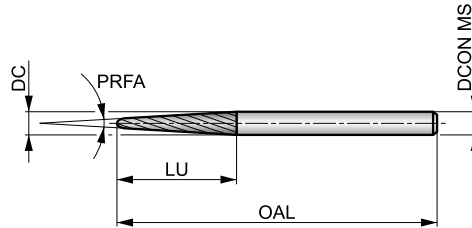

HM	L	Bright
AS	DORMER	



Workpiece material group suitability. Recommended operating speed (RPM) on page 229.

M3.1	M3.2	M3.3	M4.1	M4.2	S1.1	S1.2	S1.3	S2.1	S2.2	S3.1	S3.2	S4.1	S4.2
☑	☑	☑	☑	☑	☐	☐	☐	☐	☐	☐	☐	☐	☐

DCON MS tolerance h6.
Products from this series are also available in set. Please see P880.

Product	DC	DCON MS	LU	OAL	PRFA
	[mm]	[mm]	[mm]	[mm]	[°]
P5213.0X3.0	3.00	3.00	14.00	38.0	8



P523



Rotary Burr - Cone, Shape M

AS single cut flute style with light left-hand cross cut for enlarging holes, surface finishing and cutting narrow angles in hard to reach areas. Solid carbide shank for rigidity. First choice for superalloys.

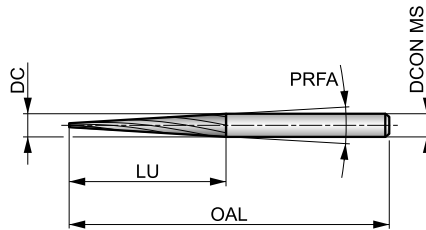

HM		Bright
AS		



Workpiece material group suitability. Recommended operating speed (RPM) on page 229.

M3.1	M3.2	M3.3	M4.1	M4.2	S1.1	S1.2	S1.3	S2.1	S2.2	S3.1	S3.2	S4.1	S4.2
☑	☑	☑	☑	☑	■	■	■	■	■	■	■	■	■

DCON MS tolerance h6.

Products from this series are also available in set. Please see P880.

Product	DC [mm]	DCON MS [mm]	LU [mm]	OAL [mm]	PRFA [°]
P5233.0X3.0	3.00	3.00	15.00	38.0	7



P843



Diamond Cut Router - 135° Drill Point

GRP diamond cut flute style with medium spaced edges for contouring, making cut-out shapes and holes. Solid carbide shank for rigidity. First choice for fibreglass and composite materials.

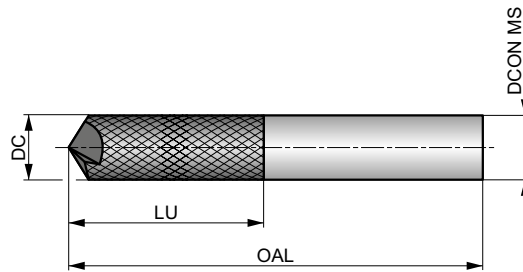

HM		Bright
	GRP	



Workpiece material group suitability. Recommended operating speed (RPM) on page 229.

N4.3

DCON MS tolerance h6.

Product	DC [mm]	DCON MS [mm]	LU [mm]	OAL [mm]
P8433.0X3.0	3.00	3.00	13.00	45.0
P8436.0X6.0	6.00	6.00	19.00	63.0
P8438.0X8.0	8.00	8.00	25.00	63.0



P844

DORMER



Diamond Cut Router - End Mill

GRP diamond cut flute style with medium spaced edges for contouring, groove and pocket milling and making cut-out shapes. Solid carbide shank for rigidity. First choice for fibreglass and composite materials.

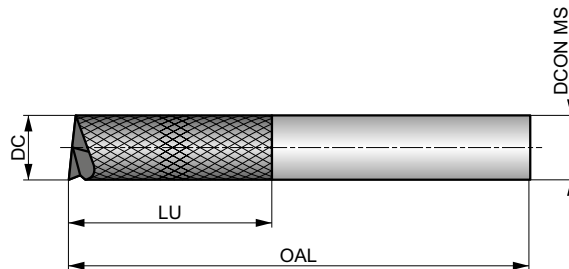

HM		Bright
	GRP	



Workpiece material group suitability. Recommended operating speed (RPM) on page 229.

N4.3

DCON MS tolerance h6.

Product	DC [mm]	DCON MS [mm]	LU [mm]	OAL [mm]
P8443.0X3.0	3.00	3.00	13.00	45.0
P8446.0X6.0	6.00	6.00	19.00	63.0
P8448.0X8.0	8.00	8.00	25.00	63.0



P100



1st Stage Rotary Burr for Broken Bolt Removal, Cylinder with End Cut

First stage broken bolt removal solid carbide burr. When a bolt is broken and needs to be extracted, first use P100 to flatten the broken bolt surface. Secondly use P101. This series of burrs makes sure the threaded hole is not damaged when removing the broken piece.

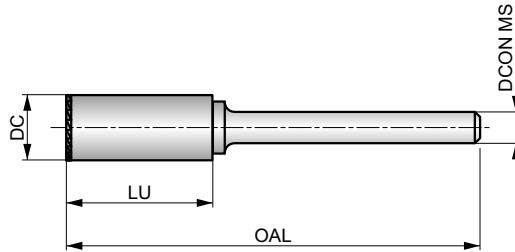

HM		Bright
BR	DORMER	



Workpiece material group suitability. Recommended operating speed (RPM) on page 229 and 'how to use the tool' on page 216.

P1.1	P1.2	P1.3	P2.1	P2.2	P2.3	P3.1	P3.2	P3.3	P4.1	P4.2	M1.1	M1.2	M2.1
■	■	■	■	■	■	■	■	■	■	■	■	■	■
M2.2	M2.3	M3.1	M3.2	M3.3									
■	■	■	■	■									

Product	DC	DCON MS	LU	OAL	
	[mm]	[mm]	[mm]	[mm]	
P1004.9	4.90	6.00	20.00	50.0	1/4-20; 24; 28; M6
P1006.4	6.40	6.00	5.00	50.0	5/16-18; 24; 32; M8
P1007.8	7.80	6.00	19.00	65.0	3/8-16; 24; M10
P1009.3	9.30	6.00	19.00	65.0	7/16-14; 20; M12
P10010.7	10.70	6.00	25.00	70.0	1/2-13; 20; M14



P101



2nd Stage Rotary Burr for Broken Bolt Removal, 150° Countersink

Second stage broken bolt removal solid carbide burr. When a bolt is broken and needs to be extracted, P101 creates a centerpoint into the flattened broken bolt. Prepare it for the 3rd stage, drilling the broken piece with a drill.

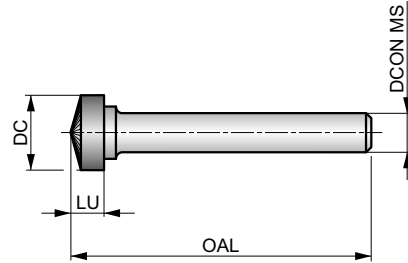

HM	Bright	150°
BR	DORMER	



Workpiece material group suitability. Recommended operating speed (RPM) on page 229 and 'how to use the tool' on page 216.

P1.1	P1.2	P1.3	P2.1	P2.2	P2.3	P3.1	P3.2	P3.3	P4.1	P4.2	M1.1	M1.2	M2.1
■	■	■	■	■	■	■	■	■	■	■	■	■	■
M2.2	M2.3	M3.1	M3.2	M3.3									
■	■	■	■	■									

Product	DC	DCON MS	LU	OAL	
	[mm]	[mm]	[mm]	[mm]	
P1014.9	4.90	6.00	20.00	50.0	1/4-20; 24; 28; M6
P1016.4	6.40	6.00	5.00	50.0	5/16-18; 24; 32; M8
P1017.8	7.80	6.00	5.00	50.0	3/8-16; 24; M10
P1019.3	9.30	6.00	5.00	50.0	7/16-14; 20; M12
P10110.7	10.70	6.00	5.00	50.0	1/2-13; 20; M14



P880

DORMER



Rotary Burr Set

Set of different rotary burrs in various shapes, sizes and forms.

A = Styles in Set, B = No. in Set, C = Rotary Burrs in Set.

Product	Nr.	A	B	C
P88001	Nr01	P803 + P805 + P807 + P809 + P813	5	P803 9.6 × 6.0; P805 9.6 × 6.0; P807 9.6 × 6.0; P809 9.6 × 6.0; P813 9.6 × 6.0
P88002	Nr02	P803C + P805C + P807C + P811C + P813C	5	P803C 9.6 × 6.0; P805C 9.6 × 6.0; P807C 9.6 × 6.0; P811C 9.6 × 6.0; P813C 9.6 × 6.0
P88003	Nr03	P601 + P605 + P607 + P611 + P621	5	P601 9.6 × 6.0; P605 9.6 × 6.0; P607 9.6 × 6.0; P611 9.6 × 6.0; P621 10.0 × 6.0
P88004	Nr04	P703 + P705 + P707 + P711 + P721	5	P703 9.6 × 6.0; P705 9.6 × 6.0; P707 9.6 × 6.0; P711 9.6 × 6.0; P721 10.0 × 6.0
P88006	Nr06	P501 + P505 + P507 + P509 + P511 + P513 + P515 + P521 + P523	10	P501 3.0 × 3.0; P505 3.0 × 3.0; P507 3.0 × 3.0; P509 3.0 × 3.0; P511 3.0 × 3.0; P513 3.0 × 3.0 × 8.0; P513 3.0 × 3.0 × 14.0; P515 3.0 × 3.0; P521 3.0 × 3.0; P523 3.0 × 3.0



P890



Rotary Burrs Display

Display of 40 pieces of solid burrs of the P8xx serie. DC double cut flute style with close spaced edges. Bright finish.

A = Styles in Set, B = No. in Set, C = Rotary Burrs in Set.

Product	Nr.	A	B	C
P89001	Nr01	P803 + P805 + P811 + P813 + P821	40	P803 (6.0 × 6.0; 8.0 × 6.0; 9.6 × 6.0; 12.7 × 6.0) × 2 P805 (6.0 × 6.0; 8.0 × 6.0; 9.6 × 6.0; 12.7 × 6.0) × 2 P811 (6.0 × 6.0; 8.0 × 6.0; 9.6 × 6.0; 12.7 × 6.0) × 2 P813 (6.0 × 6.0; 8.0 × 6.0; 9.6 × 6.0; 12.7 × 6.0) × 2 P821 (6.0 × 6.0; 8.0 × 6.0; 9.6 × 6.0; 12.7 × 6.0) × 2



ROTARY BURRS – GENERAL HINTS

General hints on carbide burrs

Carbide Burrs are widely used for preparing and finishing components in a wide range of materials. They are generally used by hand and mounted in air driven die-grinders.

Construction and Geometry

1. Toughened and hardened steel shanks improve rigidity and reduce the risk of bending or vibration.
2. Accurately ground shanks improve holding and reduce likelihood of spinning.
3. Special brazing elements prevent high temperature failure and also provide increased strength to withstand pressure and impact.
4. The universal Double Cut (DC) geometry is suitable for a wide range of materials and applications.
5. Material specific geometries are also available suited to Steel (ST), Stainless Steel (VA), Aluminium (AL), Super Alloys (AS) and Fibreglass (GRP).
6. Available with TiAlN coating to increase tool life in abrasive materials.
7. Ball nose burrs are ground with Skip Flute geometry. This provides active geometry towards the centre of the burr, improving the cutting action and reducing the chances of swarf build up and clogging.

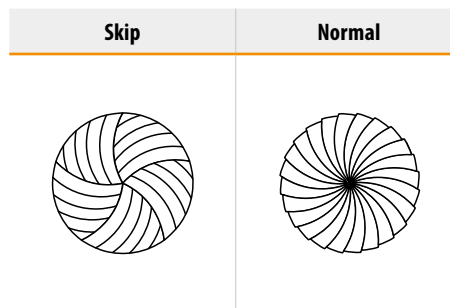

Safety first

1. High speed rotating tools are hazardous and can be dangerous if miss-used.
2. Always disconnect the die grinder from the air supply before attempting to change the burrs.
3. Check the condition of the die grinder and if possible use low vibration versions.
4. Always use the appropriate protective equipment and ensure anyone working close by is also protected.



Personal protective equipment must be worn at all times!



ROTARY BURRS – GENERAL HINTS

Recommendations

- Always use the appropriate speed rated die grinder.
- Routine maintenance of die grinders is important, ensure they are oiled and bearings are not worn.
- Always clean the clamping nut, collet and internal taper of the die grinder when changing a burr.
- Try to avoid mechanical shock and heavy impact of the burrs.
- Try to avoid thermal shock by not allowing the burr to become overheated.
- Don't plunge the burr too deep into the workpiece material or jam the bur into corners or channels.

Trouble shooting using burrs

Problem	Cause
Chipping of Burr Teeth	Running speed too low (revolutions per minute) can cause bouncing (chatter).
	Eccentricity (worn spindle, collet or bearings).
	Plunging and jamming the burr into the workpiece.
Clogging of Burr Teeth	Flute length or overall length too long.
	Incorrect geometry choice for workpiece material.
Premature Wear	Running speed too high (revolutions per minute) for size of burr and workpiece material.
	Eccentricity (worn spindle, collet or bearings).
Head Detaches from Shank	Running speed too high (revolutions per minute) causing overheating.
	Running for prolonged periods causing overheating.



DORMER PRAMET



EVERY MATERIAL

Machining steel, stainless steel, cast iron, super-alloys or non-ferrous materials, all are covered within our calculator app. Download it from your app store today. **Simply Reliable.**



THREAD MILLS





MILLING – GENERAL CONTENT

6		WMG & ISO 13399
10	SOLID MILLS	INSTRUCTIONS
19		HM MILLS
117		HSS-E-PM, HSS-E, HSS MILLS
201		TECHNICAL INFORMATION
212		ROTARY BURRS
292		THREAD MILLS
314	INDEXABLE MILLS	INSTRUCTIONS
328		NAVIGATORS
349		FACE MILLS
409		SQUARE SHOULDER MILLS
479		DEEP SHOULDER MILLS
508		SLOT MILLS
521		COPY MILLS
613		HIGH FEED MILLS (HFC)
645		CHAMFER & T-SLOT MILLS
667		OTHER INSERTS
691		TECHNICAL INFORMATION



THREAD MILLS – PAGE OVERVIEW



1 J205



2 Solid Carbide Thread Mill with Through Coolant and Countersink, Metric

Universal high performance tool to machine same or bigger diameters than the TDZ with the same pitch. Left or right-hand, through or blind holes almost down to the bottom. With 60° countersink for chamfering. Alcrona Pro coated for the best machining result with through coolant for better chip evacuation.

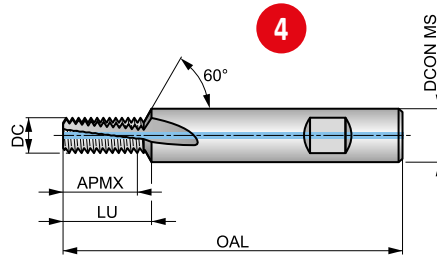

M	DORMER	2xD
HM		λ 10°
R	Alcrona Pro	DIN 6535HB

Workpiece material group suitability, starting values for cutting speed (m/min) and Alpha Code. Tables with feed per tooth and correction factors can be found starting from page 309.

P1.1	P1.2	P1.3	P2.1	P2.2	P2.3	P3.1	P3.2	P3.3	P4.1	P4.2	P4.3	M1.1	M1.2
■ 172 B	■ 193 B	■ 200 B	■ 148 B	■ 130 B	■ 115 B	■ 133 B	■ 107 B	■ 90 B	■ 79 B	■ 67 B	■ 55 B	■ 62 B	■ 52 B
M2.1	M2.2	M2.3	M3.1	M3.2	M3.3	M4.1	M4.2	K1.1	K1.2	K1.3	K2.1	K2.2	K2.3
■ 55 B	■ 45 B	■ 38 B	■ 47 A	■ 40 A	■ 36 A	■ 30 A	■ 26 A	■ 130 B	■ 96 B	■ 72 B	■ 123 B	■ 100 B	■ 80 B
K3.1	K3.2	K3.3	K4.1	K4.2	K4.3	K4.4	K4.5	K5.1	K5.2	K5.3	N1.1	N1.2	N1.3
■ 109 B	■ 83 B	■ 67 B	■ 101 A	■ 76 A	■ 56 A	■ 48 A	■ 40 A	■ 114 B	■ 86 B	■ 66 B	■ 400 C	■ 300 C	■ 200 C
N2.1	N2.2	N2.3	N3.1	N3.2	N3.3	N4.1	N4.2	N4.3	S1.1	S1.2	S1.3	S2.1	S2.2
■ 262 C	■ 235 C	■ 170 C	■ 610 C	■ 360 C	■ 180 C	■ 290 C	■ 145 C	■ 65 C	■ 40 A	■ 40 A	■ 30 A	■ 33 A	■ 25 A
S3.1	S3.2	S4.1	S4.2	H1.1									
■ 25 A	■ 21 A	■ 20 A	■ 16 A	■ 60 A									

Internal Thread.

7	TDZ	TP	DC	APMX	8	OAL	DCON MS	NOF	LU
		[mm]	[mm]	[mm]		[mm]	[mm]		[mm]
J2056.5X1.25	M8	1.25	6.50	17.50	72.0	10.00	3	19.10	
J2058.2X1.50	M10	1.50	8.20	21.00	83.0	12.00	3	22.80	
J2059.9X1.75	M12	1.75	9.90	26.25	83.0	14.00	4	28.20	
J20511.6X2.0	M14	2.00	11.60	30.00	92.0	16.00	4	32.20	
J20513.6X2.0	M16	2.00	13.60	34.00	92.0	18.00	4	36.20	



THREAD MILLS – PAGE OVERVIEW

Pos.	Description	Pos.	Description
1	Designation of thread mills	5	Product features
2	Product description	6	Material group recommendations incl. speed and feed guidance
3	Illustrative picture	7	Product code
4	Schematic drawing of tool	8	Product dimensions



THREAD MILLS – ICONS OVERVIEW

General Icons

	Primary use
	Possible use

Thread Form (THFT)

	Thread Form, British Standard Pipe		Thread Form, Metric Fine		Thread Form, Unified Coarse
	Thread Form, Metric Coarse		Thread Form, American National Pipe Taper		Thread Form, Unified Fine

Basic Standard Group (BSG)

	Dormer Standards
--	------------------

Usable Length (ULDR)

	1.5xD Usable Tool Depth to Diameter Ratio		2xD Usable Tool Depth to Diameter Ratio
--	---	--	---

Material Code (BMC)

	Hard Material (Solid Carbide)
--	-------------------------------

Flute Geometry (FDC)

	Spiral Flute Geometry
--	-----------------------

Flute Helix Angle (FHA)

	10° Helix Angle (Flute)		27° Helix Angle (Flute)
--	-------------------------	--	-------------------------

Hand (Cutting direction)

	Right Hand Rotation / Cutting
--	-------------------------------

Coating

	Aluminium Chromium Nitride (special optimized process)
--	--

Shank

	DIN 6535 HA Cylindrical Shank		DIN 6535 HB Weldon Shank
--	-------------------------------	--	--------------------------

Coolant Exit Style (CXSC)

	Through Tool Coolant – Axial Exit
--	-----------------------------------



THREAD MILLS – TOOL MATERIALS AND SURFACE COATINGS NAVIGATOR

HM materials

Carbide Materials (or Hard Materials)



HM

A sintered powder metallurgy substrate, consisting of a metallic carbide composite with binder metal. The most central raw material is tungsten carbide (WC). Tungsten carbide contributes to the hardness of the material. Tantalum carbide (TaC), titanium carbide (TiC) and niobium carbide (NbC) complements WC and adjusts the properties to what is desired. These three materials are called cubic carbides. Cobalt (Co) acts as a binder and keeps the material together.

Carbide materials are often characterised by high compression strength, high hardness and therefore high wear resistance, but also by limited flexural strength and toughness. Carbide is used in taps, reamers, milling cutters, drills and thread milling cutters.

Surface Coatings

Alcrona coatings (Alcrona Pro)



The Alcrona (AlCrN) family of coatings are aluminium chromium nitride coatings mostly used for milling cutters. The two unique properties of these coatings are high hot hardness and high oxidation resistance. When used on tools for machining applications involving heavy mechanical and thermal stresses, these properties translate into superior wear resistance. Multiple levels or specific versions of these coatings are available and specific for various tools and applications.



Thread form (THFT)	M	M	M	M	MF	MF	UNC	UNF	G	NPT			
Basic standard group (BSG)													
Usable length (ULDR)	2×D	2×D	2×D	2×D	1.5×D	1.5×D	2×D	2×D	1.5×D				
Material code (BMC)	HM	HM	HM	HM	HM	HM	HM	HM	HM	HM			
Flute Geometry (FDC)													
Flute helix angle (FHA)	λ 10°	λ 10°	λ 27°	λ 27°	λ 10°	λ 10°	λ 10°	λ 10°	λ 10°	λ 10°			
Hand (Cutting direction)													
Coating													
Shank													
Coolant exit style (CXSC)													
Product Family Code	J200	J205	J210	J215	J220	J225	J235	J245	J280	J260			
	M4 - M16	M8 - M16	M6 - M16	M6 - M16	M6 - M24	M10 - M18	1/4 - 3/4	1/4 - 3/4	1/8 - 3"	1/8 - 2"			
	299	300	301	302	303	304	305	306	307	308			
P	P1	■	■	■	■	■	■	■	■	■			
	P2	■	■	■	■	■	■	■	■	■			
	P3	■	■	■	■	■	■	■	■	■			
	P4	■	■	■	■	■	■	■	■	■			
M	M1	■	■	■	■	■	■	■	■	■			
	M2	■	■	■	■	■	■	■	■	■			
	M3	■	■	■	■	■	■	■	■	■			
	M4	▣	▣	■	■	▣	▣	■	■	■			
K	K1	■	■	■	■	■	■	■	■	■			
	K2	■	■	■	■	■	■	■	■	■			
	K3	■	■	■	■	■	■	■	■	■			
	K4	■	■	■	■	■	■	■	■	■			
	K5	■	■	■	■	■	■	■	■	■			
N	N1	■	■	■	■	■	■	■	■	■			
	N2	■	■	■	■	■	■	■	■	■			
	N3	■	■	■	■	■	■	■	■	■			
	N4	■	■	■	■	■	■	■	■	■			
	N5												
S	S1	▣	■	▣	■	▣	■	■	■	■			
	S2	▣	▣	▣	▣	▣	▣	▣	▣	▣			
	S3	▣	▣	▣	▣	▣	▣	▣	▣	▣			
	S4	▣	▣	▣	▣	▣	▣	▣	▣	▣			
H	H1	▣	▣	■	■	■	■	■	■	■			
	H2												
	H3			▣	▣	▣	▣	▣	▣	▣			
	H4												

■ Primary use ▣ Possible use



J200



Solid Carbide Thread Mill with Countersink, Metric

Universal high performance tool to machine same or bigger diameters than the TDZ with the same pitch. Left or right-hand, through or blind holes almost down to the bottom. With 60° countersink for chamfering in a single machining cycle. Alcrona Pro coated for the best machining result in a wide range of materials.

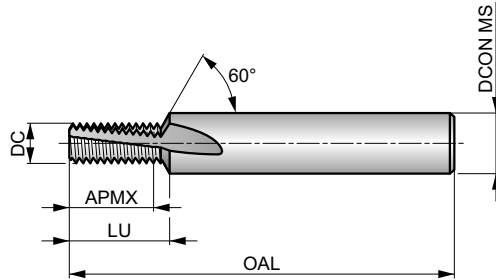

		2xD
HM		λ 10°
	Alcrona Pro	DIN 6535HA

Workpiece material group suitability, starting values for cutting speed (m/min) and Alpha Code. Tables with feed per tooth and correction factors can be found starting from page 309.

P1.1 ■ 172 B	P1.2 ■ 193 B	P1.3 ■ 200 B	P2.1 ■ 148 B	P2.2 ■ 130 B	P2.3 ■ 115 B	P3.1 ■ 133 B	P3.2 ■ 107 B	P3.3 ■ 90 B	P4.1 ■ 79 B	P4.2 ■ 67 B	P4.3 ▣ 55 B	M1.1 ■ 62 B	M1.2 ■ 52 B
M2.1 ■ 55 B	M2.2 ■ 45 B	M2.3 ▣ 38 B	M3.1 ■ 47 A	M3.2 ■ 40 A	M3.3 ▣ 36 A	M4.1 ■ 30 A	M4.2 ▣ 26 A	K1.1 ■ 130 B	K1.2 ■ 96 B	K1.3 ■ 72 B	K2.1 ■ 123 B	K2.2 ■ 100 B	K2.3 ■ 80 B
K3.1 ■ 109 B	K3.2 ■ 83 B	K3.3 ■ 67 B	K4.1 ■ 101 A	K4.2 ■ 76 A	K4.3 ■ 56 A	K4.4 ■ 48 A	K4.5 ▣ 40 A	K5.1 ■ 114 B	K5.2 ■ 86 B	K5.3 ■ 66 B	N1.1 ■ 400 C	N1.2 ■ 300 C	N1.3 ■ 200 C
N2.1 ■ 262 C	N2.2 ■ 235 C	N2.3 ■ 170 C	N3.1 ■ 610 C	N3.2 ■ 360 C	N3.3 ■ 180 C	N4.1 ■ 290 C	N4.2 ■ 145 C	N4.3 ■ 65 C	S1.1 ■ 40 A	S1.2 ▣ 40 A	S1.3 ▣ 30 A	S2.1 ▣ 33 A	S2.2 ▣ 25 A
S3.1 ▣ 25 A	S3.2 ▣ 21 A	S4.1 ▣ 20 A	S4.2 ▣ 16 A	H1.1 ▣ 60 A									

Internal Thread.

Product	TDZ	TP	DC	APMX	OAL	DCON MS	NOF	LU
		[mm]	[mm]	[mm]	[mm]	[mm]		[mm]
J2003.2X.7	M4	0.70	3.20	8.40	57.0	6.00	3	9.50
J2004.1X.8	M5	0.80	4.10	11.20	57.0	6.00	3	12.10
J2004.8X1.0	M6	1.00	4.80	13.00	63.0	8.00	3	14.40
J2006.5X1.25	M8	1.25	6.50	17.50	72.0	10.00	3	19.10
J2008.2X1.5	M10	1.50	8.20	21.00	83.0	12.00	3	22.80
J2009.9X1.75	M12	1.75	9.90	26.25	83.0	14.00	4	28.20
J20011.6X2.0	M14	2.00	11.60	30.00	92.0	16.00	4	32.20
J20013.6X2.0	M16	2.00	13.60	34.00	92.0	18.00	4	36.20



J205



Solid Carbide Thread Mill with Through Coolant and Countersink, Metric

Universal high performance tool to machine same or bigger diameters than the TDZ with the same pitch. Left or right-hand, through or blind holes almost down to the bottom. With 60° countersink for chamfering. Alcrona Pro coated for the best machining result with through coolant for better chip evacuation.

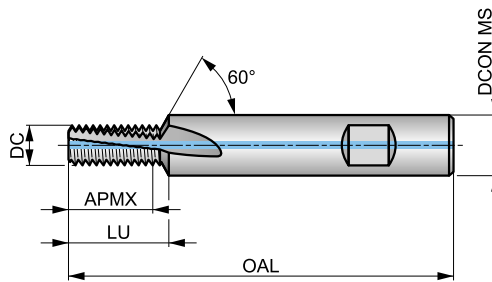

		2xD
HM		λ 10°
	Alcrona Pro	

Workpiece material group suitability, starting values for cutting speed (m/min) and Alpha Code. Tables with feed per tooth and correction factors can be found starting from page 309.

P1.1 ■ 172 B	P1.2 ■ 193 B	P1.3 ■ 200 B	P2.1 ■ 148 B	P2.2 ■ 130 B	P2.3 ■ 115 B	P3.1 ■ 133 B	P3.2 ■ 107 B	P3.3 ■ 90 B	P4.1 ■ 79 B	P4.2 ■ 67 B	P4.3 ■ 55 B	M1.1 ■ 62 B	M1.2 ■ 52 B
M2.1 ■ 55 B	M2.2 ■ 45 B	M2.3 ■ 38 B	M3.1 ■ 47 A	M3.2 ■ 40 A	M3.3 ■ 36 A	M4.1 ■ 30 A	M4.2 ■ 26 A	K1.1 ■ 130 B	K1.2 ■ 96 B	K1.3 ■ 72 B	K2.1 ■ 123 B	K2.2 ■ 100 B	K2.3 ■ 80 B
K3.1 ■ 109 B	K3.2 ■ 83 B	K3.3 ■ 67 B	K4.1 ■ 101 A	K4.2 ■ 76 A	K4.3 ■ 56 A	K4.4 ■ 48 A	K4.5 ■ 40 A	K5.1 ■ 114 B	K5.2 ■ 86 B	K5.3 ■ 66 B	N1.1 ■ 400 C	N1.2 ■ 300 C	N1.3 ■ 200 C
N2.1 ■ 262 C	N2.2 ■ 235 C	N2.3 ■ 170 C	N3.1 ■ 610 C	N3.2 ■ 360 C	N3.3 ■ 180 C	N4.1 ■ 290 C	N4.2 ■ 145 C	N4.3 ■ 65 C	S1.1 ■ 40 A	S1.2 ■ 40 A	S1.3 ■ 30 A	S2.1 ■ 33 A	S2.2 ■ 25 A
S3.1 ■ 25 A	S3.2 ■ 21 A	S4.1 ■ 20 A	S4.2 ■ 16 A	H1.1 ■ 60 A									

Internal Thread.

Product	TDZ	TP	DC	APMX	OAL	DCON MS	NOF	LU
		[mm]	[mm]	[mm]	[mm]	[mm]		[mm]
J2056.5X1.25	M8	1.25	6.50	17.50	72.0	10.00	3	19.10
J2058.2X1.50	M10	1.50	8.20	21.00	83.0	12.00	3	22.80
J2059.9X1.75	M12	1.75	9.90	26.25	83.0	14.00	4	28.20
J20511.6X2.0	M14	2.00	11.60	30.00	92.0	16.00	4	32.20
J20513.6X2.0	M16	2.00	13.60	34.00	92.0	18.00	4	36.20



J210



Solid Carbide Thread Mill with High Helix, Metric

Universal high performance tool to machine same or bigger diameters than the TDZ with the same pitch. Left or right-hand, through or blind holes almost down to the bottom. With Alcrona Pro coated for the best machining result in a wide range of materials and 27° helix for a smoother cutting action.

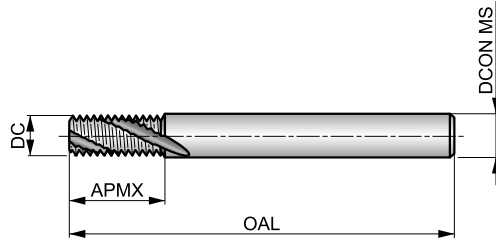

		2xD
HM		λ 27°
	Alcrona Pro	DIN 6535HA

Workpiece material group suitability, starting values for cutting speed (m/min) and Alpha Code. Tables with feed per tooth and correction factors can be found starting from page 309.

P1.1 ■ 181 B	P1.2 ■ 203 B	P1.3 ■ 210 B	P2.1 ■ 156 B	P2.2 ■ 137 B	P2.3 ■ 121 B	P3.1 ■ 140 B	P3.2 ■ 112 B	P3.3 ■ 95 B	P4.1 ■ 83 B	P4.2 ■ 70 B	P4.3 ▣ 58 B	M1.1 ■ 65 B	M1.2 ■ 55 B
M2.1 ■ 58 B	M2.2 ■ 47 B	M2.3 ▣ 40 B	M3.1 ■ 50 A	M3.2 ■ 42 A	M3.3 ▣ 38 A	M4.1 ■ 32 A	M4.2 ▣ 27 A	K1.1 ■ 137 B	K1.2 ■ 101 B	K1.3 ■ 76 B	K2.1 ■ 129 B	K2.2 ■ 105 B	K2.3 ■ 84 B
K3.1 ■ 115 B	K3.2 ■ 87 B	K3.3 ■ 71 B	K4.1 ■ 106 A	K4.2 ■ 80 A	K4.3 ■ 59 A	K4.4 ■ 51 A	K4.5 ▣ 42 A	K5.1 ■ 120 B	K5.2 ■ 90 B	K5.3 ■ 70 B	N1.1 ■ 420 C	N1.2 ■ 315 C	N1.3 ■ 210 C
N2.1 ■ 275 C	N2.2 ■ 247 C	N2.3 ■ 179 C	N3.1 ■ 640 C	N3.2 ■ 378 C	N3.3 ■ 189 C	N4.1 ■ 305 C	N4.2 ■ 153 C	N4.3 ■ 69 C	S1.1 ■ 42 A	S1.2 ▣ 42 A	S1.3 ▣ 32 A	S2.1 ▣ 35 A	S2.2 ▣ 26 A
S3.1 ▣ 26 A	S3.2 ▣ 22 A	S4.1 ▣ 21 A	S4.2 ▣ 17 A	H1.1 ■ 63 A	H3.1 ▣ 45 A								

Internal Thread.

Product	TDZ	TP	DC	APMX	OAL	DCON MS	NOF
		[mm]	[mm]	[mm]	[mm]	[mm]	
J2104.5X1.0	M6	1.00	4.50	13.00	57.0	6.00	3
J2106.0X1.25	M8	1.25	6.00	17.50	65.0	6.00	3
J2107.5X1.5	M10	1.50	7.50	21.00	72.0	8.00	3
J2109.5X1.75	M12	1.75	9.50	26.25	80.0	10.00	3
J21010.0X2.0	M14	2.00	10.00	30.00	83.0	10.00	4
J21012.0X2.0	M16	2.00	12.00	34.00	92.0	12.00	4



J215



Solid Carbide Thread Mill with High Helix and Through Coolant, Metric

Universal high performance tool to machine same or bigger diameters than the TDZ with the same pitch. Left or right-hand, through or blind holes almost down to the bottom. Alcrona Pro coated for the best machining result with through coolant for better chip evacuation and 27° helix for a smoother cutting action.

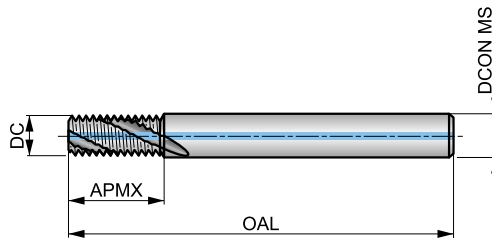

		2xD
HM		λ 27°
	Alcrona Pro	DIN 6535HA

Workpiece material group suitability, starting values for cutting speed (m/min) and Alpha Code. Tables with feed per tooth and correction factors can be found starting from page 309.

P1.1 ■ 181 B	P1.2 ■ 203 B	P1.3 ■ 210 B	P2.1 ■ 156 B	P2.2 ■ 137 B	P2.3 ■ 121 B	P3.1 ■ 140 B	P3.2 ■ 112 B	P3.3 ■ 95 B	P4.1 ■ 83 B	P4.2 ■ 70 B	P4.3 ■ 58 B	M1.1 ■ 65 B	M1.2 ■ 55 B
M2.1 ■ 58 B	M2.2 ■ 47 B	M2.3 ■ 40 B	M3.1 ■ 50 A	M3.2 ■ 42 A	M3.3 ■ 38 A	M4.1 ■ 32 A	M4.2 □ 27 A	K1.1 ■ 137 B	K1.2 ■ 101 B	K1.3 ■ 76 B	K2.1 ■ 129 B	K2.2 ■ 105 B	K2.3 ■ 84 B
K3.1 ■ 115 B	K3.2 ■ 87 B	K3.3 ■ 71 B	K4.1 ■ 106 A	K4.2 ■ 80 A	K4.3 ■ 59 A	K4.4 ■ 51 A	K4.5 ■ 42 A	K5.1 ■ 120 B	K5.2 ■ 90 B	K5.3 ■ 70 B	N1.1 ■ 420 C	N1.2 ■ 315 C	N1.3 ■ 210 C
N2.1 ■ 275 C	N2.2 ■ 247 C	N2.3 ■ 179 C	N3.1 ■ 640 C	N3.2 ■ 378 C	N3.3 ■ 189 C	N4.1 ■ 305 C	N4.2 ■ 153 C	N4.3 ■ 69 C	S1.1 ■ 42 A	S1.2 ■ 42 A	S1.3 □ 32 A	S2.1 ■ 35 A	S2.2 □ 26 A
S3.1 ■ 26 A	S3.2 □ 22 A	S4.1 ■ 21 A	S4.2 □ 17 A	H1.1 ■ 63 A	H3.1 □ 45 A								

Internal Thread.

Product	TDZ	TP	DC	APMX	OAL	DCON MS	NOF
		[mm]	[mm]	[mm]	[mm]	[mm]	
J2154.5X1.0	M6	1.00	4.50	13.00	57.0	6.00	3
J2156.0X1.25	M8	1.25	6.00	17.50	65.0	6.00	3
J2157.5X1.5	M10	1.50	7.50	21.00	72.0	8.00	3
J2159.5X1.75	M12	1.75	9.50	26.25	80.0	10.00	3
J21510.0X2.0	M14	2.00	10.00	30.00	83.0	10.00	4
J21512.0X2.0	M16	2.00	12.00	34.00	92.0	12.00	4



J220



Solid Carbide Thread Mill, Metric Fine

Universal high performance tool to machine same or bigger diameters than the TDZ with the same pitch. Left or right-hand, through or blind holes almost down to the bottom. Alcrona Pro coated for the best machining result in a wide range of materials.

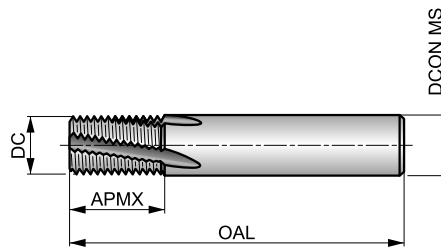

		1.5×D
HM		λ 10°
	Alcrona Pro	DIN 6535HA

Workpiece material group suitability, starting values for cutting speed (m/min) and Alpha Code. Tables with feed per tooth and correction factors can be found starting from page 309.

P1.1 ■ 190 E	P1.2 ■ 212 E	P1.3 ■ 242 E	P2.1 ■ 163 E	P2.2 ■ 143 E	P2.3 ■ 127 E	P3.1 ■ 146 E	P3.2 ■ 118 E	P3.3 ■ 99 E	P4.1 ■ 87 E	P4.2 ■ 74 E	P4.3 ■ 61 E	M1.1 ■ 69 E	M1.2 ■ 58 E
M2.1 ■ 61 E	M2.2 ■ 50 E	M2.3 ▣ 42 E	M3.1 ■ 52 D	M3.2 ■ 44 D	M3.3 ▣ 40 D	M4.1 ■ 33 D	M4.2 ▣ 29 D	K1.1 ■ 143 E	K1.2 ■ 106 E	K1.3 ■ 80 E	K2.1 ■ 136 E	K2.2 ■ 110 E	K2.3 ■ 88 E
K3.1 ■ 120 E	K3.2 ■ 91 E	K3.3 ■ 74 E	K4.1 ■ 111 D	K4.2 ■ 84 D	K4.3 ■ 62 D	K4.4 ■ 53 D	K4.5 ▣ 44 D	K5.1 ■ 126 E	K5.2 ■ 95 E	K5.3 ■ 73 E	N1.1 ■ 440 F	N1.2 ■ 330 F	N1.3 ■ 220 F
N2.1 ■ 288 F	N2.2 ■ 259 F	N2.3 ■ 187 F	N3.1 ■ 671 F	N3.2 ■ 396 F	N3.3 ■ 198 F	N4.1 ■ 319 F	N4.2 ■ 160 F	N4.3 ■ 72 F	S1.1 ■ 44 D	S1.2 ▣ 44 D	S1.3 ▣ 33 D	S2.1 ▣ 36 D	S2.2 ▣ 28 D
S3.1 ▣ 28 D	S3.2 ▣ 23 D	S4.1 ▣ 22 D	S4.2 ▣ 18 D	H1.1 ■ 66 D	H3.1 ▣ 48 D								

Internal Thread.

Product	TDZ	TP	DC	APMX	OAL	DCON MS	NOF
		[mm]	[mm]	[mm]	[mm]	[mm]	
J2204.8X.5	M6	0.50	4.80	10.00	57.0	6.00	3
J2206.0X.75	M8	0.75	6.00	12.00	57.0	6.00	3
J2206.0X1.0	M8	1.00	6.00	12.00	57.0	6.00	3
J2208.0X1.0	M10	1.00	8.00	16.00	63.0	8.00	4
J22010.0X1.0	M12	1.00	10.00	20.00	72.0	10.00	4
J22010.0X1.5	M12	1.50	10.00	20.00	72.0	10.00	4
J22012.0X1.0	M14	1.00	12.00	22.00	83.0	12.00	4
J22012.0X1.5	M14	1.50	12.00	22.00	83.0	12.00	4
J22014.0X1.0	M16	1.00	14.00	26.00	83.0	14.00	5
J22014.0X1.5	M16	1.50	14.00	26.00	83.0	14.00	5
J22016.0X2.0	M20	2.00	16.00	30.00	92.0	16.00	5
J22016.0X2.5	M20	2.50	16.00	42.50	105.0	16.00	5
J22019.0X3.0	M24	3.00	19.00	50.00	125.0	20.00	5
J22020.0X2.0	M24	2.00	20.00	35.00	104.0	20.00	5



J225



Solid Carbide Thread Mill with Through Coolant, Metric Fine

Universal high performance tool to machine same or bigger diameters than the TDZ with the same pitch. Left or right-hand, through or blind holes almost down to the bottom. With Alcrona Pro coated for the best machining result and through coolant for better chip evacuation.

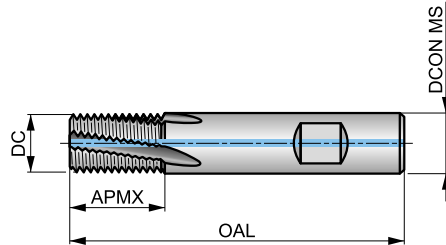

		1.5×D
HM		λ 10°
	Alcrona Pro	DIN 6535HB

Workpiece material group suitability, starting values for cutting speed (m/min) and Alpha Code. Tables with feed per tooth and correction factors can be found starting from page 309.

P1.1 ■ 190 E	P1.2 ■ 212 E	P1.3 ■ 242 E	P2.1 ■ 163 E	P2.2 ■ 143 E	P2.3 ■ 127 E	P3.1 ■ 146 E	P3.2 ■ 118 E	P3.3 ■ 99 E	P4.1 ■ 87 E	P4.2 ■ 74 E	P4.3 ■ 61 E	M1.1 ■ 69 E	M1.2 ■ 58 E
M2.1 ■ 61 E	M2.2 ■ 50 E	M2.3 ■ 42 E	M3.1 ■ 52 D	M3.2 ■ 44 D	M3.3 ■ 40 D	M4.1 ■ 33 D	M4.2 □ 29 D	K1.1 ■ 143 E	K1.2 ■ 106 E	K1.3 ■ 80 E	K2.1 ■ 136 E	K2.2 ■ 110 E	K2.3 ■ 88 E
K3.1 ■ 120 E	K3.2 ■ 91 E	K3.3 ■ 74 E	K4.1 ■ 111 D	K4.2 ■ 84 D	K4.3 ■ 62 D	K4.4 ■ 53 D	K4.5 ■ 44 D	K5.1 ■ 126 E	K5.2 ■ 95 E	K5.3 ■ 73 E	N1.1 ■ 440 F	N1.2 ■ 330 F	N1.3 ■ 220 F
N2.1 ■ 288 F	N2.2 ■ 259 F	N2.3 ■ 187 F	N3.1 ■ 671 F	N3.2 ■ 396 F	N3.3 ■ 198 F	N4.1 ■ 319 F	N4.2 ■ 160 F	N4.3 ■ 72 F	S1.1 ■ 44 D	S1.2 ■ 44 D	S1.3 □ 33 D	S2.1 ■ 36 D	S2.2 □ 28 D
S3.1 ■ 28 D	S3.2 □ 23 D	S4.1 ■ 22 D	S4.2 □ 18 D	H1.1 ■ 66 D	H3.1 □ 48 D								

Internal Thread.

Product	TDZ	TP	DC	APMX	OAL	DCON MS	NOF
		[mm]	[mm]	[mm]	[mm]	[mm]	
J2258.0X1.0	M10	1.00	8.00	16.00	63.0	8.00	4
J22510.0X1.0	M12	1.00	10.00	20.00	72.0	10.00	4
J22510.0X1.5	M12	1.50	10.00	20.00	72.0	10.00	4
J22512.0X1.0	M14	1.00	12.00	22.00	83.0	12.00	4
J22512.0X1.5	M14	1.50	12.00	22.00	83.0	12.00	4
J22514.0X1.0	M16	1.00	14.00	26.00	83.0	14.00	5
J22514.0X1.5	M16	1.50	14.00	26.00	83.0	14.00	5
J22516.0X1.5	M18	1.50	16.00	30.00	92.0	16.00	5



J235



Solid Carbide Thread Mill with Through Coolant, UNC

Universal high performance tool to machine same or bigger diameters than the TDZ with the same pitch. Left or right-hand, through or blind holes almost down to the bottom. With Alcrona Pro coated for the best machining result and through coolant for better chip evacuation.

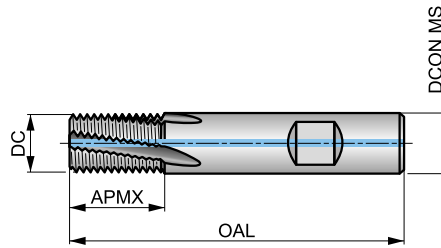

Workpiece material group suitability, starting values for cutting speed (m/min) and Alpha Code. Tables with feed per tooth and correction factors can be found starting from page 309.

P1.1 ■ 181 H	P1.2 ■ 203 H	P1.3 ■ 210 H	P2.1 ■ 156 H	P2.2 ■ 137 H	P2.3 ■ 121 H	P3.1 ■ 140 H	P3.2 ■ 112 H	P3.3 ■ 95 H	P4.1 ■ 83 H	P4.2 ■ 70 H	P4.3 ■ 58 H	M1.1 ■ 65 H	M1.2 ■ 55 H
M2.1 ■ 58 H	M2.2 ■ 47 H	M2.3 ■ 40 H	M3.1 ■ 50 G	M3.2 ■ 42 G	M3.3 ■ 38 G	M4.1 ■ 32 G	M4.2 ▣ 127 G	K1.1 ■ 137 H	K1.2 ■ 101 H	K1.3 ■ 76 H	K2.1 ■ 129 H	K2.2 ■ 105 H	K2.3 ■ 84 H
K3.1 ■ 115 H	K3.2 ■ 87 H	K3.3 ■ 71 H	K4.1 ■ 106 G	K4.2 ■ 80 G	K4.3 ■ 59 G	K4.4 ■ 51 G	K4.5 ■ 42 G	K5.1 ■ 120 H	K5.2 ■ 90 H	K5.3 ■ 70 H	N1.1 ■ 420 I	N1.2 ■ 315 I	N1.3 ■ 210 I
N2.1 ■ 275 I	N2.2 ■ 247 I	N2.3 ■ 179 I	N3.1 ■ 640 I	N3.2 ■ 378 I	N3.3 ■ 189 I	N4.1 ■ 305 I	N4.2 ■ 153 I	N4.3 ■ 69 I	S1.1 ■ 42 G	S1.2 ■ 42 G	S1.3 ▣ 32 G	S2.1 ■ 35 G	S2.2 ▣ 26 G
S3.1 ■ 26 G	S3.2 ▣ 22 G	S4.1 ■ 21 G	S4.2 ▣ 17 G	H1.1 ■ 63 G	H3.1 ▣ 45 G								

Internal Thread.

Product	TDZ	TPI	DC	APMX	OAL	DCON MS	NOF
			[mm]	[mm]	[mm]	[mm]	
J2354.8-20	1/4	20	4.80	14.00	57.0	6.00	3
J2355.5-18	5/16	18	5.50	14.00	57.0	6.00	3
J2357.5-16	3/8	16	7.50	19.00	63.0	8.00	4
J2358.0-14	7/16	14	8.00	19.00	63.0	8.00	4
J23510.0-13	1/2	13	10.00	22.00	72.0	10.00	4
J23510.0-12	9/16	12	10.00	22.00	72.0	10.00	4
J23512.0-11	5/8	11	12.00	26.00	83.0	12.00	4
J23514.0-10	3/4	10	14.00	32.00	83.0	14.00	5



J245



Solid Carbide Thread Mill with Through Coolant, UNF

Universal high performance tool to machine same or bigger diameters than the TDZ with the same pitch. Left or right-hand, through or blind holes almost down to the bottom. With Alcrona Pro coated for the best machining result and through coolant for better chip evacuation.

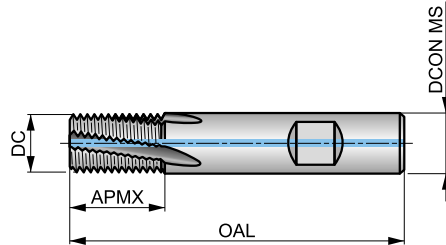

Workpiece material group suitability, starting values for cutting speed (m/min) and Alpha Code. Tables with feed per tooth and correction factors can be found starting from page XY.

P1.1 ■ 181 K	P1.2 ■ 203 K	P1.3 ■ 210 K	P2.1 ■ 156 K	P2.2 ■ 137 K	P2.3 ■ 121 K	P3.1 ■ 140 K	P3.2 ■ 112 K	P3.3 ■ 95 K	P4.1 ■ 83 K	P4.2 ■ 70 K	P4.3 ■ 58 K	M1.1 ■ 65 K	M1.2 ■ 55 K
M2.1 ■ 58 K	M2.2 ■ 47 K	M2.3 ■ 40 K	M3.1 ■ 50 J	M3.2 ■ 42 J	M3.3 ■ 38 J	M4.1 ■ 32 J	M4.2 □ 27 J	K1.1 ■ 137 K	K1.2 ■ 101 K	K1.3 ■ 76 K	K2.1 ■ 129 K	K2.2 ■ 105 K	K2.3 ■ 84 K
K3.1 ■ 115 K	K3.2 ■ 87 K	K3.3 ■ 71 K	K4.1 ■ 106 J	K4.2 ■ 80 J	K4.3 ■ 59 J	K4.4 ■ 51 J	K4.5 ■ 42 J	K5.1 ■ 120 K	K5.2 ■ 90 K	K5.3 ■ 70 K	N1.1 ■ 420 L	N1.2 ■ 315 L	N1.3 ■ 210 L
N2.1 ■ 275 L	N2.2 ■ 247 L	N2.3 ■ 179 L	N3.1 ■ 640 L	N3.2 ■ 378 L	N3.3 ■ 189 L	N4.1 ■ 305 L	N4.2 ■ 153 L	N4.3 ■ 69 L	S1.1 ■ 42 J	S1.2 ■ 42 J	S1.3 □ 32 J	S2.1 ■ 35 J	S2.2 □ 26 J
S3.1 ■ 26 J	S3.2 □ 22 J	S4.1 ■ 21 J	S4.2 □ 17 J	H1.1 ■ 63 J	H3.1 □ 45 J								

Internal Thread.

Product	TDZ	TPI	DC	APMX	OAL	DCON MS	NOF
			[mm]	[mm]	[mm]	[mm]	
J2454.8-28	1/4	28	4.80	14.00	57.0	6.00	3
J2456.0-24	5/16. 3/8	24	6.00	14.00	57.0	6.00	3
J2458.0-20	7/16. 1/2	20	8.00	19.00	63.0	8.00	4
J24510.0-18	9/16. 5/8	18	10.00	22.00	72.0	10.00	4
J24514.0-16	3/4	16	14.00	32.00	83.0	14.00	5



J280



Solid Carbide Thread Mill, G(BSP)

Universal high performance tool to machine same or bigger diameters than the TDZ with the same pitch. Left or right-hand, through or blind holes almost down to the bottom. Alcrona Pro coated for the best machining result in a wide range of materials. Suited for producing internal and external threads.

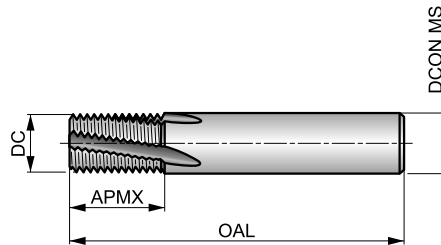

		1.5×D
HM		λ 10°
	Alcrona Pro	

Workpiece material group suitability, starting values for cutting speed (m/min) and Alpha Code. Tables with feed per tooth and correction factors can be found starting from page 309.

P1.1 ■ 190 N	P1.2 ■ 212 N	P1.3 ■ 242 N	P2.1 ■ 163 N	P2.2 ■ 143 N	P2.3 ■ 127 N	P3.1 ■ 146 N	P3.2 ■ 118 N	P3.3 ■ 99 N	P4.1 ■ 87 N	P4.2 ■ 74 N	P4.3 ■ 61 N	M1.1 ■ 69 N	M1.2 ■ 58 N
M2.1 ■ 61 N	M2.2 ■ 50 N	M2.3 ■ 42 N	M3.1 ■ 52 M	M3.2 ■ 44 M	M3.3 ■ 40 M	M4.1 ■ 33 M	M4.2 ▣ 29 M	K1.1 ■ 143 N	K1.2 ■ 106 N	K1.3 ■ 80 N	K2.1 ■ 136 N	K2.2 ■ 110 N	K2.3 ■ 88 N
K3.1 ■ 120 N	K3.2 ■ 91 N	K3.3 ■ 74 N	K4.1 ■ 111 M	K4.2 ■ 84 M	K4.3 ■ 62 M	K4.4 ■ 53 M	K4.5 ■ 44 M	K5.1 ■ 126 N	K5.2 ■ 95 N	K5.3 ■ 76 N	N1.1 ■ 440 O	N1.2 ■ 330 O	N1.3 ■ 220 O
N2.1 ■ 288 O	N2.2 ■ 259 O	N2.3 ■ 187 O	N3.1 ■ 671 O	N3.2 ■ 396 O	N3.3 ■ 198 O	N4.1 ■ 319 O	N4.2 ■ 160 O	N4.3 ■ 72 O	S1.1 ■ 44 M	S1.2 ■ 44 M	S1.3 ▣ 33 M	S2.1 ■ 36 M	S2.2 ▣ 28 M
S3.1 ■ 28 M	S3.2 ▣ 23 M	S4.1 ■ 22 M	S4.2 ▣ 18 M	H1.1 ■ 66 M	H3.1 ▣ 48 M								

Internal and External Thread.

Product	TDZ	TPI	DC	APMX	OAL	DCON MS	NOF
			[mm]	[mm]	[mm]	[mm]	
J2806.0-28	1/8	28	6.00	15.00	57.0	6.00	3
J28010.0-19	1/4	19	10.00	20.00	72.0	10.00	4
J28014.0-19	3/8	19	14.00	26.00	83.0	14.00	5
J28016.0-14	1/2, 5/8	14	16.00	30.00	92.0	16.00	5
J28020.0-14	5/8, 3/4, 7/8	14	20.00	35.00	104.0	20.00	5
J28025.0-11	1" 3"	11	25.00	45.00	121.0	25.00	6



J260



Solid Carbide Thread Mill, NPT

Universal high performance tool to machine same or bigger diameters than the TDZ with the same pitch. Left or right-hand, through or blind holes almost down to the bottom. Alcrona Pro coated for the best machining result in a wide range of materials.

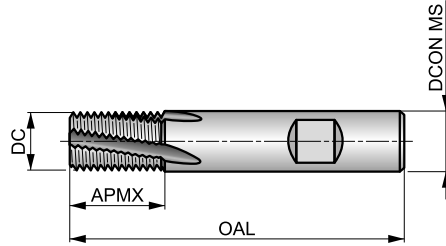

	λ 10°	

Workpiece material group suitability, starting values for cutting speed (m/min) and Alpha Code. Tables with feed per tooth and correction factors can be found starting from page 309.

P1.1 ■ 190 R	P1.2 ■ 212 R	P1.3 ■ 242 R	P2.1 ■ 163 R	P2.2 ■ 143 R	P2.3 ■ 127 R	P3.1 ■ 146 R	P3.2 ■ 118 R	P3.3 ■ 99 R	P4.1 ■ 87 R	P4.2 ■ 74 R	P4.3 ■ 61 R	M1.1 ■ 69 R	M1.2 ■ 58 R
M2.1 ■ 61 R	M2.2 ■ 50 R	M2.3 ■ 42 R	M3.1 ■ 52 Q	M3.2 ■ 44 Q	M3.3 ■ 40 Q	M4.1 ■ 33 Q	M4.2 □ 29 Q	K1.1 ■ 143 R	K1.2 ■ 106 R	K1.3 ■ 80 R	K2.1 ■ 136 R	K2.2 ■ 110 R	K2.3 ■ 88 R
K3.1 ■ 120 R	K3.2 ■ 91 R	K3.3 ■ 74 R	K4.1 ■ 111 Q	K4.2 ■ 84 Q	K4.3 ■ 62 Q	K4.4 ■ 53 Q	K4.5 ■ 44 Q	K5.1 ■ 126 R	K5.2 ■ 95 R	K5.3 ■ 73 R	N1.1 ■ 440 S	N1.2 ■ 330 S	N1.3 ■ 220 S
N2.1 ■ 288 S	N2.2 ■ 259 S	N2.3 ■ 187 S	N3.1 ■ 671 S	N3.2 ■ 396 S	N3.3 ■ 198 S	N4.1 ■ 319 S	N4.2 ■ 160 S	N4.3 ■ 72 S	S1.1 ■ 44 Q	S1.2 ■ 44 Q	S1.3 □ 33 Q	S2.1 ■ 36 Q	S2.2 □ 28 Q
S3.1 ■ 28 Q	S3.2 □ 23 Q	S4.1 ■ 22 Q	S4.2 □ 18 Q	H1.1 ■ 66 Q	H3.1 □ 48 Q								

Internal Thread.

Product	TDZ	TPI	DC	APMX	OAL	DCON MS	NOF
			[mm]	[mm]	[mm]	[mm]	
J2607.9-27	1/8	27	7.90	11.50	58.0	8.00	3
J2609.9-18	1/4. 3/8	18	9.90	15.92	66.0	10.00	3
J26015.9-14	1/2. 3/4	14	15.90	20.46	82.0	16.00	4
J26019.9-11.5	1". 2"	11.5	19.90	27.12	92.0	20.00	5



THREAD MILLS – FEED PER TOOTH TABLE

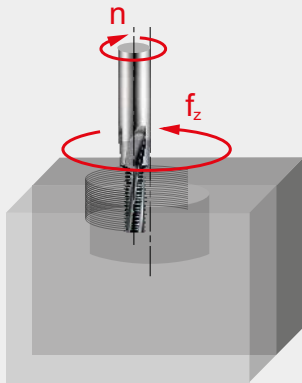

Feed per tooth per revolution (f_z in mm/rev).

The specified values are the recommended starting values for machining the full thread depth in one pass.

How to use this table to find the feed per tooth (f_z):

1. Find your Alpha Code on the product page (example: 181B, "B" is the Alpha Code).
2. Select the column matching your cutter diameter in the top row of the table with the Thread pitch P or TPI (in the rows with icons on the left).
3. Find your Alpha Code in the left column of the table.
4. The intersection (cell) of the Diameter + Pitch column and Alpha Code is the feed per tooth (f_z).

Correction of the feed per tooth for multiple passes:

5. In case the thread is being machined in **2 passes** the feed values mentioned in the table should be increased by **30 to 40%**.
6. In case the thread is being machined in **3 passes** the feed values mentioned in the table should be increased by **55 to 65%**.
7. In case the thread is being machined in **4 passes** the feed values mentioned in the table should be increased by **80 to 90%**.

(Example: J2003.2X.7 machining WMG M4.1 with feed rate A in 4-passes the $f_z = 0.017 \times 1.80 = 0.031$ mm/z).

		\varnothing DC [mm]																											
		3.20	4.10	4.50	4.80	5.50	6.00	6.50	7.50	7.90	8.00	8.20	9.50	9.90	10.00	11.60	12.00	13.60	14.00	16.00	19.00	20.00	25.00						
Feed rates		0.70	0.80	1.00	1.00	1.25	1.25	1.50	1.50	1.75	1.75	2.00	2.50	2.00	2.00														
	A	0.017	0.022	0.023	0.024	–	0.024	–	0.029	0.036	–	–	0.040	0.044	0.047	0.053	–	0.056	0.068	–	0.071	–	–	–	–				
	B	0.022	0.029	0.031	0.032	–	0.032	–	0.038	0.048	–	–	0.053	0.059	0.063	0.070	–	0.075	0.090	–	0.095	–	–	–	–				
	C	0.028	0.036	0.039	0.040	–	0.040	–	0.048	0.060	–	–	0.066	0.074	0.079	0.088	–	0.094	0.113	–	0.119	–	–	–	–				
				0.50	0.75	1.00	1.00	1.00	1.00	1.50	1.50	1.50	1.50	1.50	1.50	1.50	1.50	1.50	1.50	1.50	1.50	1.50	1.50	1.50	1.50				
	D	–	–	–	0.044	–	0.041	0.036	–	–	–	0.057	–	–	–	0.075	0.067	0.079	0.071	–	0.083	0.071	0.092	0.081	0.073	0.067	0.096	–	
	E	–	–	–	0.058	–	0.055	0.048	–	–	–	0.076	–	–	–	0.100	0.089	–	0.105	0.094	–	0.110	0.095	0.122	0.108	0.097	0.089	0.128	–
	F	–	–	–	0.073	–	0.069	0.060	–	–	–	0.095	–	–	–	0.125	0.111	–	0.131	0.118	–	0.138	0.119	0.153	0.135	0.121	0.111	0.160	–
					20	18	16	14	13	12	11	10																	
	G	–	–	–	0.019	0.023	–	–	–	0.030	–	0.034	–	–	–	0.053	0.051	–	0.055	–	–	0.066	–	–	–	–	–	–	–
	H	–	–	–	0.025	0.030	–	–	–	0.040	–	0.045	–	–	–	0.071	0.068	–	0.073	–	–	0.088	–	–	–	–	–	–	–
	I	–	–	–	0.031	0.038	–	–	–	0.050	–	0.056	–	–	–	0.089	0.085	–	0.091	–	–	0.110	–	–	–	–	–	–	–
					28	24	20	18	16																				
	J	–	–	–	0.023	–	0.026	–	–	–	–	0.041	–	–	–	0.062	–	–	–	–	–	0.083	–	–	–	–	–	–	–
	K	–	–	–	0.030	–	0.035	–	–	–	–	0.054	–	–	–	0.083	–	–	–	–	–	0.110	–	–	–	–	–	–	–
L	–	–	–	0.038	–	0.044	–	–	–	–	0.068	–	–	–	0.104	–	–	–	–	–	0.138	–	–	–	–	–	–	–	
				28																									
M	–	–	–	–	–	0.029	–	–	–	–	–	–	–	–	0.064	–	–	–	–	–	0.080	–	0.083	–	–	–	–	0.116	0.131
N	–	–	–	–	–	0.038	–	–	–	–	–	–	–	–	0.085	–	–	–	–	–	0.106	–	0.111	–	–	–	–	0.155	0.175
O	–	–	–	–	–	0.048	–	–	–	–	–	–	–	–	0.106	–	–	–	–	–	0.133	–	0.139	–	–	–	–	0.194	0.219
Q	–	–	–	–	–	–	–	–	–	–	0.039	–	–	–	0.044	–	–	–	–	–	–	–	–	–	–	–	–	–	–
R	–	–	–	–	–	–	–	–	–	–	0.052	–	–	–	0.059	–	–	–	–	–	–	–	–	–	–	–	–	–	–
S	–	–	–	–	–	–	–	–	–	–	0.065	–	–	–	0.074	–	–	–	–	–	–	–	–	–	–	–	–	–	–



THREAD MILLS – NUMBER OF PASSES TABLE

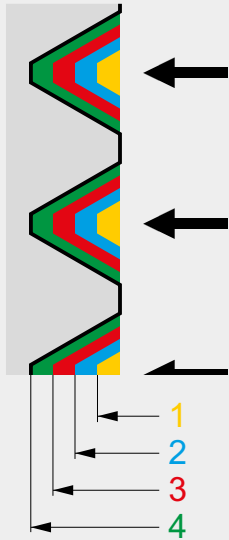

How to use the tables to find the depth increments per pass:

1. Select the table for your thread profile (example: "M12" is a metric thread).
2. Find the column matching your thread pitch in the top row of the table.
3. Find in that column below the recommended number of passes and for each pass the increment radial depth of cut. (example: for a pitch of 1.75 the recommended number of passes is 5 and radial depth of the 1st pass is 0.277 mm, the 2nd 0.228 mm etc.).
4. It is recommended to increase the number of passes for more difficult to machine materials.
5. For super-finishing result it is best practice to repeat the final pass.

Recommended number of passes and radial depth of cut per pass for female metric thread (60°).

		Radial depth of cut per pass [mm]										
		0.50	0.70	0.75	0.80	1.00	1.25	1.50	1.75	2.00	2.50	3.00
No. of passes	1	0.158	0.221	0.168	0.224	0.224	0.228	0.237	0.277	0.283	0.323	0.387
	2	0.131	0.183	0.138	0.185	0.185	0.188	0.196	0.228	0.234	0.267	0.320
	3	–	–	0.127	0.135	0.168	0.173	0.179	0.209	0.214	0.244	0.293
	4	–	–	–	–	–	0.133	0.138	0.161	0.164	0.187	0.225
	5	–	–	–	–	–	–	0.116	0.135	0.138	0.158	0.189
	6	–	–	–	–	–	–	–	–	0.122	0.139	0.167
	7	–	–	–	–	–	–	–	–	–	0.125	0.151
Acc. depth		0.289	0.404	0.433	0.544	0.577	0.722	0.866	1.010	1.155	1.443	1.732

Recommended number of passes and radial depth of cut per pass for female unified thread (60°).

		Radial depth of cut per pass [mm]									
		28	24	20	18	16	14	13	12	11	10
No. of passes	1	0.203	0.237	0.232	0.258	0.251	0.287	0.309	0.299	0.327	0.328
	2	0.167	0.195	0.191	0.213	0.207	0.237	0.255	0.247	0.270	0.271
	3	0.154	0.179	0.175	0.195	0.190	0.217	0.234	0.226	0.247	0.248
	4	–	–	0.135	0.149	0.146	0.166	0.179	0.174	0.189	0.190
	5	–	–	–	–	0.123	0.140	0.151	0.146	0.160	0.160
	6	–	–	–	–	–	–	–	0.130	0.140	0.141
	7	–	–	–	–	–	–	–	–	–	0.128
Acc. Depth		0.524	0.611	0.733	0.815	0.917	1.047	1.128	1.222	1.333	1.466



THREAD MILLS – NUMBER OF PASSES TABLE

Recommended number of passes and radial depth of cut per pass for female BSP thread (55°).

		Radial depth of cut per pass [mm]			
		28	19	14	11
No. of passes	1	0.225	0.271	0.318	0.362
	2	0.186	0.224	0.263	0.299
	3	0.170	0.205	0.241	0.274
	4	–	0.156	0.185	0.210
	5	–	–	0.155	0.177
	6	–	–	–	0.157
	7	–	–	–	–
Acc. Depth		0.581	0.856	1.162	1.479

Recommended number of passes and radial depth of cut per pass for female NPT thread (60°).

		Radial depth of cut per pass [mm]			
		27	18	14	11.5
No. of passes	1	0.283	0.348	0.390	0.423
	2	0.233	0.287	0.322	0.349
	3	0.214	0.263	0.295	0.320
	4	–	0.202	0.226	0.246
	5	–	–	0.190	0.207
	6	–	–	–	0.183
	7	–	–	–	–
Acc. Depth		0.730	1.100	1.423	1.728

General hints on thread milling

1. Thread milling is the process of generating a thread by the circular interpolation of a milling cutter with a specific thread geometry ground around it's periphery.
2. To be able to use a thread milling cutter it is necessary to have a CNC machine that can make circular paths.
3. Most modern CNC machines are equipped with machining cycles for thread milling.
4. Consult the manual or contact the machine supplier for information.

Features and benefits

1. Thread milling gives increased reliability and tool life.
2. Threadmills produce small chips resulting in problem free threading.
3. Tolerance adjustments can be made using exact co-ordinates.
4. You can generate a complete thread to the bottom of the hole.
5. Capable of machining a wide variety of materials.
6. The same cutter can produce different size threads provided the pitch is the same.
7. Both right and left hand threads can be created with the same tool.
8. Some thread mills can also machine the entry chamfer (J200 and J205).

Choosing your tool

Thread milling cutters have an item code based on the type, diameter (d_1) and pitch (P). The item code is the number to use when ordering your tool. Always consult the catalogue to ensure you have the correct thread dimensions.

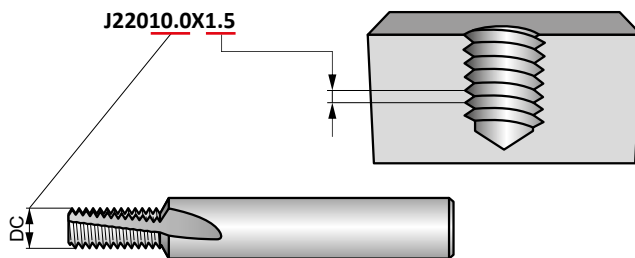

This thread milling cutter can be used for threads \geq M12 \times 1.5 (M14 \times 1.5, M18 \times 1.5 etc.)

Programming with Rprg

- For easy adjustment of the thread tolerance always program with radius correction.
- The Rprg value is the start value for a new cutter and is printed on the cutter shank. This should be entered in the tool memory offset.
- Rprg is based on the theoretical zero-line of the thread meaning that when you program using Rprg the thread is never oversize, but normally tight.
- This means that with a small modification to the program co-ordinates you can create the thread to the required size.

Recommendations

- Always use the correct cutting data (refer to the cutting data chart in the Product section).
- Use the recommended drill size for the thread diameter, as for conventional taps.
- For easy adjustment of the thread tolerance always start with the Rprg value printed on the shank of the threadmill.
- Use a gauge to check the tolerance on the first thread to establish if the radius needs to be corrected. The radius can be corrected 2 or 3 times before the threadmill is worn out.
- When dry machining, compressed air is recommended to help with swarf removal.
- When threading more difficult materials, it is recommended to take multiple passes.



DORMER PRAMET



ALWAYS CONNECT

No wifi or internet connection? The machining calculator works perfectly even when you are offline, making sure it's always available when you need it. **Simply Reliable.**





INDEXABLE MILLS





MILLING – GENERAL CONTENT

6		WMG & ISO 13399
10	SOLID MILLS	INSTRUCTIONS
19		HM MILLS
117		HSS-E-PM, HSS-E, HSS MILLS
201		TECHNICAL INFORMATION
212		ROTARY BURRS
292		THREAD MILLS
314	INDEXABLE MILLS	INSTRUCTIONS
328		NAVIGATORS
349		FACE MILLS
409		SQUARE SHOULDER MILLS
479		DEEP SHOULDER MILLS
508		SLOT MILLS
521		COPY MILLS
613		HIGH FEED MILLS (HFC)
645		CHAMFER & T-SLOT MILLS
667		OTHER INSERTS
691		TECHNICAL INFORMATION



1 **SAD11E**



5 **FORCE AD11 Square Shoulder Mill with Internal Coolant**

90° end and shell mills utilising positive AD. 11 style insert with APMX of 9 mm. Suitable for face, shoulder, slot, helical, trochoidal, ramping and plunge milling. Available in cylindrical, Weldon, Morse taper, modular and arbor (with differential tooth pitch) style, in Ø16 up to Ø125 mm. Body treated for longer tool life.

FORCE AD

KAPR	90°
APMX	9.0 mm

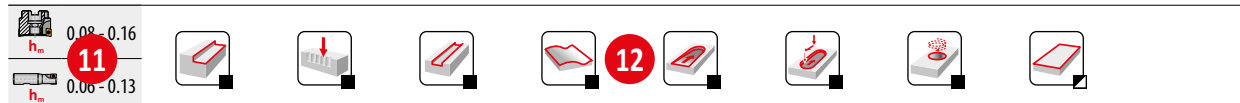
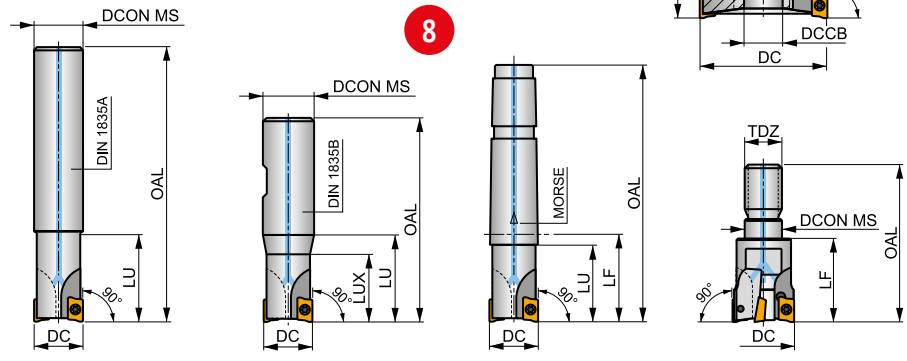
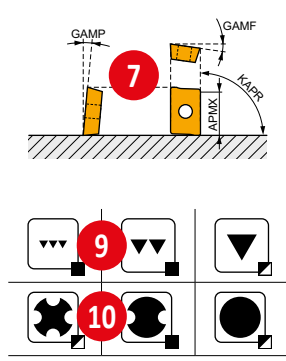

Product	DC	OAL	DCON MS	DCCB	LU	LUX	LF	TDZ	CZC MS	KWW	KWD	GAMP	GAMP	max.	kg	Material	Coating				
	(mm)	(mm)	(mm)	(mm)	(mm)	(mm)	(mm)	(mm)	(mm)	(mm)	(mm)	(°)	(°)	(%)							
14 16A2R02...SAD11E-C	16	160	14	-	24	-	-	-	-	-	-	-12.8	4	16	17	18	19	20	21	22	23
16A2R024A16-SAD11E-C	16	135	16	-	24	-	-	-	-	-	-	-12.8	4	2	30100	0.19	GI169	SQ025	-	-	
16A2R050A16-SAD11E-C	16	135	16	-	50	-	-	-	-	-	-	-12.8	4	2	28400	0.35	GI169	SQ025	-	-	
18A2R029A20-SAD11E-C	18	150	20	-	29	-	-	-	-	-	-	-12	4.5	2	27000	0.33	GI169	SQ020	-	-	
20A2R029A20-SAD11E-C	20	150	20	-	29	-	-	-	-	-	-	-11.5	5	2	27000	0.33	GI169	SQ020	-	-	
20A2R070A20-SAD11E-C	20	150	20	-	70	-	-	-	-	-	-	-11.5	5	2	27000	0.32	GI169	SQ020	-	-	
20A3R029A18-SAD11E-C	20	200	18	-	29	-	-	-	-	-	-	-11.5	5	3	27000	0.38	GI169	SQ025	-	-	
20A3R029A20-SAD11E-C	20	150	20	-	29	-	-	-	-	-	-	-11.5	5	3	27000	0.33	GI169	SQ025	-	-	
22A3R029A20-SAD11E-C	22	200	20	-	29	-	-	-	-	-	-	-11.5	5	3	25600	0.49	GI169	SQ025	-	-	
25A3R034A25-SAD11E-C	25	170	25	-	34	-	-	-	-	-	-	-10.2	5	3	24100	0.42	GI169	SQ020	-	-	

GI169	ADMX 11T3..	24	ADEX 11T3..
-------	-------------	----	-------------

SQ020	US 62506-T07P	1.2	M 2.5	6	25	-	Flag T07P	-
SQ021	US 62506-T07P	1.2	M 2.5	6	-	D-T07P/T09P	FG-15	-
SQ022	US 62506-T07P	1.2	M 2.5	6	-	D-T07P/T09P	FG-15	HS 0830C
SQ023	US 62506-T07P	1.2	M 2.5	6	-	D-T07P/T09P	FG-15	HS 1030C
SQ025	US 62505-T07P	1.2	M 2.5	5	-	-	-	Flag T07P

AC001	KS 1230	26	K.FMH27
AC002	KS 1635	K.FMH32	
AC003	KS 2040	K.FMH40	



INDEXABLE MILLS – PAGE OVERVIEW

Pos.	Description	Pos.	Description
1	Designation of cutter	14	ISO code of cutter
2	Material group recommendations	15	Dimensions [mm], angles ¹⁾ [°] and connection size code
3	Clamping system of insert	16	Number of teeth
4	Illustrative picture	17	Irregular teeth pitch
5	Tool description	18	Maximum revolutions of cutter
6	Setting angle and maximum theoretical depth of cut [mm]	19	Internal supply of coolant
7	Tool geometry	20	Weight [kg]
8	Schematic drawing of tool	21	Group of compatible inserts ²⁾
9	Achievable quality of surface	22	Group of spare parts ²⁾
10	Character of cut/working conditions	23	Group of special accessories ²⁾
11	Maximum range of mean chip thickness [mm] for end milling cutters and/or shell milling cutters	24	Compatible inserts
12	Product applications	25	Spare parts
13	Shank type	26	Special accessories

¹⁾ γ_f = Radial rake setting angle (**GAMP**) of insert pocket – see indexable mills technical information

γ_p = Axial rake setting angle (**GAMP**) of insert pocket – see indexable mills technical information

²⁾ Spare parts and special accessories icons are designed schematically for their ease of understanding. They aren't included in the list of icons. Screws are, in some cases, completed with info on torque value in Nm, length of screw and size of thread.

1

ADMX 11

	W1	D1	L	S
	[mm]	[mm]	[mm]	[mm]
11T3	6.530	2.90	11.00	3.97

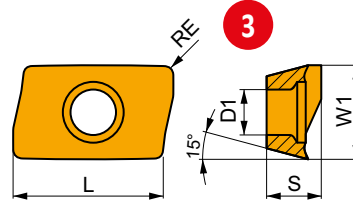

Suitability and starting values for cutting speed (vc), feed (f) and depth of cut (ap). Refer to our Machining Calculator app for further calculations.

Product	RE	P			M			K			N			S			H		
		vc	f	ap	vc	f	ap	vc	f	ap	vc	f	ap	vc	f	ap	vc	f	ap
	[mm]	[m/min]	[mm/tooth]	[mm]	[m/min]	[mm/tooth]	[mm]	[m/min]	[mm/tooth]	[mm]	[m/min]	[mm/tooth]	[mm]	[m/min]	[mm/tooth]	[mm]	[m/min]	[mm/tooth]	[mm]

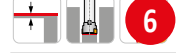
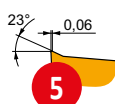

F geometry with very sharp positive design for light machining.

ADMX 11T304SR-F	8215	0.4	245	0.10	2.0	145	0.09	2.0	230	0.10	2.0	735	0.12	2.0	60	0.08	1.6	-	-	-
	M8310	0.4	270	0.10	2.0	135	0.09	2.0	255	0.10	2.0	-	-	-	-	-	-	-	-	-
	M8340	0.4	240	0.10	2.0	140	0.09	2.0	225	0.10	2.0	720	0.12	2.0	60	0.08	1.6	-	-	-
	M9340	0.4	220	0.10	2.0	130	0.09	2.0	205	0.10	2.0	-	-	-	55	0.08	1.6	-	-	-
ADMX 11T308SR-F	8215	0.8	290	0.10	2.0	170	0.09	2.0	275	0.10	2.0	870	0.12	2.0	70	0.08	1.6	-	-	-
	M8330	0.8	285	0.10	2.0	170	0.09	2.0	270	0.10	2.0	855	0.12	2.0	70	0.08	1.6	-	-	-
	M8340	0.8	260	0.10	2.0	155	0.09	2.0	245	0.10	2.0	-	-	-	65	0.08	1.6	-	-	-
	M9340	0.8	340	0.10	2.0	200	0.09	2.0	-	-	-	-	-	85	0.08	1.6	-	-	-	

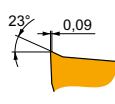
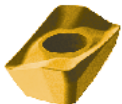

M geometry with positive design for light to medium machining.

ADMX 11T302SR-M	M8330	0.2	190	0.15	4.0	110	0.14	4.0	180	0.15	4.0	-	-	-	45	0.12	3.2	-	-	-
	M8340	0.2	170	0.15	4.0	100	0.14	4.0	160	0.15	4.0	-	-	-	40	0.12	3.2	-	-	-
ADMX 11T304SR-M	8215	0.4	205	0.15	4.0	120	0.14	4.0	190	0.15	4.0	-	-	-	50	0.12	3.2	-	-	-
	M8310	0.4	220	0.15	4.0	110	0.14	4.0	205	0.15	4.0	-	-	-	-	-	-	-	-	-

ADMX 11T304SR-M:M8310

Use full insert specification code when ordering!

Grade

Include colon

ISO insert code



MILLING INSERTS – PAGE OVERVIEW

Pos.	Description	Pos.	Description
1	Designation of insert	7	ISO insert code
2	Table with insert sizes [mm]	8	Grade
3	Schematic drawing of insert	9	Insert radii [mm]
4	Picture of representative insert	10	Geometry description
5	Profile of main cutting edge	11	Application area of insert ¹⁾
6	Icons – specific features and cutting edge type		

¹⁾ Recommendations for cutting speed corrections can be found at the end of Milling chapter in the technical section.



Technical information follows immediately after the milling cutter pages, their compatible inserts and info on starting cutting speeds. These will help you to use the tools in the correct way. If you are unsure how to use or interpret this information, either refer to the technical section at the end of the milling chapter or contact your Dormer Pramet representative.



INDEXABLE MILLS – ICONS OVERVIEW

General icons

	Primary use		Material group P		Finishing – very good surface quality
	Possible use		Material group M		Medium machining – good surface quality
			Material group K		Roughing – unlimited surface roughness
			Material group N		Suitable for stable working conditions
			Material group S		Suitable for unstable working conditions
			Material group H		Suitable for heavy working conditions

Milling Operations

	Face Milling		T-slot Milling		Plunge Milling
	Shallow shoulder milling		Contoured Surfaces (copy milling)		Progressive Plunging
	Deep shoulder milling		Chamfer Milling		Ramping
	Shallow slot milling		Helical interpolation		Rear face milling
	Deep slot milling		Helical interpolation in a pre-drilled hole		

Shanks

	Shell mill DIN 8030		DIN 1835B Weldon Shank		Arbor DIN 69871-1
	Shell mill DIN 8030 – helical mill		Morse shank DIN 228-1		Arbor MAS BT (JIS-B-6339)
	Shell mill DIN 8030 – disc mill		Polygon shank coupling ISO 26623-1		Threaded coupling
	DIN 1835A Cylindrical Shank		Arbor DIN 2080-1		



INDEXABLE MILLS – ICONS OVERVIEW

Features

	First choice		Long overhang		Rounded edge
	Heavy working conditions		Thin-walled and slim workpieces		Edge with facet
	High Feed Cutting		Universal wide range option		Rounded edge with facet
	Insert with Wiper geometry		Sharp edge		Rounded edge with double facet

Others

	Clamping torque of screw [Nm]
	Effective number of teeth
	Number of teeth (helical cutters)

Technical Parts

	Chamfering angle [°]		Hole diameter [mm]		Maximal angle for ramping [°]
	Depth of cut [mm]		Feed [mm/tooth]		Maximal depth per revolution for maximal diameter of hole [mm]
	Maximum cutting depth over the length of cut [mm]		Minimal feed [mm/tooth]		Maximal depth per revolution for minimal diameter of hole [mm]
	Wiper edge length [mm]		Maximal feed [mm/tooth]		Starting feed [mm/tooth]
	Multiplication factor for feed (machining on centre line)		Chipbreaker		Contouring step in conventional milling [mm]
	Multiplication factor for feed (machining off centre line)		Effective working length of tool [mm]		Contouring step in up/down cross milling [mm]
	Multiplication factor for cutting speed		Maximum width of machined area [mm]		Roughness of machined surface R_a [μm]
	Diameter of cutter [mm]		Number of edges in use		Time [min]
	Maximum diameter of cutter [mm]		Number of teeth		Thread pitch
	Effective diameter of cutter [mm]		Ratio [%] of radial width of cut to cutting diameter		Threads per inch
	Cutting depth for plunging [mm]		Ratio [%] of radial width of cut to maximal cutting diameter		
	Effective reach of tool [mm]		Corner radius of insert [mm]		

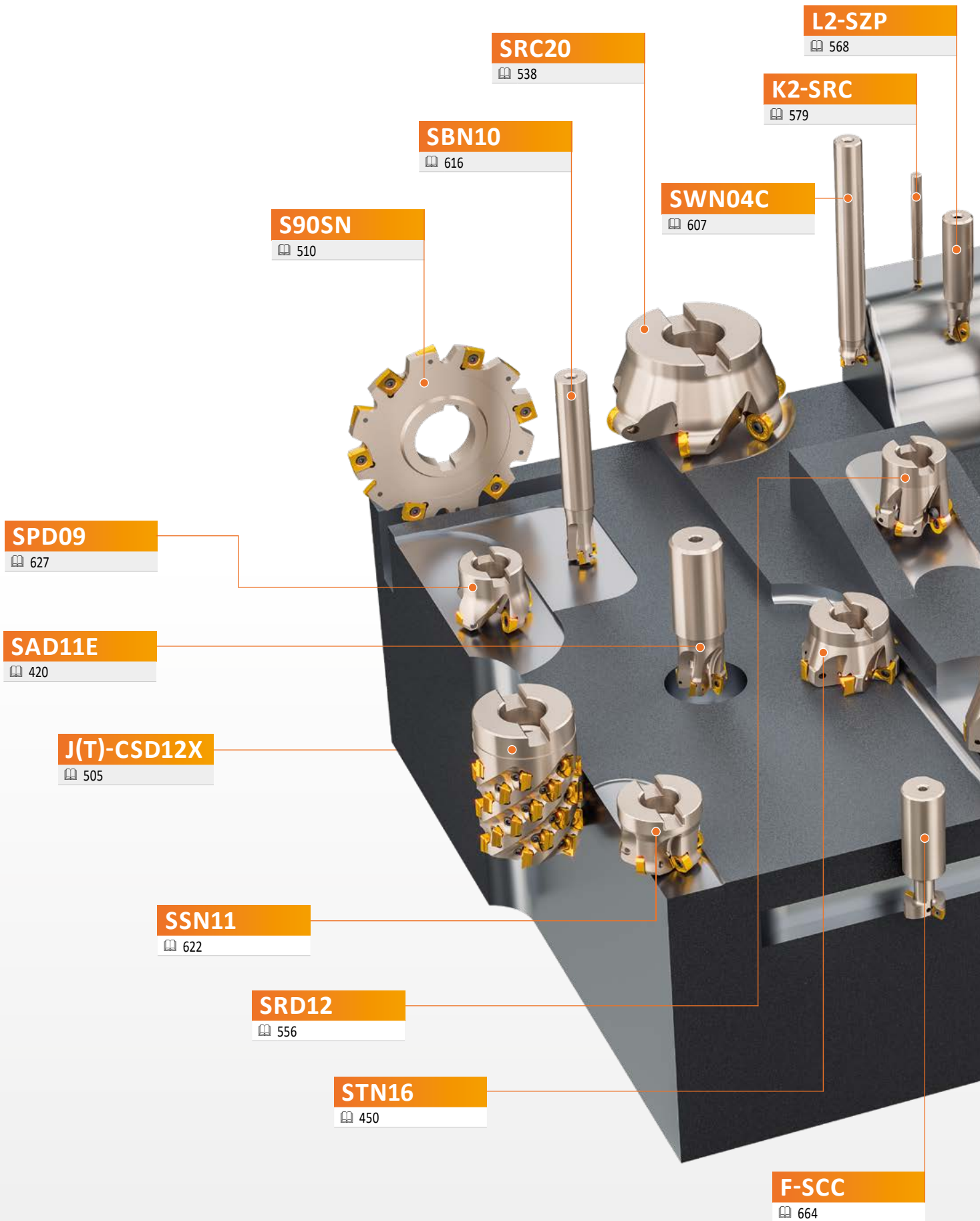

SRC20

📖 538

L2-SZP

📖 568

K2-SRC

📖 579

SBN10

📖 616

SWN04C

📖 607

S90SN

📖 510

SPD09

📖 627

SAD11E

📖 420

J(T)-CSD12X

📖 505

SSN11

📖 622

SRD12

📖 556

STN16

📖 450

F-SCC

📖 664



INDEXABLE MILLS NAVIGATOR – PROGRAM OVERVIEW

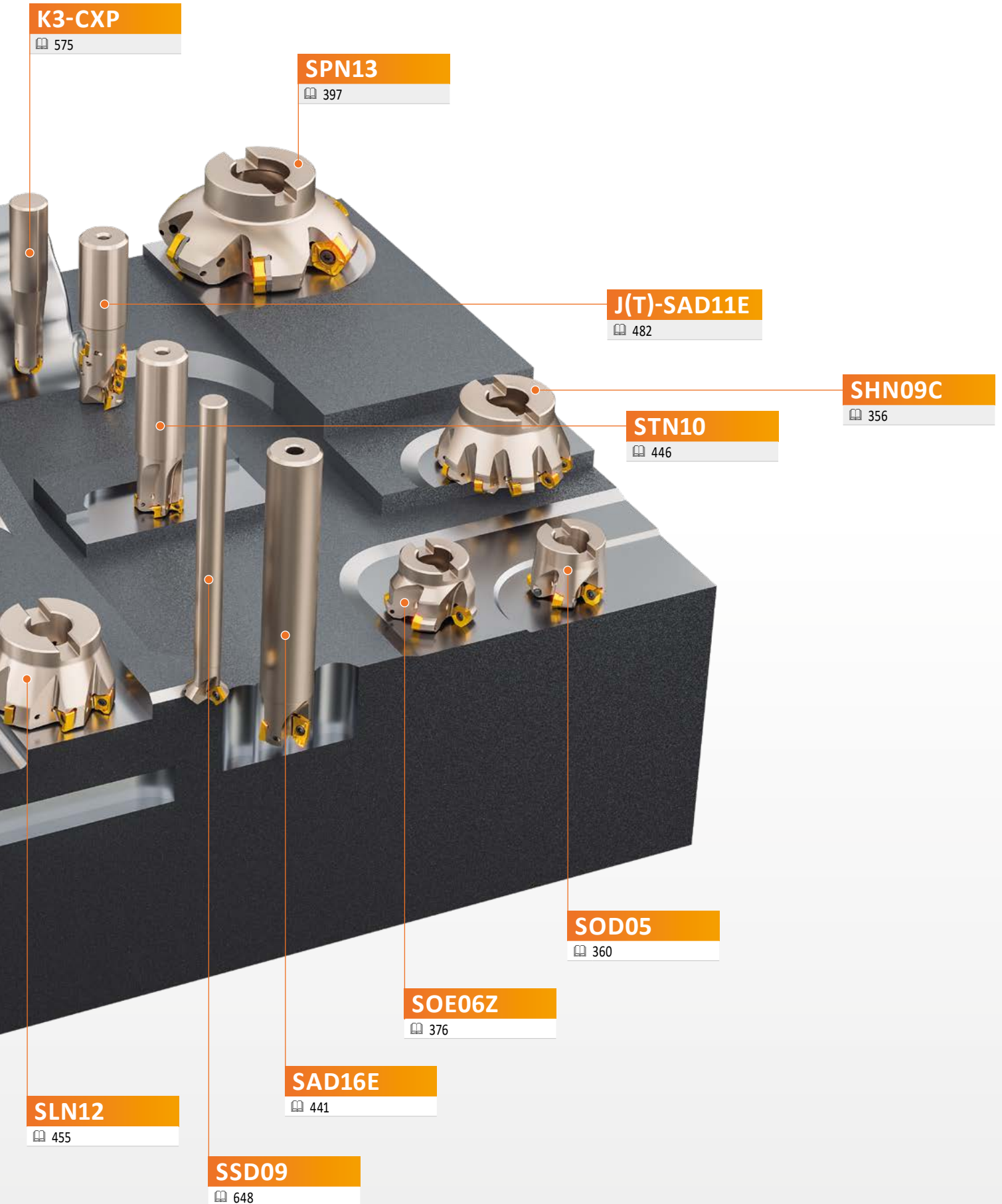

K3-CXP

575

SPN13

397

J(T)-SAD11E

482

SHN09C

356

STN10

446

SOD05

360

SOE06Z

376

SAD16E

441

SLN12

455

SSD09

648



INDEXABLE MILLING GRADES – NAVIGATOR

Group	Cemented carbide with MTCVD	Cemented carbide with PVD	Uncoated
P01			
P05		M8310	
P10	M9315	8215	
P15	M9325		
P20		M8330	
P25		M8340	
P30		M8345	
P35			
P40			
P45			
P50			

Group	Cemented carbide with MTCVD	Cemented carbide with PVD	Uncoated
M01			
M05			
M10			
M15			
M20		M6330	
M25		M8340	
M30	M9340	M8345	
M35			
M40			
M45			
M50			

Group	Cemented carbide with MTCVD	Cemented carbide with PVD	Uncoated
K01		M4303	
K05		M8310	
K10	M5315	M4310	
K15		8215	
K20		M8330	
K25			
K30			
K35			
K40			
K45			
K50			

Group	Cemented carbide with MTCVD	Cemented carbide with PVD	Uncoated
N01			
N05			
N10		M0315	
N15		8215	
N20			HF7
N25			
N30			
N35			
N40			
N45			
N50			

Group	Cemented carbide with MTCVD	Cemented carbide with PVD	Uncoated
S01			
S05			
S10			
S15	M9340		
S20		M6330	
S25		M8340	
S30		M8345	
S35			
S40			
S45			
S50			

Group	Cemented carbide with MTCVD	Cemented carbide with PVD	Uncoated
H01		M4303	
H05		2003	
H10	M5315	M4310	
H15		M8310	
H20		8215	
H25			
H30			
H35			
H40			
H45			
H50			



MILLING GRADES – OVERVIEW

Grade Identification	Area of Application	Application	Feed	Cutting speed	Resistance to adverse Working Conditions	Coating	Colour	Substrate	Coolant benefit	Grade description
M9315	P05 – P25	■				MT-CVD	█	H	---	Milling grade with high abrasion resistance even at high thermal loads, main application area is higher cutting speeds with medium or small depths of cut.
	K10 – K30	■	▴	▴	▴					
	H10 – H20	▣								
M9325	P10 – P30	■				MT-CVD	█	H	---	This grade has an ideal balance between wear resistance and toughness, it is mainly designed for roughing operations. Advantages are excellent wear resistance even at relatively high cutting speeds with excellent reliability, this grade is more suitable for applications using higher speeds and lower feed rates.
	K10 – K30	■	▴	▴	▴					
	H15 – H20	▣								
M9340	P35 – P50	■				MT-CVD	█	H	---	A very tough grade, where the main advantage is the high strength of the cutting edge and resistance to adverse cutting conditions. Although this material has an MT-CVD M30 – M40 coating, it is possible to use emulsion cooling for its application, especially in optimum cutting conditions.
	M30 – M40	■	▴	▴	▴					
	S15 – S20	■								
M5315	P05 – P20	▣				MT-CVD	█	H	---	One of the most abrasion-resistant milling grades which should be used under stable conditions. Its main advantage is the extremely high resistance to thermal stress and abrasive K05 – K25 wear. It is mainly used for machining hard and very hard materials, particularly cast iron.
	K05 – K25	■	▴	▴	▴					
	H05 – H20	■								
M8310	P01 – P10	■				PVD	█	ultra submicron H	-	Grade specially developed for copy milling, featuring high resistance to abrasion. It is suitable for machining at higher cutting speeds under stable cutting conditions, and for machining virtually all groups of machined materials (particularly stronger and harder materials).
	M01 – M10	▣	▴	▴	▴					
	K01 – K10	■	▴	▴	▴					
	H05 – H15	▣								
8215	P10 – P20	■				PVD	█	submicron H	+ / -	One of the most versatile milling grades, in terms of both the range of workpiece materials and the range of possible applications. It is characterised by high wear resistance and operational reliability. Its other advantages include excellent resistance to cracking induced by temperature shock. With its unique properties, this material is undoubtedly one of the pillars of the milling range.
	M10 – M20	▣	▴	▴	▴					
	K10 – K25	■	▴	▴	▴					
	N10 – N25	■								
	S10 – S15	▣								
M8325	P20 – P40	■				PVD	█	S	-	The main application area of this grade is machining all kinds of steels (including stainless) in the "soft state". It can also be used for machining softer cast irons. Suitable for M15 – M30 machining at medium speeds under average cutting conditions.
	M15 – M30	▣	▴	▴	▴					
M8330	P20 – P40	■				PVD	█	submicron H	+ / -	This grade is universal and can be used for machining various types of materials. However, it's priority application area lies within steels and ductile cast irons. It is recommended for milling at medium speeds under unstable cutting conditions.
	M20 – M35	■	▴	▴	▴					
	K20 – K40	■	▴	▴	▴					
	N15 – N30	▣								
	S15 – S25	▣								
M8340	P25 – P50	■				PVD	█	submicron H	+ / -	Grade specially developed for copy milling, featuring high resistance to abrasion. It is suitable for machining at higher cutting speeds under stable cutting conditions, and for machining virtually all groups of machined materials (particularly stronger and harder materials).
	M20 – M40	■	▴	▴	▴					
	K20 – K40	▣	▴	▴	▴					
	S20 – S30	■								



MILLING GRADES – OVERVIEW

Grade Identification	Area of Application	Application	Feed	Cutting speed	Resistance to adverse Working Conditions	Coating	Colour	Substrate	Coolant benefit	Grade description
M8345	P30 – P50	■				PVD		H	-	This grade has exceptional operational reliability and is designed for heavy cuts in unfavourable conditions in difficult and tough materials.
	M30 – M40	■								
M6330	P20 – P35	■				PVD		H	+ / -	Milling grade with extraordinary service reliability. Especially suitable for machining of hard to machine materials. Powerful in applications where unfavourable conditions and heavy cuts dominate.
	M20 – M35	■								
	S20 – S30	■								
M4303	P01 – P10	▣				PVD		ultra submicron H	-	The most wear resistant grade for mold & die applications. Offers exceptional performance at high cutting speeds and low feeds in stable cutting conditions. Suitable for finishing operations in difficult workpiece materials.
	K01 – K10	■								
	N01 – N10	▣								
	H01 – H10	■								
M4310	P05 – P15	▣				PVD		ultra submicron H	-	Universal grade for mold & die applications. Suitable for finishing as well as semi-roughing operations. This grade combines high wear resistance with extraordinary operational reliability.
	M05 – M15	▣								
	K05 – K15	■								
	S05 – S10	■								
	H05 – H15	■								
2003	P01 – P10	▣				PVD		ultra submicron H	-	Milling grade with excellent wear resistance. Most suitable in a machining of hard and high strength materials under stable cutting conditions and moderate/higher cutting speeds. Suitable for cutting other workpiece group materials except non-ferrous metals.
	M01 – M10	▣								
	K01 – K10	■								
	S05 – S10	■								
M0315	N05 – N25	■				PVD		submicron H	-	Submicron grade for milling non-ferrous metals and their alloys with a balanced ratio of wear resistance and toughness. It is provided with a unique coating with excellent friction properties.
S26	P15 – P30	■				-		S	++	Uncoated milling grade with excellent resistance to erosion of the cutting face. It is intended solely for machining carbon and alloy steels at low cutting speeds.
S45	P30 – P45	■				-		S	++	Uncoated, tough cutting grade suitable for machining applications where low cutting speed and unfavourable cutting conditions dominate
HF7	M10 – M20	▣				-		submicron H	++	Uncoated grade which is primarily designed for machining non-ferrous metals; can also be used for other machined materials (except steel). This grade can be used in turning, milling, and even boring.
	K10 – K25	■								
	N10 – N25	■								



MILLING GRADES – OVERVIEW

Substrate

H	WC-Co based substrate
submicron H	WC-Co based substrate, fine-grained (< 1 µm)
ultra submicron H	WC-Co based substrate, very fine-grained (< 0,5 µm)
S	Substrate with cubic carbides

Coating

MT-CVD	Medium-temperature chemical method of coating
PVD	Low-temperature physical method of coating
×	Uncoated grade

Coolant Benefit

---	Very negative effect on tool life – cooling is not recommended
-	Slightly negative effect on tool life
+ / -	Influence of cooling may be both positive and negative – decisive factor is specific working conditions
++	Positive effect on tool life – cooling is recommended

Attribute Strength





















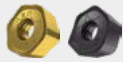

Level 1–5



INDEXABLE MILLS – NAVIGATOR

FACE MILLING





























	SHN06C		SHN09C		SOD05		SOD06D		SOE06Z															
	45°		45°		45°		45°		43°															
	APMX [mm]	3.0	APMX [mm]	5.0	APMX [mm]	2.7 (10.0)	APMX [mm]	3.1 (8, 6)	APMX [mm]	3.3 (9.9)														
	DC [mm]	25 – 125	DC [mm]	50 – 315	DCX [mm]	32 – 125	DC [mm]	63 – 160	DC [mm]	50 – 200														
Cylindrical shank							DCX = 32 – 40 [mm]																	
Weldon			DC = 25 – 32 [mm]																					
Modular			DC = 25 – 40 [mm]																					
Shell mill																								
	DC = 40 – 125 [mm]				DCX = 40 – 125 [mm]																			
Page	📖 352		📖 356		📖 360		📖 370		📖 376															
ISO	P	M	K		H	P	M	K		H	P	M	K	N		P	M	K	S	H	P	M	N	S
Insert shape																								
Inserts	HNGX 0604 XNGX 0604		HNGX 0906 XNGX 0906		OD.. 0505 RD.. 1205 SD.. 1205		OD.. 0605 RPE.. 1505		OEHT 0604 REHT 1604 XEHT 0604															
No. of cutting edges	12 / 1		12 / 1		8 / - / 4		8 / 1 / -		8 / - / 1															
Face milling 	■		■		■		■		■															
Chamfer milling 	■		■		■		■		■															
Helical interpolation 					■				▣															
Progressive plunging 	■		■		■				▣															
Ramping 	■		■		■				▣															
Shape surfaces milling (copy milling) 					■				▣															
Shallow shoulder milling 					■																			
Shallow slot milling 					■																			
Plunge milling 					■																			



INDEXABLE MILLS – NAVIGATOR



FACE MILLING



























	SOE09Z	SSE09	SSN12Z	SPN13	CHN09	FSB22X
	43°	45°	45°	57°	60°	60°
	APMX [mm] 5.0 (14.1)	APMX [mm] 4.5	APMX [mm] 6.5	APMX [mm] 10.0	APMX [mm] 6.0	APMX [mm] 15.0
	DC [mm] 80 – 315	DC [mm] 20 – 160	DC [mm] 50 – 250	DC [mm] 100 – 315	DC [mm] 80 – 125	DC [mm] 125 – 315
			DC = 20 – 32 [mm]			
			DC = 32 – 160 [mm]			
						
	P M N S	P M K S	P M K S	P M K S H	K	P M K
						
	OEHT 0906 REHT 2406 XEHT 0906	SE.T 09T3	SN.T 1205	PNM. 1308 XN.. 1308	HN.. 0905	SB.. 2207
	8 / - / 1	4	4	10 / 1	12	4 / 1
	■	■	■	■	■	■
	■	■	■			
	▣					
	▣					
	▣					
	▣					
						
						
						



INDEXABLE MILLS – NAVIGATOR

SQUARE SHOULDER MILLING



	SAD07D		SAD11E		SAD16E		SAP10D		SAP16D																		
	90°		90°		90°		90°		90°																		
	APMX [mm]	5.0	APMX [mm]	9.0	APMX [mm]	13.0	APMX [mm]	9.0	APMX [mm]	13.0																	
	DC [mm]	10 – 32	DC [mm]	16 – 125	DC [mm]	25 – 175	DC [mm]	10 – 63	DC [mm]	25 – 160																	
Cylindrical shank		DC = 10 – 25 [mm]		DC = 16 – 35 [mm]		DC = 25 – 32 [mm]																					
Weldon				DC = 16 – 32 [mm]		DC = 25 – 40 [mm]		DC = 10 – 25 [mm]		DC = 25 – 40 [mm]																	
Modular		DC = 12 – 32 [mm]		DC = 16 – 40 [mm]		DC = 32 – 40 [mm]																					
Shell mill				DC = 40 – 125 [mm]		DC = 40 – 175 [mm]		DC = 40 – 63 [mm]		DC = 40 – 160 [mm]																	
Page	413		420		429		438		441																		
ISO	P	M	K	N	S	P	M	K	N	S	H	P	M	K	N	S	H	P	M	K	N	S	P	M	K	N	S
Insert shape																											
Inserts	AD.X 0702		AD.X 11T3		AD.X 1606		APKT 1003		APT 1604																		
No. of cutting edges	2		2		2		2		2																		
Shallow shoulder milling 	■		■		■		■		■																		
Helical interpolation 	■		■		■		■		■																		
Shallow slot milling 	■		■		■		■		■																		
Plunge milling 	■		■		■		■		■																		
Progressive plunging 	■		■		■		■		■																		
Ramping 	■		■		■		■		■																		
Face milling 	▣		▣		▣		▣		▣																		
Shape surfaces milling (copy milling) 	▣		■		■																						



INDEXABLE MILLS – NAVIGATOR



SQUARE SHOULDER MILLING















	STN10		STN16		SLN12		SLN16		SSO050		SSO09									
	90°		90°		90°		90°		90°		90°									
	APMX [mm]	5.0	APMX [mm]	10.0	APMX [mm]	9.0	APMX [mm]	13.0	APMX [mm]	4.5	APMX [mm]	8.0								
	DC [mm]	18 – 32	DC [mm]	25 – 175	DC [mm]	25 – 125	DC [mm]	63 – 175	DC [mm]	12 – 40	DC [mm]	20 – 125								
		DC = 18 – 32 [mm]		DC = 25 – 35 [mm]		DC = 25 – 32 [mm]				DC = 12 – 25 [mm]										
		DC = 20 – 32 [mm]		DC = 25 – 40 [mm]		DC = 25 – 40 [mm]				DC = 20 – 32 [mm]		DC = 20 – 32 [mm]								
		DC = 20 – 32 [mm]		DC = 25 – 40 [mm]		DC = 25 – 40 [mm]														
		DC = 40 – 80 [mm]		DC = 40 – 175 [mm]		DC = 40 – 125 [mm]				DC = 32 – 40 [mm]		DC = 40 – 125 [mm]								
	📖 446		📖 450		📖 455		📖 461		📖 466		📖 469									
	P	M	K	N	P	M	K	N	P	K	N	H	P	M	K	S	P	M	K	S
	TNGX 1004		TNGX 1606		LNG. 1205		LN.U 1607		SOMT 0502		SOMT 09T3									
	6		6		4		4		4		4									
	■		■		■		■		■		■									
	▣		▣		▣															
	■		■		■		■		■		■									
	▣				■		■		■		■									
	▣				▣															
	▣				▣															
	■		■		▣						▣									
					▣		▣		■											



INDEXABLE MILLS – NAVIGATOR

←←← SQUARE SHOULDER MILLING

















	SSD12		FTB27X																	
	90°		90°																	
	APMX [mm]	10.0	APMX [mm]	18.0																
	DC [mm]	50 – 160	DC [mm]	140 – 260																
Cylindrical shank																				
Weldon																				
Modular																				
Shell mill																				
Page	📖 472		📖 475																	
ISO	P	M	K	N	S	P	M	K												
Insert shape																				
Inserts	SDMT 1205		TBMR 2707																	
No. of cutting edges	4		3																	
Shallow shoulder milling 	■		■																	
Helical interpolation 																				
Shallow slot milling 	■		▣																	
Plunge milling 	■																			
Progressive plunging 																				
Ramping 																				
Face milling 	▣		▣																	
Shape surfaces milling (copy milling) 																				



INDEXABLE MILLS – NAVIGATOR









DEEP SHOULDER MILLING



	J(T)-SAD11E		J(T)-SAD16E		J(T)-SLSN		J(T)-SSAP		J(T)-2416																			
	90°		90°		90°		90°		90°																			
	APMX [mm]	37.0 – 56.0	APMX [mm]	40.0 – 108.0	APMX [mm]	104.0 – 134.0	APMX [mm]	58.0 – 95.0	APMX [mm]	40.0 – 63.0																		
	DC [mm]	25 – 50	DC [mm]	50 – 100	DC [mm]	63 – 80	DC [mm]	50 – 80	DC [mm]	20 – 40																		
Weldon			DC = 25 – 40 [mm]																									
Morse taper			DC = 25 – 40 [mm]																									
Arbor				DC = 50 – 80 [mm]																								
Shell mill			DC = 50 [mm]			DC = 50 – 100 [mm]																						
Page	482		488		494		498		503																			
ISO	P	M	K	N	S	H	P	M	K	N	S	H	P	K			P	M	K	N	S	H	P	M	K	N		
Insert shape									–																			
Inserts	AD 11T3		AD.. 1606		LNET 1606 SN.. 1305		APE. 150412 SPE. 1204		–																			
No. of cutting edges	2		2		2/8		2/4		–																			
Deep shoulder milling 	■		■		■		■		■																			
Deep slot milling 	■		■		■		■		▣																			
Face milling 	▣		▣		▣		▣		▣																			
Plunge milling 	▣		▣		▣		▣		▣																			









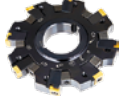

DEEP SHOULDER MILLING

		J(T)-CSD12X				
		90°				
		APMX [mm]	44.1 – 87.3			
		DC [mm]	40 – 63			
PCS		DC = 40 – 50 [mm]				
Morse taper		DC = 50 [mm]				
Arbor		DC = 40 – 63 [mm]				
Shell mill		DC = 50 – 80 [mm]				
Page	📖 505					
ISO	P	M	S			
Insert shape						
Inserts	SD.X 1205					
No. of cutting edges	4					
Deep shoulder milling		<input checked="" type="checkbox"/>				
Deep slot milling		<input checked="" type="checkbox"/>				
Face milling		<input type="checkbox"/>				
Plunge milling		<input type="checkbox"/>				



SLOT MILLING



























	S90SN		S90CN(XN)				
	90°		90°				
	APMX [mm]	4.0 – 14.0	APMX [mm]	14.0 – 30.5			
	DC [mm]	80 – 200	DC [mm]	125 – 315			
Disc		DC = 80 – 200 [mm]		DC = 125 – 315 [mm]			
Shell mill			DC = 63 – 160 [mm]			DC = 125 – 200 [mm]	
Page	510		516				
ISO	P	M	K		P	M	K
Insert shape							
Inserts	SNHQ 11 SNHQ 12		CNHQ 1005 XNHQ 1205 XNHQ 1606				
No. of cutting edges	4		2				
Deep slot milling		■	■				
Deep shoulder milling		▣	▣				
Face milling		▣	▣				
Rear face milling		▣	▣				



INDEXABLE MILLS – NAVIGATOR

COPY MILLING



	SRC10	SRC12	SRC16	SRC20	SRD05
	–	–	–	–	–
	APMX [mm] 5.0	APMX [mm] 6.0	APMX [mm] 8.0	APMX [mm] 10.0	APMX [mm] 1.5
	DCX [mm] 25 – 66	DCX [mm] 40 – 100	DCX [mm] 63 – 160	DCX [mm] 80 – 160	DCX [mm] 10 – 15
Cylindrical shank					
	DCX = 25 – 32 [mm]				
Weldon					
Modular					
	DCX = 25 – 42 [mm]				
Shell mill					
	DCX = 40 – 66 [mm]				
Page	 526	 530	 534	 538	 542
ISO	P M K S H	P M K S H	P M K S H	P M K S H	P K H
Insert shape					
Inserts	RC 10T3	RC 1204	RC 1606	RC 2006	RD 0501
No. of cutting edges	–	–	–	–	–
Shape surfaces milling (copy milling) 	■	■	■	■	■
Face milling 	■	■	■	■	■
Helical interpolation 	■	■	■	■	■
Progressive plunging 	■	■	■	■	■
Ramping 	■	■	■	■	■
Shallow shoulder milling 					
Deep shoulder milling 					
Chamfer milling 					
Plunge milling 					































INDEXABLE MILLS – NAVIGATOR



COPY MILLING



























	SRD07		SRD10		SRD12		SRD16		L2-SZP		K3-CXP													
	-		-		-		-		-		-													
	APMX [mm]	2.0	APMX [mm]	2.5	APMX [mm]	3.0	APMX [mm]	4.0	APMX [mm]	8.9 – 44.7	APMX [mm]	8,0 – 16.0												
	DCX [mm]	15 – 25	DCX [mm]	20 – 52	DCX [mm]	24 – 80	DCX [mm]	32 – 100	DCX [mm]	10 – 50	DCX [mm]	16 – 32												
		DCX = 15 [mm]		DCX = 20 [mm]						DCX = 10 – 32 [mm]		DCX = 16 – 32 [mm]												
		DCX = 15 – 25 [mm]		DCX = 20 – 42 [mm]		DCX = 24 – 42 [mm]		DCX = 32 [mm]		DCX = 10 – 32 [mm]		DCX = 16 – 32 [mm]												
				DCX = 42 – 52 [mm]		DCX = 50 – 80 [mm]		DCX = 52 – 100 [mm]																
	📖 545		📖 550		📖 556		📖 562		📖 568		📖 575													
	P	M	K	N	S	H	P	M	K	N	S	H	P	M	K	N	S	H	P	M	K	N	S	H
																								
	RD 0702		RD 1003		RD 12T3		RD 1604		ZP		XP													
	-		-		-		-		2		1													
	■		■		■		■		■		■													
	■		■		■		■																	
	■		■		■		■																	
	■		■		■		■																	
	■		■		■		■																	
																								
																								
																								
																								



INDEXABLE MILLS – NAVIGATOR

<<< COPY MILLING >>>













	K2-SRC		K2-SLC		K2-PPH		SVC22C		SWN04C	
	–		90°		–		90°		90° (93°)	
	APMX [mm]	0.6 – 3.2	APMX [mm]	1.0 – 3.0	APMX [mm]	0.3 – 4.0	APMX [mm]	3.0 (16.0)	APMX [mm]	0.5 (2.0)
	DCX [mm]	8 – 20	DCX [mm]	12 – 20	DCX [mm]	8 – 32	DC [mm]	32 – 80	DC [mm]	20 – 35
Cylindrical shank		DCX = 8 – 20 [mm]				DCX = 8 – 32 [mm]		DC = 32 – 40 [mm]		DC = 20 – 32 [mm]
Weldon										
Modular		DCX = 8 – 20 [mm]				DCX = 16 – 20 [mm]		DC = 32 – 40 [mm]		DC = 20 – 35 [mm]
Shell mill								DC = 50 – 80 [mm]		
Page	579		588		592		604		607	
ISO	P	M	K	H	P	M	K	H	S	H
Insert shape										
Inserts	RC LC		LC		PPH PPHF PPHT		VCGT 220530		WN.. 0403	
No. of cutting edges	2		2		2		2		6	
Shape surfaces milling (copy milling) 	■		■		■				■	
Face milling 									■	
Helical interpolation 			☑		☑		■			
Progressive plunging 			☑		☑		■			
Ramping 			☑		☑		☑		■	
Shallow shoulder milling 							☑			
Deep shoulder milling 							☑		■	
Chamfer milling 			☑		☑					
Plunge milling 									■	



INDEXABLE MILLS – NAVIGATOR



COPY MILLING



























SCN05C						
90° (93°)						
APMX [mm]	0.5 (1.0)					
DC [mm]	12 – 20					
	DC = 12 – 20 [mm]					
	DC = 12 – 20 [mm]					
610						
P	K	H				
						
CN.. 0502						
4						
	■					
	■					
						
						
	■					
						
	■					
						
	■					















INDEXABLE MILLS – NAVIGATOR

HIGH FEED MILLING



	SBN10		SSN11		SPD09		SZD07		SZD09														
	20°		18°		19°		-		-														
	APMX [mm]	1.0	APMX [mm]	1.7	APMX [mm]	2.0	APMX [mm]	1.0	APMX [mm]	1.0													
	DCX [mm]	16 – 42	DCX [mm]	32 – 125	DCX [mm]	32 – 140	DCX [mm]	16 – 32	DCX [mm]	25 – 66													
Cylindrical shank		DCX = 16 – 35 [mm]		DCX = 32 – 35 [mm]		DCX = 32 – 40 [mm]		DCX = 16 – 25 [mm]															
Weldon										DCX = 25 – 32 [mm]													
Modular		DCX = 16 – 40 [mm]		DCX = 32 – 40 [mm]				DCX = 16 – 32 [mm]		DCX = 25 – 42 [mm]													
Shell mill		DCX = 40 – 42 [mm]		DCX = 40 – 125 [mm]		DCX = 42 – 140 [mm]				DCX = 40 – 66 [mm]													
Page	616		622		627		633		637														
ISO	P	M	K	S	H	P	M	K	S		P	M	K	S	H	P	K		H	P	K		H
Insert shape																							
Inserts	BNGX 10T3 ANHX 10T3		SNGX 1104		PD.. 0905		ZDCW 0703		ZDCW 09T3														
No. of cutting edges	4/2		8		5		4		4														
Face milling 	■		■		■		■		■														
Helical interpolation 	■		▣		■		▣		▣														
Shallow shoulder milling 	■		■		■		▣		▣														
Plunge milling 	■		■		■		▣		▣														
Progressive plunging 	■		▣		■		▣		▣														
Ramping 	■		▣		■																		
Shape surfaces milling (copy milling) 	■		■		▣		▣		▣														
Shallow slot milling 	▣		▣		▣		▣		▣														



















SZD12									
-									
APMX [mm]	1.6								
DCX [mm]	32 – 80								
		DCX = 40 [mm]							
		DCX = 32 – 40 [mm]							
		DCX = 50 – 80 [mm]							
 641									
P	K	H							
									
ZDEW 1204									
4									
	■								
	▣								
	▣								
	▣								
	▣								
									
	▣								
	▣								









INDEXABLE MILLS – NAVIGATOR

CHAMFER, T-SLOT MILLING



	SSD09		N-SSO09		2516		2636		J(T)-SXP16								
	45°		45°		45°		10°–80°		15°–75°								
	APMX [mm]	4.5	APMX [mm]	4.5	APMX [mm]	8.5	APMX [mm]	8.5	APMX [mm]	7.0–28.0							
	DC [mm]	10–25	DC [mm]	8–25	DC [mm]	11–19	DC [mm]	5–23	DC [mm]	35–45							
Cylindrical shank			DC = 16–25 [mm]														
Weldon			DC = 10–25 [mm]														
Morse			DC = 10–25 [mm]														
Shell mill																	
Page	648		651		654		657		660								
ISO	P	M	K	S	H	P	M	K	S	P	M	K	S	P	M	K	N
Insert shape																	
Inserts	SDE. 0903		SOMT 09T3		TCMT 16T3		TCMT 16T3		XPHT 1604								
No. of cutting edges	4		4		3		3		2								
Chamfer milling 	■		■		■		■		■								
Rear face milling 																	
T-slot milling 																	
Shallow shoulder milling 																	
Shallow slot milling 																	



F-SCC									
90°									
APMX [mm]	11.0 – 18.0								
DC [mm]	25 – 40								
									
664									
P	M	K							
									
CCMX									
2									
									
	■								
	■								
	▣								
	▣								



ISO CODE DESIGNATION – SHELL MILL BODIES

ISO	1 63	2 A	3 06	4 R	-	5	6 S	7 90	8 A	9 D	10 16	11 E	12
ANSI	1 300	2 F	3 04	4 N	-	5 I	6 S	7 90	8 S	9 N	10 12	11 N	12 4

1	1	2	2	3	3	5	6	6	7	7				
Cutting diameter		Cutting type, designation and/or size of clamping			No. of working edges		Standard		Clamping designation		Setting angle [KAPR]			
													A ISO 6462/A DIN 8030/A B ISO 6462/B DIN 8030/B C ISO 6462/C DIN 8030/C	
		F DC = 27 mm DC = 1.000 G DC = 32 mm DC = 1.250 H DC = 40 mm - J DC = 50 mm - K DC = 60 mm - M DC = 80 mm -											4 4 Direction of cut	
		T												

8	8	9	9	10	10																																																																																																																																																																																																												
Insert shape				Insert clearance angle		Cutting edge length																																																																																																																																																																																																											
						<table border="1" style="width: 100%; border-collapse: collapse; text-align: center;"> <thead> <tr> <th rowspan="2">[mm]</th> <th rowspan="2">["]</th> <th>IC</th> <th>H</th> <th>O</th> <th>P</th> <th>S</th> <th>T</th> <th>C</th> <th>D</th> <th>E</th> <th>M</th> <th>V</th> <th>W</th> <th>R</th> <th>K</th> </tr> </thead> <tbody> <tr> <td>3,97</td> <td>5/32"</td> <td></td> <td></td> <td></td> <td>03</td> <td>06</td> <td></td> <td>04</td> <td></td> <td></td> <td></td> <td>06</td> <td>02</td> <td></td> <td></td> </tr> <tr> <td>4,76</td> <td>3/16"</td> <td></td> <td></td> <td></td> <td>04</td> <td>08</td> <td>04</td> <td>05</td> <td>04</td> <td>04</td> <td>08</td> <td>L3</td> <td></td> <td></td> <td></td> </tr> <tr> <td>5,56</td> <td>7/32"</td> <td></td> <td></td> <td></td> <td>05</td> <td>09</td> <td>05</td> <td>06</td> <td>05</td> <td>05</td> <td>09</td> <td>03</td> <td></td> <td></td> <td></td> </tr> <tr> <td>6,35</td> <td>1/4"</td> <td>03</td> <td>02</td> <td>04</td> <td>08</td> <td>11</td> <td>06</td> <td>07</td> <td>08</td> <td>08</td> <td>11</td> <td>04</td> <td>06</td> <td></td> <td></td> </tr> <tr> <td>7,94</td> <td>5/16"</td> <td>04</td> <td>03</td> <td>05</td> <td>07</td> <td>13</td> <td>08</td> <td>09</td> <td>06</td> <td>07</td> <td>13</td> <td>05</td> <td>07</td> <td></td> <td></td> </tr> <tr> <td>9,525</td> <td>3/8"</td> <td>05</td> <td>04</td> <td>07</td> <td>09</td> <td>16</td> <td>09</td> <td>11</td> <td>09</td> <td>09</td> <td>16</td> <td>06</td> <td>09</td> <td>19</td> <td></td> </tr> <tr> <td>12,7</td> <td>1/2"</td> <td>07</td> <td>05</td> <td>09</td> <td>12</td> <td>22</td> <td>12</td> <td>15</td> <td>13</td> <td>12</td> <td>22</td> <td>08</td> <td>12</td> <td></td> <td></td> </tr> <tr> <td>15,875</td> <td>5/8"</td> <td>09</td> <td>06</td> <td>11</td> <td>15</td> <td>27</td> <td>16</td> <td>19</td> <td>16</td> <td>15</td> <td>27</td> <td>10</td> <td>15</td> <td></td> <td></td> </tr> <tr> <td>19,05</td> <td>3/4"</td> <td>11</td> <td>07</td> <td>13</td> <td>19</td> <td>33</td> <td>19</td> <td>23</td> <td>19</td> <td>19</td> <td>33</td> <td>13</td> <td>19</td> <td></td> <td></td> </tr> <tr> <td>25,4</td> <td>5/1"</td> <td>14</td> <td>10</td> <td>18</td> <td>25</td> <td>44</td> <td>25</td> <td>31</td> <td>26</td> <td>25</td> <td>44</td> <td>17</td> <td>25</td> <td></td> <td></td> </tr> <tr> <td>31,75</td> <td>1 1/4"</td> <td>18</td> <td>13</td> <td>23</td> <td>31</td> <td>54</td> <td>32</td> <td>38</td> <td>32</td> <td>31</td> <td>54</td> <td>21</td> <td>31</td> <td></td> <td></td> </tr> </tbody> </table>												[mm]	["]	IC	H	O	P	S	T	C	D	E	M	V	W	R	K	3,97	5/32"				03	06		04				06	02			4,76	3/16"				04	08	04	05	04	04	08	L3				5,56	7/32"				05	09	05	06	05	05	09	03				6,35	1/4"	03	02	04	08	11	06	07	08	08	11	04	06			7,94	5/16"	04	03	05	07	13	08	09	06	07	13	05	07			9,525	3/8"	05	04	07	09	16	09	11	09	09	16	06	09	19		12,7	1/2"	07	05	09	12	22	12	15	13	12	22	08	12			15,875	5/8"	09	06	11	15	27	16	19	16	15	27	10	15			19,05	3/4"	11	07	13	19	33	19	23	19	19	33	13	19			25,4	5/1"	14	10	18	25	44	25	31	26	25	44	17	25			31,75	1 1/4"	18	13	23	31	54	32	38	32	31	54	21	31		
[mm]	["]	IC	H	O	P	S	T	C	D	E	M	V	W	R	K																																																																																																																																																																																																		
		3,97	5/32"				03	06		04				06	02																																																																																																																																																																																																		
4,76	3/16"				04	08	04	05	04	04	08	L3																																																																																																																																																																																																					
5,56	7/32"				05	09	05	06	05	05	09	03																																																																																																																																																																																																					
6,35	1/4"	03	02	04	08	11	06	07	08	08	11	04	06																																																																																																																																																																																																				
7,94	5/16"	04	03	05	07	13	08	09	06	07	13	05	07																																																																																																																																																																																																				
9,525	3/8"	05	04	07	09	16	09	11	09	09	16	06	09	19																																																																																																																																																																																																			
12,7	1/2"	07	05	09	12	22	12	15	13	12	22	08	12																																																																																																																																																																																																				
15,875	5/8"	09	06	11	15	27	16	19	16	15	27	10	15																																																																																																																																																																																																				
19,05	3/4"	11	07	13	19	33	19	23	19	19	33	13	19																																																																																																																																																																																																				
25,4	5/1"	14	10	18	25	44	25	31	26	25	44	17	25																																																																																																																																																																																																				
31,75	1 1/4"	18	13	23	31	54	32	38	32	31	54	21	31																																																																																																																																																																																																				

11	11
Wiper edge clearance angle	
N ALP = 0°	C ALP = 7°
D ALP = 15°	E ALP = 20°
P ALP = 11°	F ALP = 25°

12	12												
Cutting edge length (width)													
<table border="1" style="width: 100%; border-collapse: collapse; text-align: center;"> <thead> <tr> <th>CW [mm]</th> <th>["]</th> </tr> </thead> <tbody> <tr> <td>0.156</td> <td>2.5</td> </tr> <tr> <td>0.187</td> <td>3</td> </tr> <tr> <td>0.250</td> <td>4</td> </tr> <tr> <td>0.313</td> <td>5</td> </tr> <tr> <td>0.375</td> <td>6</td> </tr> </tbody> </table>		CW [mm]	["]	0.156	2.5	0.187	3	0.250	4	0.313	5	0.375	6
CW [mm]	["]												
0.156	2.5												
0.187	3												
0.250	4												
0.313	5												
0.375	6												



ISO CODE DESIGNATION – END SHOULDER MILL BODIES

ISO	1	2	3	4	5	6	7	-	8	9	10	11	12	13
ANSI	1	2	3	4	5	6	7	-	8	9	10	11	12	13
32	A	4	R	042	B	32	-		S	A	D	11	11	E
125	A	4	R	150	W	125	-	I	S	A	D	11	11	E

1	1	2	2	5	5	6	6	7	7						
Cutting diameter		Cutter type and setting angle				Overhang		Shank designation		Shank size					
 DC		A 	E 	J 	N 	H 	K 	[mm] ["]		A	C	DIN 1835A	6 – 40 mm	.250" – 1.250"	
 DC		No. of working edges				Direction of cut			B		W		ISO 3338-2, DIN 1835B	6 – 50 mm	.375" – 2.000"
 DC		3 3		4 4			R 		L 		N 		ISO 296, DIN 228-1	1 – 6	–
 DC		3 3		4 4			R8 		R8 		R8		40 – 50 mm	–	
 DCX		3 3		4 4			X 		X 		MAS BT		30 – 50 mm	–	
 DCX		3 3		4 4			XC 		XC 		CAPTO		3 – 10 mm	–	
 DCX		3 3		4 4			CA 		CA 		ANSI B5.50		–	40 / 50	

8	8	9	9	10	10																																																																																																																																																																																																	
Insert shape		Insert clearance angle		Cutting edge length																																																																																																																																																																																																		
H 	O 	P 	R 	A 3° 	B 5° 																																																																																																																																																																																																	
S 	T 	C 80° 	D 55° 	C 7° 	D 15° 																																																																																																																																																																																																	
E 75° 	M 86° 	V 35° 	W 80° 	E 20° 	F 25° 																																																																																																																																																																																																	
L 	A 85° 	B 82° 	K 55° 	G 30° 	N 0° 																																																																																																																																																																																																	
				P 11° 	O Special																																																																																																																																																																																																	
<table border="1" style="width: 100%; border-collapse: collapse;"> <thead> <tr> <th style="width: 10%;"></th> <th style="width: 10%;">IC</th> <th style="width: 10%;">H</th> <th style="width: 10%;">O</th> <th style="width: 10%;">P</th> <th style="width: 10%;">S</th> <th style="width: 10%;">T</th> <th style="width: 10%;">C</th> <th style="width: 10%;">D</th> <th style="width: 10%;">E</th> <th style="width: 10%;">M</th> <th style="width: 10%;">V</th> <th style="width: 10%;">W</th> <th style="width: 10%;">R</th> <th style="width: 10%;">K</th> </tr> </thead> <tbody> <tr> <td style="text-align: center;">3,97</td> <td></td> <td></td> <td></td> <td></td> <td></td> <td></td> <td></td> <td></td> <td></td> <td></td> <td></td> <td></td> <td></td> <td></td> </tr> <tr> <td style="text-align: center;">4,76</td> <td style="text-align: center;">5/32"</td> <td></td> <td></td> <td></td> <td>03</td> <td>06</td> <td></td> <td>04</td> <td></td> <td></td> <td>06</td> <td>02</td> <td></td> <td></td> </tr> <tr> <td style="text-align: center;">5,56</td> <td style="text-align: center;">3/16"</td> <td></td> <td></td> <td></td> <td>04</td> <td>08</td> <td>04</td> <td>05</td> <td>04</td> <td>04</td> <td>08</td> <td>L3</td> <td></td> <td></td> </tr> <tr> <td style="text-align: center;">6,35</td> <td style="text-align: center;">7/32"</td> <td></td> <td></td> <td></td> <td>05</td> <td>09</td> <td>05</td> <td>06</td> <td>05</td> <td>05</td> <td>09</td> <td>03</td> <td></td> <td></td> </tr> <tr> <td style="text-align: center;">7,94</td> <td style="text-align: center;">1/4"</td> <td>03</td> <td>02</td> <td>04</td> <td>08</td> <td>11</td> <td>06</td> <td>07</td> <td>08</td> <td>08</td> <td>11</td> <td>04</td> <td>06</td> <td></td> </tr> <tr> <td style="text-align: center;">9,525</td> <td style="text-align: center;">5/16"</td> <td>05</td> <td>04</td> <td>07</td> <td>09</td> <td>16</td> <td>09</td> <td>11</td> <td>09</td> <td>09</td> <td>16</td> <td>06</td> <td>09</td> <td>19</td> </tr> <tr> <td style="text-align: center;">12,7</td> <td style="text-align: center;">3/8"</td> <td>07</td> <td>05</td> <td>09</td> <td>12</td> <td>22</td> <td>12</td> <td>15</td> <td>13</td> <td>12</td> <td>22</td> <td>08</td> <td>12</td> <td></td> </tr> <tr> <td style="text-align: center;">15,875</td> <td style="text-align: center;">1/2"</td> <td>09</td> <td>06</td> <td>11</td> <td>15</td> <td>27</td> <td>16</td> <td>19</td> <td>16</td> <td>15</td> <td>27</td> <td>10</td> <td>15</td> <td></td> </tr> <tr> <td style="text-align: center;">19,05</td> <td style="text-align: center;">5/8"</td> <td>11</td> <td>07</td> <td>13</td> <td>19</td> <td>33</td> <td>19</td> <td>23</td> <td>19</td> <td>19</td> <td>33</td> <td>13</td> <td>19</td> <td></td> </tr> <tr> <td style="text-align: center;">25,4</td> <td style="text-align: center;">3/4"</td> <td>14</td> <td>10</td> <td>18</td> <td>25</td> <td>44</td> <td>25</td> <td>31</td> <td>26</td> <td>25</td> <td>44</td> <td>17</td> <td>25</td> <td></td> </tr> <tr> <td style="text-align: center;">31,75</td> <td style="text-align: center;">5/1"</td> <td>18</td> <td>13</td> <td>23</td> <td>31</td> <td>54</td> <td>32</td> <td>38</td> <td>32</td> <td>31</td> <td>54</td> <td>21</td> <td>31</td> <td></td> </tr> <tr> <td></td> <td style="text-align: center;">1 1/4"</td> <td></td> <td></td> <td></td> <td></td> <td></td> <td></td> <td>10"</td> <td></td> <td></td> <td></td> <td></td> <td></td> <td></td> </tr> </tbody> </table>			IC	H	O	P	S	T	C	D	E	M	V	W	R	K	3,97															4,76	5/32"				03	06		04			06	02			5,56	3/16"				04	08	04	05	04	04	08	L3			6,35	7/32"				05	09	05	06	05	05	09	03			7,94	1/4"	03	02	04	08	11	06	07	08	08	11	04	06		9,525	5/16"	05	04	07	09	16	09	11	09	09	16	06	09	19	12,7	3/8"	07	05	09	12	22	12	15	13	12	22	08	12		15,875	1/2"	09	06	11	15	27	16	19	16	15	27	10	15		19,05	5/8"	11	07	13	19	33	19	23	19	19	33	13	19		25,4	3/4"	14	10	18	25	44	25	31	26	25	44	17	25		31,75	5/1"	18	13	23	31	54	32	38	32	31	54	21	31			1 1/4"							10"								
	IC	H	O	P	S	T	C	D	E	M	V	W	R	K																																																																																																																																																																																								
3,97																																																																																																																																																																																																						
4,76	5/32"				03	06		04			06	02																																																																																																																																																																																										
5,56	3/16"				04	08	04	05	04	04	08	L3																																																																																																																																																																																										
6,35	7/32"				05	09	05	06	05	05	09	03																																																																																																																																																																																										
7,94	1/4"	03	02	04	08	11	06	07	08	08	11	04	06																																																																																																																																																																																									
9,525	5/16"	05	04	07	09	16	09	11	09	09	16	06	09	19																																																																																																																																																																																								
12,7	3/8"	07	05	09	12	22	12	15	13	12	22	08	12																																																																																																																																																																																									
15,875	1/2"	09	06	11	15	27	16	19	16	15	27	10	15																																																																																																																																																																																									
19,05	5/8"	11	07	13	19	33	19	23	19	19	33	13	19																																																																																																																																																																																									
25,4	3/4"	14	10	18	25	44	25	31	26	25	44	17	25																																																																																																																																																																																									
31,75	5/1"	18	13	23	31	54	32	38	32	31	54	21	31																																																																																																																																																																																									
	1 1/4"							10"																																																																																																																																																																																														

8	9	9	13	13
Standard		Clamping designation		Wiper edge clearance angle
I	["]			
C 	W 	S 	F 	N ALP = 0° C ALP = 7° P ALP = 11° D ALP = 15° E ALP = 20° F ALP = 25°



ISO CODE DESIGNATION – MILLING INSERTS

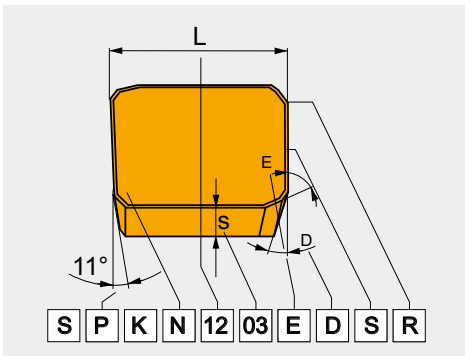

ISO	1	2	3	4
	S	P	G	N
ANSI	1	2	3	4
	S	P	G	N

1				2				4														
Insert shape				Insert clearance angle				Insert type														
H	O	P	R	A	B	C	D	N	R	F	A	M	G	W	T	Q	U	B	H	C	J	X
										Special		Special		Special		Special		Special		Special		
S	T	C	D	E	F	G	N															
E	M	V	W	P	O																	
					Special																	
L	A	B	K																			

Tolerances

	[mm]			["]		
	M (±)	S (±)	IC (±)	M (±)	S (±)	IC (±)
A	0.005	0.025	0.025	0.0002"	0.001"	0.0010"
F	0.005	0.025	0.013	0.0002"	0.001"	0.0005"
C	0.013	0.025	0.025	0.0005"	0.001"	0.0010"
H	0.013	0.025	0.013	0.0005"	0.001"	0.0005"
E	0.025	0.025	0.025	0.0010"	0.001"	0.0010"
G	0.025	0.130	0.025	0.0010"	0.005"	0.0010"
J	0.005	0.025	0.05 – 0.13	0.0002"	0.001"	0.002" – 0.005"
K	0.013	0.025	0.05 – 0.13	0.0005"	0.001"	0.002" – 0.005"
L	0.025	0.025	0.05 – 0.13	0.0010"	0.001"	0.002" – 0.005"
M	0.08 – 0.18	0.130	0.05 – 0.13	0.003" – 0.007"	0.005"	0.002" – 0.005"
N	0.08 – 0.18	0.025	0.05 – 0.13	0.003" – 0.007"	0.001"	0.002" – 0.005"
U	0.05 – 0.38	0.130	0.05 – 0.13	0.005" – 0.015"	0.005"	0.003" – 0.010"

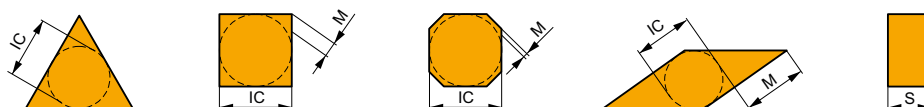



ISO CODE DESIGNATION – MILLING INSERTS

5		6		7		8		9		10	
12	12	03	03	08	ED	S	R	-			
5a	6a	7a	8	9							
4	2	2	S	R	-						
4	2	ED									

5		5												
Cutting edge length														
I.C.	H	O	P	S	T	C	D	E	M	V	W	R	K	
[mm]	["]													
3.97				03	06		04				06	02		
	5/32"						1.2"							
4.76				04	08	04	05	04	04	08	L3			
	3/16"						1.5"							
5.56				05	09	05	06	05	05	09	03			
	7/32"						1.8"							
6.35		03	02	04	08	11	06	07	08	08	11	04	06	
	1/4"						2"							
7.94		04	03	05	07	13	08	09	06	07	13	05	07	
	5/16"						2.5"							
9.525		05	04	07	09	16	09	11	09	09	16	06	09	
	3/8"						3"							
12.7		07	05	09	12	22	12	15	13	12	22	08	12	
	1/2"						4"							
15.875		09	06	11	15	27	16	19	16	15	27	10	15	
	5/8"						5"							
19.05		11	07	13	19	33	19	23	19	19	33	13	19	
	3/4"						6"							
25.4		14	10	18	25	44	25	31	26	25	44	17	25	
	5/1"						8"							
31.75		18	13	23	31	54	32	38	32	31	54	21	31	
	1 1/4"						10"							

6		7																																																																																				
Thickness		Cutting edge angles																																																																																				
<table border="1"> <thead> <tr> <th rowspan="2">Symbol</th> <th colspan="2">S</th> </tr> <tr> <th>[mm]</th> <th>["]</th> </tr> </thead> <tbody> <tr><td>01</td><td>1.59</td><td>1/16"</td></tr> <tr><td>T1</td><td>1.98</td><td>5/64"</td></tr> <tr><td>02</td><td>2.38</td><td>3/32"</td></tr> <tr><td>03</td><td>3.18</td><td>1/8"</td></tr> <tr><td>T3</td><td>3.97</td><td>5/32"</td></tr> <tr><td>04</td><td>4.76</td><td>3/16"</td></tr> <tr><td>05</td><td>5.56</td><td>7/32"</td></tr> <tr><td>06</td><td>6.35</td><td>1/4"</td></tr> <tr><td>07</td><td>7.94</td><td>5/16"</td></tr> <tr><td>09</td><td>9.52</td><td>3/8"</td></tr> </tbody> </table>		Symbol	S		[mm]	["]	01	1.59	1/16"	T1	1.98	5/64"	02	2.38	3/32"	03	3.18	1/8"	T3	3.97	5/32"	04	4.76	3/16"	05	5.56	7/32"	06	6.35	1/4"	07	7.94	5/16"	09	9.52	3/8"	<table border="1"> <thead> <tr> <th rowspan="2"></th> <th colspan="2">KAPR</th> <th colspan="2">ALP</th> </tr> <tr> <th>Symbol</th> <th>Angle</th> <th>Symbol</th> <th>Angle</th> </tr> </thead> <tbody> <tr><td>A</td><td>45°</td><td>A</td><td>3°</td></tr> <tr><td>D</td><td>60°</td><td>B</td><td>5°</td></tr> <tr><td>E</td><td>75°</td><td>C</td><td>7°</td></tr> <tr><td>F</td><td>85°</td><td>D</td><td>15°</td></tr> <tr><td>P</td><td>90°</td><td>E</td><td>20°</td></tr> <tr><td rowspan="3">Z</td><td rowspan="3">Special</td><td>F</td><td>25°</td></tr> <tr><td>G</td><td>30°</td></tr> <tr><td>N</td><td>0°</td></tr> <tr><td rowspan="2">Z</td><td rowspan="2">Special</td><td>P</td><td>11°</td></tr> <tr><td>Z</td><td>Special</td></tr> <tr><td colspan="5">ZZ – Special</td></tr> </tbody> </table>			KAPR		ALP		Symbol	Angle	Symbol	Angle	A	45°	A	3°	D	60°	B	5°	E	75°	C	7°	F	85°	D	15°	P	90°	E	20°	Z	Special	F	25°	G	30°	N	0°	Z	Special	P	11°	Z	Special	ZZ – Special				
Symbol	S																																																																																					
	[mm]	["]																																																																																				
01	1.59	1/16"																																																																																				
T1	1.98	5/64"																																																																																				
02	2.38	3/32"																																																																																				
03	3.18	1/8"																																																																																				
T3	3.97	5/32"																																																																																				
04	4.76	3/16"																																																																																				
05	5.56	7/32"																																																																																				
06	6.35	1/4"																																																																																				
07	7.94	5/16"																																																																																				
09	9.52	3/8"																																																																																				
	KAPR		ALP																																																																																			
	Symbol	Angle	Symbol	Angle																																																																																		
A	45°	A	3°																																																																																			
D	60°	B	5°																																																																																			
E	75°	C	7°																																																																																			
F	85°	D	15°																																																																																			
P	90°	E	20°																																																																																			
Z	Special	F	25°																																																																																			
		G	30°																																																																																			
		N	0°																																																																																			
Z	Special	P	11°																																																																																			
		Z	Special																																																																																			
ZZ – Special																																																																																						

ANSI																																																																																																			
5a			6a			7a			RE																																																																																										
Inscribed circle			Thickness			Corner radius			Symbol																																																																																										
									<table border="1"> <thead> <tr> <th>Symbol</th> <th>[mm]</th> <th>["]</th> </tr> </thead> <tbody> <tr><td>0</td><td>0</td><td>0"</td></tr> <tr><td>0.2</td><td>0.099</td><td>1/256"</td></tr> <tr><td>0.5</td><td>0.198</td><td>1/128"</td></tr> <tr><td>1</td><td>0.397</td><td>1/64"</td></tr> <tr><td>2</td><td>0.794</td><td>1/32"</td></tr> <tr><td>3</td><td>1.191</td><td>3/64"</td></tr> <tr><td>4</td><td>1.588</td><td>1/16"</td></tr> <tr><td>5</td><td>1.984</td><td>5/64"</td></tr> <tr><td>6</td><td>2.381</td><td>3/32"</td></tr> <tr><td>7</td><td>2.778</td><td>7/64"</td></tr> <tr><td>8</td><td>3.175</td><td>1/8"</td></tr> <tr><td>10</td><td>3.969</td><td>5/32"</td></tr> <tr><td>12</td><td>4.763</td><td>3/16"</td></tr> <tr><td>14</td><td>5.556</td><td>7/32"</td></tr> <tr><td>16</td><td>6.350</td><td>1/4"</td></tr> </tbody> </table>			Symbol	[mm]	["]	0	0	0"	0.2	0.099	1/256"	0.5	0.198	1/128"	1	0.397	1/64"	2	0.794	1/32"	3	1.191	3/64"	4	1.588	1/16"	5	1.984	5/64"	6	2.381	3/32"	7	2.778	7/64"	8	3.175	1/8"	10	3.969	5/32"	12	4.763	3/16"	14	5.556	7/32"	16	6.350	1/4"																																								
Symbol	[mm]	["]																																																																																																	
0	0	0"																																																																																																	
0.2	0.099	1/256"																																																																																																	
0.5	0.198	1/128"																																																																																																	
1	0.397	1/64"																																																																																																	
2	0.794	1/32"																																																																																																	
3	1.191	3/64"																																																																																																	
4	1.588	1/16"																																																																																																	
5	1.984	5/64"																																																																																																	
6	2.381	3/32"																																																																																																	
7	2.778	7/64"																																																																																																	
8	3.175	1/8"																																																																																																	
10	3.969	5/32"																																																																																																	
12	4.763	3/16"																																																																																																	
14	5.556	7/32"																																																																																																	
16	6.350	1/4"																																																																																																	
<table border="1"> <thead> <tr> <th rowspan="2">Symbol</th> <th colspan="2">I.C.</th> </tr> <tr> <th>[mm]</th> <th>["]</th> </tr> </thead> <tbody> <tr><td>1</td><td>3.175</td><td>1/8"</td></tr> <tr><td>1.2</td><td>3.969</td><td>5/32"</td></tr> <tr><td>1.5</td><td>4.763</td><td>3/16"</td></tr> <tr><td>1.8</td><td>5.556</td><td>7/32"</td></tr> <tr><td>2</td><td>6.350</td><td>1/4"</td></tr> <tr><td>2.5</td><td>7.938</td><td>5/16"</td></tr> <tr><td>3</td><td>9.525</td><td>3/8"</td></tr> <tr><td>4</td><td>12.700</td><td>1/2"</td></tr> <tr><td>5</td><td>15.875</td><td>5/8"</td></tr> <tr><td>6</td><td>19.050</td><td>3/4"</td></tr> <tr><td>7</td><td>22.225</td><td>7/8"</td></tr> <tr><td>8</td><td>25.400</td><td>1"</td></tr> <tr><td>10</td><td>31.750</td><td>5/4"</td></tr> <tr><td>12</td><td>38.100</td><td>6/4"</td></tr> </tbody> </table>			Symbol	I.C.		[mm]	["]	1	3.175	1/8"	1.2	3.969	5/32"	1.5	4.763	3/16"	1.8	5.556	7/32"	2	6.350	1/4"	2.5	7.938	5/16"	3	9.525	3/8"	4	12.700	1/2"	5	15.875	5/8"	6	19.050	3/4"	7	22.225	7/8"	8	25.400	1"	10	31.750	5/4"	12	38.100	6/4"	<table border="1"> <thead> <tr> <th rowspan="2">Symbol</th> <th colspan="2">S</th> </tr> <tr> <th>[mm]</th> <th>["]</th> </tr> </thead> <tbody> <tr><td>1</td><td>1.588</td><td>1/16"</td></tr> <tr><td>1.2</td><td>1.984</td><td>5/64"</td></tr> <tr><td>1.5</td><td>2.381</td><td>3/32"</td></tr> <tr><td>2</td><td>3.175</td><td>1/8"</td></tr> <tr><td>2.5</td><td>3.969</td><td>5/32"</td></tr> <tr><td>3</td><td>4.763</td><td>3/16"</td></tr> <tr><td>3.5</td><td>5.556</td><td>7/32"</td></tr> <tr><td>4</td><td>6.350</td><td>1/4"</td></tr> <tr><td>5</td><td>7.938</td><td>5/16"</td></tr> <tr><td>6</td><td>9.525</td><td>3/8"</td></tr> <tr><td>7</td><td>11.113</td><td>7/16"</td></tr> <tr><td>8</td><td>12.700</td><td>1/2"</td></tr> <tr><td>9</td><td>14.288</td><td>9/16"</td></tr> <tr><td>10</td><td>15.875</td><td>5/8"</td></tr> </tbody> </table>			Symbol	S		[mm]	["]	1	1.588	1/16"	1.2	1.984	5/64"	1.5	2.381	3/32"	2	3.175	1/8"	2.5	3.969	5/32"	3	4.763	3/16"	3.5	5.556	7/32"	4	6.350	1/4"	5	7.938	5/16"	6	9.525	3/8"	7	11.113	7/16"	8	12.700	1/2"	9	14.288	9/16"	10	15.875	5/8"
Symbol	I.C.																																																																																																		
	[mm]	["]																																																																																																	
1	3.175	1/8"																																																																																																	
1.2	3.969	5/32"																																																																																																	
1.5	4.763	3/16"																																																																																																	
1.8	5.556	7/32"																																																																																																	
2	6.350	1/4"																																																																																																	
2.5	7.938	5/16"																																																																																																	
3	9.525	3/8"																																																																																																	
4	12.700	1/2"																																																																																																	
5	15.875	5/8"																																																																																																	
6	19.050	3/4"																																																																																																	
7	22.225	7/8"																																																																																																	
8	25.400	1"																																																																																																	
10	31.750	5/4"																																																																																																	
12	38.100	6/4"																																																																																																	
Symbol	S																																																																																																		
	[mm]	["]																																																																																																	
1	1.588	1/16"																																																																																																	
1.2	1.984	5/64"																																																																																																	
1.5	2.381	3/32"																																																																																																	
2	3.175	1/8"																																																																																																	
2.5	3.969	5/32"																																																																																																	
3	4.763	3/16"																																																																																																	
3.5	5.556	7/32"																																																																																																	
4	6.350	1/4"																																																																																																	
5	7.938	5/16"																																																																																																	
6	9.525	3/8"																																																																																																	
7	11.113	7/16"																																																																																																	
8	12.700	1/2"																																																																																																	
9	14.288	9/16"																																																																																																	
10	15.875	5/8"																																																																																																	

8		8	
Cutting edge design			
	Sharp edges		Rounded edges
	Edges with facet		Rounded edges with facet
	Edges with double facet		Rounded edges with double facet

9		9	
Feed direction			

10		10	
Chip breaker design			



DORMER PRAMET



ALL IN ONE

All our publications in one place, tailored to your location and updated with the latest versions. What are you waiting for? Download our library app today from your relevant app store. **Simply Reliable.**

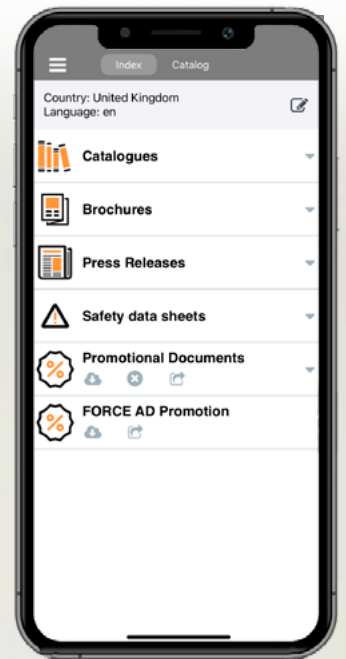
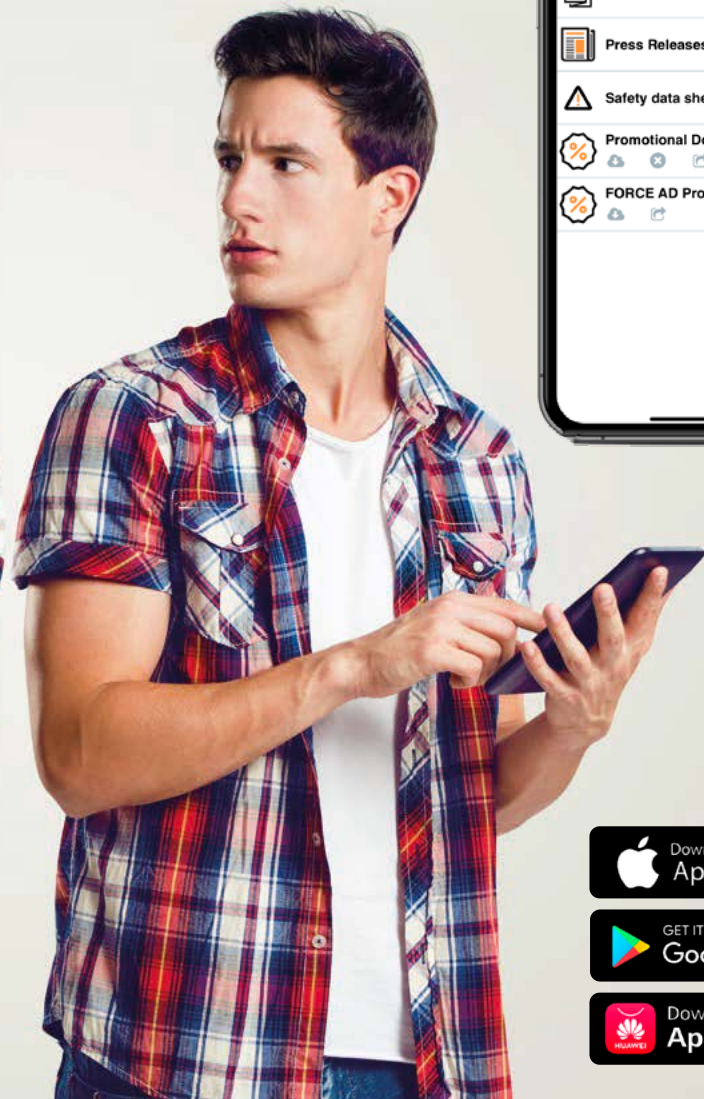





















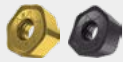

INDEXABLE FACE MILLS



INDEXABLE FACE MILLS – NAVIGATOR

FACE MILLING





























	SHN06C		SHN09C		SOD05		SOD06D		SOE06Z														
	45°		45°		45°		45°		43°														
	APMX [mm]	3.0	APMX [mm]	5.0	APMX [mm]	2.7 (10.0)	APMX [mm]	3.1 (8, 6)	APMX [mm]	3.3 (9.9)													
	DC [mm]	25 – 125	DC [mm]	50 – 315	DCX [mm]	32 – 125	DC [mm]	63 – 160	DC [mm]	50 – 200													
Cylindrical shank							DCX = 32 – 40 [mm]																
Weldon			DC = 25 – 32 [mm]																				
Modular			DC = 25 – 40 [mm]																				
Shell mill																							
	DC = 40 – 125 [mm]				DCX = 40 – 125 [mm]																		
Page	352		356		360		370		376														
ISO	P	M	K		H	P	M	K		H	P	M	K	N	P	M	K	S	H	P	M	N	S
Insert shape																							
Inserts	HNGX 0604 XNGX 0604		HNGX 0906 XNGX 0906		OD.. 0505 RD.. 1205 SD.. 1205		OD.. 0605 RPE. 1505		OEHT 0604 REHT 1604 XEHT 0604														
No. of cutting edges	12 / 1		12 / 1		8 / - / 4		8 / 1 / -		8 / - / 1														
Face milling 	■		■		■		■		■														
Chamfer milling 	■		■		■		■		■														
Helical interpolation 					■				▣														
Progressive plunging 	■		■		■				▣														
Ramping 	■		■		■				▣														
Shape surfaces milling (copy milling) 					■				▣														
Shallow shoulder milling 					■																		
Shallow slot milling 					■																		
Plunge milling 					■																		



INDEXABLE FACE MILLS – NAVIGATOR



FACE MILLING

	SOE09Z	SSE09	SSN12Z	SPN13	CHN09	FSB22X
	43°	45°	45°	57°	60°	60°
	APMX [mm] 5.0 (14.1)	APMX [mm] 4.5	APMX [mm] 6.5	APMX [mm] 10.0	APMX [mm] 6.0	APMX [mm] 15.0
	DC [mm] 80 – 315	DC [mm] 20 – 160	DC [mm] 50 – 250	DC [mm] 100 – 315	DC [mm] 80 – 125	DC [mm] 125 – 315
			DC = 20 – 32 [mm]			
			DC = 32 – 160 [mm]			
						
	P M N S	P M K S	P M K S	P M K S H	K	P M K
						
	OEHT 0906 REHT 2406 XEHT 0906	SE.T 09T3	SN.T 1205	PNM. 1308 XN.. 1308	HN.. 0905	SB.. 2207
	8 / - / 1	4	4	10 / 1	12	4 / 1
	■	■	■	■	■	■
	■	■	■			
	▣					
	▣					
	▣					
	▣					
						
						
						



SHN06C



PRAMET

S



ECON HN06 45° Face Mill with Double Negative Design and Internal Coolant

Highly productive 45° face mill utilising double sided HN..06 style inserts with APMX of 3 mm. Roughing, finishing and chamfering. Economical insert with 12 cutting edges. Differential tooth pitch. Weldon, modular and arbor style available in range from Ø25 up to Ø125 mm. Body treated for longer tool life.

KAPR	45°
APMX	3.0 mm

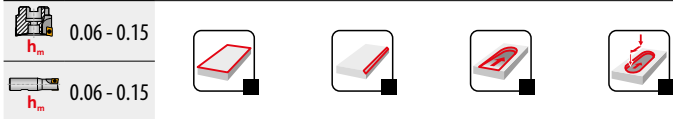
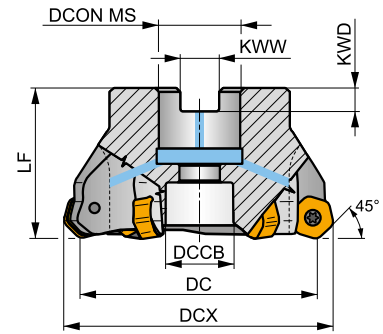
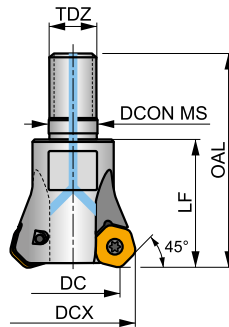
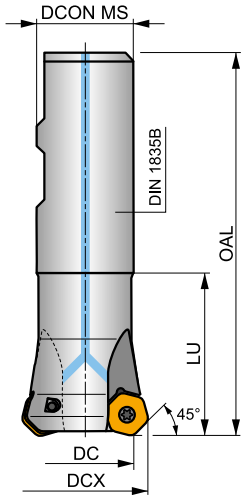
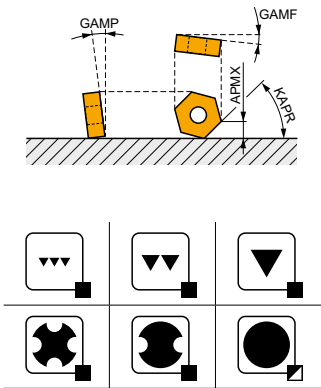

Product	DC	DCX	OAL	DCON MS	DCCB	LU	LF	TDZ	KWW	KWD	GAMF	GAMP	max.	kg	FA010	FA011	FA012	AC001	AC002	AC003
25N2R042B25-SHN06C-C	25	32.2	99	25	-	42	-	-	-	-	-7	-7	2	-	17400	✓	0.36	GI204	FA010	-
32N3R042B32-SHN06C-C	32	39.3	103	32	-	42	-	-	-	-	-7	-7	3	-	15400	✓	0.59	GI204	FA010	-
25N2R033M12-SHN06C-C	25	32.2	56	12.5	-	-	33	M12	-	-	-7	-7	2	-	-	✓	0.11	GI204	FA010	-
32N3R043M16-SHN06C-C	32	39.3	66	17	-	-	43	M16	-	-	-7	-7	3	-	-	✓	0.26	GI204	FA010	-
40N4R043M16-SHN06C-C	40	47.3	66	17	-	-	43	M16	-	-	-7	-7	4	✓	-	✓	0.28	GI204	FA010	-
40A05R-S45HN06C-C	40	47.3	-	16	14	-	40	-	8.4	5.6	-7	-7	5	✓	13800	✓	0.37	GI204	FA012	-
50A04R-S45HN06C-C	50	57.3	-	22	18	-	40	-	10.4	6.3	-7	-7	4	✓	12300	✓	0.62	GI204	FA013	-
50A06R-S45HN06C-C	50	57.3	-	22	18	-	40	-	10.4	6.3	-7	-7	6	✓	12300	✓	0.41	GI204	FA013	-
63A06R-S45HN06C-C	63	70.3	-	22	18	-	40	-	10.4	6.3	-7	-7	6	✓	11000	✓	0.56	GI204	FA013	-
63A08R-S45HN06C-C	63	70.3	-	22	18	-	40	-	10.4	6.3	-7	-7	8	✓	11000	✓	0.69	GI204	FA013	-
80A07R-S45HN06C-C	80	86.8	-	27	38	-	50	-	12.4	7	-7	-7	7	✓	9700	✓	1.10	GI204	FA011	AC001
80A10R-S45HN06C-C	80	86.8	-	27	38	-	50	-	12.4	7	-7	-7	10	✓	9700	✓	0.19	GI204	FA011	AC001
100A08R-S45HN06C-C	100	107.1	-	32	45	-	50	-	14.4	8	-7	-7	8	✓	8700	✓	2.07	GI204	FA011	AC002
100A12R-S45HN06C-C	100	107.1	-	32	45	-	50	-	14.4	8	-7	-7	12	✓	8700	✓	1.82	GI204	FA011	AC002
125A10R-S45HN06C-C	125	132.2	-	40	56	-	63	-	16.4	9	-7	-7	10	✓	7800	✓	3.62	GI204	FA011	AC003
125A16R-S45HN06C-C	125	132.2	-	40	56	-	63	-	16.4	9	-7	-7	16	✓	7800	✓	3.93	GI204	FA011	AC003

GI204	HNGX 0604AN..	XNGX 0604AN..

FA010	US 3007-T09P	2.0	M 3	7.3	-	-	Flag T09P	-
FA011	US 3007-T09P	2.0	M 3	7.3	D-T07P/T09P	FG-15	-	-
FA012	US 3007-T09P	2.0	M 3	7.3	D-T07P/T09P	FG-15	-	HS 0830C



FA013	US 3007-T09P	2.0	M3	7.3	D-T07P/T09P	FG-15	HS 1030C

AC001	KS 1230	K.FMH27
AC002	KS 1635	K.FMH32
AC003	KS 2040	K.FMH40

HNGX 06



	IC	D1	S
	[mm]	[mm]	[mm]
0604	10.500	3.70	4.76

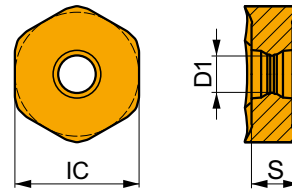

Suitability and starting values for cutting speed (vc), feed (f) and depth of cut (ap). Refer to our Machining Calculator app for further calculations.

Product	RE	P			M			K			N			S			H		
		vc	f	ap	vc	f	ap	vc	f	ap	vc	f	ap	vc	f	ap	vc	f	ap
	[mm]	[m/min]	[mm/tooth]	[mm]	[m/min]	[mm/tooth]	[mm]	[m/min]	[mm/tooth]	[mm]	[m/min]	[mm/tooth]	[mm]	[m/min]	[mm/tooth]	[mm]	[m/min]	[mm/tooth]	[mm]

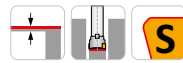
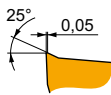

F geometry with highly positive design for light machining.

HNGX 0604ANSN-F		8215	—	■	315	0.11	1.7	▣	185	0.10	1.7	■	—	—	—	—	—	—	—
	M6330	—	■	265	0.11	1.7	▣	185	0.10	1.7	■	—	—	—	—	—	—	—	—
	M8310	—	■	345	0.11	1.7	▣	175	0.10	1.7	■	—	—	—	—	—	—	—	—
	M8330	—	■	305	0.11	1.7	▣	180	0.10	1.7	■	—	—	—	—	—	—	—	—
	M8340	—	■	285	0.11	1.7	▣	170	0.10	1.7	■	—	—	—	—	—	—	—	—
	M9340	—	■	365	0.11	1.7	▣	215	0.10	1.7	■	—	—	—	—	—	—	—	—

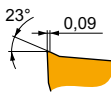

M geometry with highly positive design for medium machining.

HNGX 0604ANSN-M		8215	—	■	300	0.13	2.0	▣	180	0.13	2.0	■	285	0.13	2.0	—	—	—	—
	M5315	—	▣	425	0.13 <td>2.0</td> <td>■</td> <td>—</td> <td>—</td> <td>—</td> <td>■</td> <td>400</td> <td>0.13</td> <td>2.0</td> <td>—</td> <td>—</td> <td>—</td> <td>—</td> <td>—</td>	2.0	■	—	—	—	■	400	0.13	2.0	—	—	—	—	—
	M6330	—	■	255	0.13 <td>2.0</td> <td>▣</td> <td>180</td> <td>0.13 <td>2.0</td> <td>■</td> <td>—</td> <td>—</td> <td>—</td> <td>—</td> <td>—</td> <td>—</td> <td>—</td> <td>—</td> </td>	2.0	▣	180	0.13 <td>2.0</td> <td>■</td> <td>—</td> <td>—</td> <td>—</td> <td>—</td> <td>—</td> <td>—</td> <td>—</td> <td>—</td>	2.0	■	—	—	—	—	—	—	—	—
	M8310	—	■	325	0.13 <td>2.0</td> <td>▣</td> <td>165</td> <td>0.13 <td>2.0</td> <td>■</td> <td>305</td> <td>0.13 <td>2.0</td> <td>—</td> <td>—</td> <td>—</td> <td>—</td> <td>—</td> </td></td>	2.0	▣	165	0.13 <td>2.0</td> <td>■</td> <td>305</td> <td>0.13 <td>2.0</td> <td>—</td> <td>—</td> <td>—</td> <td>—</td> <td>—</td> </td>	2.0	■	305	0.13 <td>2.0</td> <td>—</td> <td>—</td> <td>—</td> <td>—</td> <td>—</td>	2.0	—	—	—	—	—
	M8330	—	■	295	0.13 <td>2.0</td> <td>▣</td> <td>175</td> <td>0.13 <td>2.0</td> <td>■</td> <td>280</td> <td>0.13 <td>2.0</td> <td>—</td> <td>—</td> <td>—</td> <td>—</td> <td>—</td> </td></td>	2.0	▣	175	0.13 <td>2.0</td> <td>■</td> <td>280</td> <td>0.13 <td>2.0</td> <td>—</td> <td>—</td> <td>—</td> <td>—</td> <td>—</td> </td>	2.0	■	280	0.13 <td>2.0</td> <td>—</td> <td>—</td> <td>—</td> <td>—</td> <td>—</td>	2.0	—	—	—	—	—
	M8340	—	■	265	0.13 <td>2.0</td> <td>▣</td> <td>155</td> <td>0.13 <td>2.0</td> <td>■</td> <td>250</td> <td>0.13 <td>2.0</td> <td>—</td> <td>—</td> <td>—</td> <td>—</td> <td>—</td> </td></td>	2.0	▣	155	0.13 <td>2.0</td> <td>■</td> <td>250</td> <td>0.13 <td>2.0</td> <td>—</td> <td>—</td> <td>—</td> <td>—</td> <td>—</td> </td>	2.0	■	250	0.13 <td>2.0</td> <td>—</td> <td>—</td> <td>—</td> <td>—</td> <td>—</td>	2.0	—	—	—	—	—
	M9315	—	■	410	0.13 <td>2.0</td> <td>▣</td> <td>—</td> <td>—</td> <td>—</td> <td>■</td> <td>385</td> <td>0.13 <td>2.0</td> <td>—</td> <td>—</td> <td>—</td> <td>—</td> <td>—</td> </td>	2.0	▣	—	—	—	■	385	0.13 <td>2.0</td> <td>—</td> <td>—</td> <td>—</td> <td>—</td> <td>—</td>	2.0	—	—	—	—	—
	M9325	—	■	375	0.13 <td>2.0</td> <td>▣</td> <td>—</td> <td>—</td> <td>—</td> <td>■</td> <td>355</td> <td>0.13 <td>2.0</td> <td>—</td> <td>—</td> <td>—</td> <td>—</td> <td>—</td> </td>	2.0	▣	—	—	—	■	355	0.13 <td>2.0</td> <td>—</td> <td>—</td> <td>—</td> <td>—</td> <td>—</td>	2.0	—	—	—	—	—
	M9340	—	■	345	0.13 <td>2.0</td> <td>▣</td> <td>205</td> <td>0.13 <td>2.0</td> <td>■</td> <td>—</td> <td>—</td> <td>—</td> <td>—</td> <td>—</td> <td>—</td> <td>—</td> <td>—</td> </td>	2.0	▣	205	0.13 <td>2.0</td> <td>■</td> <td>—</td> <td>—</td> <td>—</td> <td>—</td> <td>—</td> <td>—</td> <td>—</td> <td>—</td>	2.0	■	—	—	—	—	—	—	—	—



Suitability and starting values for cutting speed (vc), feed (f) and depth of cut (ap). Refer to our Machining Calculator app for further calculations.

Product	RE [mm]	P			M			K			N			S			H		
		vc [m/min]	f [mm/tooth]	ap [mm]	vc [m/min]	f [mm/tooth]	ap [mm]	vc [m/min]	f [mm/tooth]	ap [mm]	vc [m/min]	f [mm/tooth]	ap [mm]	vc [m/min]	f [mm/tooth]	ap [mm]	vc [m/min]	f [mm/tooth]	ap [mm]

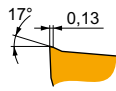

R geometry with highly positive design for medium to heavy machining.

HNGX 0604ANSN-R	8215	—	■	280	0.18	1.8	☑	165	0.18	1.8	■	265	0.18	1.8	—	—	—	☑	55	0.15	1.0
	M5315	—	☑	370	0.18	1.8	—	—	—	—	■	350	0.18	1.8	—	—	—	☑	70	0.15	1.0
	M8310	—	■	300	0.18	1.8	☑	150	0.18	1.8	■	285	0.18	1.8	—	—	—	☑	60	0.15	1.0
	M8330	—	■	275	0.18	1.8	☑	165	0.18	1.8	■	260	0.18	1.8	—	—	—	☑	55	0.15	1.0
	M8340	—	■	250	0.18	1.8	☑	150	0.18	1.8	■	235	0.18	1.8	—	—	—	—	—	—	—
	M9325	—	■	345	0.18	1.8	—	—	—	—	■	325	0.18	1.8	—	—	—	☑	65	0.15	1.0

XNGX 06



	IC [mm]	D1 [mm]	S [mm]
0604	10.500	3.70	4.76

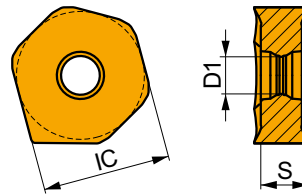

Suitability and starting values for cutting speed (vc), feed (f) and depth of cut (ap). Refer to our Machining Calculator app for further calculations.

Product	RE [mm]	P			M			K			N			S			H		
		vc [m/min]	f [mm/tooth]	ap [mm]	vc [m/min]	f [mm/tooth]	ap [mm]	vc [m/min]	f [mm/tooth]	ap [mm]	vc [m/min]	f [mm/tooth]	ap [mm]	vc [m/min]	f [mm/tooth]	ap [mm]	vc [m/min]	f [mm/tooth]	ap [mm]

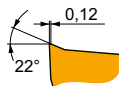

Wiper design for improved surface finish.

XNGX 0604ANSN	8215	—	■	290	0.13	1.8	☑	170	0.12	1.8	■	275	0.13	1.8	—	—	—	—	—	—	—
----------------------	-------------	---	---	-----	------	-----	---	-----	------	-----	---	-----	------	-----	---	---	---	---	---	---	---



a_s / DC	5%	10%	15%	20%	25%	30%	40%	50%	60%	70%	75%	80%	90%	100%
	1.48	1.35	1.27	1.22	1.19	1.16	1.11	1.08	1.05	1.03	1.00	1.00	1.00	1.00
	2.20	1.60	1.35	1.20	1.10	0.95	0.85	0.75	0.85	0.95	1.00	1.00	1.00	1.00
	0.64	0.64	0.64	0.64	0.64	0.65	0.65	0.67	0.68	0.71	0.72	0.74	0.79	1.00

	HNGX 06-F	HNGX 06-M	HNGX 06-R	XNGX 06
	-	-	-	-
	1.12	0.80	0.80	4.15

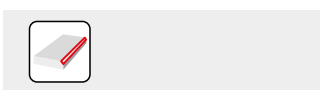
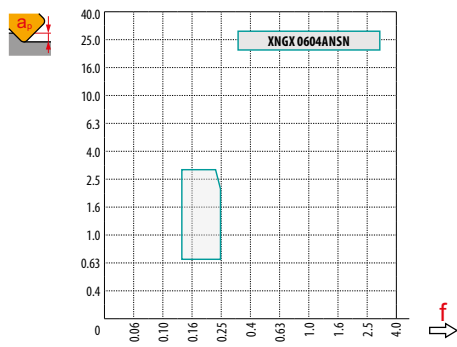
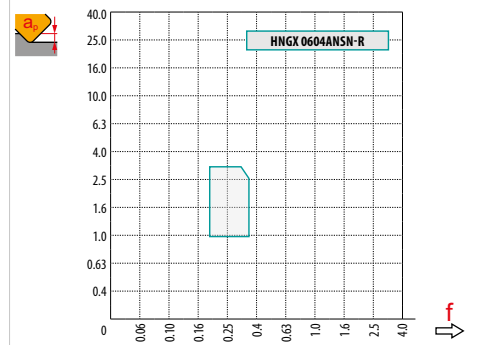
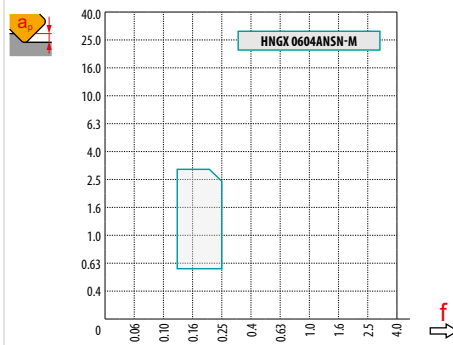
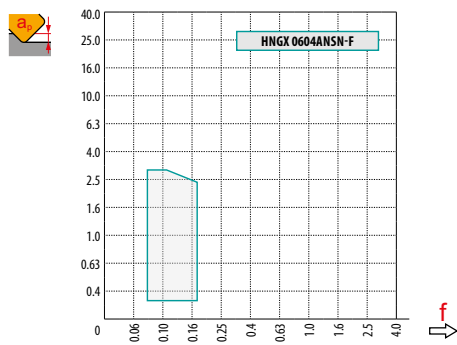

DC	X.V	f_{max}
25	1.31	0.24
32	1.36	0.28
40	1.40	0.31
50	1.45	0.35
63	1.49	0.39
80	1.54	0.44
100	1.59	0.49
125	1.64	0.55

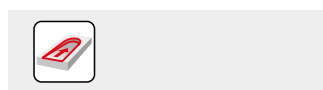

DC	RPMX	APMX/I
25	2.7	3.0/65
32	1.9	3.0/89
40	1.5	2.5/100
50	1.1	1.9/100
63	0.9	1.4/100
80	0.6	1.0/100
100	0.5	0.8/100
125	0.4	0.6/100

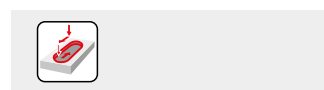

0.9



SHN09C



PRAMET

S



ECON HN09 45° Face Mill with Double Negative Design and Internal Coolant

Highly productive 45° face mill utilising double sided HN..09 style inserts with APMX of 5 mm. Roughing, finishing and chamfering. Economical insert with 12 cutting edges. Differential tooth pitch. Arbor style only in range from Ø50 up to Ø315 mm. Body treated for longer tool life.

KAPR	45°
APMX	5.0 mm

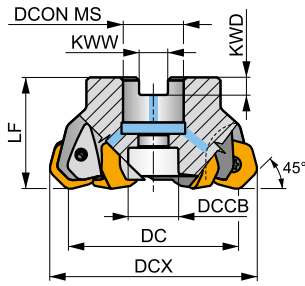
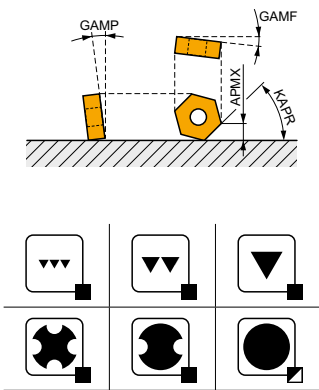

DC 50 - 125 mm

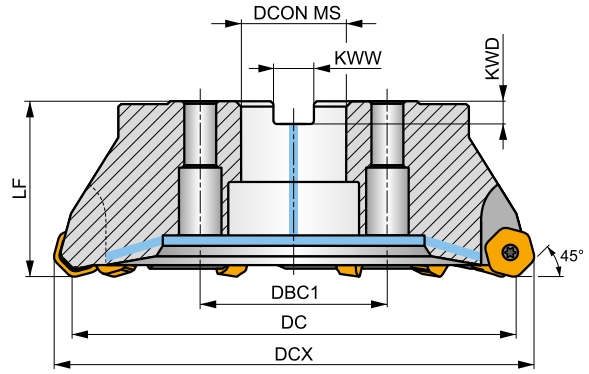

DC 160 - 315 mm

h_m 0.08 - 0.25



Product	DC	DCX	LF	DCON MS	DCCB	DBC1	KWW	KWD	GAMF	GAMP					kg			
	[mm]	[mm]	[mm]	[mm]	[mm]	[mm]	[mm]	[mm]	[°]	[°]								
50A04R-S45HN09C-CF	50	61.7	40	22	18	-	10.4	6.3	-7	-7	4	✓	7900	✓	0.38	G1252	FA023	-
63A06R-S45HN09C-CF	63	74.7	40	22	18	-	10.4	6.3	-7	-7	6	✓	7000	✓	0.54	G1252	FA023	-
80A06R-S45HN09C-CF	80	91.7	50	27	38	-	12.4	7	-7	-7	6	✓	6200	✓	1.06	G1252	FA021	AC001
80A08R-S45HN09C-CF	80	91.7	50	27	38	-	12.4	7	-7	-7	8	✓	6200	✓	1.06	G1252	FA021	AC001
100A06R-S45HN09C-CF	100	111.7	50	32	45	-	14.4	8	-7	-7	6	✓	5600	✓	1.76	G1252	FA021	AC002
100A08R-S45HN09C-CF	100	111.7	50	32	45	-	14.4	8	-7	-7	8	✓	5600	✓	1.76	G1252	FA021	AC002
100A10R-S45HN09C-CF	100	111.7	50	32	45	-	14.4	8	-8	-7	10	-	5600	✓	1.76	G1252	FA021	AC002
125A06R-S45HN09C-CF	125	136.7	63	40	56	-	16.4	9	-7	-7	6	✓	5000	✓	3.36	G1252	FA021	AC003
125A08R-S45HN09C-CF	125	136.7	63	40	56	-	16.4	9	-7	-7	8	✓	4900	✓	3.72	G1252	FA021	AC003
125A10R-S45HN09C-CF	125	136.7	63	40	56	-	16.4	9	-7	-7	10	✓	5000	✓	3.36	G1252	FA021	AC003
125A12R-S45HN09C-CF	125	136.7	63	40	56	-	16.4	9	-8	-7	12	-	5000	✓	3.36	G1252	FA021	AC003
160C08R-S45HN09C-CF	160	171.7	63	40	-	66.7	16.4	9	-7	-7	8	✓	4400	✓	6.30	G1252	FA026	-
160C12R-S45HN09C-CF	160	171.7	63	40	-	66.7	16.4	9	-7	-7	12	✓	4400	✓	6.46	G1252	FA026	-
160C14R-S45HN09C-CF	160	171.7	63	40	-	66.7	16.4	9	-7	-7	14	✓	4400	✓	6.45	G1252	FA026	-
200C10R-S45HN09C-CF	200	211.7	63	60	-	101.6	25.7	14	-7	-7	10	✓	3900	✓	11.37	G1252	FA027	-
250C14R-S45HN09C-CF	250	261.7	63	60	-	101.6	25.7	14	-7	-7	14	✓	3500	✓	18.50	G1252	FA028	-
315C16R-S45HN09C-CF	315	326.7	80	60	-	101.6	25.7	14	-7	-7	16	✓	3100	✓	37.00	G1252	FA029	-



G1252

HNGX 0906AN..

XNGX 0906AN..



FA021	US 54511-T15P	5.0	M 4.5	11	D-T08P/T15P	FG-15	-	-	-	-	-	-
FA023	US 54511-T15P	5.0	M 4.5	11	D-T08P/T15P	FG-15	HS 1030C	-	-	-	-	-
FA026	US 54511-T15P	5.0	M 4.5	11	D-T08P/T15P	FG-15	HS 1240C	CAC 160C	HSD 0825C	HXK 5	-	-
FA027	US 54511-T15P	5.0	M 4.5	11	D-T08P/T15P	FG-15	HS 1655C	CAC 200C	HSD 1025C	HXK 7	-	-
FA028	US 54511-T15P	5.0	M 4.5	11	D-T08P/T15P	FG-15	HS 1655C	CAC 250C	HSD 1025C	HXK 7	-	-
FA029	US 54511-T15P	5.0	M 4.5	11	D-T08P/T15P	FG-15	HS 1655C	CAC 315C	HSD 1035C	HXK 7	CACP 3150C	RRH 34

AC001		KS 1230	K.FMH27
AC002		KS 1635	K.FMH32
AC003		KS 2040	K.FMH40

HNGX 09



	IC	D1	S
	[mm]	[mm]	[mm]
0906	16.500	4.90	6.35

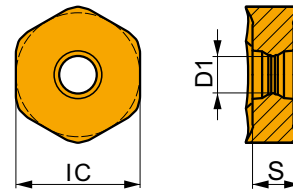

Suitability and starting values for cutting speed (vc), feed (f) and depth of cut (ap). Refer to our Machining Calculator app for further calculations.

Product	RE	P			M			K			N			S			H			
		vc	f	ap	vc	f	ap	vc	f	ap	vc	f	ap	vc	f	ap	vc	f	ap	
	[mm]	[m/min]	[mm/tooth]	[mm]	[m/min]	[mm/tooth]	[mm]	[m/min]	[mm/tooth]	[mm]	[m/min]	[mm/tooth]	[mm]	[m/min]	[mm/tooth]	[mm]	[m/min]	[mm/tooth]	[mm]	
 FF geometry with highly positive design for light machining.	22°																			
	8215	-	345	0.10	1.0	205	0.09	1.0	-	-	-	-	-	-	-	-	-	-	-	-
	M8330	-	335	0.10	1.0	200	0.09	1.0	-	-	-	-	-	-	-	-	-	-	-	-
		M9340	-	405	0.10	1.0	240	0.09	1.0	-	-	-	-	-	-	-	-	-	-	-
 F geometry with highly positive design for light to medium machining.	22°																			
	0.07	8215	-	300	0.12	2.1	180	0.11	2.1	-	-	-	-	-	-	-	-	-	-	-
		M6330	-	255	0.12	2.1	180	0.11	2.1	-	-	-	-	-	-	-	-	-	-	-
		M8310	-	330	0.12	2.1	165	0.11	2.1	-	-	-	-	-	-	-	-	-	-	-
		M8330	-	300	0.12	2.1	180	0.11	2.1	-	-	-	-	-	-	-	-	-	-	-
	M8340	-	270	0.12	2.1	160	0.11	2.1	-	-	-	-	-	-	-	-	-	-	-	



Suitability and starting values for cutting speed (vc), feed (f) and depth of cut (ap). Refer to our Machining Calculator app for further calculations.

Product	RE [mm]	P			M			K			N			S			H		
		vc [m/min]	f [mm/tooth]	ap [mm]	vc [m/min]	f [mm/tooth]	ap [mm]	vc [m/min]	f [mm/tooth]	ap [mm]	vc [m/min]	f [mm/tooth]	ap [mm]	vc [m/min]	f [mm/tooth]	ap [mm]	vc [m/min]	f [mm/tooth]	ap [mm]

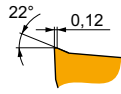

M geometry with highly positive design for medium machining.

HNGX 0906ANSN-M	8215	—	■	255	0.20	2.7	☑	150	0.18	2.7	■	240	0.20	2.7	—	—	—	—	—	—
	M5315	—	☑	340	0.20	2.7	—	—	—	—	■	320	0.20	2.7	—	—	—	—	—	—
	M6330	—	■	205	0.20	2.7	—	—	—	—	—	—	—	—	—	—	—	—	—	—
	M8310	—	■	280	0.20	2.7	☑	140	0.18	2.7	■	265	0.20	2.7	—	—	—	—	—	—
	M8330	—	■	255	0.20	2.7	☑	150	0.18	2.7	■	240	0.20	2.7	—	—	—	—	—	—
	M8340	—	■	235	0.20	2.7	☑	140	0.18	2.7	☑	220	0.20	2.7	—	—	—	—	—	—
	M9315	—	■	340	0.20	2.7	—	—	—	—	■	320	0.20	2.7	—	—	—	—	—	—
	M9325	—	■	315	0.20	2.7	—	—	—	—	■	295	0.20	2.7	—	—	—	—	—	—
	M9340	—	■	290	0.20	2.7	☑	170	0.18	2.7	—	—	—	—	—	—	—	—	—	—

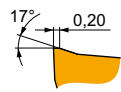

R geometry with positive design for medium to heavy machining.

HNGX 0906ANSN-R	8215	—	■	240	0.25	3.0	☑	140	0.25	3.0	■	225	0.25	3.0	—	—	—	—	☑	45	0.15	1.0
	M5315	—	☑	305	0.25	3.0	—	—	—	—	■	285	0.25	3.0	—	—	—	—	☑	60	0.15	1.0
	M8310	—	■	260	0.25	3.0	☑	130	0.25	3.0	■	245	0.25	3.0	—	—	—	—	☑	50	0.15	1.0
	M8330	—	■	240	0.25	3.0	☑	140	0.25	3.0	■	225	0.25	3.0	—	—	—	—	☑	45	0.15	1.0
	M8340	—	■	220	0.25	3.0	☑	130	0.25	3.0	☑	205	0.25	3.0	—	—	—	—	—	—	—	—
	M9315	—	■	310	0.25	3.0	—	—	—	—	■	290	0.25	3.0	—	—	—	—	☑	60	0.15	1.0
	M9325	—	■	295	0.25	3.0	—	—	—	—	■	280	0.25	3.0	—	—	—	—	☑	55	0.15	1.0

XNGX 09

PRAMET

	IC [mm]	D1 [mm]	S [mm]
0906	16.500	4.90	6.35

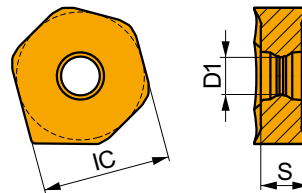

Suitability and starting values for cutting speed (vc), feed (f) and depth of cut (ap). Refer to our Machining Calculator app for further calculations.

Product	RE [mm]	P			M			K			N			S			H		
		vc [m/min]	f [mm/tooth]	ap [mm]	vc [m/min]	f [mm/tooth]	ap [mm]	vc [m/min]	f [mm/tooth]	ap [mm]	vc [m/min]	f [mm/tooth]	ap [mm]	vc [m/min]	f [mm/tooth]	ap [mm]	vc [m/min]	f [mm/tooth]	ap [mm]

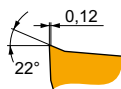

Wiper design for improved surface finish.

XNGX 0906ANSN	8215	—	■	245	0.20	2.7	☑	145	0.18	2.7	■	230	0.20	2.7	—	—	—	—	—	—
	M8330	—	■	245	0.20	2.7	☑	145	0.18	2.7	■	230	0.20	2.7	—	—	—	—	—	—



a_s DC	5%	10%	15%	20%	25%	30%	40%	50%	60%	70%	75%	80%	90%	100%
	1.48	1.35	1.27	1.22	1.19	1.16	1.11	1.08	1.05	1.03	1.00	1.00	1.00	1.00
	2.20	1.60	1.35	1.20	1.10	0.95	0.85	0.75	0.85	0.95	1.00	1.00	1.00	1.00
	0.64	0.64	0.64	0.64	0.64	0.65	0.65	0.67	0.68	0.71	0.72	0.74	0.79	1.00

	HNGX 09-FF	HNGX 09-F	HNGX 09-M	HNGX 09-R	XNGX 09
	-	-	-	-	-
	1.50	1.17	1.17	1.17	7.53

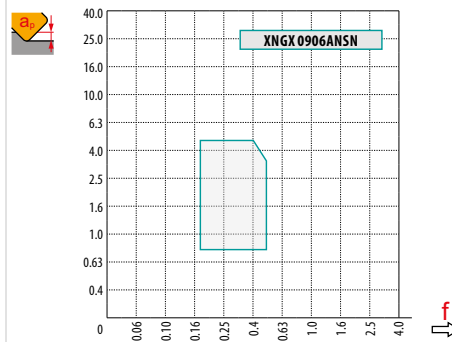
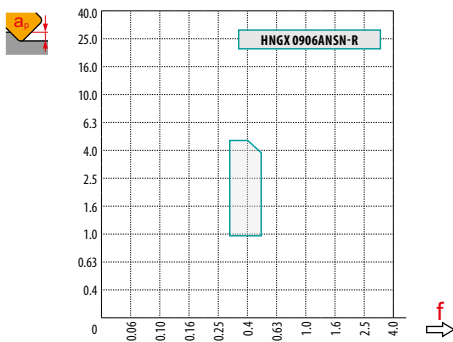
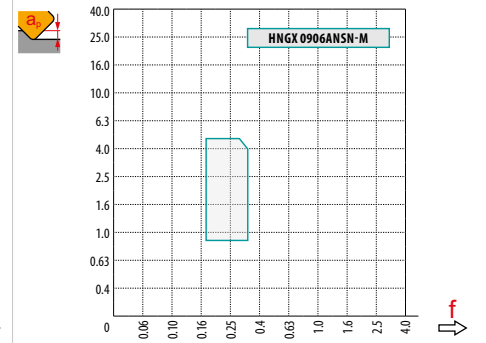
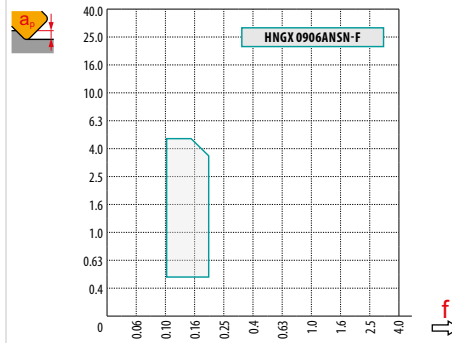
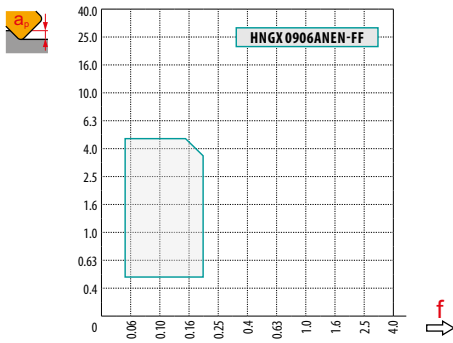

DC	X.V	f_{max}
50	1.35	0.36
63	1.39	0.40
80	1.44	0.45
100	1.48	0.51
125	1.53	0.57
160	1.58	0.64
200	1.63	0.72
250	1.68	0.80
315	1.74	0.90

DC	RPMX	APMX/I
50	2.1	3.5/100
63	1.5	2.5/100
80	1.1	1.8/100
100	0.9	1.4/100
125	0.7	1.1/100
160	0.5	0.7/100

1.9



SOD05



PRAMET

S



Universal Face Mill with Positive Design and Internal Coolant

Highly productive universal face mill utilising single-sided positive inserts with APMX up to 10 mm. Unique insert seat fits OD.. 05, RD.. 12 and SD.. 12 style inserts, suited for wide range of applications. Differential tooth pitch. Arbor and cylindrical style in range from Ø32 up to Ø125 mm. Body treated for longer tool life.

KAPR	45°
APMX	2.7 (10.0) mm

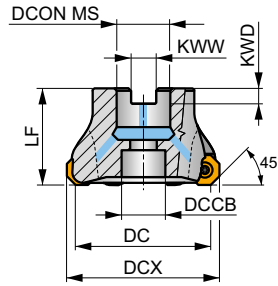
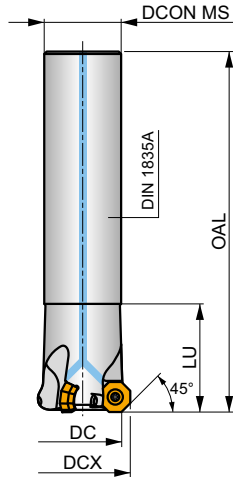
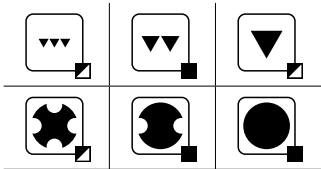
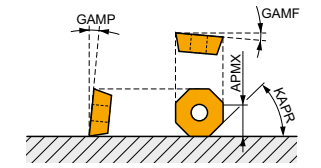

	0.03 - 0.15
	0.03 - 0.12



Product	DCX	DC	OAL	DCON MS	DCCB	LU	LF	KAPR	KWW	KWD	GAMF	GAMP	max.		kg	Icons				
	[mm]	[mm]	[mm]	[mm]	[mm]	[mm]	[mm]	[°]	[mm]	[mm]	[°]	[°]								
32N3R045A25-SOD05-C	32	24.7	130	25	-	45	-	45	-	-	-10	8	3	-	17700	✓	0.41	GI326	FA049	-
40N3R045A32-SOD05-C	40	32.6	150	32	-	45	-	45	-	-	-7	8	3	-	15800	✓	0.86	GI326	FA040	-
40A03R-S45OD05-C	40	32.7	-	16	14	-	40	45	8.4	5.6	-10	8	3	-	15800	✓	0.19	GI326	FA042	-
50A04R-S45OD05-C	50	42.6	-	22	18	-	40	45	10.4	6.3	-7	8	4	-	14100	✓	0.28	GI326	FA043	-
50A05R-S45OD05-C	50	42.6	-	22	18	-	40	45	10.4	6.3	-7	8	5	-	14100	✓	0.28	GI326	FA043	-
63A05R-S45OD05-C	63	55.6	-	22	18	-	40	45	10.4	6.3	-7	8	5	✓	12600	✓	0.39	GI326	FA043	-
63A06R-S45OD05-C	63	55.6	-	22	18	-	40	45	10.4	6.3	-7	8	6	✓	12600	✓	0.40	GI326	FA043	-
80A06R-S45OD05-C	80	72.6	-	27	38	-	50	45	12.4	7	-7	8	6	✓	11100	✓	0.73	GI326	FA041	AC001
80A08R-S45OD05-C	80	72.6	-	27	38	-	50	45	12.4	7	-7	8	8	✓	11100	✓	0.66	GI326	FA041	AC001
100A07R-S45OD05-C	100	92.6	-	32	45	-	50	45	14.4	8	-7	8	7	✓	10000	✓	1.09	GI326	FA041	AC002
125A08R-S45OD05-C	125	117.6	-	40	56	-	63	45	16.4	9	-7	8	8	✓	8900	✓	2.20	GI326	FA041	AC003

GI326	OD.. 0505..	RD.. 1205..	SDKT 1205..	SDMT 1205..SN

FA040	US 45014-T20P	5.0	M 5	13	Flag T20P	-	-
FA041	US 45014-T20P	5.0	M 5	13	-	SDR T20P-T	-
FA042	US 45014-T20P	5.0	M 5	13	-	SDR T20P-T	HS 90835
FA043	US 45014-T20P	5.0	M 5	13	-	SDR T20P-T	HS 1030C
FA049	US 45011-T20P	5.0	M 5	11	Flag T20P	-	-



AC001	KS 1230	K.FMH27
AC002	KS 1635	K.FMH32
AC003	KS 2040	K.FMH40

ODKT 05IM



	IC	D1	S	BS
	[mm]	[mm]	[mm]	[mm]
0505	12.700	5.50	5.56	1.00

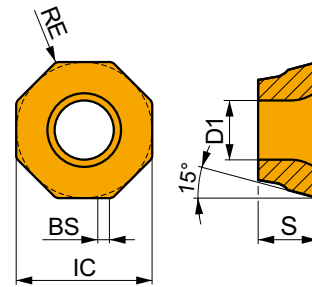

Suitability and starting values for cutting speed (vc), feed (f) and depth of cut (ap). Refer to our Machining Calculator app for further calculations.

Product	RE [mm]	P			M			K			N			S			H		
		vc [m/min]	f [mm/tooth]	ap [mm]	vc [m/min]	f [mm/tooth]	ap [mm]	vc [m/min]	f [mm/tooth]	ap [mm]	vc [m/min]	f [mm/tooth]	ap [mm]	vc [m/min]	f [mm/tooth]	ap [mm]			

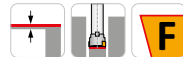
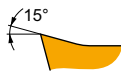

F geometry, 45° face milling insert, with highly positive design for light machining.

ODKT 0505ADFR-F	M8310	0.8	■ 275	0.15	2.5	■ 140	0.14	2.5	■ -	-	-	■ -	-	-	■ -	-	-
------------------------	--------------	-----	-------	------	-----	-------	------	-----	-----	---	---	-----	---	---	-----	---	---

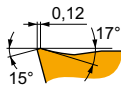

FM geometry, 45° face milling insert, with positive design for light to medium machining.

ODKT 0505ADSR-FM	M6330	0.8	■ 190	0.25	2.5	■ 135	0.23	2.5	■ -	-	-	■ -	-	-	■ -	-	-
	M8310	0.8	■ 240	0.25	2.5	■ 120	0.23	2.5	■ 225	0.25	2.5	■ -	-	-	■ -	-	-
	M8330	0.8	■ 225	0.25	2.5	■ 135	0.23	2.5	■ 210	0.25	2.5	■ -	-	-	■ -	-	-
	M8345	0.8	■ 160	0.25	2.5	■ 95	0.23	2.5	■ -	-	-	■ -	-	-	■ -	-	-
	M9340	0.8	■ 245	0.25	2.5	■ 145	0.23	2.5	■ -	-	-	■ -	-	-	■ -	-	-



ODMT 051M

PRAMET

	IC	D1	S
	[mm]	[mm]	[mm]
0505	12.700	5.50	5.56

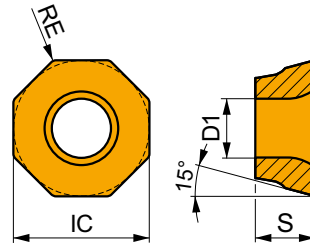

Suitability and starting values for cutting speed (vc), feed (f) and depth of cut (ap). Refer to our Machining Calculator app for further calculations.

Product	RE	P			M			K			N			S			H		
		vc	f	ap	vc	f	ap	vc	f	ap	vc	f	ap	vc	f	ap	vc	f	ap
	[mm]	[m/min]	[mm/tooth]	[mm]	[m/min]	[mm/tooth]	[mm]	[m/min]	[mm/tooth]	[mm]	[m/min]	[mm/tooth]	[mm]	[m/min]	[mm/tooth]	[mm]	[m/min]	[mm/tooth]	[mm]

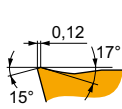

FM geometry, 45° face milling insert, with positive design for light to medium machining.

ODMT 0505ADSR-FM	M8340	0.8	200	0.25	2.5	120	0.23	2.5	190	0.25	2.5	-	-	-	-	-	-	-	-
	M9340	0.8	245	0.25	2.5	145	0.23	2.5	-	-	-	-	-	-	-	-	-	-	-

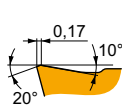

R geometry, 45° face milling insert, with positive design for unstable cutting conditions.

ODMT 050508SN-R	M8330	0.8	190	0.25	2.5	-	-	-	180	0.25	2.5	-	-	-	-	-	-	-	-
	M9340	0.8	210	0.25	2.5	-	-	-	-	-	-	-	-	-	-	-	-	-	-

RDGT 121M

PRAMET

	INSD	D1	S
	[mm]	[mm]	[mm]
1205	12.7	5.50	5.56

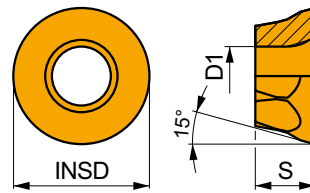

Suitability and starting values for cutting speed (vc), feed (f) and depth of cut (ap). Refer to our Machining Calculator app for further calculations.

Product	RE	P			M			K			N			S			H		
		vc	f	ap	vc	f	ap	vc	f	ap	vc	f	ap	vc	f	ap	vc	f	ap
	[mm]	[m/min]	[mm/tooth]	[mm]	[m/min]	[mm/tooth]	[mm]	[m/min]	[mm/tooth]	[mm]	[m/min]	[mm/tooth]	[mm]	[m/min]	[mm/tooth]	[mm]	[m/min]	[mm/tooth]	[mm]

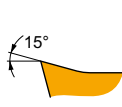

F geometry with highly positive design for light machining.

RDGT 120500FN-F	M8310	-	210	0.20	1.5	105	0.18	1.5	-	-	-	-	-	-	-	-	-	-	-
------------------------	--------------	---	-----	------	-----	-----	------	-----	---	---	---	---	---	---	---	---	---	---	---



Suitability and starting values for cutting speed (vc), feed (f) and depth of cut (ap). Refer to our Machining Calculator app for further calculations.

Product	RE [mm]	P			M			K			N			S			H		
		vc [m/min]	f [mm/tooth]	ap [mm]	vc [m/min]	f [mm/tooth]	ap [mm]	vc [m/min]	f [mm/tooth]	ap [mm]	vc [m/min]	f [mm/tooth]	ap [mm]	vc [m/min]	f [mm/tooth]	ap [mm]	vc [m/min]	f [mm/tooth]	ap [mm]

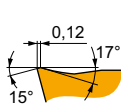

FM geometry with positive design for light to medium machining.

RDGT 120500SN-FM	M8330	-	■	190	0.20	1.5	▣	110	0.18	1.5	▣	180	0.20	1.5	-	-	-	-	-	-
	M8345	-	■	140	0.20	1.5	▣	80	0.18	1.5	▣	-	-	-	-	-	-	-	-	-

RDMT 12IM



	INSD [mm]	D1 [mm]	S [mm]
1205	12.7	5.50	5.56

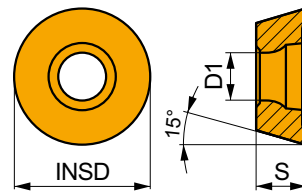

Suitability and starting values for cutting speed (vc), feed (f) and depth of cut (ap). Refer to our Machining Calculator app for further calculations.

Product	RE [mm]	P			M			K			N			S			H		
		vc [m/min]	f [mm/tooth]	ap [mm]	vc [m/min]	f [mm/tooth]	ap [mm]	vc [m/min]	f [mm/tooth]	ap [mm]	vc [m/min]	f [mm/tooth]	ap [mm]	vc [m/min]	f [mm/tooth]	ap [mm]	vc [m/min]	f [mm/tooth]	ap [mm]

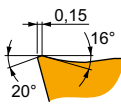

R geometry, copy and profile milling insert, with positive design for unstable cutting conditions.

RDMT 120500SN-R	M8330	-	■	175	0.30	1.5	-	-	-	▣	165	0.30	1.5	-	-	-	-	-	-
	M8340	-	■	160	0.30	1.5	-	-	-	▣	150	0.30	1.5	-	-	-	-	-	-
	M9340	-	■	190	0.30	1.5	-	-	-	▣	-	-	-	-	-	-	-	-	-



SDKT 12IM

PRAMET

	IC	D1	S
	[mm]	[mm]	[mm]
1205	12.700	5.50	5.56

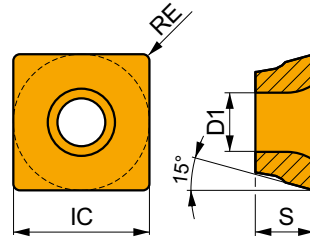

Suitability and starting values for cutting speed (vc), feed (f) and depth of cut (ap). Refer to our Machining Calculator app for further calculations.

Product	RE	P			M			K			N			S			H		
		vc	f	ap	vc	f	ap	vc	f	ap	vc	f	ap	vc	f	ap	vc	f	ap
	[mm]	[m/min]	[mm/tooth]	[mm]	[m/min]	[mm/tooth]	[mm]	[m/min]	[mm/tooth]	[mm]	[m/min]	[mm/tooth]	[mm]	[m/min]	[mm/tooth]	[mm]	[m/min]	[mm/tooth]	[mm]

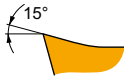

F geometry, 90° shoulder milling insert, with highly positive design for light machining.

SDKT 1205PDFR-F	8215	0.8	■ 285	0.10	4.0	☑ 170	0.09	4.0	—	—	—	☑ 855	0.12	4.0	—	—	—	—	—	—
-----------------	------	-----	-------	------	-----	-------	------	-----	---	---	---	-------	------	-----	---	---	---	---	---	---

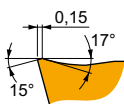
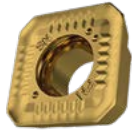

FM geometry, 90° shoulder milling insert, with positive design for light to medium machining.

SDKT 1205AESN-FM	M6330	—	■ 240	0.15	4.0	☑ 170	0.15	4.0	—	—	—	—	—	—	—	—	—	—	—	—
	M8330	—	■ 280	0.15	4.0	☑ 165	0.15	4.0	☑ 265	0.15	4.0	—	—	—	—	—	—	—	—	—
	M8345	—	■ 205	0.15	4.0	☑ 120	0.15	4.0	—	—	—	—	—	—	—	—	—	—	—	—
SDKT 1205PDSR-FM	M8330	0.8	■ 255	0.15	4.0	☑ 150	0.15	4.0	☑ 240	0.15	4.0	—	—	—	—	—	—	—	—	—
	M8345	0.8	■ 185	0.15	4.0	☑ 110	0.15	4.0	—	—	—	—	—	—	—	—	—	—	—	—

SDMT 12IM

PRAMET

	IC	D1	S
	[mm]	[mm]	[mm]
1205	12.700	5.50	5.56

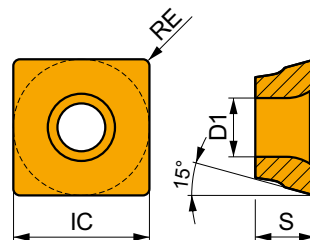

Suitability and starting values for cutting speed (vc), feed (f) and depth of cut (ap). Refer to our Machining Calculator app for further calculations.

Product	RE	P			M			K			N			S			H		
		vc	f	ap	vc	f	ap	vc	f	ap	vc	f	ap	vc	f	ap	vc	f	ap
	[mm]	[m/min]	[mm/tooth]	[mm]	[m/min]	[mm/tooth]	[mm]	[m/min]	[mm/tooth]	[mm]	[m/min]	[mm/tooth]	[mm]	[m/min]	[mm/tooth]	[mm]	[m/min]	[mm/tooth]	[mm]

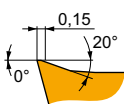

F geometry, 90° shoulder milling insert, with positive design for light to medium machining.

SDMT 120508SN-F	M8310	0.8	■ 265	0.15	4.0	☑ 135	0.15	4.0	—	—	—	—	—	—	—	—	—	—	—	—
	M8330	0.8	■ 245	0.15	4.0	☑ 145	0.15	4.0	—	—	—	☑ 735	0.18	4.0	—	—	—	—	—	—



Suitability and starting values for cutting speed (vc), feed (f) and depth of cut (ap). Refer to our Machining Calculator app for further calculations.

Product	RE [mm]	P			M			K			N			S			H		
		vc [m/min]	f [mm/tooth]	ap [mm]	vc [m/min]	f [mm/tooth]	ap [mm]	vc [m/min]	f [mm/tooth]	ap [mm]	vc [m/min]	f [mm/tooth]	ap [mm]	vc [m/min]	f [mm/tooth]	ap [mm]	vc [m/min]	f [mm/tooth]	ap [mm]

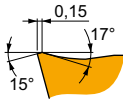

FM geometry, 90° shoulder milling insert, with positive design for medium machining.

SDMT 120508SN-FM	M8345	0.8	■	175	0.15	4.0	■	105	0.15	4.0	■	-	-	-	-	-	-	-	-
-------------------------	--------------	-----	---	-----	------	-----	---	-----	------	-----	---	---	---	---	---	---	---	---	---

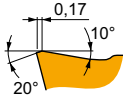

R geometry, 90° shoulder milling insert, with positive design for unstable cutting conditions.

SDMT 120508SN-R	M8330	0.8	■	225	0.20	4.0	■	-	-	-	■	210	0.20	4.0	■	-	-	-	-
	M8345	0.8	■	165	0.20	4.0	■	-	-	-	■	-	-	-	■	-	-	-	-
	M9340	0.8	■	250	0.20	4.0	■	-	-	-	■	-	-	-	■	-	-	-	-
SDMT 1205AESN-R	M8330	-	■	265	0.20	4.0	■	-	-	-	■	250	0.20	4.0	■	-	-	-	-
	M8340	-	■	240	0.20	4.0	■	-	-	-	■	225	0.20	4.0	■	-	-	-	-



a_e DCX	5 %	10 %	15 %	20 %	25 %	30 %	40 %	50 %	60 %	70 %	75 %	80 %	90 %	100 %
	1.48	1.35	1.27	1.22	1.19	1.16	1.11	1.08	1.05	1.03	1.00	1.00	1.00	1.00
	2.20	1.60	1.35	1.20	1.10	0.95	0.85	0.75	0.85	0.95	1.00	1.00	1.00	1.00
	0.64	0.64	0.64	0.64	0.64	0.65	0.65	0.67	0.68	0.71	0.72	0.74	0.79	1.00

	ODKT 05-F	ODKT 05-FM	ODMT 05-FM	ODMT 05-R
	0.4	0.8	0.8	0.8
	1.00	1.00	–	–

	RDGT 12-F	RDGT 12-FM	RDGT 12-R
	6.35	6.35	6.35
	–	–	–

	SDKT 12-F	SDKT 12-FM	SDMT 12-F	SDMT 12-R
	0.8	0.8	0.8	0.8
	2.30	2.30	–	–

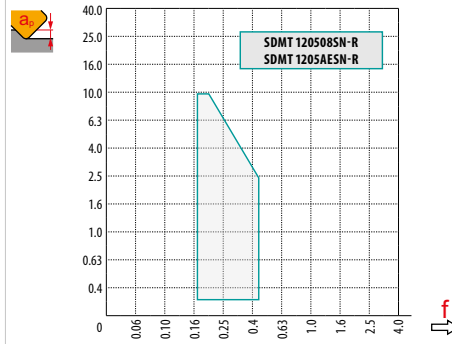
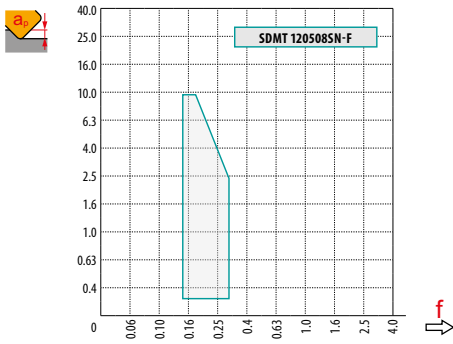
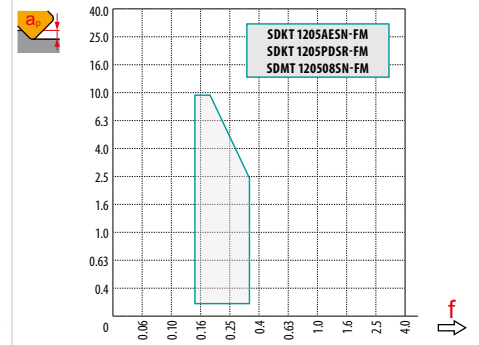
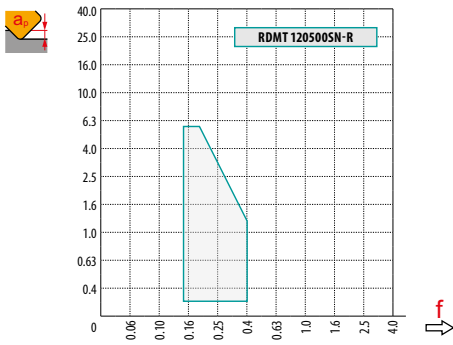
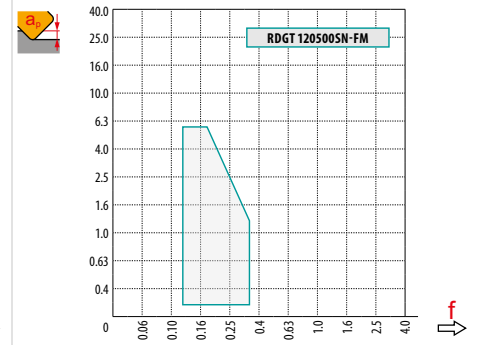
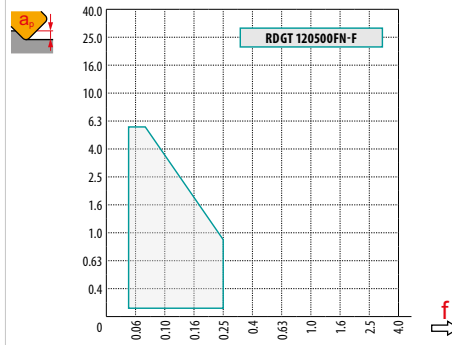
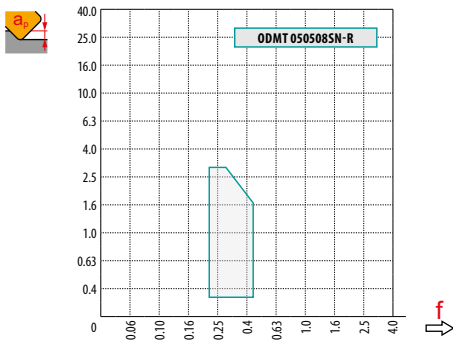
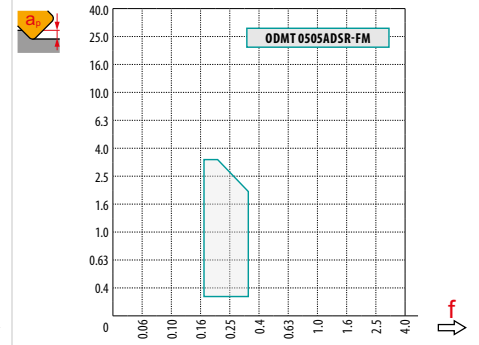
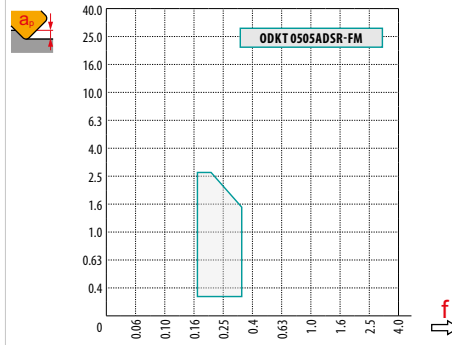
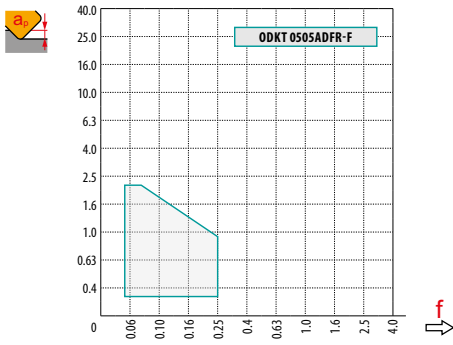

		R												
		0.25	0.50	0.60	0.70	0.80	1.00	1.25	1.50	2.00	3.00	4.00	5.00	6.00
32		23.43	24.80	25.23	25.62	25.99	26.63	27.33	27.94	28.94	30.39	31.31	31.83	32.00
40		31.43	32.80	33.23	33.62	33.99	34.63	35.33	35.94	36.94	38.39	39.31	39.83	40.00
50		41.43	42.80	43.23	43.62	43.99	44.63	45.33	45.94	46.94	48.39	49.31	49.83	50.00
63		54.43	55.80	56.23	56.62	56.99	57.63	58.33	58.94	59.94	61.39	62.31	62.83	63.00
80		71.43	72.80	73.23	73.62	73.99	74.63	75.33	75.94	76.94	78.39	79.31	79.83	80.00
100		91.43	92.80	93.23	93.62	93.99	94.63	95.33	95.94	96.94	98.39	99.31	99.83	100.00
125		116.43	117.80	118.23	118.62	118.99	119.63	120.33	120.94	121.94	123.39	124.31	124.83	125.00



		f_{max}
32	1.36	0.28
40	1.40	0.31
50	1.43	0.33
63	1.47	0.37
80	1.52	0.42
100	1.57	0.47
125	1.62	0.52



S



10.0



S

	1.0	5.0	10.0
	0.35	0.21	0.15



O

	RPMX	APMX/I
50	4.1	7.05/100
63	2.7	4.6/100
80	1.8	3/100
100	1.7	2.85/100
125	0.7	1.1/100



R

	RPMX	APMX/I
50	3.8	6.2/95
63	2.5	4.25/100
80	1.7	2.85/100
100	1.6	2.65/100
125	0.3	0.4/100



O

	DMIN	DMAX		
50	78.0	100.0	4.5	4.5
63	105.0	126.0	4.5	4.5
80	138.0	160.0	4.5	4.5
100	178.0	200.0	4.5	4.5
125	229.0	250.0	4.0	4.5



R

	DMIN	DMAX		
50	78.0	100.0	4.5	4.5
63	105.0	126.0	4.5	4.5
80	138.0	160.0	4.5	4.5
100	178.0	200.0	4.5	4.5
125	230.0	250.0	4.0	4.5



O **R**



2.4 2.3



R

	μm	3	5	10	15	20	30	40	50	60	80	100
32		0.620	0.800	1.131	1.386	1.600	1.960	2.263	2.530	2.771	3.200	3.578
40		0.693	0.894	1.265	1.549	1.789	2.191	2.530	2.828	3.098	3.578	4.000
50		0.775	1.000	1.414	1.732	2.000	2.449	2.828	3.162	3.464	4.000	4.472
63		0.869	1.122	1.587	1.944	2.245	2.750	3.175	3.550	3.888	4.490	5.020
80		0.980	1.265	1.789	2.191	2.530	3.098	3.578	4.000	4.382	5.060	5.657
100		1.095	1.414	2.000	2.449	2.828	3.464	4.000	4.472	4.899	5.657	6.325
125	1.225	1.581	2.236	2.739	3.162	3.873	4.472	5.000	5.477	6.325	7.071	

RE

μm

3 5 10 15 20 30 40 50 60 80 100

6.0



0.379 0.490 0.693 0.849 0.980 1.200 1.386 1.549 1.697 1.960 2.191

i

ODKT 05

ODMT 05

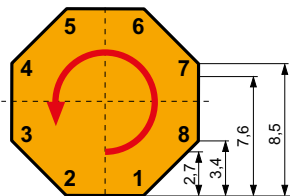

a_p	
→ 2.7	8
→ 3.4	7
→ 7.6	4
→ 8.5	2

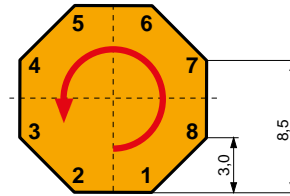

a_p	
→ 3.0	8
→ 8.5	4



SOD06D

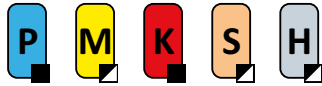

PRAMET

S



Universal Face Mill with Positive Design and Internal Coolant

Highly productive universal face mill utilising single sided positive inserts with APMX of up to 3.5 mm. Unique insert seat fits OD.. 06 and RP.. 15 style inserts, suited for face milling and chamfering. Arbor style only in range from Ø63 up to Ø160 mm with differential tooth pitch. Body treated for longer tool life.

KAPR	45°
APMX	3.1 (8.6) mm

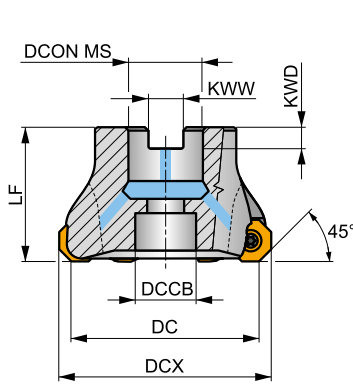
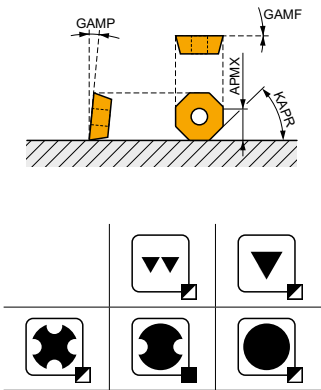

DC 63 - 125 mm

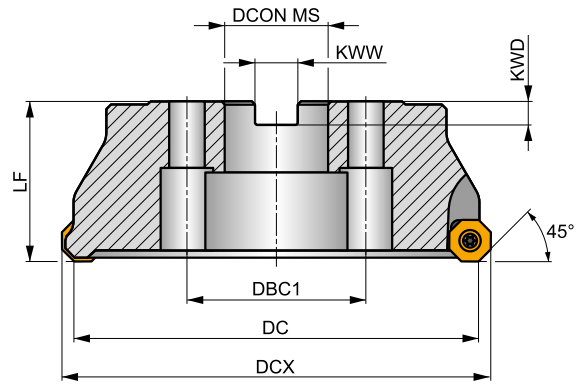

DC 160 mm

0.12 - 0.22



Product	DC	DCX	LF	DCON MS	DCCB	DBC1	KWW	KWD	GAMF	GAMP							
	[mm]	[mm]	[mm]	[mm]	[mm]	[mm]	[mm]	[mm]	[°]	[°]					kg		
63A05R-S450D06D	63	72.5	40	22	18	-	10.4	6.3	0	5	5	✓	8800	✓	0.60	GI059	FA071
80A06R-S450D06D	80	89.5	50	27	20	-	12.4	7	0	5	6	✓	7800	✓	1.25	GI059	FA071
100A07R-S450D06D	100	109.5	50	32	27	-	14.4	8	0	5	7	✓	7000	✓	2.09	GI059	FA071
125A08R-S450D06D	125	134.5	63	40	33	-	16.4	9	0	5	8	✓	6300	✓	4.18	GI059	FA071
160C09R-S450D06D	160	169.5	63	40	56	66.7	16.4	9	0	5	9	✓	5500	-	6.49	GI059	FA071

GI059	OD.. 0605ZZ..	RP.. 1505M0..

FA071	US 4511-T20	5.0 Nm	M 4.5	11	SDR T20-T



ODMT 06

	IC	D1	S
	[mm]	[mm]	[mm]
0605	15.875	5.50	5.56

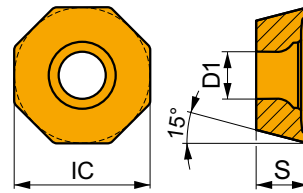

Suitability and starting values for cutting speed (vc), feed (f) and depth of cut (ap). Refer to our Machining Calculator app for further calculations.

Product	RE	P			M			K			N			S			H		
		vc	f	ap	vc	f	ap	vc	f	ap	vc	f	ap	vc	f	ap	vc	f	ap
	[mm]	[m/min]	[mm/tooth]	[mm]	[m/min]	[mm/tooth]	[mm]	[m/min]	[mm/tooth]	[mm]	[m/min]	[mm/tooth]	[mm]	[m/min]	[mm/tooth]	[mm]	[m/min]	[mm/tooth]	[mm]

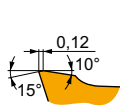

Slightly positive design, 45° face milling insert, for medium machining.

ODMT 0605ZZN	M5315	-	✓	255	0.24	3.0		-	-	-	■	240	0.24	3.0		-	-	-		-	-	-
	M8330	-	■	200	0.24	3.0		-	-	-	■	190	0.24	3.0		-	-	-		-	-	-
	M8340	-	■	185	0.24	3.0		-	-	-	✓	175	0.24	3.0		-	-	-		-	-	-
	M9315	-	■	260	0.24	3.0		-	-	-	■	245	0.24	3.0		-	-	-		-	-	-
	M9325	-	■	245	0.24	3.0		-	-	-	■	230	0.24	3.0		-	-	-		-	-	-

ODEW 06

	IC	D1	S
	[mm]	[mm]	[mm]
0605	15.875	5.50	5.56

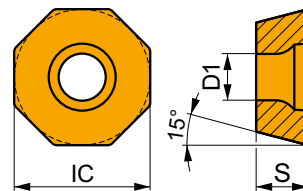

Suitability and starting values for cutting speed (vc), feed (f) and depth of cut (ap). Refer to our Machining Calculator app for further calculations.

Product	RE	P			M			K			N			S			H		
		vc	f	ap	vc	f	ap	vc	f	ap	vc	f	ap	vc	f	ap	vc	f	ap
	[mm]	[m/min]	[mm/tooth]	[mm]	[m/min]	[mm/tooth]	[mm]	[m/min]	[mm/tooth]	[mm]	[m/min]	[mm/tooth]	[mm]	[m/min]	[mm/tooth]	[mm]	[m/min]	[mm/tooth]	[mm]

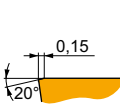

Zero rake angle design, 45° face milling insert, for medium machining.

ODEW 0605ZZN	M8330	-	✓	210	0.26	2.5		-	-	-	■	195	0.26	2.5		-	-	-	■	40	0.15	1.0
--------------	-------	---	---	-----	------	-----	--	---	---	---	---	-----	------	-----	--	---	---	---	---	----	------	-----



ODMX 06

	IC	D1	S
	[mm]	[mm]	[mm]
0605	15.875	5.50	5.56

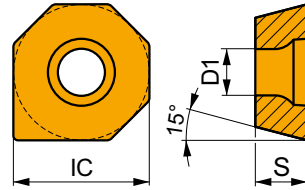

Suitability and starting values for cutting speed (vc), feed (f) and depth of cut (ap). Refer to our Machining Calculator app for further calculations.

Product	RE	P			M			K			N			S			H		
		vc	f	ap	vc	f	ap	vc	f	ap	vc	f	ap	vc	f	ap	vc	f	ap
	[mm]	[m/min]	[mm/tooth]	[mm]	[m/min]	[mm/tooth]	[mm]	[m/min]	[mm/tooth]	[mm]	[m/min]	[mm/tooth]	[mm]	[m/min]	[mm/tooth]	[mm]	[m/min]	[mm/tooth]	[mm]

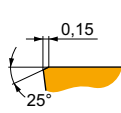

Wiper design for improved surface finish.

ODMX 0605ZZ	M8330	-	205	0.28	2.5	-	-	-	190	0.28	2.5	-	-	-	-	-	-	40	0.15	1.0
--------------------	--------------	---	-----	------	-----	---	---	---	-----	------	-----	---	---	---	---	---	---	----	------	-----

RPET 15

	INSD	D1	S
	[mm]	[mm]	[mm]
1505	15.8	5.50	5.56

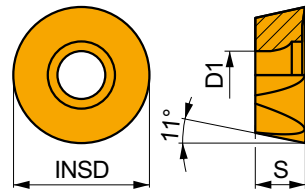

Suitability and starting values for cutting speed (vc), feed (f) and depth of cut (ap). Refer to our Machining Calculator app for further calculations.

Product	RE	P			M			K			N			S			H		
		vc	f	ap	vc	f	ap	vc	f	ap	vc	f	ap	vc	f	ap	vc	f	ap
	[mm]	[m/min]	[mm/tooth]	[mm]	[m/min]	[mm/tooth]	[mm]	[m/min]	[mm/tooth]	[mm]	[m/min]	[mm/tooth]	[mm]	[m/min]	[mm/tooth]	[mm]	[m/min]	[mm/tooth]	[mm]

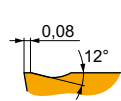

M geometry, copy and profile mill insert, with positive design for light to rough machining.

RPET 1505MOS-M	M8330	-	230	0.40	1.0	135	0.36	1.0	215	0.40	1.0	-	-	-	55	0.28	0.8	-	-	-
	M8340	-	210	0.40	1.0	125	0.36	1.0	195	0.40	1.0	-	-	-	50	0.28	0.8	-	-	-



RPEW 15

	INSD	D1	S
	[mm]	[mm]	[mm]
1505	15.8	5.50	5.56

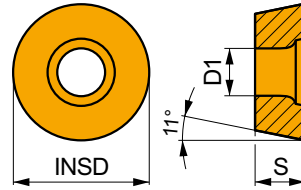

Suitability and starting values for cutting speed (vc), feed (f) and depth of cut (ap). Refer to our Machining Calculator app for further calculations.

Product	RE	P			M			K			N			S			H		
		vc	f	ap	vc	f	ap	vc	f	ap	vc	f	ap	vc	f	ap	vc	f	ap
	[mm]	[m/min]	[mm/tooth]	[mm]	[m/min]	[mm/tooth]	[mm]	[m/min]	[mm/tooth]	[mm]	[m/min]	[mm/tooth]	[mm]	[m/min]	[mm/tooth]	[mm]	[m/min]	[mm/tooth]	[mm]

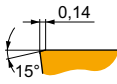

Zero rake angle design, copy and profile mill insert, for medium machining.

RPEW 1505MOS	M8330	-	300	0.20	1.0	-	-	-	285	0.20	1.0	-	-	-	-	-	60	0.15	1.0
--------------	-------	---	-----	------	-----	---	---	---	-----	------	-----	---	---	---	---	---	----	------	-----



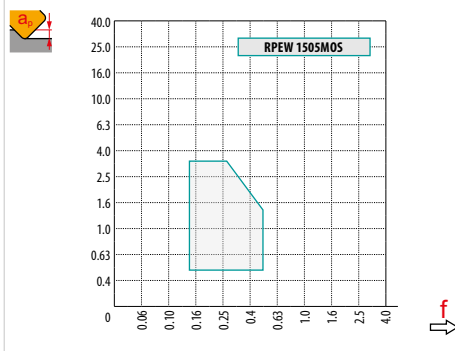
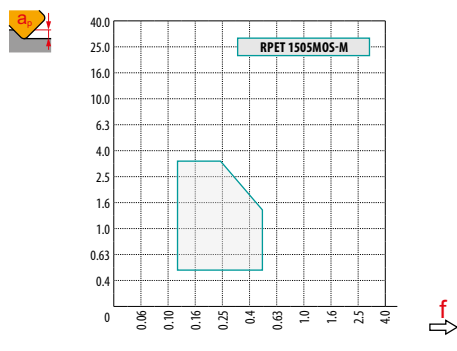
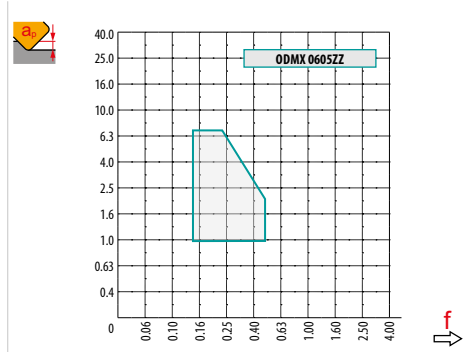
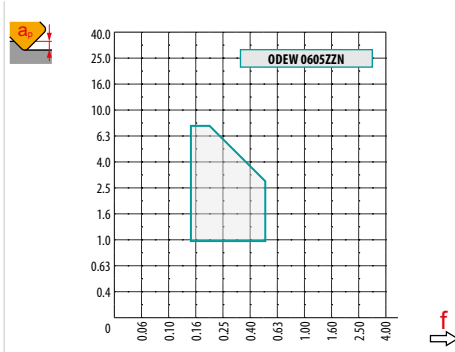
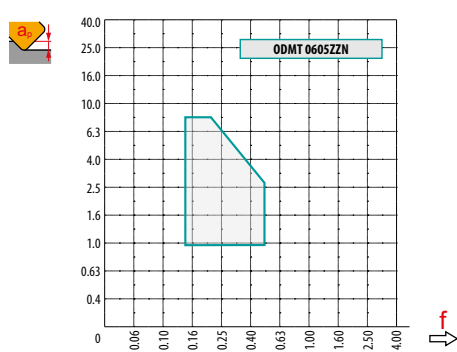

a_e / DC	5 %	10 %	15 %	20 %	25 %	30 %	40 %	50 %	60 %	70 %	75 %	80 %	90 %	100 %
	1.48	1.35	1.27	1.22	1.19	1.16	1.11	1.08	1.05	1.03	1.00	1.00	1.00	1.00
	2.20	1.60	1.35	1.20	1.10	0.95	0.85	0.75	0.85	0.95	1.00	1.00	1.00	1.00
	0.64	0.64	0.64	0.64	0.64	0.65	0.65	0.67	0.68	0.71	0.72	0.74	0.79	1.00

	ODMT 06	OEW 06	ODMX 06	RPET 15-M	RPEW 15
	-	-	-	7.89	7.89
	1.73	5.92	9.91	-	-





		R								
		0.00	0.50	0.75	1.25	1.50	2.00	2.50	3.00	4.00
63		56.63	62.17	63.36	65.18	65.91	67.16	68.19	69.05	70.41
80		73.63	79.17	80.36	82.18	82.91	84.16	85.19	86.05	87.41
100		93.63	99.17	100.36	102.18	102.91	104.16	105.19	106.05	107.41
125		118.63	124.17	125.36	127.18	127.91	129.16	130.19	131.05	132.41
160		153.63	159.17	160.36	162.18	162.91	164.16	165.19	166.05	167.41

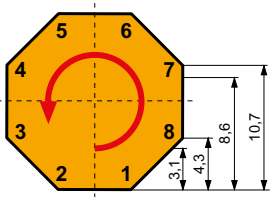

		
63	1.49	0.78
80	1.54	0.88
100	1.59	0.98
125	1.64	1.10
160	1.70	1.24



	
-> 3.1	8
-> 4.3	7
-> 8.6	4
-> 10.7	2



SOE06Z

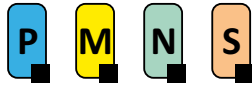

PRAMET

S



Universal Face Mill with Positive Design and Internal Coolant

Highly productive universal face mill utilising positive single sided inserts with APMX of 4 mm for RE.. 16. Unique insert seat fits OE.. 06, RE.. 16 and XE.. 06 style inserts, suited for a wide range of applications. Arbor style only in range from Ø50 up to Ø200 mm with differential tooth pitch. Body treated for longer tool life.

KAPR	43°
APMX	3.3 (9.9) mm

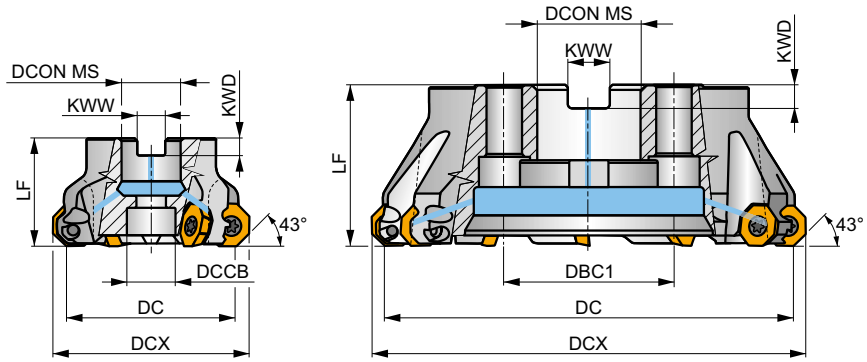
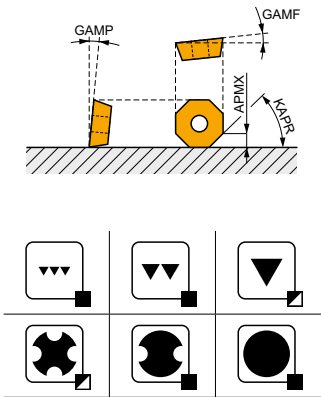

DC 50 – 125 mm

DC 160 – 200 mm

0.06 - 0.20



Product	DC	DCX	LF	DCON MS	DCCB	DBC1	KWW	KWD	GAMF	GAMP	max.		kg	G1283	FA053	-		
	[mm]	[mm]	[mm]	[mm]	[mm]	[mm]	[mm]	[mm]	[°]	[°]								
50A04R-S450E06Z-C	50	60.2	40	22	18	-	10.4	6.3	6	10	4	✓	10700	✓	0.48	G1283	FA053	-
50A05R-S450E06Z-C	50	60	40	22	18	-	10.4	6.3	1	10	5	✓	10700	✓	0.48	G1283	FA053	-
56A05R-S450E06Z-C	56	66	40	22	18	-	10.4	6.3	6	10	5	✓	10100	✓	0.54	G1283	FA053	-
63A04R-S450E06Z-C	63	73.2	40	22	18	-	10.4	6.3	6	10	4	✓	9600	✓	0.59	G1283	FA053	-
63A06R-S450E06Z-C	63	73	40	22	18	-	10.4	6.3	1	10	6	✓	9600	✓	0.61	G1283	FA053	-
70A06R-S450E06Z-C	70	80	40	22	18	-	10.4	6.3	6	10	6	✓	9100	✓	0.69	G1283	FA053	-
80A05R-S450E06Z-C	80	90.2	50	27	38	-	12.4	7	6	10	5	✓	8500	✓	1.03	G1283	FA051	AC001
80A06R-S450E06Z-C	80	90.2	50	27	38	-	12.4	7	6	10	6	✓	8500	✓	1.07	G1283	FA051	AC001
90A07R-S450E06Z-C	90	100	50	32	45	-	14.4	8	6	10	7	✓	8000	✓	1.63	G1283	FA051	AC002
100A06R-S450E06Z-C	100	110.2	50	32	45	-	14.4	8	6	10	6	✓	7600	✓	1.90	G1283	FA051	AC002
100A08R-S450E06Z-C	100	109.9	50	32	45	-	14.4	8	1	10	8	✓	7600	✓	1.92	G1283	FA051	AC002
125A07R-S450E06Z-C	125	135.2	63	40	56	-	16.4	9	6	10	7	✓	6800	✓	3.35	G1283	FA051	AC003
125A09R-S450E06Z-C	125	134.9	63	40	56	-	16.4	9	1	10	9	✓	6800	✓	3.35	G1283	FA051	AC003
160C09R-S450E06Z-C	160	170.2	63	40	-	66.7	16.4	9	6	10	9	✓	6000	✓	7.11	G1283	FA056	-
160C12R-S450E06Z-C	160	169.9	63	40	-	66.7	16.4	9	1	10	12	✓	6000	✓	7.06	G1283	FA056	-
200C11R-S450E06Z-C	200	210.2	63	60	-	101.6	25.7	14	6	10	11	✓	5300	✓	10.80	G1283	FA057	-
200C14R-S450E06Z-C	200	209.9	63	60	-	101.6	25.7	14	1	10	14	✓	5300	✓	11.17	G1283	FA057	-

G1283	OEHT 0604AE..	REHT 1604M0..	XEHT 0604AE..

FA051	US 5011-T20P	5.0	M 5	11	SDRT20P-T	-	-	-	-
FA053	US 5011-T20P	5.0	M 5	11	SDRT20P-T	HS 1030C	-	-	-



FA056	US 5011-T20P	5.0	M 5	11	SDR T20P-T	HS 1240C	CAC 160C	HSD 0825C	HXX 5
FA057	US 5011-T20P	5.0	M 5	11	SDR T20P-T	HS 1655C	CAC 200C	HSD 1025C	HXX 7

AC001	KS 1230	K.FMH27
AC002	KS 1635	K.FMH32
AC003	KS 2040	K.FMH40

OEHT 06



	IC	D1	S
	[mm]	[mm]	[mm]
0604	16.050	5.50	4.76

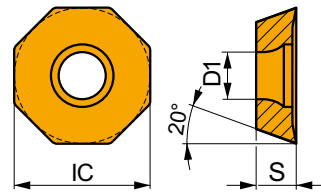

Suitability and starting values for cutting speed (vc), feed (f) and depth of cut (ap). Refer to our Machining Calculator app for further calculations.

Product	RE	P			M			K			N			S			H		
		vc	f	ap	vc	f	ap	vc	f	ap	vc	f	ap	vc	f	ap	vc	f	ap
	[mm]	[m/min]	[mm/tooth]	[mm]	[m/min]	[mm/tooth]	[mm]	[m/min]	[mm/tooth]	[mm]	[m/min]	[mm/tooth]	[mm]	[m/min]	[mm/tooth]	[mm]	[m/min]	[mm/tooth]	[mm]

MF geometry, 45° face milling insert, with sharp positive design for light to medium and potentially finish machining.

OEHT 0604AEER-MF	M6330	–	✓	255	0.12	2.2	■	180	0.11	2.2	–	–	–	–	–	–	■	75	0.10	1.8	–	–	–	
	M8330	–	✓	295	0.12	2.2	■	175	0.11	2.2	–	–	–	✓	885	0.14	2.2	✓	70	0.10	1.8	–	–	–
	M8340	–	✓	275	0.12	2.2	■	165	0.11	2.2	–	–	–	–	–	–	–	■	65	0.10	1.8	–	–	–

MM geometry, 45° face milling insert, with sharp positive design for light to medium machining.

OEHT 0604AEER-MM	M6330	–	✓	245	0.16	2.2	■	170	0.14	2.2	–	–	–	–	–	–	■	70	0.11	1.8	–	–	–	
	M8330	–	✓	280	0.16	2.2	■	165	0.14	2.2	–	–	–	✓	840	0.19	2.2	✓	70	0.11	1.8	–	–	–
	M8340	–	✓	255	0.16	2.2	■	150	0.14	2.2	–	–	–	–	–	–	–	■	60	0.11	1.8	–	–	–
	M8345	–	✓	205	0.16	2.2	■	120	0.14	2.2	–	–	–	–	–	–	–	■	50	0.11	1.8	–	–	–
	M9325	–	✓	355	0.16	2.2	■	–	–	–	–	–	–	–	–	–	–	–	–	–	–	–	–	–
	M9340	–	✓	320	0.16	2.2	■	190	0.14	2.2	–	–	–	–	–	–	–	■	80	0.11	1.8	–	–	–

M geometry, 45° face milling insert, with slightly positive design for light to medium machining.

OEHT 0604AESR-M	M6330	–	■	210	0.24	3.2	■	150	0.22	3.2	–	–	–	–	–	–	✓	60	0.17	2.6	–	–	–	
	M8310	–	■	265	0.24	3.2	✓	135	0.22	3.2	–	–	–	–	–	–	–	–	–	–	–	–	–	
	M8330	–	■	245	0.24	3.2	■	145	0.22	3.2	–	–	–	–	–	–	–	✓	60	0.17	2.6	–	–	–
	M8340	–	■	220	0.24	3.2	■	130	0.22	3.2	–	–	–	–	–	–	–	✓	55	0.17	2.6	–	–	–
	M9325	–	■	295	0.24	3.2	■	–	–	–	–	–	–	–	–	–	–	–	–	–	–	–	–	–
	M9340	–	■	270	0.24	3.2	■	160	0.22	3.2	–	–	–	–	–	–	–	✓	65	0.17	2.6	–	–	–



OEHT 06-FA

PRAMET

	IC	D1	S
	[mm]	[mm]	[mm]
0604	16.050	5.50	4.76

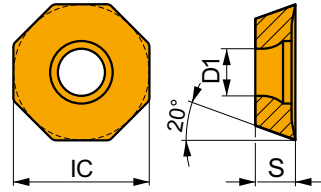

Suitability and starting values for cutting speed (vc), feed (f) and depth of cut (ap). Refer to our Machining Calculator app for further calculations.

Product	RE	P			M			K			N			S			H		
		vc	f	ap	vc	f	ap	vc	f	ap	vc	f	ap	vc	f	ap	vc	f	ap
	[mm]	[m/min]	[mm/tooth]	[mm]	[m/min]	[mm/tooth]	[mm]	[m/min]	[mm/tooth]	[mm]	[m/min]	[mm/tooth]	[mm]	[m/min]	[mm/tooth]	[mm]	[m/min]	[mm/tooth]	[mm]

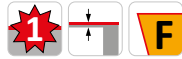
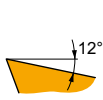

FA geometry, 45° face milling insert, with highly positive design for fine-finish to medium machining.

OEHT 0604AEFR-FA	HF7	-	-	-	-	-	-	-	-	■	330	0.18	2.0	-	-	-	-	-	-
	M0315	-	-	-	-	-	-	-	-	■	765	0.18	2.0	-	-	-	-	-	-

XEHT 06

PRAMET

	IC	D1	S
	[mm]	[mm]	[mm]
0604	16.050	5.50	4.76

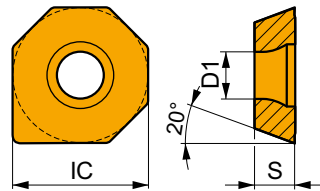

Suitability and starting values for cutting speed (vc), feed (f) and depth of cut (ap). Refer to our Machining Calculator app for further calculations.

Product	RE	P			M			K			N			S			H		
		vc	f	ap	vc	f	ap	vc	f	ap	vc	f	ap	vc	f	ap	vc	f	ap
	[mm]	[m/min]	[mm/tooth]	[mm]	[m/min]	[mm/tooth]	[mm]	[m/min]	[mm/tooth]	[mm]	[m/min]	[mm/tooth]	[mm]	[m/min]	[mm/tooth]	[mm]	[m/min]	[mm/tooth]	[mm]

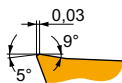

Slightly positive wiper design for improved surface finish.

XEHT 0604AESR	M8310	-	■	265	0.24	3.2	☑	135	0.22	3.2	-	-	-	-	-	-	-	-	-
	M8330	-	■	245	0.24	3.2	☑	145	0.22	3.2	-	-	-	-	-	-	-	-	-



REHT 16

	INSD	D1	S
	[mm]	[mm]	[mm]
1604	16.0	5.50	4.76

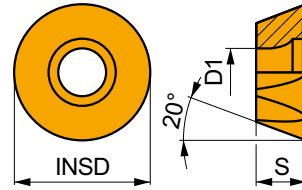

Suitability and starting values for cutting speed (vc), feed (f) and depth of cut (ap). Refer to our Machining Calculator app for further calculations.

Product	RE	P			M			K			N			S			H		
		vc	f	ap	vc	f	ap	vc	f	ap	vc	f	ap	vc	f	ap	vc	f	ap
	[mm]	[m/min]	[mm/tooth]	[mm]	[m/min]	[mm/tooth]	[mm]	[m/min]	[mm/tooth]	[mm]	[m/min]	[mm/tooth]	[mm]	[m/min]	[mm/tooth]	[mm]	[m/min]	[mm/tooth]	[mm]

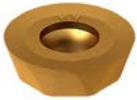

MM geometry, copy and profile mill insert, with slightly positive design for light to medium machining.

REHT 1604M0EN-MM	M6330	-	240	0.25	2.0	170	0.23	2.0	-	-	-	-	-	-	70	0.18	1.6	-	-	-	
	M8330	-	280	0.25	2.0	165	0.23	2.0	-	-	-	840	0.30	2.0	70	0.18	1.6	-	-	-	
	M8340	-	255	0.25	2.0	150	0.23	2.0	-	-	-	-	-	-	60	0.18	1.6	-	-	-	
	M8345	-	205	0.25	2.0	120	0.23	2.0	-	-	-	-	-	-	50	0.18	1.6	-	-	-	
	M9325	-	340	0.25	2.0	-	-	-	-	-	-	-	-	-	-	-	-	-	-	-	-
	M9340	-	305	0.25	2.0	180	0.23	2.0	-	-	-	-	-	-	75	0.18	1.6	-	-	-	

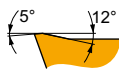

M geometry, copy and profile mill insert, with positive design for light to medium machining.

REHT 1604M0SN-M	M8310	-	275	0.35	2.0	140	0.32	2.0	-	-	-	-	-	-	-	-	-	-	-	-
	M8330	-	260	0.35	2.0	155	0.32	2.0	-	-	-	-	-	65	0.25	1.6	-	-	-	
	M8340	-	240	0.35	2.0	140	0.32	2.0	-	-	-	-	-	60	0.25	1.6	-	-	-	
	M9325	-	310	0.35	2.0	-	-	-	-	-	-	-	-	-	-	-	-	-	-	-





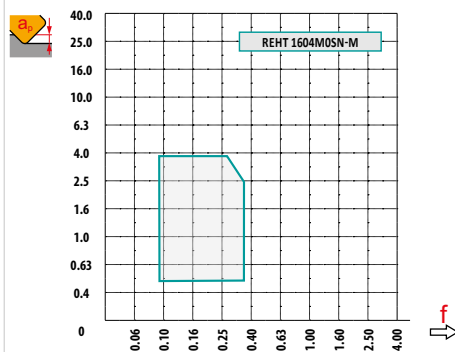
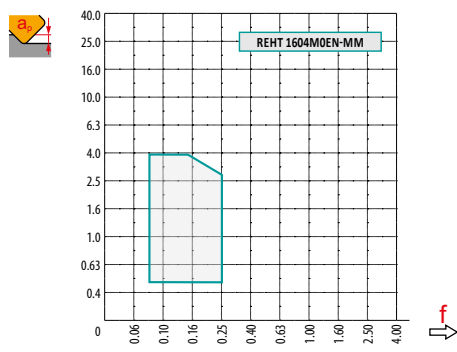
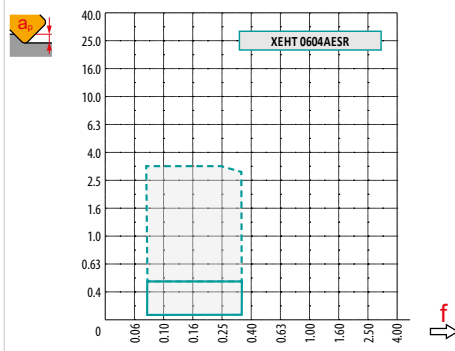
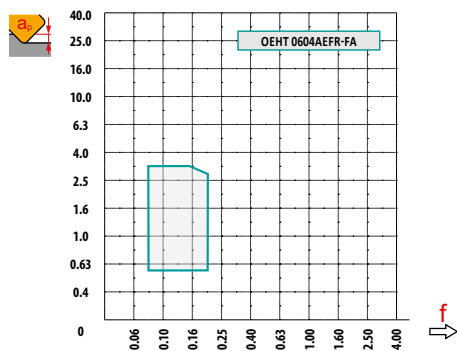
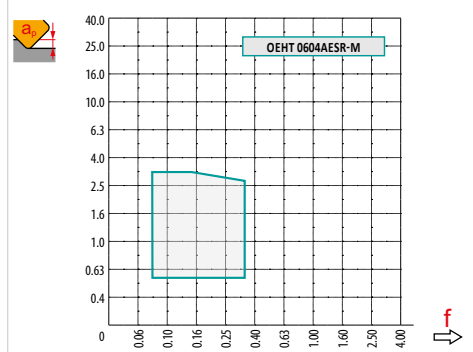
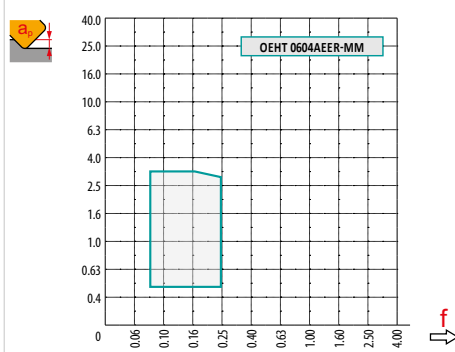
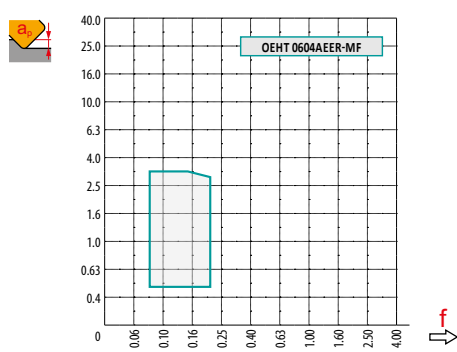

a_e / DC	5 %	10 %	15 %	20 %	25 %	30 %	40 %	50 %	60 %	70 %	75 %	80 %	90 %	100 %
	1.48	1.35	1.27	1.22	1.19	1.16	1.11	1.08	1.05	1.03	1.00	1.00	1.00	1.00
	2.20	1.60	1.35	1.20	1.10	0.95	0.85	0.75	0.85	0.95	1.00	1.00	1.00	1.00
	0.64	0.64	0.64	0.64	0.64	0.65	0.65	0.67	0.68	0.71	0.72	0.74	0.79	1.00



	OEHT 06-MF	OEHT 06-MM	OEHT 06-M	OEHT 06-FA	XEHT 06	REHT 16-MM	REHT 16-M
	-	-	-	-	-	8.00	8.00
	1.36	1.36	1.36	1.36	9.91	-	-











										
		0.00	0.50	0.75	1.25	1.50	2.00	2.50	3.00	4.00
50		43.90	49.47	50.66	52.49	53.23	54.48	55.52	56.39	57.76
56		49.80	55.37	56.56	58.39	59.13	60.38	61.42	62.29	63.66
63		56.90	62.47	63.66	65.49	66.23	67.48	68.52	69.39	70.76
70		63.80	69.37	70.56	72.39	73.13	74.38	75.42	76.29	77.66
80		73.90	79.47	80.66	82.49	83.23	84.48	85.52	86.39	87.76
90		83.80	89.37	90.56	92.39	93.13	94.38	95.42	96.29	97.66
100		93.90	99.47	100.66	102.49	103.23	104.48	105.52	106.39	107.76
125		118.90	124.47	125.66	127.49	128.23	129.48	130.52	131.39	132.76
160		153.90	159.47	160.66	162.49	163.23	164.48	165.52	166.39	167.76
200		193.90	199.47	200.66	202.49	203.23	204.48	205.52	206.39	207.76









		
50	1.43	0.33
56	1.45	0.35
63	1.47	0.37
70	1.49	0.39
80	1.52	0.42
90	1.55	0.44
100	1.57	0.47
125	1.62	0.52
160	1.68	0.59
200	1.73	0.66





					
		RPMX	APMX/l	RPMX	APMX/l
50	59.9	4.9	8.4/100	4.6	7.9/100
56	65.8	4.2	7.2/100	4	6.8/100
63	72.9	3.6	6.1/100	3	5.1/100
70	79.8	3.1	5.3/100	2.7	4.6/100
80	89.9	2.6	4.4/100	2.2	3.7/100
90	99.8	2.3	3.9/100	2	3.3/100
100	109.9	2	3.3/100	1.8	3.0/100
125	134.9	1.5	2.5/100	1.3	2.1/100



	
	
50	59.9
56	65.8
63	72.9
70	79.8
80	89.9
90	99.8
100	109.9
125	134.9

			
DMIN	DMAX		
91.5	120.0	5.9	5.9
103.2	131.5	5.9	5.9
117.4	146.0	5.9	5.9
131.2	159.5	5.9	5.9
151.4	180.0	5.9	5.9
171.2	199.5	5.9	5.9
191.4	220.0	5.9	5.9
241.3	270.0	5.9	5.9

			
DMIN	DMAX		
91.5	119.5	5.9	5.9
103.5	131.0	5.9	5.9
118.0	145.5	5.9	5.9
131.5	159.0	5.9	5.9
151.5	179.5	5.9	5.9
171.5	199.0	5.9	5.9
191.5	219.5	5.9	5.9
241.5	269.5	5.9	5.9



		
	3.1	3.0

**R**

	μm	3	5	10	15	20	30	40	50	60	80	100
59.9		0.848	1.095	1.548	1.896	2.189	2.681	3.096	3.461	3.792	4.378	4.895
65.8		0.889	1.147	1.622	1.987	2.294	2.810	3.245	3.628	3.974	4.589	5.130
72.9		0.935	1.207	1.708	2.091	2.415	2.958	3.415	3.818	4.183	4.830	5.400
79.8		0.979	1.263	1.787	2.188	2.527	3.095	3.573	3.995	4.376	5.053	5.650
89.9		1.039	1.341	1.896	2.322	2.682	3.285	3.793	4.240	4.645	5.364	5.997
99.8		1.094	1.413	1.998	2.447	2.826	3.461	3.996	4.468	4.894	5.651	6.318

	μm	3	5	10	15	20	30	40	50	60	80	100
8.0		0.438	0.566	0.800	0.980	1.131	1.386	1.600	1.789	1.960	2.263	2.530

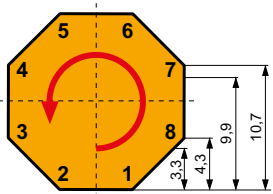
i

→ 3.3	8
→ 4.3	7
→ 9.9	4
→ 10.7	2

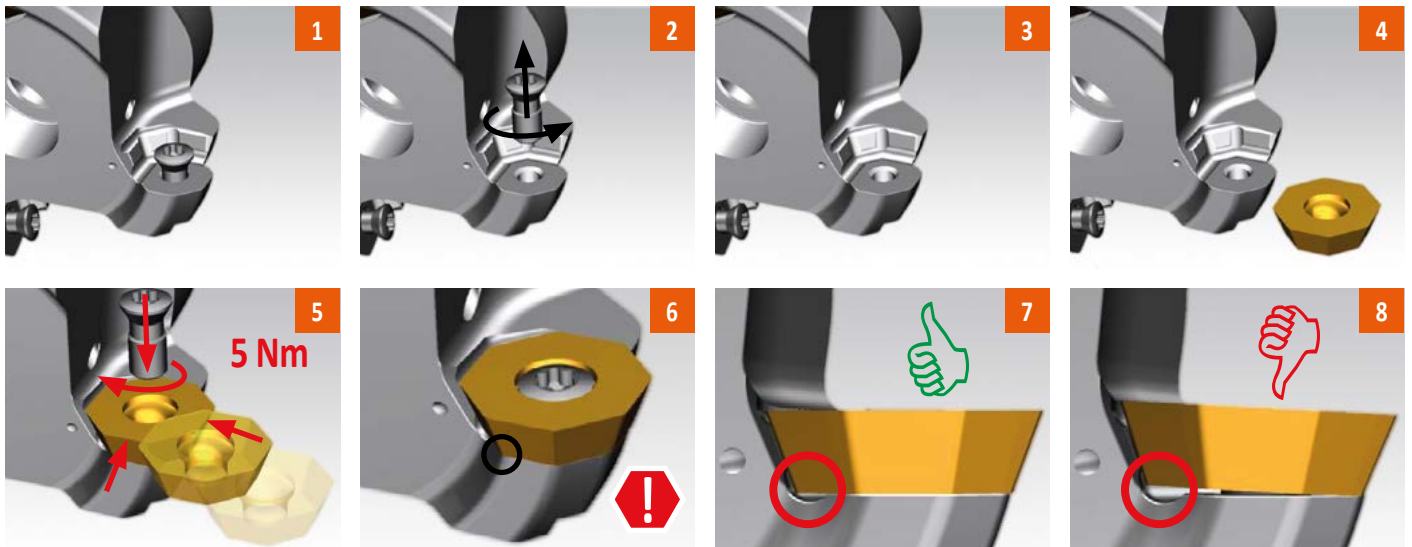



SOE09Z

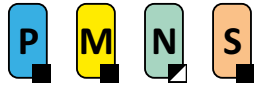

PRAMET

S



Universal Face Mill with Positive Design and Internal Coolant

Highly productive universal face mill utilising positive single sided inserts with APMX of 6 mm for RE.. 24. Unique insert seat fits OE.. 09, RE.. 24 and XE.. 09 style inserts. Suited for a wide range of applications. Arbor style only in range from Ø80 up to Ø315 mm with differential tooth pitch. Body treated for longer tool life.

KAPR	43°
APMX	5.0 (14.1) mm

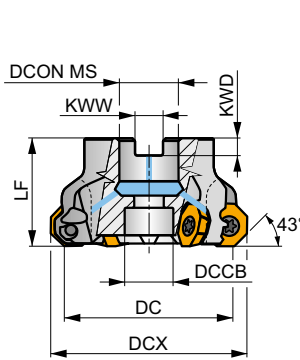
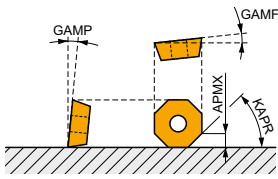

DC 80 – 125 mm

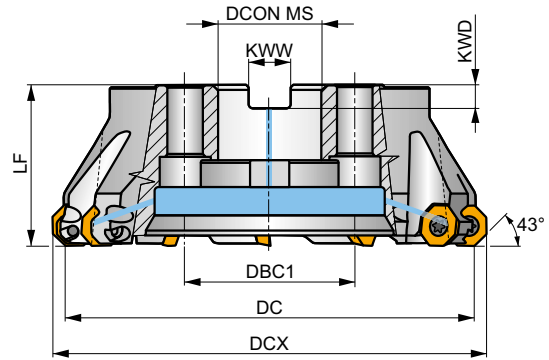

DC 160 – 315 mm

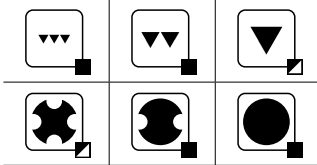

Product	DC	DCX	LF	D CON MS	DCCB	DBC1	KWW	KWD	GAMF	GAMP	Icons		max.	kg	Icons			
	[mm]	[mm]	[mm]	[mm]	[mm]	[mm]	[mm]	[mm]	[°]	[°]	Icons	Icons			Icons	Icons		
80A05R-S450E09Z-C	80	95	50	27	22	-	12.4	7	6	10	5	✓	6100	✓	1.32	GI293	FA064	-
100A06R-S450E09Z-C	100	115	50	32	45	-	14.4	8	6	10	6	✓	5400	✓	1.90	GI293	FA061	AC002
125A07R-S450E09Z-C	125	140	63	40	56	-	16.4	9	6	10	7	✓	4800	✓	3.38	GI293	FA061	AC003
160C08R-S450E09Z-C	160	175	63	40	-	66.7	16.4	9	6	10	8	✓	4300	✓	6.12	GI293	FA066	-
200C10R-S450E09Z-C	200	215	63	60	-	101.6	25.7	14	1	10	10	✓	3800	✓	11.50	GI293	FA067	-
250C12R-S450E09Z-C	250	265	63	60	-	101.6	25.7	14	1	10	12	✓	3400	✓	18.50	GI293	FA068	-
315C14R-S450E09Z-C	315	330	80	60	-	101.6	25.7	14	1	10	14	✓	3000	✓	36.00	GI293	FA069	-

GI293	OEHT 0906AE..	REHT 2406M0..	XEHT 0906AE..
-------	---------------	---------------	---------------

Icons	Icons	Nm	Icons	Icons	Icons	Icons	Icons	Icons	Icons	Icons	Icons
FA061	US 68020-T30P	15.0	M 8	20	SDRT30P-T	-	-	-	-	-	-
FA064	US 68020-T30P	15.0	M 8	20	SDRT30P-T	HS 1230C	-	-	-	-	-
FA066	US 68020-T30P	15.0	M 8	20	SDRT30P-T	HS 1240C	CAC 160C	HSD 0825C	HXK 5	-	-
FA067	US 68020-T30P	15.0	M 8	20	SDRT30P-T	HS 1655C	CAC 200C	HSD 1025C	HXK 7	-	-
FA068	US 68020-T30P	15.0	M 8	20	SDRT30P-T	HS 1655C	CAC 250C	HSD 1025C	HXK 7	-	-
FA069	US 68020-T30P	15.0	M 8	20	SDRT30P-T	HS 1655C	CAC 315C	HSD 1035C	HXK 7	CACP 3150C	RRH 34

AC002	KS 1635	K.FMH32
-------	---------	---------



AC003



KS 2040



K.FMH40

OEHT 09



0906

IC

[mm]

24.100

D1

[mm]

8.60

S

[mm]

7.15

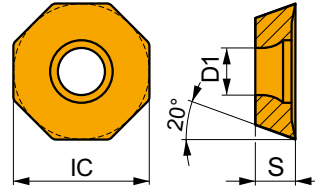

Suitability and starting values for cutting speed (vc), feed (f) and depth of cut (ap). Refer to our Machining Calculator app for further calculations.

Product	RE [mm]	P			M			K			N			S			H		
		vc [m/min]	f [mm/tooth]	ap [mm]	vc [m/min]	f [mm/tooth]	ap [mm]	vc [m/min]	f [mm/tooth]	ap [mm]	vc [m/min]	f [mm/tooth]	ap [mm]	vc [m/min]	f [mm/tooth]	ap [mm]	vc [m/min]	f [mm/tooth]	ap [mm]



MM geometry, 45° face milling insert, with sharp positive design for light to medium and potentially heavy machining.

OEHT 0906AEER-MM	M8330	–	255	0.25	3.5	150	0.23	3.5	–	–	–	765	0.30	3.5	60	0.18	2.8	–	–	–
	M8340	–	230	0.25	3.5	135	0.23	3.5	–	–	–	–	–	–	55	0.18	2.8	–	–	–

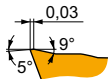

M geometry, 45° face milling insert, with positive design for light to medium and potentially heavy machining.

OEHT 0906AESR-M	M8310	–	250	0.35	3.5	125	0.32	3.5	–	–	–	–	–	–	–	–	–	–	–	–
	M8330	–	235	0.35	3.5	140	0.32	3.5	–	–	–	–	–	–	55	0.25	2.8	–	–	–
	M8340	–	215	0.35	3.5	125	0.32	3.5	–	–	–	–	–	–	50	0.25	2.8	–	–	–
	M9325	–	275	0.35	3.5	–	–	–	–	–	–	–	–	–	–	–	–	–	–	–



XEHT 09

	IC [mm]	D1 [mm]	S [mm]
0906	24.100	8.60	7.15

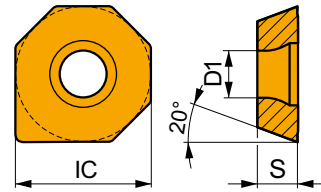

Suitability and starting values for cutting speed (vc), feed (f) and depth of cut (ap). Refer to our Machining Calculator app for further calculations.

Product	RE	P			M			K			N			S			H		
		vc	f	ap	vc	f	ap	vc	f	ap	vc	f	ap	vc	f	ap	vc	f	ap
	[mm]	[m/min]	[mm/tooth]	[mm]	[m/min]	[mm/tooth]	[mm]	[m/min]	[mm/tooth]	[mm]	[m/min]	[mm/tooth]	[mm]	[m/min]	[mm/tooth]	[mm]	[m/min]	[mm/tooth]	[mm]

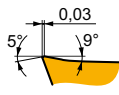

Slightly positive wiper design for improved surface finish.

XEHT 0906AESR	M8310	-	■	235	0.35	3.5	▣	115	0.32	3.5	■	-	-	-	■	-	-	-	■	-	-	-
----------------------	--------------	---	---	-----	------	-----	---	-----	------	-----	---	---	---	---	---	---	---	---	---	---	---	---

REHT 24

	INSD [mm]	D1 [mm]	S [mm]
2406	24.0	8.60	7.15

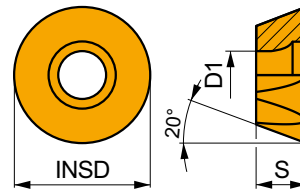

Suitability and starting values for cutting speed (vc), feed (f) and depth of cut (ap). Refer to our Machining Calculator app for further calculations.

Product	RE	P			M			K			N			S			H		
		vc	f	ap	vc	f	ap	vc	f	ap	vc	f	ap	vc	f	ap	vc	f	ap
	[mm]	[m/min]	[mm/tooth]	[mm]	[m/min]	[mm/tooth]	[mm]	[m/min]	[mm/tooth]	[mm]	[m/min]	[mm/tooth]	[mm]	[m/min]	[mm/tooth]	[mm]	[m/min]	[mm/tooth]	[mm]



MM geometry, copy and profile mill insert, with slightly positive design for light to medium and potentially heavy machining.

REHT 2406MOEN-MM	M8330	-	▣	280	0.25	2.0	■	165	0.23	2.0	■	-	-	-	▣	840	0.30	2.0	▣	70	0.18	1.6	■	-	-	-
	M8340	-	▣	255	0.25	2.0	■	150	0.23	2.0	■	-	-	-	■	-	-	-	■	60	0.18	1.6	■	-	-	-

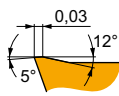

M geometry, copy and profile mill insert, with slightly positive design for light to medium and potentially heavy machining.

REHT 2406M0SN-M	M8330	-	■	260	0.35	2.0	■	155	0.32	2.0	■	-	-	-	▣	65	0.25	1.6	■	-	-	-	■	-	-	-
	M8340	-	■	240	0.35	2.0	■	140	0.32	2.0	■	-	-	-	▣	60	0.25	1.6	■	-	-	-	■	-	-	-



a_e / DC	5 %	10 %	15 %	20 %	25 %	30 %	40 %	50 %	60 %	70 %	75 %	80 %	90 %	100 %
	1.48	1.35	1.27	1.22	1.19	1.16	1.11	1.08	1.05	1.03	1.00	1.00	1.00	1.00
	2.20	1.60	1.35	1.20	1.10	0.95	0.85	0.75	0.85	0.95	1.00	1.00	1.00	1.00
	0.64	0.64	0.64	0.64	0.64	0.65	0.65	0.67	0.68	0.71	0.72	0.74	0.79	1.00

	OEHT 09-MM	OEHT 09-M	XEHT 09	REHT 24-MM	REHT 24-M
	-	-	-	12.00	12.00
	2.00	2.00	14.80	-	-

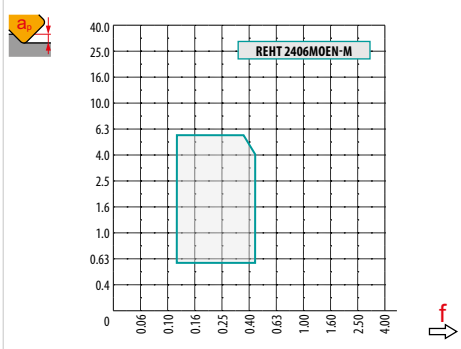
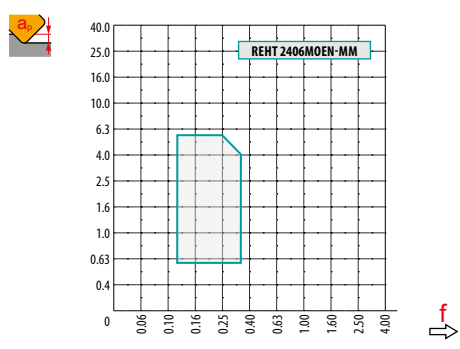
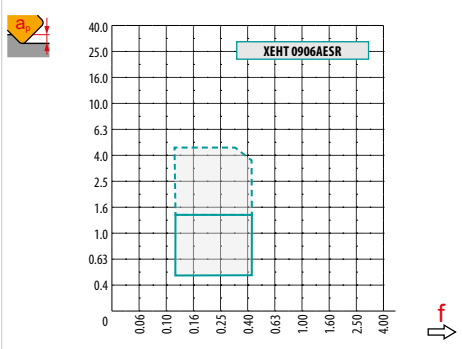
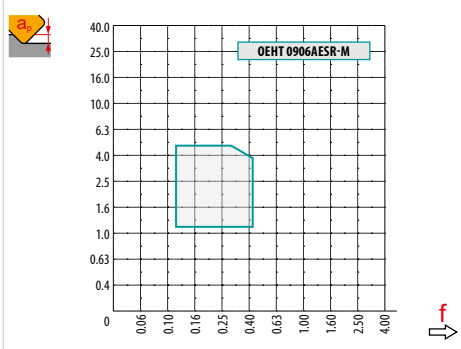
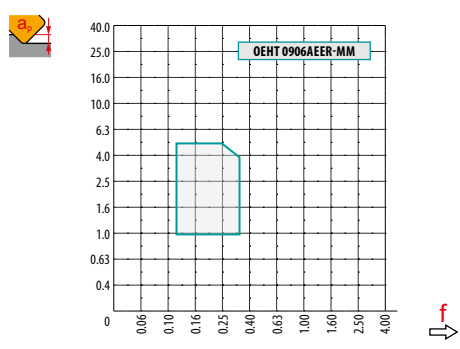

		0.00	0.50	0.75	1.25	1.50	2.00	2.50	3.00	4.00	5.00	6.00
80		70.90	77.76	79.25	81.57	82.52	84.17	85.56	86.77	88.79	90.39	91.68
100		90.90	97.76	99.25	101.57	102.52	104.17	105.56	106.77	108.79	110.39	111.68
125		115.90	122.76	124.25	126.57	127.52	129.17	130.56	131.77	133.79	135.39	136.68
160		150.90	157.76	159.25	161.57	162.52	164.17	165.56	166.77	168.79	170.39	171.68
200		190.90	197.76	199.25	201.57	202.52	204.17	205.56	206.77	208.79	210.39	211.68
250		240.60	247.46	248.95	251.27	252.22	253.87	255.26	256.47	258.49	260.09	261.38
315	305.60	312.46	313.95	316.27	317.22	318.87	320.26	321.47	323.49	325.09	326.38	



		f_{max}
80	1.44	0.51
100	1.48	0.57
125	1.53	0.64
160	1.58	0.72
200	1.63	0.80
250	1.68	0.90
315	1.74	1.01



		RPMX	APMX/I	RPMX	APMX/I
80	94.9	4.9	8.4/100	5.0	8.6/100
100	114.9	3.7	6.3/100	3.7	6.3/100
125	139.9	2.8	4.7/100	2.8	4.7/100
160	174.9	2.1	3.5/100	2.1	3.5/100
200	214.9	1.6	2.6/100	1.6	2.6/100



		DMIN	DMAX			DMIN	DMAX		
80	94.9	146.0	190.0	8.8	8.8	146.0	189.0	11.5	11.5
100	114.9	186.0	230.0	8.8	8.8	186.0	229.0	11.5	11.5
125	139.9	236.0	280.0	8.8	8.8	236.0	279.0	11.5	11.5
160	174.9	306.0	350.0	8.8	8.8	306.0	349.0	11.5	11.5
200	214.9	386.0	430.0	8.8	8.8	386.0	429.0	11.5	11.5



	5.5	5.4



R

DCX	μm	3	5	10	15	20	30	40	50	60	80	100
94.9	FE	1.067	1.378	1.948	2.386	2.755	3.375	3.897	4.357	4.772	5.511	6.161

RE	μm	3	5	10	15	20	30	40	50	60	80	100
12.0	FE	0.537	0.693	0.980	1.200	1.386	1.697	1.960	2.191	2.400	2.771	3.098

i

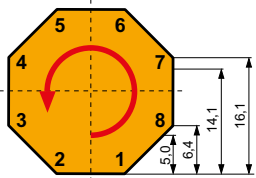

a	
-> 5.0	8
-> 6.4	7
-> 14.1	4
-> 16.1	2

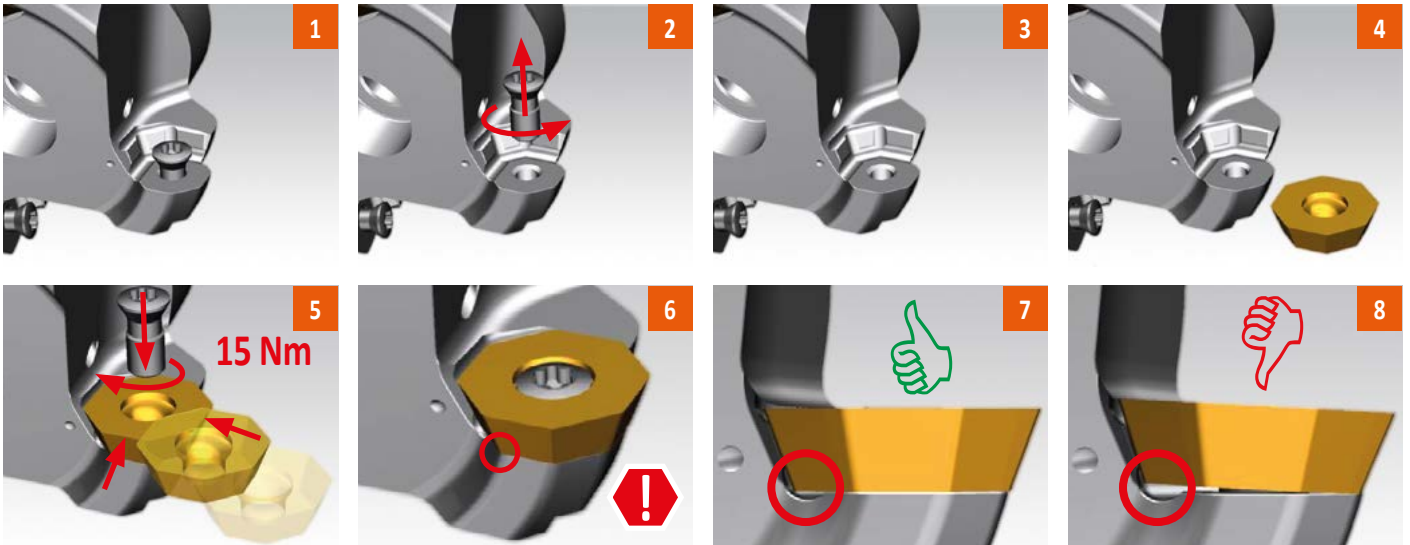



SSE09



PRAMET

S



45° Face Mill with Positive Design and Internal Coolant

Highly productive 45° face mill utilising single sided SE.. 09 style inserts with APMX of 4.5 mm. Suited for face milling and chamfering. Weldon and arbor style available, in range from Ø20 up to Ø160 mm and with differential tooth pitch. Body treated for longer tool life.

KAPR	45°
APMX	4.5 mm

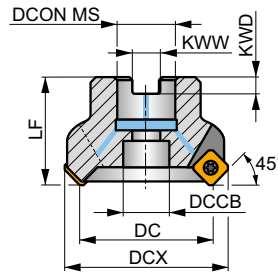
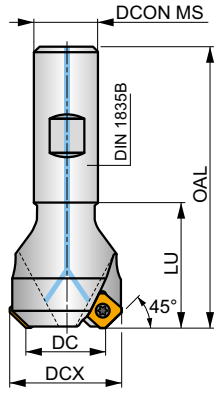
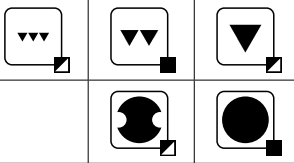
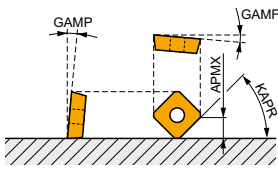

DC 32 – 125 mm

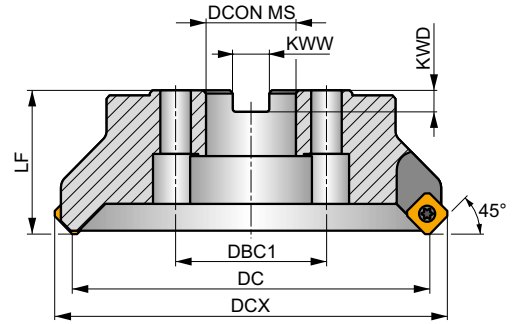

DC 160 mm

h_m 0.06 - 0.2



h_m 0.06 - 0.18

Product	DC	DCX	OAL	DCON MS	DCCB	DBC1	LU	LF	KWW	KWD	GAMF	GAMP	max.		kg	FA		AC		
	[mm]	[mm]	[mm]	[mm]	[mm]	[mm]	[mm]	[mm]	[mm]	[mm]	[°]	[°]								
20N2R032B20-SSE09-C	20	29.8	82	20	-	-	32	-	-	-	-5	20	2	-	24600	✓	0.26	GI147	FA010	-
25N3R042B25-SSE09-C	25	34.8	98	25	-	-	42	-	-	-	-5	20	3	-	22000	✓	0.44	GI147	FA010	-
32N4R042B32-SSE09-C	32	42	102	32	-	-	42	-	-	-	-5	20	4	-	19400	✓	0.68	GI147	FA010	-
32A04R-S45SE09F-C	32	42	-	16	14	-	-	40	8.4	6.4	-5	20	4	✓	19400	✓	0.24	GI147	FA012	-
40A04R-S45SE09F-C	40	53.2	-	16	14	-	-	40	8.4	6.4	-5	20	4	✓	17400	✓	0.30	GI147	FA012	-
50A05R-S45SE09F-C	50	59.6	-	22	18	-	-	40	10.4	6.4	-5	20	5	✓	15600	✓	0.56	GI147	FA013	-
63A05R-S45SE09F-C	63	75.8	-	22	18	-	-	40	10.4	6.4	-5	20	5	✓	13900	✓	0.57	GI147	FA013	-
63A06R-S45SE09F-C	63	75.8	-	22	18	-	-	40	10.4	6.4	-5	20	6	✓	13900	✓	0.58	GI147	FA013	-
80A06R-S45SE09F-C	80	89.6	-	27	38	-	-	50	12.4	7	-5	20	6	✓	12300	✓	1.14	GI147	FA011	AC001
80A08R-S45SE09F-C	80	89.6	-	27	38	-	-	50	12.4	7	-5	20	8	✓	12300	✓	1.13	GI147	FA011	AC001
100A08R-S45SE09F-C	100	110	-	32	45	-	-	50	14.4	8	-5	20	8	✓	11000	✓	1.83	GI147	FA011	AC002
100A10R-S45SE09F-C	100	110	-	32	45	-	-	50	14.4	8	-5	20	10	✓	10900	✓	1.82	GI147	FA011	AC002
125A09R-S45SE09F-C	125	134.5	-	40	60	-	-	63	16.4	9	-5	20	9	✓	9800	✓	3.87	GI147	FA011	AC003
125A12R-S45SE09F-C	125	134.5	-	40	60	-	-	63	16.4	9	-5	20	12	✓	9800	✓	3.87	GI147	FA011	AC003
160C10R-S45SE09F	160	169.6	-	40	-	66.7	-	63	16.4	9	-5	20	10	✓	8700	-	6.21	GI147	FA014	-
160C14R-S45SE09F	160	169.6	-	40	-	66.7	-	63	16.4	9	-5	20	14	✓	8700	-	6.29	GI147	FA014	-



GI147



SEET 09T3AF.



SEMT 09T3AF.



FA010	US 3007-T09P	2.0	M3	7.3	-	-	Flag T09P	-
FA011	US 3007-T09P	2.0	M3	7.3	D-T07P/T09P	FG-15	-	-
FA012	US 3007-T09P	2.0	M3	7.3	D-T07P/T09P	FG-15	-	HS 0830C



FA013	US 3007-T09P	2.0	M 3	7.3	D-T07P/T09P	FG-15	–	HS 1030C
FA014	US 3007-T09P	2.0	M 3	7.3	D-T07P/T09P	FG-15	–	HS 1240C

AC001	KS 1230	K.FMH27
AC002	KS 1635	K.FMH32
AC003	KS 2040	K.FMH40

SEET 09



	IC	D1	M	S
	[mm]	[mm]	[mm]	[mm]
09T3	9.525	3.50	1	3.97

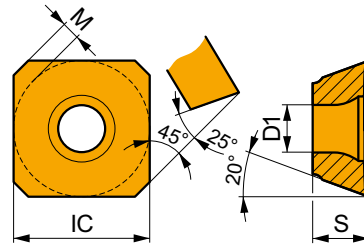

Suitability and starting values for cutting speed (vc), feed (f) and depth of cut (ap). Refer to our Machining Calculator app for further calculations.

Product	RE	P			M			K			N			S			H		
		vc	f	ap	vc	f	ap	vc	f	ap	vc	f	ap	vc	f	ap	vc	f	ap
	[mm]	[m/min]	[mm/tooth]	[mm]	[m/min]	[mm/tooth]	[mm]	[m/min]	[mm/tooth]	[mm]	[m/min]	[mm/tooth]	[mm]	[m/min]	[mm/tooth]	[mm]	[m/min]	[mm/tooth]	[mm]

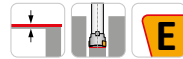
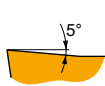

Positive design for light to medium machining.

SEET 09T3AFEN	Material	RE	vc	f	ap	vc	f	ap	vc	f	ap	vc	f	ap	vc	f	ap	vc	f	ap
8215	–	■	300	0.14	2.5	✓	180	0.13	2.5	–	–	–	–	–	–	–	–	–	–	–
M6330	–	■	255	0.14	2.5	✓	180	0.13	2.5	–	–	–	–	–	–	–	–	–	–	–
M8330	–	■	295	0.14	2.5	✓	175	0.13	2.5	–	–	–	–	–	–	–	–	–	–	–
M8340	–	■	270	0.14	2.5	✓	160	0.13	2.5	–	–	–	–	–	–	–	–	–	–	–
M9325	–	■	380	0.14	2.5	–	–	–	–	–	–	–	–	–	–	–	–	–	–	–
M9340	–	■	345	0.14	2.5	✓	205	0.13	2.5	–	–	–	–	–	–	–	–	–	–	–



SEMT 09

	IC	D1	M	S
	[mm]	[mm]	[mm]	[mm]
09T3	9.525	3.50	1	3.97

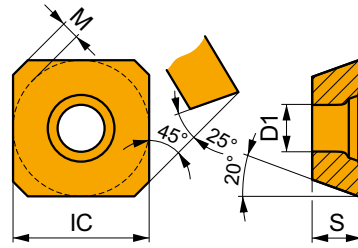

Suitability and starting values for cutting speed (vc), feed (f) and depth of cut (ap). Refer to our Machining Calculator app for further calculations.

Product	RE [mm]	P			M			K			N			S			H		
		vc [m/min]	f [mm/tooth]	ap [mm]	vc [m/min]	f [mm/tooth]	ap [mm]	vc [m/min]	f [mm/tooth]	ap [mm]	vc [m/min]	f [mm/tooth]	ap [mm]	vc [m/min]	f [mm/tooth]	ap [mm]	vc [m/min]	f [mm/tooth]	ap [mm]

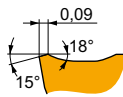

Positive design for light to medium machining.

SEMT 09T3AFSN	8215	–	■	295	0.18	1.8	☑	175	0.16	1.8	■	280	0.18	1.8	–	–	–	–	–	–
	M8330	–	■	290	0.18	1.8	☑	170	0.16	1.8	■	275	0.18	1.8	–	–	–	–	–	–
	M8340	–	■	265	0.18	1.8	☑	155	0.16	1.8	☑	250	0.18	1.8	–	–	–	–	–	–
	M9325	–	■	365	0.18	1.8	–	–	–	–	■	345	0.18	1.8	–	–	–	–	–	–



a_e / DC	5 %	10 %	15 %	20 %	25 %	30 %	40 %	50 %	60 %	70 %	75 %	80 %	90 %	100 %
	1.48	1.35	1.27	1.22	1.19	1.16	1.11	1.08	1.05	1.03	1.00	1.00	1.00	1.00
	2.20	1.60	1.35	1.20	1.10	0.95	0.85	0.75	0.85	0.95	1.00	1.00	1.00	1.00
	0.64	0.64	0.64	0.64	0.64	0.65	0.65	0.67	0.68	0.71	0.72	0.74	0.79	1.00

	SEET 09	SEMT 09
	-	-
	1.28	1.25

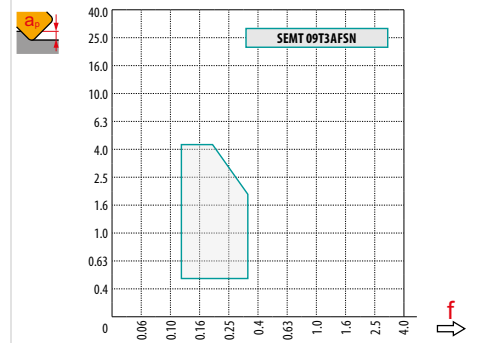
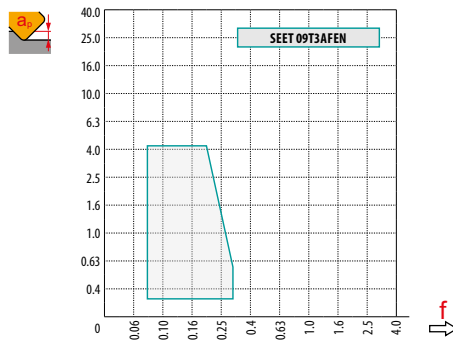

DC	X.V	f_{max}
20	1.20	0.18
25	1.24	0.20
32	1.29	0.23
40	1.33	0.25
50	1.37	0.28
63	1.41	0.32
80	1.46	0.36
100	1.50	0.40
125	1.55	0.45
160	1.60	0.51



SSN12Z



PRAMET

S



45° Face Mill with Positive Design and Internal Coolant

Highly productive 45° face mill utilising single sided SN.. 12 style inserts with APMX of 6.5 mm. Suited for face milling and chamfering. Arbor style only in range from Ø50 up to Ø250 mm. Body treated for longer tool life.

KAPR	45°
APMX	6.5 mm

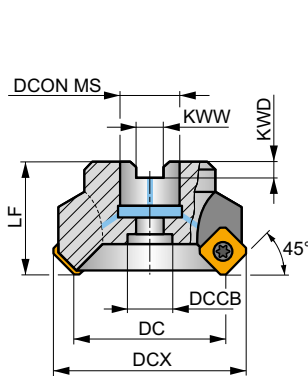
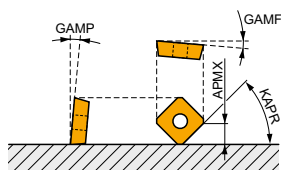

DC 40 – 125 mm

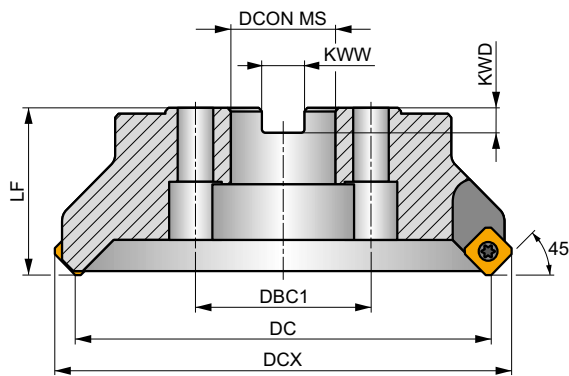

DC 160 – 250 mm

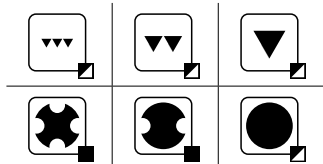

h_m 0.12 - 0.35



Product	DC	DCX	LF	DCON MS	DCCB	DBC1	KWW	KWD	GAMF	GAMP	Icons	kg	Material	Coating	Other	
	[mm]	[mm]	[mm]	[mm]	[mm]	[mm]	[mm]	[mm]	[°]	[°]						
50A04R-S45SN12Z-C	50	65	40	22	18	-	10.4	6.3	-5.5	7.5	4	-	9700	✓	0.48	GI156 FA071 -
63A05R-S45SN12Z-C	63	78	40	22	18	-	10.4	6.3	-5.5	7.5	5	-	8600	✓	0.68	GI156 FA071 -
80A06R-S45SN12Z-C	80	95	50	27	38	-	12.4	7	-5.5	7.5	6	-	7700	✓	1.42	GI156 FA071 AC001
100A07R-S45SN12Z-C	100	115	50	32	45	-	14.4	8	-5.5	7.5	7	-	6900	✓	1.70	GI156 FA071 AC002
125A08R-S45SN12Z-C	125	140	63	40	56	-	16.4	9	-5.5	7.5	8	-	6100	✓	3.59	GI156 FA071 AC003
160C10R-S45SN12Z	160	173	-	40	-	66.7	16.4	9	-5.5	7.5	10	-	5400	-	6.30	GI156 FA071 -
200C12R-S45SN12Z	200	210	-	60	-	101.6	25.7	14	-5.5	7.5	12	-	4900	-	9.10	GI156 FA071 -
250C16R-S45SN12Z	250	260	-	60	-	101.6	25.7	14	-5.5	7.5	16	-	4300	-	11.87	GI156 FA071 -

GI156	SNKT 1205AZ..	SNMT 1205AZ..
-------	---------------	---------------

FA071	US 4511-T20	5.0	M 4.5	11	SDRT20-T
-------	-------------	-----	-------	----	----------

AC001	KS 1230	K.FMH27
AC002	KS 1635	K.FMH32
AC003	KS 2040	K.FMH40



SNMT 12



	IC	D1	S
	[mm]	[mm]	[mm]
1205	12.700	5.20	5.56

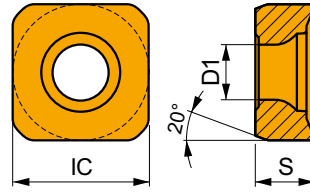

Suitability and starting values for cutting speed (vc), feed (f) and depth of cut (ap). Refer to our Machining Calculator app for further calculations.

Product	RE	P			M			K			N			S			H		
		vc	f	ap	vc	f	ap	vc	f	ap	vc	f	ap	vc	f	ap	vc	f	ap
	[mm]	[m/min]	[mm/tooth]	[mm]	[m/min]	[mm/tooth]	[mm]	[m/min]	[mm/tooth]	[mm]	[m/min]	[mm/tooth]	[mm]	[m/min]	[mm/tooth]	[mm]	[m/min]	[mm/tooth]	[mm]

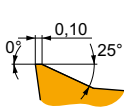

M geometry with highly positive design for medium machining.

SNMT 1205AZSR-M	8215	–	■	300	0.25	3.2	☑	180	0.23	3.2	☑	285	0.25	3.2	–	–	–	☑	75	0.18	2.6	–	–	–
	M8330	–	■	300	0.25	3.2	■	180	0.23	3.2	☑	285	0.25	3.2	–	–	–	☑	75	0.18	2.6	–	–	–
	M8340	–	■	275	0.25	3.2	■	165	0.23	3.2	☑	260	0.25	3.2	–	–	–	☑	65	0.18	2.6	–	–	–
	M9315	–	■	385	0.25	3.2	–	–	–	–	–	–	–	–	–	–	–	–	–	–	–	–	–	–
	M9325	–	■	365	0.25	3.2	–	–	–	–	–	–	–	–	–	–	–	–	–	–	–	–	–	–

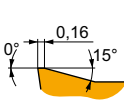

R geometry with positive design for medium to heavy machining.

SNMT 1205AZSR-R	8215	–	■	290	0.27	3.5	☑	170	0.24	3.5	☑	275	0.27	3.5	–	–	–	☑	70	0.22	2.8	–	–	–
	M5315	–	☑	365	0.27	3.5	–	–	–	–	–	–	–	–	–	–	–	–	–	–	–	–	–	
	M8330	–	■	290	0.27	3.5	☑	170	0.24	3.5	☑	275	0.27	3.5	–	–	–	☑	70	0.22	2.8	–	–	–
	M8340	–	■	270	0.27	3.5	☑	160	0.24	3.5	☑	255	0.27	3.5	–	–	–	☑	65	0.22	2.8	–	–	–
	M9315	–	■	375	0.27	3.5	–	–	–	–	–	–	–	–	–	–	–	–	–	–	–	–	–	–
	M9325	–	■	355	0.27	3.5	–	–	–	–	–	–	–	–	–	–	–	–	–	–	–	–	–	–



SNKT 12

	IC	D1	S
	[mm]	[mm]	[mm]
1205	12.700	5.20	5.56

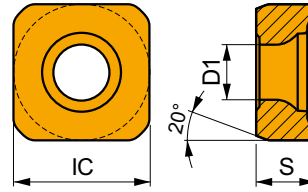

Suitability and starting values for cutting speed (vc), feed (f) and depth of cut (ap). Refer to our Machining Calculator app for further calculations.

Product	RE [mm]	P			M			K			N			S			H		
		vc [m/min]	f [mm/tooth]	ap [mm]	vc [m/min]	f [mm/tooth]	ap [mm]	vc [m/min]	f [mm/tooth]	ap [mm]	vc [m/min]	f [mm/tooth]	ap [mm]	vc [m/min]	f [mm/tooth]	ap [mm]	vc [m/min]	f [mm/tooth]	ap [mm]

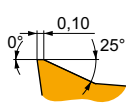

M geometry with highly positive design for medium machining.

SNKT 1205AZSR-M	M8330	-	■	305	0.24	3.2	■	180	0.22	3.2	▣	285	0.24	3.2	-	-	-	▣	75	0.17	2.6	-	-	-
	M8340	-	■	275	0.24	3.2	■	165	0.22	3.2	▣	260	0.24	3.2	-	-	-	▣	65	0.17	2.6	-	-	-



a_e / DC	5 %	10 %	15 %	20 %	25 %	30 %	40 %	50 %	60 %	70 %	75 %	80 %	90 %	100 %
	1.48	1.35	1.27	1.22	1.19	1.16	1.11	1.08	1.05	1.03	1.00	1.00	1.00	1.00
	2.20	1.60	1.35	1.20	1.10	0.95	0.85	0.75	0.85	0.95	1.00	1.00	1.00	1.00
	0.64	0.64	0.64	0.64	0.64	0.65	0.65	0.67	0.68	0.71	0.72	0.74	0.79	1.00

	SNMT 12-M	SNMT 12-R	SNKT 12-M
	-	-	-
	0.95	1.03	1.59

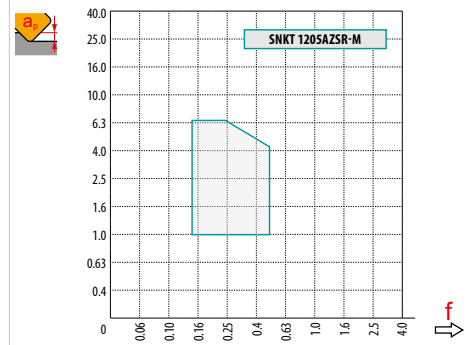
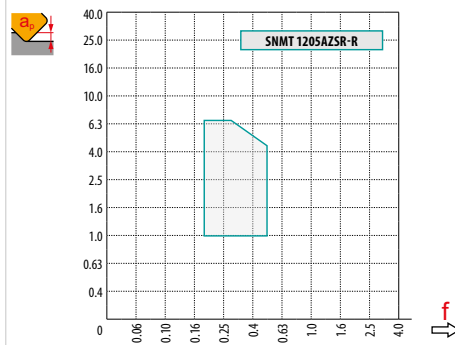
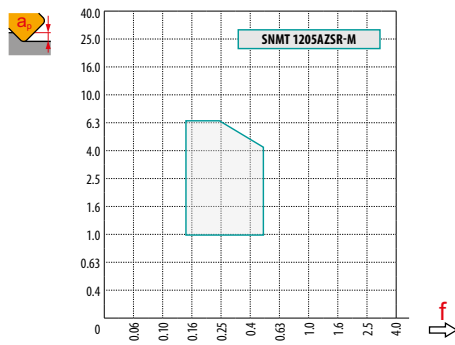

DC	X.V	f_{max}
50	1.30	0.47
63	1.34	0.53
80	1.39	0.60
100	1.43	0.67
125	1.47	0.74
160	1.53	0.84
200	1.57	0.94
250	1.62	1.05



SPN13

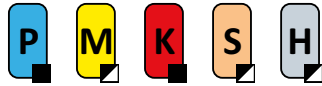

PRAMET



PENTA HD 57° Face Mill with Double Negative Design for Heavy Face Milling

Highly productive 57° face mill utilising double sided PN.. 13 and XN.. 13 style inserts with APMX of 10 mm. Suited for face milling. Arbor style only in range from Ø100 up to Ø315 mm. An insert seat protected with a shim. Body treated for longer tool life.

PENTA HD

KAPR	57°
APMX	10.0 mm

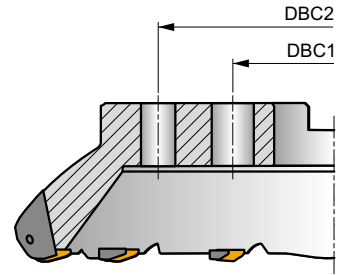
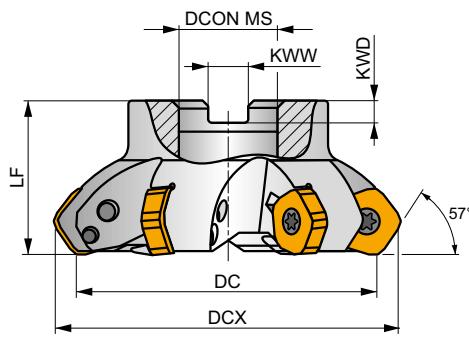
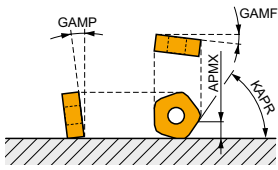

DC 160 – 315 mm

DC 100 – 125 mm

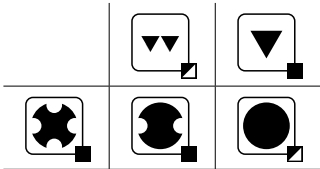

h_m 0.20 - 0.50



Product	DC	DCX	LF	DCON MS	DBC1	DBC2	KWW	KWD	GAMF	GAMP	Icons	kg	AC					
	[mm]	[mm]	[mm]	[mm]	[mm]	[mm]	[mm]	[mm]	[°]	[°]								
100A05R-S57PN13	100	115.8	50	32	-	-	14.4	8	-8.2	-4	5	-	3400	-	1.22	GI261	FA081	AC002
125A06R-S57PN13	125	140.8	63	40	-	-	16.4	9	-7	-4	6	-	3100	-	2.34	GI261	FA081	AC003
160C08R-S57PN13	160	175.8	63	40	66.7	-	16.4	9	-6	-4	8	-	2700	-	3.58	GI261	FA081	-
200C10R-S57PN13	200	215.8	63	60	101.6	-	25.7	14	-5	-4	10	-	2400	-	9.17	GI261	FA081	-
250C12R-S57PN13	250	265.8	63	60	101.6	-	25.7	14	-5	-4	12	-	2200	-	15.39	GI261	FA081	-
315C14R-S57PN13	315	330.8	80	60	101.6	177.8	25.7	14	-5	-4	14	-	1900	-	29.17	GI261	FA081	-

GI261	PNMU 1308DN..	XNGX 1308DNSN	PNMQ 1308DN..
-------	---------------	---------------	---------------

FA081	SPN 13T3DN	US 64010-T15P	SDRT15P	US 68026-T30P	15.0	M 8	26	SDRT30P-T
-------	------------	---------------	---------	---------------	------	-----	----	-----------

AC002	KS 1635	K.FMH32
AC003	KS 2040	K.FMH40



PNMU 13



	BS	IC	D1	L	S
	[mm]	[mm]	[mm]	[mm]	[mm]
1308	3.00	24.400	10.00	13.00	7.94

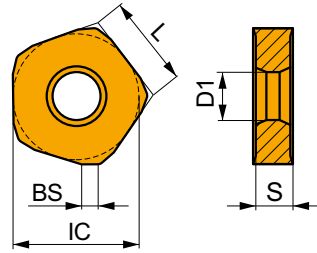

Suitability and starting values for cutting speed (vc), feed (f) and depth of cut (ap). Refer to our Machining Calculator app for further calculations.

Product	RE	P			M			K			N			S			H		
		vc	f	ap	vc	f	ap	vc	f	ap	vc	f	ap	vc	f	ap	vc	f	ap
	[mm]	[m/min]	[mm/tooth]	[mm]	[m/min]	[mm/tooth]	[mm]	[m/min]	[mm/tooth]	[mm]	[m/min]	[mm/tooth]	[mm]	[m/min]	[mm/tooth]	[mm]	[m/min]	[mm/tooth]	[mm]

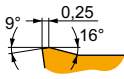

M geometry with positive design for rough machining.

PNMU 1308DNSR-M	8215	–	█	165	0.35	6.5	▣	95	0.32	6.5	█	155	0.35	6.5	–	–	–	▣	40	0.28	5.2	▣	30	0.15	1.0
	M8330	–	█	190	0.35	6.5	▣	110	0.32	6.5	█	180	0.35	6.5	–	–	–	▣	45	0.28	5.2	▣	35	0.15	1.0
	M8345	–	█	135	0.35	6.5	▣	80	0.32	6.5	–	–	–	–	–	–	▣	30	0.28	5.2	–	–	–	–	
	M9315	–	█	210	0.35	6.5	–	–	–	–	–	–	–	–	–	–	–	▣	–	–	–	▣	40	0.15	1.0
	M9340	–	█	170	0.35	6.5	▣	100	0.32	6.5	–	–	–	–	–	–	–	▣	40	0.28	5.2	–	–	–	–

PNMQ 13



	BS	IC	D1	L	S
	[mm]	[mm]	[mm]	[mm]	[mm]
1308	3.00	24.400	10.00	13.00	7.94

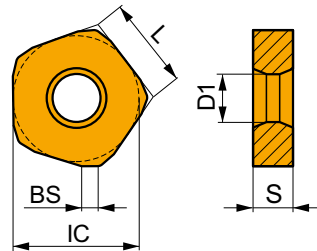

Suitability and starting values for cutting speed (vc), feed (f) and depth of cut (ap). Refer to our Machining Calculator app for further calculations.

Product	RE	P			M			K			N			S			H		
		vc	f	ap	vc	f	ap	vc	f	ap	vc	f	ap	vc	f	ap	vc	f	ap
	[mm]	[m/min]	[mm/tooth]	[mm]	[m/min]	[mm/tooth]	[mm]	[m/min]	[mm/tooth]	[mm]	[m/min]	[mm/tooth]	[mm]	[m/min]	[mm/tooth]	[mm]	[m/min]	[mm/tooth]	[mm]

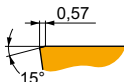

Zero rake angle design particularly suited to rough machining.

PNMQ 1308DNSN	M8330	–	▣	165	0.60	6.5	–	–	–	█	155	0.60	6.5	–	–	–	–	–	–	–	–	▣	30	0.15	1.0
	M8345	–	▣	120	0.60	6.5	–	–	–	–	–	–	–	–	–	–	–	–	–	–	–	–	–	–	–



XNGX 13

	IC	D1	S
	[mm]	[mm]	[mm]
1308	24.180	10.00	7.94

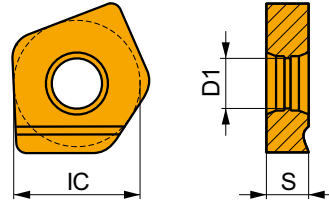

Suitability and starting values for cutting speed (vc), feed (f) and depth of cut (ap). Refer to our Machining Calculator app for further calculations.

Product	RE [mm]	P			M			K			N			S			H		
		vc [m/min]	f [mm/tooth]	ap [mm]	vc [m/min]	f [mm/tooth]	ap [mm]	vc [m/min]	f [mm/tooth]	ap [mm]	vc [m/min]	f [mm/tooth]	ap [mm]	vc [m/min]	f [mm/tooth]	ap [mm]	vc [m/min]	f [mm/tooth]	ap [mm]



Wiper design for improved surface finish.

XNGX 1308DNSN	M8330	-	■	245	0.45	2.5	-	-	-	■	230	0.45	2.5	-	-	-	-	-	-	-	-	-
----------------------	--------------	---	---	-----	------	-----	---	---	---	---	-----	------	-----	---	---	---	---	---	---	---	---	---



a_e / DC	5 %	10 %	15 %	20 %	25 %	30 %	40 %	50 %	60 %	70 %	75 %	80 %	90 %	100 %
	1.48	1.35	1.27	1.22	1.19	1.16	1.11	1.08	1.05	1.03	1.00	1.00	1.00	1.00
	2.20	1.60	1.35	1.20	1.10	0.95	0.85	0.75	0.85	0.95	1.00	1.00	1.00	1.00
	0.64	0.64	0.64	0.64	0.64	0.65	0.65	0.67	0.68	0.71	0.72	0.74	0.79	1.00

	PNMU 13-M	PNMQ 13	XNGX 13
	-	-	-
	3.00	3.00	12.71

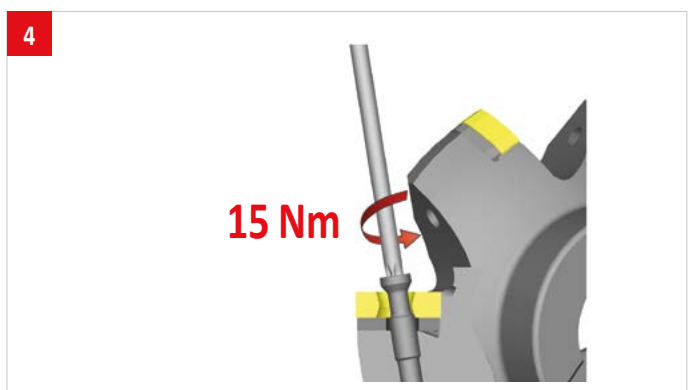
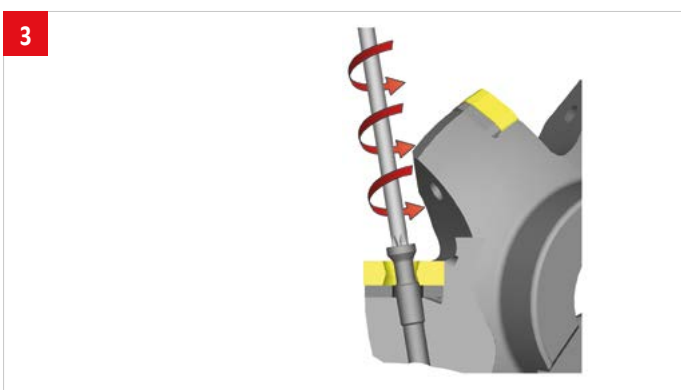
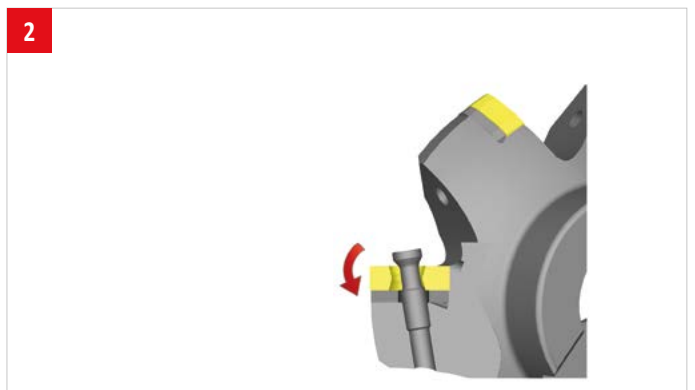
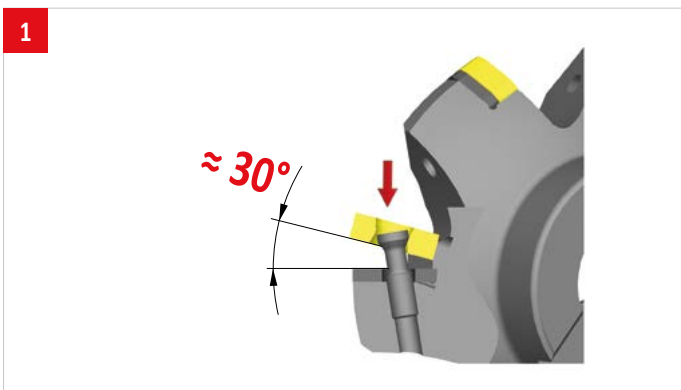
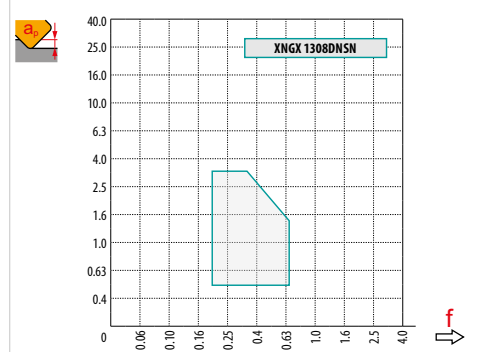
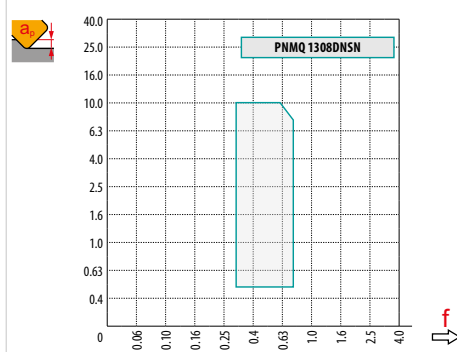
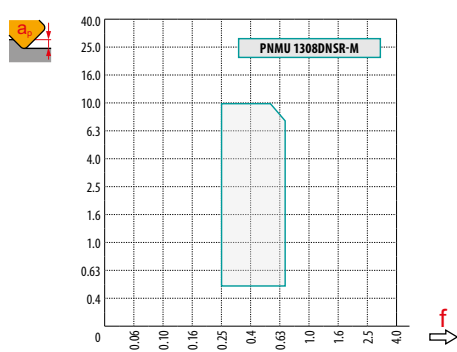



CHN09



PRAMET

C



ECON HN 60° Face mill with Double Negative Design for Cast Iron

Highly productive 60° face mill utilising double sided HN.. 09 style inserts with APMX of up to 6 mm (depending on insert type). Optimized for face milling in cast iron. Arbor style only in range from Ø80 up to Ø200 mm. Body treated for longer tool life.

KAPR	60°
APMX	6.0 mm

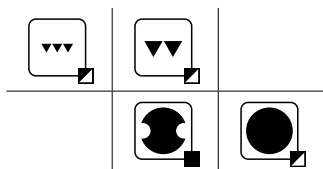
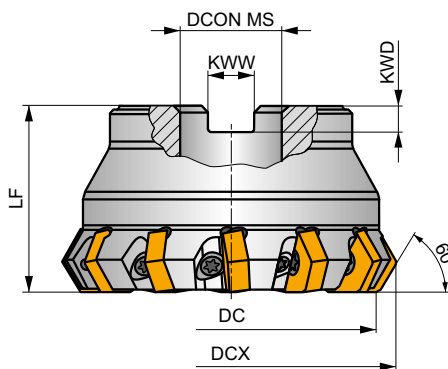
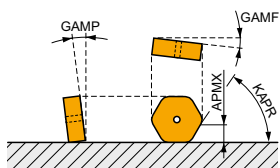

0.07 - 0.3



Product	DC	DCX	LF	DCON MS	KWW	KWD	GAMF	GAMP							
	[mm]	[mm]	[mm]	[mm]	[mm]	[mm]	[°]	[°]							
80A08R-C60HN09	80	89.4	50	27	12.4	7	-5	-7.2	8	-	6200	-	1.45	GI262	FA094
80A12R-C60HN09	80	89.4	50	27	12.4	7	-5	-7.2	12	-	6200	-	1.39	GI262	FA094
100A10R-C60HN09	100	109.4	50	32	14.4	8	-5	-7.2	10	-	5600	-	2.44	GI262	FA095
100A16R-C60HN09	100	109.4	50	32	14.4	8	-5	-7.2	16	-	5600	-	2.32	GI262	FA095
125A12R-C60HN09	125	134.4	63	40	16.4	9	-5	-7.2	12	-	5000	-	4.23	GI262	FA096
125A20R-C60HN09	125	134.4	63	40	16.4	9	-5	-7.2	20	-	5000	-	4.09	GI262	FA096
160C16R-C60HN09	160	169.4	63	40	-	-	-5	-7.2	16	-	4400	-	6.20	GI262	FA091
200C20R-C60HN09	200	209.4	63	60	-	-	-5	-7.2	20	-	3900	-	11.08	GI262	FA091



GI262



HNEF 0905..



HNMF 0905..

FA091	US 74016-T15P	3.5	M 4	16	D-T08P/T15P	FG-15	-
FA094	US 74016-T15P	3.5	M 4	16	D-T08P/T15P	FG-15	HS 1230C
FA095	US 74016-T15P	3.5	M 4	16	D-T08P/T15P	FG-15	HS 1635C
FA096	US 74016-T15P	3.5	M 4	16	D-T08P/T15P	FG-15	HS 2040C



HNEF 09



	IC	L	S
	[mm]	[mm]	[mm]
0905	16.200	9.40	5.64

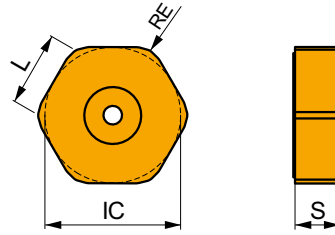

Suitability and starting values for cutting speed (vc), feed (f) and depth of cut (ap). Refer to our Machining Calculator app for further calculations.

Product	RE	P			M			K			N			S			H			
		vc	f	ap	vc	f	ap	vc	f	ap	vc	f	ap	vc	f	ap	vc	f	ap	
	[mm]	[m/min]	[mm/tooth]	[mm]	[m/min]	[mm/tooth]	[mm]	[m/min]	[mm/tooth]	[mm]	[m/min]	[mm/tooth]	[mm]	[m/min]	[mm/tooth]	[mm]	[m/min]	[mm/tooth]	[mm]	
 F geometry with positive design for light machining.																				
HNEF 0905DNFN-F	M5315	0.4	-	-	-	-	-	380	0.15	1.5	-	-	-	-	-	-	-	-	-	-
 M geometry with positive design for light to medium machining.																				
HNEF 090508EN-M	M5315	0.8	-	-	-	-	-	290	0.18	3.0	-	-	-	-	-	-	-	-	-	-
	M9325	0.8	-	-	-	-	-	275	0.18	3.0	-	-	-	-	-	-	-	-	-	-
 W geometry positive design for finishing.																				
HNEF 0905ZZR-W	8215	0.8	-	-	-	-	-	275	0.18	1.0	-	-	-	-	-	-	-	-	-	-
	M5315	0.8	-	-	-	-	-	370	0.18	1.0	-	-	-	-	-	-	-	-	-	-



HNMF 09

	IC [mm]	L [mm]	S [mm]
0905	16.200	9.40	5.64

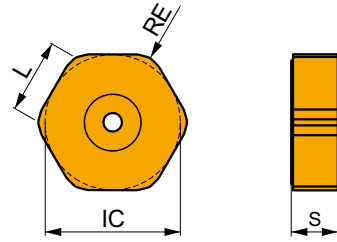

Suitability and starting values for cutting speed (vc), feed (f) and depth of cut (ap). Refer to our Machining Calculator app for further calculations.

Product	RE [mm]	P			M			K			N			S			H		
		vc [m/min]	f [mm/tooth]	ap [mm]	vc [m/min]	f [mm/tooth]	ap [mm]	vc [m/min]	f [mm/tooth]	ap [mm]	vc [m/min]	f [mm/tooth]	ap [mm]	vc [m/min]	f [mm/tooth]	ap [mm]			

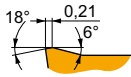

R geometry with negative design for light and heavy machining.

HNMF 090516SN-R	8215	1.6	-	-	-	-	-	-	-	-	-	-	-	-	-	-	-	-
	M5315	1.6	-	-	-	-	-	-	-	-	-	-	-	-	-	-	-	-
	M9325	1.6	-	-	-	-	-	-	-	-	-	-	-	-	-	-	-	-



a_e / DC	5 %	10 %	15 %	20 %	25 %	30 %	40 %	50 %	60 %	70 %	75 %	80 %	90 %	100 %
	1.48	1.35	1.27	1.22	1.19	1.16	1.11	1.08	1.05	1.03	1.00	1.00	1.00	1.00
	2.20	1.60	1.35	1.20	1.10	0.95	0.85	0.75	0.85	0.95	1.00	1.00	1.00	1.00
	0.64	0.64	0.64	0.64	0.64	0.65	0.65	0.67	0.68	0.71	0.72	0.74	0.79	1.00

	HNEF 09-F	HNEF 09-M	HNEF 09-R	HNEF 09-ZZL-W	HNEF 09-ZZR-W
	-	-	-	-	-
	1.20	-	-	1.26	1.26

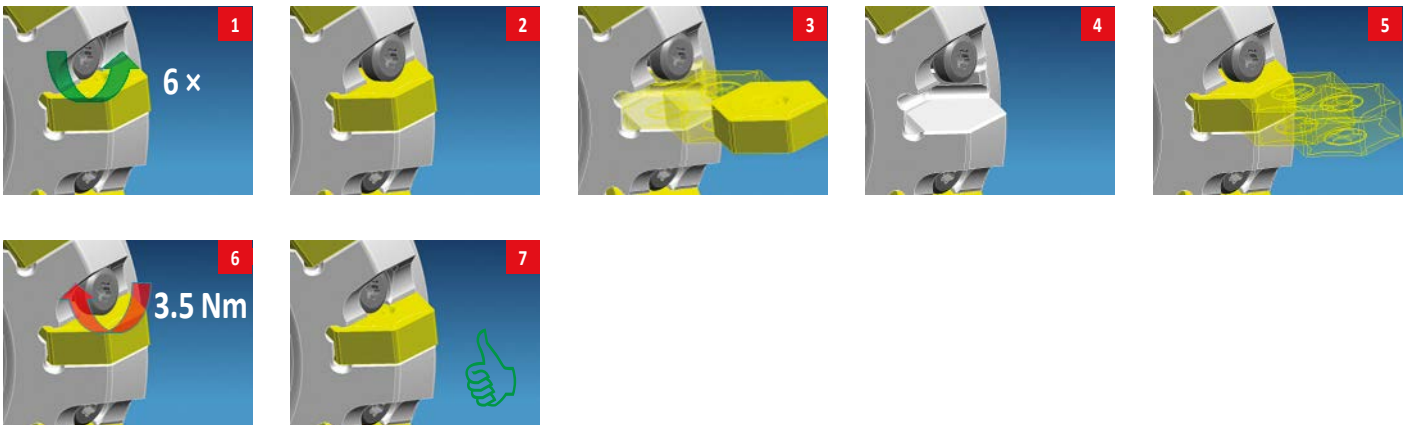
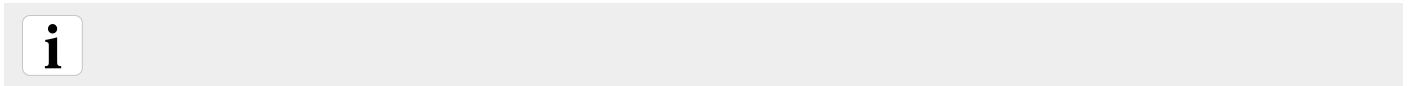
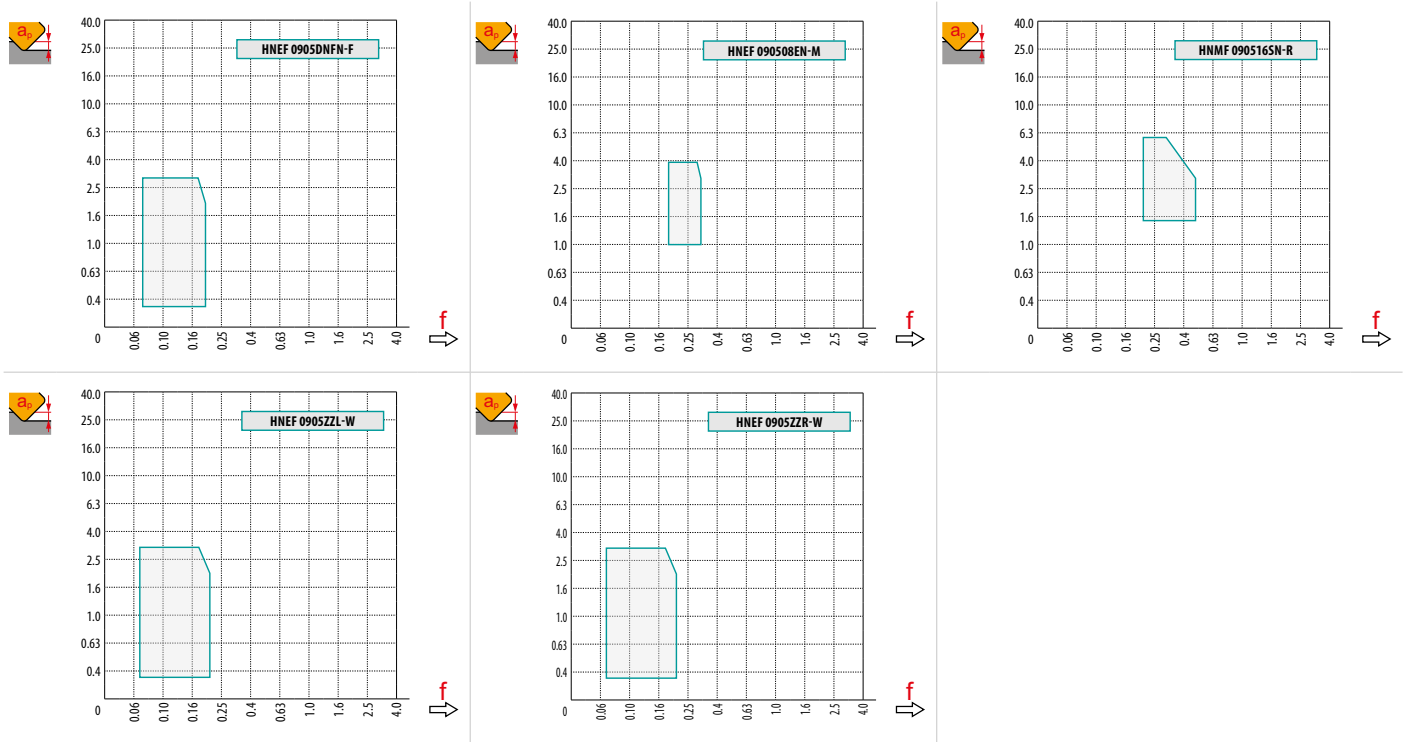



FSB22X

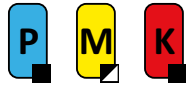

PRAMET



ROUGH SB 60° Face Mill with Positive Design for Heavy Face Milling

Highly productive 60° face mill utilising single sided SB.. 22 style inserts with APMX of 15 mm. Optimized for heavy face milling with smooth cutting action. Differential tooth pitch. Arbor style only in range from Ø125 up to Ø315 mm. Body treated for longer tool life.

ROUGH SB

KAPR	60°
APMX	15.0 mm

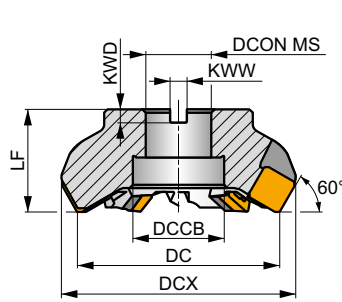
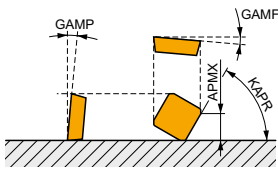

DC 125 mm

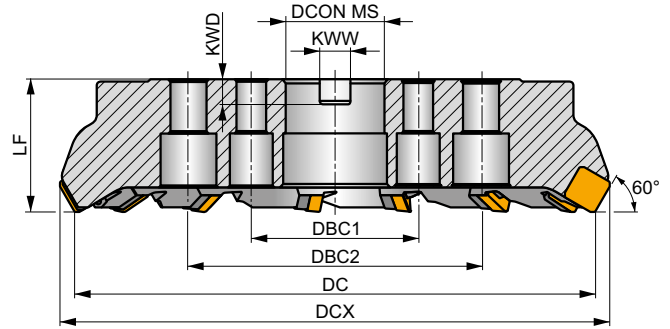

DC 160 – 315 mm

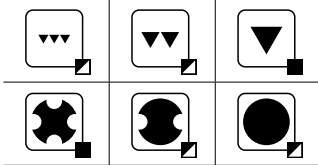

h_m 0.15 - 0.5



Product	DC	DCX	LF	DCON MS	DCCB	DBC1	DBC2	KWW	KWD	GAMF	GAMP	Icons: Max, kg, etc.			G144	FA111	AC003		
	[mm]	[mm]	[mm]	[mm]	[mm]	[mm]	[mm]	[mm]	[mm]	[°]	[°]								
125B05R-F60SB22X	125	144.4	63	40	56	-	-	16.4	9	-9	9	5	✓	-	-	3.88	GI144	FA111	AC003
125B07R-F60SB22X	125	144.4	63	40	56	-	-	16.4	9	-9	9	7	✓	-	-	3.64	GI144	FA111	AC003
160C06R-F60SB22X	160	178.7	63	40	-	66.7	-	16.4	9	-9	9	6	✓	-	-	6.51	GI144	FA114	-
160C08R-F60SB22X	160	178.7	63	40	-	66.7	-	16.4	9	-9	9	8	✓	-	-	6.30	GI144	FA114	-
200C08R-F60SB22X	200	217.9	63	60	-	101.6	-	25.7	14	-9	9	8	✓	-	-	10.59	GI144	FA115	-
200C10R-F60SB22X	200	217.9	63	60	-	101.6	-	25.7	14	-9	9	10	✓	-	-	9.81	GI144	FA115	-
250C09R-F60SB22X	250	267.4	63	60	-	101.6	-	25.7	14	-9	9	9	✓	-	-	17.54	GI144	FA115	-
250C12R-F60SB22X	250	267.4	63	60	-	101.6	-	25.7	14	-9	9	12	✓	-	-	16.50	GI144	FA115	-
315C11R-F60SB22X	315	331.8	80	60	-	101.6	177.8	25.7	14	-9	9	11	✓	-	-	36.00	GI144	FA115	-
315C14R-F60SB22X	315	331.8	80	60	-	101.6	177.8	25.7	14	-9	9	14	✓	-	-	36.50	GI144	FA115	-

GI144	SBKX 2207DZ..	SBMR 2207DZ..
-------	---------------	---------------

FA111	LNx 220616	US 6013-T20P	SDRT20P-T	KU SBMR 2207	DS 01Z	KL 04	-
FA114	LNx 220616	US 6013-T20P	SDRT20P-T	KU SBMR 2207	DS 01Z	KL 04	HS 1240
FA115	LNx 220616	US 6013-T20P	SDRT20P-T	KU SBMR 2207	DS 01Z	KL 04	HS 1655

AC003	KS 2040	K.FMH40
-------	---------	---------



SBMR 22

PRAMET

	IC	M	S	BS
	[mm]	[mm]	[mm]	[mm]
2207	22.000	3	8.00	1.99

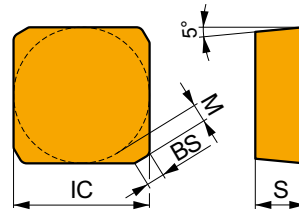

Suitability and starting values for cutting speed (vc), feed (f) and depth of cut (ap). Refer to our Machining Calculator app for further calculations.

Product	RE	P			M			K			N			S			H		
		vc	f	ap	vc	f	ap	vc	f	ap	vc	f	ap	vc	f	ap	vc	f	ap
	[mm]	[m/min]	[mm/tooth]	[mm]	[m/min]	[mm/tooth]	[mm]	[m/min]	[mm/tooth]	[mm]	[m/min]	[mm/tooth]	[mm]	[m/min]	[mm/tooth]	[mm]	[m/min]	[mm/tooth]	[mm]

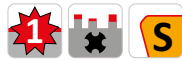
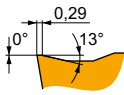

Stable design for heavy machining.

SBMR 2207DZSR	M8326	-	140	0.38	8.5	-	-	-	130	0.38	8.5	-	-	-	-	-	-	-	-
	M8346	-	120	0.38	8.5	70	0.38	8.5	-	-	-	-	-	-	-	-	-	-	-
	M9325	-	175	0.38	8.5	-	-	-	165	0.38	8.5	-	-	-	-	-	-	-	-

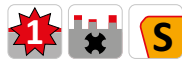
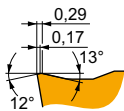

R geometry with stable design for heavy machining.

SBMR 2207DZSR-R	M5326	-	160	0.44	9.8	-	-	-	150	0.44	9.8	-	-	-	-	-	-	-	-
	M8326	-	135	0.44	9.8	-	-	-	125	0.44	9.8	-	-	-	-	-	-	-	-
	M8346	-	115	0.44	9.8	65	0.40	9.8	-	-	-	-	-	-	-	-	-	-	-

SBKX 22

PRAMET

	IC	M	S	BS
	[mm]	[mm]	[mm]	[mm]
2207	22.000	3	8.00	11.84

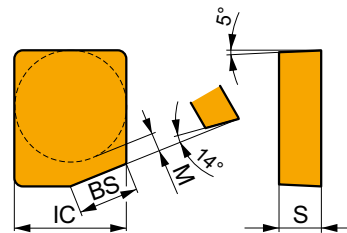

Suitability and starting values for cutting speed (vc), feed (f) and depth of cut (ap). Refer to our Machining Calculator app for further calculations.

Product	RE	P			M			K			N			S			H		
		vc	f	ap	vc	f	ap	vc	f	ap	vc	f	ap	vc	f	ap	vc	f	ap
	[mm]	[m/min]	[mm/tooth]	[mm]	[m/min]	[mm/tooth]	[mm]	[m/min]	[mm/tooth]	[mm]	[m/min]	[mm/tooth]	[mm]	[m/min]	[mm/tooth]	[mm]	[m/min]	[mm/tooth]	[mm]



Zero rake wiper design for improved surface finish.

SBKX 2207DZER	M8326	-	100	0.60	8.5	-	-	-	95	0.60	8.5	-	-	-	-	-	-	-	-
---------------	-------	---	-----	------	-----	---	---	---	----	------	-----	---	---	---	---	---	---	---	---



a_e / DC	5 %	10 %	15 %	20 %	25 %	30 %	40 %	50 %	60 %	70 %	75 %	80 %	90 %	100 %
	1.48	1.35	1.27	1.22	1.19	1.16	1.11	1.08	1.05	1.03	1.00	1.00	1.00	1.00
	2.20	1.60	1.35	1.20	1.10	0.95	0.85	0.75	0.85	0.95	1.00	1.00	1.00	1.00
	0.64	0.64	0.64	0.64	0.64	0.65	0.65	0.67	0.68	0.71	0.72	0.74	0.79	1.00

	SBMR 22	SBMR 22-R	SBKX 22
	-	-	-
	1.99	1.99	11.84

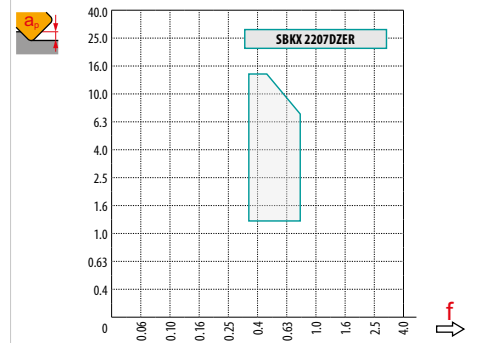
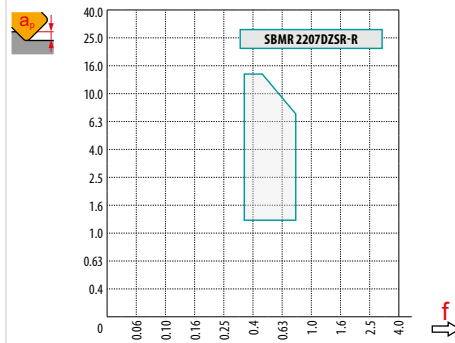
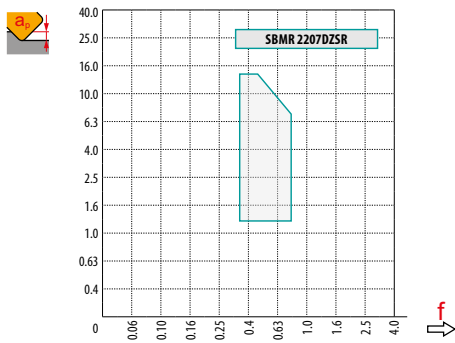



DORMER PRAMET



HELP IS AT HAND

Our technical support team are always at hand to help with any technical questions or queries you have about our technical apps. Use the contact us details to reach out to your local Dormer Pramet sales office. **Simply Reliable.**

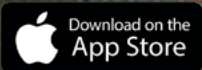
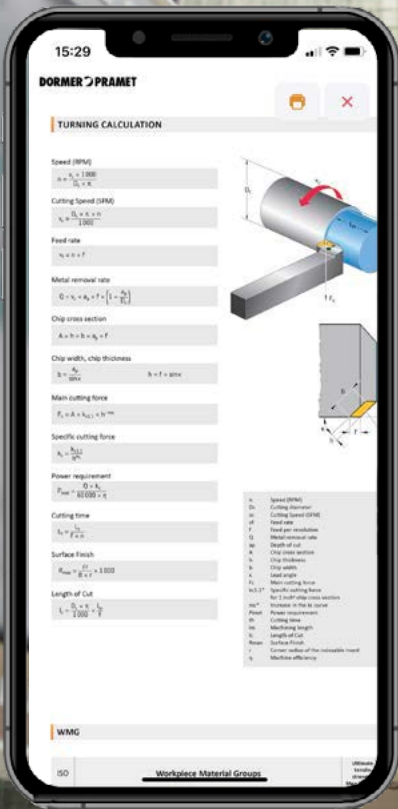





























INDEXABLE SQUARE SHOULDER MILLS



INDEXABLE SQUARE SHOULDER MILLS – NAVIGATOR

SQUARE SHOULDER MILLING



	SAD07D		SAD11E		SAD16E		SAP10D		SAP16D																		
	90°		90°		90°		90°		90°																		
	APMX [mm]	5.0	APMX [mm]	9.0	APMX [mm]	13.0	APMX [mm]	9.0	APMX [mm]	13.0																	
	DC [mm]	10 – 32	DC [mm]	16 – 125	DC [mm]	25 – 175	DC [mm]	10 – 63	DC [mm]	25 – 160																	
Cylindrical shank		DC = 10 – 25 [mm]		DC = 16 – 35 [mm]		DC = 25 – 32 [mm]																					
Weldon				DC = 16 – 32 [mm]		DC = 25 – 40 [mm]		DC = 10 – 25 [mm]		DC = 25 – 40 [mm]																	
Modular		DC = 12 – 32 [mm]		DC = 16 – 40 [mm]		DC = 32 – 40 [mm]																					
Shell mill				DC = 40 – 125 [mm]		DC = 40 – 175 [mm]		DC = 40 – 63 [mm]		DC = 40 – 160 [mm]																	
Page	413		420		429		438		441																		
ISO	P	M	K	N	S	P	M	K	N	S	H	P	M	K	N	S	H	P	M	K	N	S	P	M	K	N	S
Insert shape																											
Inserts	AD.X 0702		AD.X 11T3		AD.X 1606		APKT 1003		APT 1604																		
No. of cutting edges	2		2		2		2		2																		
Shallow shoulder milling 	■		■		■		■		■																		
Helical interpolation 	■		■		■		■		■																		
Shallow slot milling 	■		■		■		■		■																		
Plunge milling 	■		■		■		■		■																		
Progressive plunging 	■		■		■		■		■																		
Ramping 	■		■		■		■		■																		
Face milling 	▣		▣		▣		▣		▣																		
Shape surfaces milling (copy milling) 	▣		■		■																						



INDEXABLE SQUARE SHOULDER MILLS – NAVIGATOR



SQUARE SHOULDER MILLING















	STN10		STN16		SLN12		SLN16		SSO050		SSO09									
	90°		90°		90°		90°		90°		90°									
	APMX [mm]	5.0	APMX [mm]	10.0	APMX [mm]	9.0	APMX [mm]	13.0	APMX [mm]	4.5	APMX [mm]	8.0								
	DC [mm]	18 – 32	DC [mm]	25 – 175	DC [mm]	25 – 125	DC [mm]	63 – 175	DC [mm]	12 – 40	DC [mm]	20 – 125								
		DC = 18 – 32 [mm]		DC = 25 – 35 [mm]		DC = 25 – 32 [mm]				DC = 12 – 25 [mm]										
		DC = 20 – 32 [mm]		DC = 25 – 40 [mm]		DC = 25 – 40 [mm]				DC = 20 – 32 [mm]		DC = 20 – 32 [mm]								
		DC = 20 – 32 [mm]		DC = 25 – 40 [mm]		DC = 25 – 40 [mm]														
		DC = 40 – 80 [mm]		DC = 40 – 175 [mm]		DC = 40 – 125 [mm]				DC = 32 – 40 [mm]		DC = 40 – 125 [mm]								
	📖 446		📖 450		📖 455		📖 461		📖 466		📖 469									
	P	M	K	N	P	M	K	N	P	K	N	H	P	M	K	S	P	M	K	S
	TNGX 1004		TNGX 1606		LNG. 1205		LN.U 1607		SOMT 0502		SOMT 09T3									
	6		6		4		4		4		4									
	■		■		■		■		■		■									
	▣		▣		▣															
	■		■		■		■		■		■									
	▣				■		■		■		■									
	▣				▣		▣													
	■		■		▣		▣				▣									
					▣		▣		■											



INDEXABLE SQUARE SHOULDER MILLS – NAVIGATOR

<<< SQUARE SHOULDER MILLING

	SSD12		FTB27X																	
	90°		90°																	
	APMX [mm]	10.0	APMX [mm]	18.0																
	DC [mm]	50 – 160	DC [mm]	140 – 260																
Cylindrical shank																				
Weldon																				
Modular																				
Shell mill																				
Page	472		475																	
ISO	P	M	K	N	S	P	M	K												
Insert shape																				
Inserts	SDMT 1205		TBMR 2707																	
No. of cutting edges	4		3																	
Shallow shoulder milling 	■		■																	
Helical interpolation 																				
Shallow slot milling 	■		▣																	
Plunge milling 	■																			
Progressive plunging 																				
Ramping 																				
Face milling 	▣		▣																	
Shape surfaces milling (copy milling) 																				



SAD07D

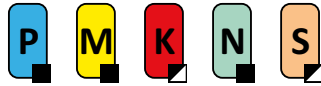

PRAMET

S



FORCE AD07 Square Shoulder Mill with Internal Coolant

90° end mill utilising positive AD.. 07 style insert with APMX of 5 mm. Suitable for applications, including face, shoulder, slot, helical, trochoidal, ramping and plunge milling. Available in cylindrical and modular style and with differential tooth pitch, in Ø10 up to Ø32 mm. Body treated for longer tool life.

FORCE AD

KAPR	90°
APMX	5.0 mm

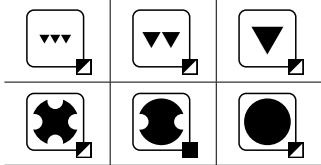
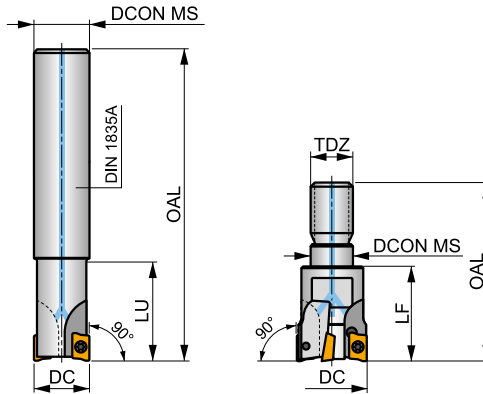
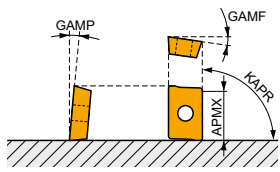

h_m 0.03 - 0.08



Product	DC	OAL	DCON MS	LU	LF	TDZ	GAMF	GAMP							
	[mm]	[mm]	[mm]	[mm]	[mm]	[mm]	[°]	[°]							
10A2R016A08-SAD07D-C	10	100	8	16	-	-	-12	8	2	-	61600	✓	0.07	GI276	SQ010
10A2R016A10-SAD07D-C	10	80	10	16	-	-	-12	8	2	-	61600	✓	0.07	GI276	SQ010
10A2R018A08-SAD07D-CF	10	100	8	18	-	-	-12	8	2	-	61600	✓	0.07	GI276	SQ010
10A2R018A10-SAD07D-CF	10	80	10	18	-	-	-12	8	2	-	61600	✓	0.07	GI276	SQ010
12A2R018A10-SAD07D-C	12	120	10	18	-	-	-10	8	2	-	56300	✓	0.09	GI276	SQ010
12A2R018A12-SAD07D-C	12	90	12	18	-	-	-10	8	2	-	56300	✓	0.10	GI276	SQ010
12A3R018A12-SAD07D-C	12	90	12	18	-	-	-10	8	3	-	56200	✓	0.10	GI276	SQ010
12A3R020A12-SAD07D-CF	12	90	12	20	-	-	-10	8	3	-	56200	✓	0.10	GI276	SQ010
14A3R018A12-SAD07D-C	14	140	12	18	-	-	-9	8	3	-	52100	✓	0.15	GI276	SQ010
14A3R018A14-SAD07D-C	14	90	14	18	-	-	-9	8	3	-	52100	✓	0.12	GI276	SQ010
14A3R020A12-SAD07D-CF	14	140	12	20	-	-	-9	8	3	-	52100	✓	0.14	GI276	SQ010
14A3R020A14-SAD07D-CF	14	90	14	20	-	-	-9	8	3	-	52100	✓	0.09	GI276	SQ010
16A3R019A14-SAD07D-C	16	160	14	19	-	-	-8	8	3	-	48700	✓	0.21	GI276	SQ011
16A3R019A16-SAD07D-C	16	110	16	19	-	-	-8	8	3	-	48700	✓	0.18	GI276	SQ011
16A4R019A16-SAD07D-C	16	110	16	19	-	-	-8	8	4	-	48700	✓	0.18	GI276	SQ011
18A4R019A16-SAD07D-C	18	180	16	19	-	-	-7.5	8	4	✓	45900	✓	0.28	GI276	SQ011
18A4R019A18-SAD07D-C	18	110	18	19	-	-	-7.5	8	4	✓	45900	✓	0.22	GI276	SQ011
20A4R020A18-SAD07D-C	20	200	18	20	-	-	-7	8	4	✓	43600	✓	0.38	GI276	SQ011
20A4R020A20-SAD07D-C	20	125	20	20	-	-	-7	8	4	✓	43600	✓	0.30	GI276	SQ011
20A5R020A20-SAD07D-C	20	125	20	20	-	-	-7	8	5	✓	43600	✓	0.30	GI276	SQ011
25A5R024A25-SAD07D-C	25	140	25	24	-	-	-6.5	8	5	✓	39000	✓	0.52	GI276	SQ011
25A6R024A25-SAD07D-C	25	140	25	24	-	-	-6.5	8	6	✓	39000	✓	0.52	GI276	SQ011
12A2R020M06-SAD07D-C	12	35	6.5	-	20	M6	-10	8	2	-	-	✓	0.05	GI276	SQ010
14A3R020M08-SAD07D-C	14	38	8.5	-	20	M8	-9	8	3	-	-	✓	0.05	GI276	SQ010
14A3R023M08-SAD07D-CF	14	41	8.5	-	23	M8	-9	8	3	-	-	✓	0.05	GI276	SQ010
16A4R023M08-SAD07D-C	16	41	8.5	-	23	M8	-8	8	4	✓	-	✓	0.06	GI276	SQ011
20A5R030M10-SAD07D-C	20	49	10.5	-	30	M10	-7	8	5	✓	-	✓	0.09	GI276	SQ011



Product	DC	OAL	DCONMS	LU	LF	TDZ	GAMF	GAMP							
	[mm]	[mm]	[mm]	[mm]	[mm]		[°]	[°]							
25A6R035M12-SAD07D-C	25	57	12.5	-	35	M12	-6.5	8	6	✓	-	✓	0.13	GI276	SQ011
32A8R043M16-SAD07D-C	32	66	17	-	43	M16	-6	8	8	✓	-	✓	0.25	GI276	SQ011

GI276	ADMX 0702..

SQ010	US 62003A-T06P	0.6	M 2	3	Flag T06P
SQ011	US 62004A-T06P	0.6	M 2	4	Flag T06P

ADMX 07



	W1	D1	L	S
	[mm]	[mm]	[mm]	[mm]
0702	4.482	2.20	6.95	2.48

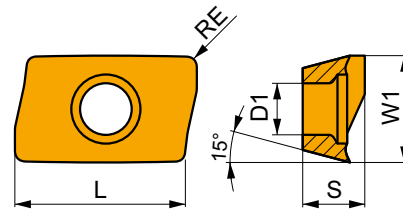

Suitability and starting values for cutting speed (vc), feed (f) and depth of cut (ap). Refer to our Machining Calculator app for further calculations.

Product	RE	P			M			K			N			S			H		
		vc	f	ap	vc	f	ap	vc	f	ap	vc	f	ap	vc	f	ap	vc	f	ap
	[mm]	[m/min]	[mm/tooth]	[mm]	[m/min]	[mm/tooth]	[mm]	[m/min]	[mm/tooth]	[mm]	[m/min]	[mm/tooth]	[mm]	[m/min]	[mm/tooth]	[mm]	[m/min]	[mm/tooth]	[mm]

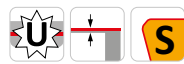
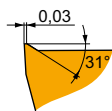

F geometry with very sharp positive design for light machining.

ADMX 070202SR-F	M8330	0.2	220	0.07	2.0	130	0.06	2.0	-	-	-	660	0.08	2.0	55	0.05	1.6	-	-	-
	M8340	0.2	200	0.07	2.0	120	0.06	2.0	-	-	-	-	-	-	50	0.05	1.6	-	-	-
ADMX 070204SR-F	M6330	0.4	200	0.07	2.0	140	0.06	2.0	-	-	-	-	-	-	60	0.05	1.6	-	-	-
	M8310	0.4	265	0.07	2.0	135	0.06	2.0	-	-	-	-	-	-	-	-	-	-	-	-
	M8330	0.4	235	0.07	2.0	140	0.06	2.0	-	-	-	705	0.08	2.0	55	0.05	1.6	-	-	-
	M8340	0.4	215	0.07	2.0	125	0.06	2.0	-	-	-	-	-	-	50	0.05	1.6	-	-	-
ADMX 070208SR-F	M9340	0.4	290	0.07	2.0	170	0.06	2.0	-	-	-	-	-	-	70	0.05	1.6	-	-	-
	M6330	0.8	240	0.07	2.0	170	0.06	2.0	-	-	-	-	-	-	70	0.05	1.6	-	-	-
	M8310	0.8	320	0.07	2.0	160	0.06	2.0	-	-	-	-	-	-	-	-	-	-	-	-
	M8330	0.8	280	0.07	2.0	165	0.06	2.0	-	-	-	840	0.08	2.0	70	0.05	1.6	-	-	-
	M8340	0.8	255	0.07	2.0	150	0.06	2.0	-	-	-	-	-	-	60	0.05	1.6	-	-	-

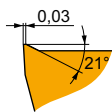

M geometry with positive design for light to medium machining.

ADMX 070202SR-M	8215	0.2	210	0.09	2.2	125	0.08	2.2	195	0.09	2.2	630	0.11	2.2	50	0.06	1.8	-	-	-
	M8330	0.2	205	0.09	2.2	120	0.08	2.2	190	0.09	2.2	615	0.11	2.2	50	0.06	1.8	-	-	-
	M8340	0.2	185	0.09	2.2	110	0.08	2.2	175	0.09	2.2	-	-	-	45	0.06	1.8	-	-	-



Suitability and starting values for cutting speed (vc), feed (f) and depth of cut (ap). Refer to our Machining Calculator app for further calculations.

Product	RE [mm]	P			M			K			N			S			H		
		vc [m/min]	f [mm/tooth]	ap [mm]	vc [m/min]	f [mm/tooth]	ap [mm]	vc [m/min]	f [mm/tooth]	ap [mm]	vc [m/min]	f [mm/tooth]	ap [mm]	vc [m/min]	f [mm/tooth]	ap [mm]	vc [m/min]	f [mm/tooth]	ap [mm]

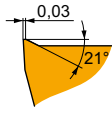

M geometry with positive design for light to medium machining.

ADMX 070204SR-M	8215	0.4	225	0.09	2.2	135	0.08	2.2	210	0.09	2.2	675	0.11	2.2	55	0.06	1.8	-	-	-
	M6330	0.4	190	0.09	2.2	135	0.08	2.2	-	-	-	-	-	-	55	0.06	1.8	-	-	-
	M8310	0.4	245	0.09	2.2	120	0.08	2.2	230	0.09	2.2	-	-	-	-	-	-	-	-	-
	M8330	0.4	240	0.09	2.2	130	0.08	2.2	205	0.09	2.2	660	0.11	2.2	55	0.06	1.8	-	-	-
	M8340	0.4	200	0.09	2.2	120	0.08	2.2	190	0.09	2.2	-	-	-	50	0.06	1.8	-	-	-
ADMX 070208SR-M	M9340	0.4	265	0.09	2.2	155	0.08	2.2	-	-	-	-	-	65	0.06	1.8	-	-	-	
	8215	0.8	270	0.09	2.2	160	0.08	2.2	255	0.09	2.2	810	0.11	2.2	65	0.06	1.8	-	-	-
	M6330	0.8	225	0.09	2.2	160	0.08	2.2	-	-	-	-	-	65	0.06	1.8	-	-	-	
	M8310	0.8	290	0.09	2.2	145	0.08	2.2	275	0.09	2.2	-	-	-	-	-	-	-	-	
	M8330	0.8	260	0.09	2.2	155	0.08	2.2	245	0.09	2.2	780	0.11	2.2	65	0.06	1.8	-	-	-
M8340	0.8	240	0.09	2.2	140	0.08	2.2	225	0.09	2.2	-	-	-	60	0.06	1.8	-	-	-	
M9340	0.8	315	0.09	2.2	185	0.08	2.2	-	-	-	-	-	75	0.06	1.8	-	-	-		
ADMX 070212SR-M	M8340	1.2	250	0.09	2.2	150	0.08	2.2	235	0.09	2.2	-	-	-	60	0.06	1.8	-	-	-
ADMX 070216SR-M	M8310	1.6	320	0.09	2.2	160	0.08	2.2	300	0.09	2.2	-	-	-	-	-	-	-	-	
	M8330	1.6	290	0.09	2.2	170	0.08	2.2	275	0.09	2.2	870	0.11	2.2	70	0.06	1.8	-	-	-
	M8340	1.6	265	0.09	2.2	155	0.08	2.2	250	0.09	2.2	-	-	-	65	0.06	1.8	-	-	-
ADMX 070220SR-M	M6330	2.0	260	0.09	2.2	185	0.08	2.2	-	-	-	-	-	75	0.06	1.8	-	-	-	
	M8310	2.0	340	0.09	2.2	170	0.08	2.2	320	0.09	2.2	-	-	-	-	-	-	-	-	
	M8330	2.0	300	0.09	2.2	180	0.08	2.2	285	0.09	2.2	900	0.11	2.2	75	0.06	1.8	-	-	-
	M8340	2.0	275	0.09	2.2	165	0.08	2.2	260	0.09	2.2	-	-	-	65	0.06	1.8	-	-	-

ADEX 07-HF



	W1 [mm]	D1 [mm]	L [mm]	S [mm]
0702	4.439	2.20	6.45	2.48

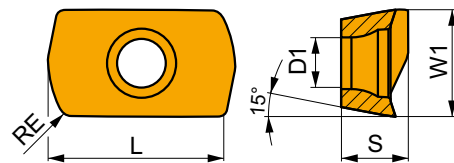

Suitability and starting values for cutting speed (vc), feed (f) and depth of cut (ap). Refer to our Machining Calculator app for further calculations.

Product	RE [mm]	P			M			K			N			S			H		
		vc [m/min]	f [mm/tooth]	ap [mm]	vc [m/min]	f [mm/tooth]	ap [mm]	vc [m/min]	f [mm/tooth]	ap [mm]	vc [m/min]	f [mm/tooth]	ap [mm]	vc [m/min]	f [mm/tooth]	ap [mm]	vc [m/min]	f [mm/tooth]	ap [mm]

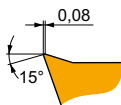

HF geometry with highly positive design for high feed machining.

ADEX 070206SR-HF	M6330	0.6	200	0.60	0.3	140	0.54	0.3	-	-	-	-	-	-	-	-	-	-	-
	M8330	0.6	225	0.60	0.3	135	0.54	0.3	-	-	-	-	-	-	-	-	-	-	-
	M8340	0.6	215	0.60	0.3	125	0.54	0.3	-	-	-	-	-	-	-	-	-	-	-



ADEX 07-FA



	W1	D1	L	S
	[mm]	[mm]	[mm]	[mm]
0702	4.497	2.20	6.95	2.48

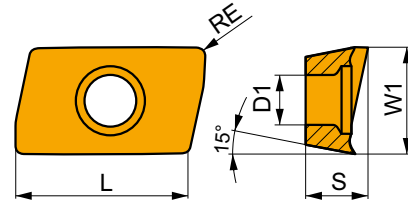

Suitability and starting values for cutting speed (vc), feed (f) and depth of cut (ap). Refer to our Machining Calculator app for further calculations.

Product	RE [mm]	P			M			K			N			S			H		
		vc [m/min]	f [mm/tooth]	ap [mm]	vc [m/min]	f [mm/tooth]	ap [mm]	vc [m/min]	f [mm/tooth]	ap [mm]	vc [m/min]	f [mm/tooth]	ap [mm]	vc [m/min]	f [mm/tooth]	ap [mm]	vc [m/min]	f [mm/tooth]	ap [mm]

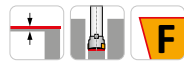
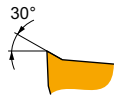

FA geometry with highly positive design for fine-finish to medium machining.

ADEX 070204FR-FA	HF7	0.4	-	-	-	-	-	-	-	240	0.18	3.0	-	-	-	-	-	-
	M0315	0.4	-	-	-	-	-	-	-	555	0.18	3.0	-	-	-	-	-	-
ADEX 070208FR-FA	HF7	0.8	-	-	-	-	-	-	-	285	0.18	3.0	-	-	-	-	-	-



a_s DC	5%	10%	15%	20%	25%	30%	40%	50%	60%	70%	75%	80%	90%	100%
	1.48	1.35	1.27	1.22	1.19	1.16	1.11	1.08	1.05	1.03	1.00	1.00	1.00	1.00
	2.20	1.60	1.35	1.20	1.10	0.95	0.85	0.75	0.85	0.95	1.00	1.00	1.00	1.00
	0.64	0.64	0.64	0.64	0.64	0.65	0.65	0.67	0.68	0.71	0.72	0.74	0.79	1.00

	ADMX 07-F	ADMX 07-M								ADEX 07-HF	ADEX 07-FA	
	0.2	0.4	0.8	0.2	0.4	0.8	1.2	1.6	2.0	0.6	0.4	0.8
	1.38	0.89	0.54	1.38	0.89	0.54	1.07	0.7	0.33	–	0.94	0.55

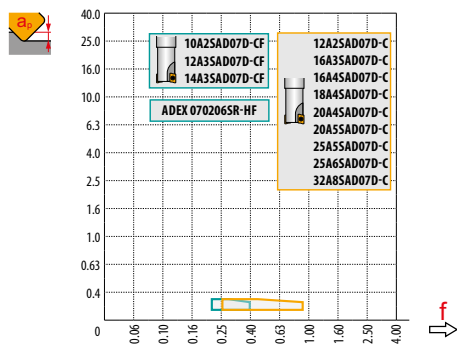
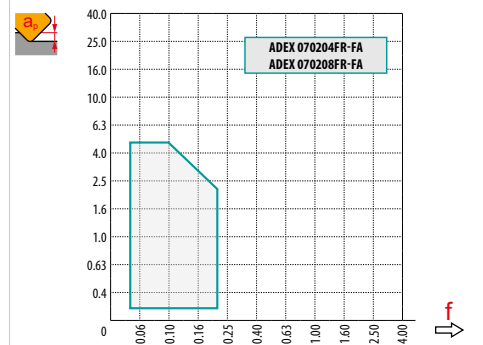
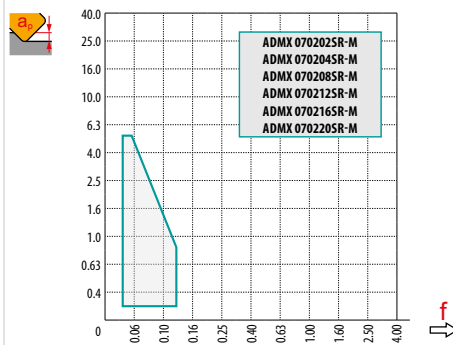
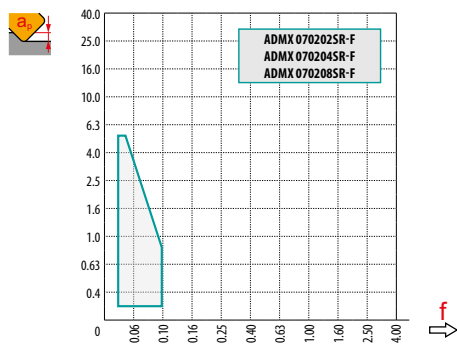

		ADEX 07-HF			
		0	0.1	0.2	0.3
10		5.6	7.8	8.7	9.4
12		7.6	9.8	10.7	11.4
14		9.6	11.8	12.7	13.4
16		11.6	13.8	14.7	15.4
18		13.6	15.8	16.7	17.4
20		15.6	17.8	18.7	19.4
25		20.6	22.8	23.7	24.4
32	27.6	29.8	30.7	31.4	

		HFC		
		0.1	0.2	0.3
		0.9	0.8	0.6



3.0

				HFC		
	1.0	3.0	5.0	0.1	0.2	0.3
	0.13	0.08	0.05	0.7	0.6	0.4



		HFC		
DC	RPMX	APMX/I	RPMX	APMX/I
10	5.2	5.0/56	3.5	0.3/6
12	3.4	5.0/86	2.2	0.3/9
14	2.5	4.2/100	1.6	0.3/12
16	1.9	3.2/100	1.3	0.3/15
18	1.7	2.8/100	1.1	0.3/17
20	1.5	2.5/100	0.9	0.3/21
25	1.1	1.8/100	0.7	0.3/26
32	0.8	1.2/100	0.5	0.3/36



					HFC			
DC	DMIN	DMAX			DMIN	DMAX		
10	12.0	20.0	0.5	2.8	12	20	0.30	0.30
12	16.0	24.0	0.7	2.2	16	24	0.30	0.30
14	20.0	28.0	0.8	1.9	20	28	0.30	0.30
16	24.0	32.0	0.8	1.6	24	32	0.30	0.30
18	28.0	36.0	0.9	1.6	28	36	0.30	0.30
20	32.0	40.0	0.9	1.6	32	40	0.30	0.30
25	42.0	50.0	1.0	1.5	42	50	0.30	0.30
32	56.0	64.0	1.0	1.4	56	64	0.30	0.30



0.5



HFC

0.3



DC	μm	3	5	10	15	20	30	40	50	60	80	100
10		0.346	0.447	0.632	0.775	0.894	1.095	1.265	1.414	1.549	1.789	2.000
12		0.379	0.490	0.693	0.849	0.980	1.200	1.386	1.549	1.697	1.960	2.191
14		0.410	0.529	0.748	0.917	1.058	1.296	1.497	1.673	1.833	2.117	2.366
16		0.438	0.566	0.800	0.980	1.131	1.386	1.600	1.789	1.960	2.263	2.530
18		0.465	0.600	0.849	1.039	1.200	1.470	1.697	1.897	2.078	2.400	2.683
20		0.490	0.632	0.894	1.095	1.265	1.549	1.789	2.000	2.191	2.530	2.828
25		0.548	0.707	1.000	1.225	1.414	1.732	2.000	2.236	2.449	2.828	3.162
32		0.620	0.800	1.131	1.386	1.600	1.960	2.263	2.530	2.771	3.200	3.578

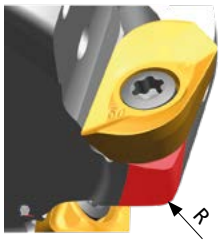

ADMX 07	R
ADMX 070216SR-M	1
ADMX 070220SR-M	1.5
ADEX 070206SR-HF	1

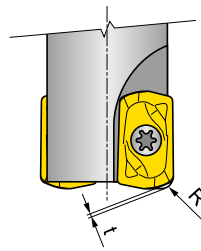

ADEX 07	R	t
ADEX 070206SR-HF	0.8	0.18



SAD11E



PRAMET

S



FORCE AD11 Square Shoulder Mill with Internal Coolant

90° end and shell mills utilising positive AD.. 11 style insert with APMX of 9 mm. Suitable for face, shoulder, slot, helical, trochoidal, ramping and plunge milling. Available in cylindrical, Weldon, Morse taper, modular and arbor (with differential tooth pitch) style, in Ø16 up to Ø125 mm. Body treated for longer tool life.

FORCE AD

KAPR	90°
APMX	9.0 mm

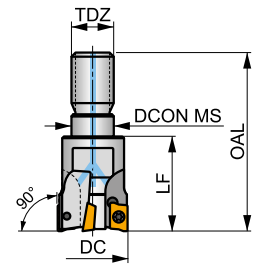
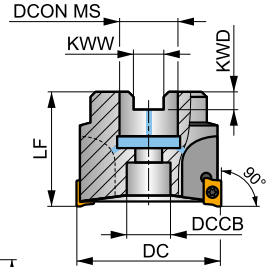
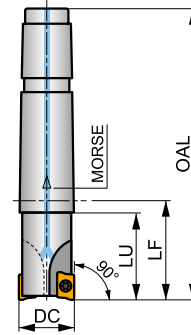
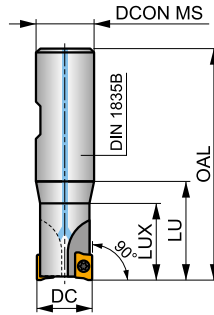
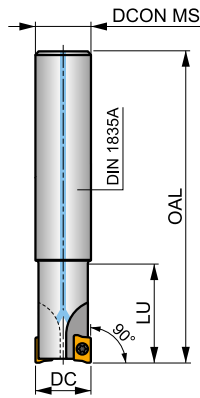
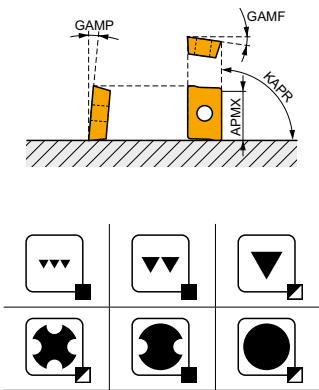

	0.08 - 0.16
	0.06 - 0.13



Product	DC	OAL	DCON MS	DCCB	LU	LUX	LF	TDZ	CZC MS	KWW	KWD	GAMF	GAMP								
	[mm]	[mm]	[mm]	[mm]	[mm]	[mm]	[mm]			[mm]	[mm]	[°]	[°]								
16A2R024A14-SAD11E-C	16	160	14	-	24	-	-	-	-	-	-	-12.8	4	2	-	30100	✓	0.21	G1169	SQ025	-
16A2R024A16-SAD11E-C	16	135	16	-	24	-	-	-	-	-	-	-12.8	4	2	-	30100	✓	0.19	G1169	SQ025	-
16A2R050A16-SAD11E-C	16	135	16	-	50	-	-	-	-	-	-	-12.8	4	2	-	30100	✓	0.20	G1169	SQ025	-
18A2R029A20-SAD11E-C	18	150	20	-	29	-	-	-	-	-	-	-12	4.5	2	-	28400	✓	0.35	G1169	SQ025	-
20A2R029A20-SAD11E-C	20	150	20	-	29	-	-	-	-	-	-	-11.5	5	2	-	27000	✓	0.33	G1169	SQ020	-
20A2R070A20-SAD11E-C	20	150	20	-	70	-	-	-	-	-	-	-11.5	5	2	-	27000	✓	0.32	G1169	SQ020	-
20A3R029A18-SAD11E-C	20	200	18	-	29	-	-	-	-	-	-	-11.5	5	3	-	27000	✓	0.38	G1169	SQ025	-
20A3R029A20-SAD11E-C	20	150	20	-	29	-	-	-	-	-	-	-11.5	5	3	-	27000	✓	0.33	G1169	SQ025	-
22A3R029A20-SAD11E-C	22	200	20	-	29	-	-	-	-	-	-	-11.5	5	3	-	25600	✓	0.49	G1169	SQ025	-
25A3R034A25-SAD11E-C	25	170	25	-	34	-	-	-	-	-	-	-10.2	5	3	-	24100	✓	0.42	G1169	SQ020	-
25A3R080A25-SAD11E-C	25	170	25	-	80	-	-	-	-	-	-	-10.2	5	3	-	24100	✓	0.55	G1169	SQ020	-
25A4R034A25-SAD11E-C	25	170	25	-	34	-	-	-	-	-	-	-10.2	5	4	-	24100	✓	0.42	G1169	SQ025	-
25A4R040A25-SAD11E-C	25	250	25	-	40	-	-	-	-	-	-	-10.2	5	4	-	24100	✓	0.86	G1169	SQ025	-
30A3R080A32-SAD11E-C	30	200	32	-	80	-	-	-	-	-	-	-9.3	7	3	-	22000	✓	1.02	G1169	SQ020	-
32A3R090A32-SAD11E-C	32	195	32	-	90	-	-	-	-	-	-	-9	5	3	-	21300	✓	1.01	G1169	SQ020	-
32A5R034A32-SAD11E-C	32	195	32	-	34	-	-	-	-	-	-	-9	8	5	-	21300	✓	1.03	G1169	SQ025	-
35A5R025A32-SAD11E-C	35	200	32	-	25	-	-	-	-	-	-	-9	8	5	-	20300	✓	1.16	G1169	SQ020	-
16A2R027B16-SAD11E-C	16	75	16	-	27	-	-	-	-	-	-	-12.8	4	2	-	30100	✓	0.09	G1169	SQ025	-
20A2R032B20-SAD11E-C	20	82	20	-	32	-	-	-	-	-	-	-11.5	5	2	-	27000	✓	0.13	G1169	SQ020	-
20A3R032B20-SAD11E-C	20	82	20	-	32	-	-	-	-	-	-	-11.5	5	3	-	27000	✓	0.13	G1169	SQ025	-
25A3R042B25-SAD11E-C	25	98	25	-	42	-	-	-	-	-	-	-10.2	5	3	-	24100	✓	0.29	G1169	SQ020	-
25A4R042B25-SAD11E-C	25	98	25	-	42	-	-	-	-	-	-	-10.2	5	4	-	24100	✓	0.31	G1169	SQ025	-
32A4R042B32-SAD11E-C	32	102	32	-	42	-	-	-	-	-	-	-9	8	4	-	21300	✓	0.27	G1169	SQ020	-
32A5R042B32-SAD11E-C	32	102	32	-	42	-	-	-	-	-	-	-9	8	5	-	21300	✓	0.52	G1169	SQ025	-
16A2R030E02-SAD11E-C	16	94	-	-	25	-	30	-	2	-	-	-12.8	4	2	-	30100	✓	0.15	G1169	SQ025	-
20A3R035E03-SAD11E-C	20	116	-	-	30	-	35	-	3	-	-	-11.5	5	3	-	27000	✓	0.28	G1169	SQ025	-
25A4R043E03-SAD11E-C	25	124	-	-	38	-	43	-	3	-	-	-10.2	5	4	-	24100	✓	0.32	G1169	SQ025	-



Product	DC	OAL	D CON MS	DCCB	LU	LUX	LF	TDZ	CZC MS	KWW	KWD	GAMF	GAMP									
	[mm]	[mm]	[mm]	[mm]	[mm]	[mm]	[mm]			[mm]	[mm]	[°]	[°]									
16A2R024M08-SAD11E-C	16	38	8.5	-	-	-	24	M8	-	-	-	-12.8	4	2	-	-	✓	0.04	GI169	SQ025	-	-
20A2R026M10-SAD11E-C	20	45	11	-	-	-	26	M10	-	-	-	-11.5	5	2	-	-	✓	0.09	GI169	SQ020	-	-
20A3R026M10-SAD11E-C	20	45	10.5	-	-	-	26	M10	-	-	-	-11.5	5	3	-	-	✓	0.06	GI169	SQ025	-	-
25A3R033M12-SAD11E-C	25	55	12.5	-	-	-	33	M12	-	-	-	-10.2	5	3	-	-	✓	0.15	GI169	SQ020	-	-
25A4R033M12-SAD11E-C	25	55	12.5	-	-	-	33	M12	-	-	-	-10.2	5	4	-	-	✓	0.09	GI169	SQ025	-	-
32A4R043M16-SAD11E-C	32	66	17	-	-	-	43	M16	-	-	-	-9	8	4	-	-	✓	0.21	GI169	SQ020	-	-
32A5R043M16-SAD11E-C	32	66	17	-	-	-	43	M16	-	-	-	-9	8	5	-	-	✓	0.19	GI169	SQ025	-	-
40A4R043M16-SAD11E-C	40	66	17	-	-	-	43	M16	-	-	-	-8.1	11	4	-	-	✓	0.27	GI169	SQ020	-	-
40A6R043M16-SAD11E-C	40	66	17	-	-	-	43	M16	-	-	-	-8.1	11	6	-	-	✓	0.21	GI169	SQ020	-	-
40A04R-S90AD11E-C	40	-	16	14	-	-	40	-	-	8.4	5.6	-8.1	11	4	✓	19100	✓	0.16	GI169	SQ022	-	-
40A05R-S90AD11E-C	40	-	16	14	-	-	40	-	-	8.4	5.6	-8.1	11	5	✓	19000	✓	0.32	GI169	SQ022	-	-
40A06R-S90AD11E-C	40	-	16	14	-	-	40	-	-	8.4	5.6	-8.1	11	6	✓	19100	✓	0.16	GI169	SQ022	-	-
50A05R-S90AD11E-C	50	-	22	18	-	-	40	-	-	10.4	6.3	-7.2	12	5	✓	17000	✓	0.31	GI169	SQ023	-	-
50A07R-S90AD11E-C	50	-	22	18	-	-	40	-	-	10.4	6.3	-7.2	12	7	✓	17000	✓	0.45	GI169	SQ023	-	-
63A06R-S90AD11E-C	63	-	22	18	-	-	40	-	-	10.4	6.3	-6.5	12	6	✓	15200	✓	0.54	GI169	SQ023	-	-
63A09R-S90AD11E-C	63	-	22	18	-	-	40	-	-	10.4	6.3	-6.5	12	9	✓	15200	✓	0.63	GI169	SQ023	-	-
80A10R-S90AD11E-C	80	-	27	38	-	-	50	-	-	12.4	7	-6	12	10	✓	13500	✓	1.05	GI169	SQ021	AC001	-
100A11R-S90AD11E-C	100	-	32	45	-	-	50	-	-	14.4	8	-5.5	12	11	✓	12100	✓	1.89	GI169	SQ021	AC002	-
125A12R-S90AD11E-C	125	-	40	56	-	-	63	-	-	16.4	9	-5.2	12	12	✓	10800	✓	2.97	GI169	SQ021	AC003	-

GI169	ADMX 11T3..	ADEX 11T3..

SQ020	US 62506-T07P	1.2	M 2.5	6	-	-	-	Flag T07P
SQ021	US 62506-T07P	1.2	M 2.5	6	D-T07P/T09P	FG-15	-	-
SQ022	US 62506-T07P	1.2	M 2.5	6	D-T07P/T09P	FG-15	-	HS 0830C
SQ023	US 62506-T07P	1.2	M 2.5	6	D-T07P/T09P	FG-15	-	HS 1030C
SQ025	US 62505-T07P	1.2	M 2.5	5	-	-	-	Flag T07P

AC001	KS 1230	K.FMH27
AC002	KS 1635	K.FMH32
AC003	KS 2040	K.FMH40



ADMX 11



	W1	D1	L	S
	[mm]	[mm]	[mm]	[mm]
11T3	6.530	2.90	11.00	3.97

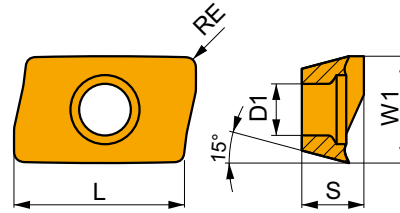

Suitability and starting values for cutting speed (vc), feed (f) and depth of cut (ap). Refer to our Machining Calculator app for further calculations.

Product	RE	P			M			K			N			S			H		
		vc	f	ap	vc	f	ap	vc	f	ap	vc	f	ap	vc	f	ap	vc	f	ap
	[mm]	[m/min]	[mm/tooth]	[mm]	[m/min]	[mm/tooth]	[mm]	[m/min]	[mm/tooth]	[mm]	[m/min]	[mm/tooth]	[mm]	[m/min]	[mm/tooth]	[mm]	[m/min]	[mm/tooth]	[mm]

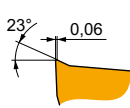
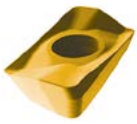

F geometry with very sharp positive design for light machining.

ADMX 11T304SR-F	8215	0.4	█ 245	0.10	2.0	✓ 145	0.09	2.0	█ 230	0.10	2.0	█ 735	0.12	2.0	█ 60	0.08	1.6	-	-	-
	M8310	0.4	█ 270	0.10	2.0	✓ 135	0.09	2.0	█ 255	0.10	2.0	-	-	-	-	-	-	-	-	-
	M8330	0.4	█ 240	0.10	2.0	✓ 140	0.09	2.0	█ 225	0.10	2.0	█ 720	0.12	2.0	█ 60	0.08	1.6	-	-	-
	M8340	0.4	█ 220	0.10	2.0	✓ 130	0.09	2.0	█ 205	0.10	2.0	-	-	-	█ 55	0.08	1.6	-	-	-
	M9340	0.4	█ 285	0.10	2.0	✓ 170	0.09	2.0	-	-	-	-	-	-	█ 70	0.08	1.6	-	-	-
ADMX 11T308SR-F	8215	0.8	█ 290	0.10	2.0	✓ 170	0.09	2.0	█ 275	0.10	2.0	█ 870	0.12	2.0	█ 70	0.08	1.6	-	-	-
	M8330	0.8	█ 285	0.10	2.0	✓ 170	0.09	2.0	█ 270	0.10	2.0	█ 855	0.12	2.0	█ 70	0.08	1.6	-	-	-
	M8340	0.8	█ 260	0.10	2.0	✓ 155	0.09	2.0	█ 245	0.10	2.0	-	-	-	█ 65	0.08	1.6	-	-	-
	M9340	0.8	█ 340	0.10	2.0	✓ 200	0.09	2.0	-	-	-	-	-	-	█ 85	0.08	1.6	-	-	-

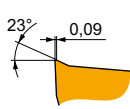
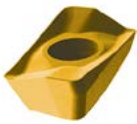

M geometry with positive design for light to medium machining.

ADMX 11T302SR-M	M8330	0.2	█ 190	0.15	4.0	█ 110	0.14	4.0	█ 180	0.15	4.0	-	-	-	█ 45	0.12	3.2	-	-	-	
	M8340	0.2	█ 170	0.15	4.0	█ 100	0.14	4.0	█ 160	0.15	4.0	-	-	-	█ 40	0.12	3.2	-	-	-	
ADMX 11T304SR-M	8215	0.4	█ 205	0.15	4.0	✓ 120	0.14	4.0	█ 190	0.15	4.0	-	-	-	█ 50	0.12	3.2	-	-	-	
	M8310	0.4	█ 220	0.15	4.0	✓ 110	0.14	4.0	█ 205	0.15	4.0	-	-	-	-	-	-	-	-	-	
	M8330	0.4	█ 205	0.15	4.0	█ 120	0.14	4.0	█ 190	0.15	4.0	-	-	-	█ 50	0.12	3.2	-	-	-	
	M8340	0.4	█ 185	0.15	4.0	█ 110	0.14	4.0	█ 175	0.15	4.0	-	-	-	█ 45	0.12	3.2	-	-	-	
	M9325	0.4	█ 255	0.15	4.0	-	-	-	█ 240	0.15	4.0	-	-	-	-	-	-	-	-	-	-
ADMX 11T308SR-M	M9340	0.4	█ 235	0.15	4.0	█ 140	0.14	4.0	-	-	-	-	-	-	█ 55	0.12	3.2	-	-	-	
	8215	0.8	█ 245	0.15	4.0	✓ 145	0.14	4.0	█ 230	0.15	4.0	-	-	-	█ 60	0.12	3.2	-	-	-	
	M5315	0.8	█ 335	0.15	4.0	-	-	-	█ 315	0.15	4.0	-	-	-	-	-	-	-	-	-	-
	M8310	0.8	█ 265	0.15	4.0	✓ 135	0.14	4.0	█ 250	0.15	4.0	-	-	-	-	-	-	-	-	-	
	M8330	0.8	█ 245	0.15	4.0	█ 145	0.14	4.0	█ 230	0.15	4.0	-	-	-	█ 60	0.12	3.2	-	-	-	
ADMX 11T310SR-M	M8340	0.8	█ 220	0.15	4.0	█ 130	0.14	4.0	█ 205	0.15	4.0	-	-	-	█ 55	0.12	3.2	-	-	-	
	M9315	0.8	█ 330	0.15	4.0	-	-	-	█ 310	0.15	4.0	-	-	-	-	-	-	-	-	-	-
	M9325	0.8	█ 305	0.15	4.0	-	-	-	█ 285	0.15	4.0	-	-	-	-	-	-	-	-	-	-
	M9340	0.8	█ 275	0.15	4.0	█ 165	0.14	4.0	-	-	-	-	-	-	█ 65	0.12	3.2	-	-	-	
	M8330	1.0	█ 255	0.15	4.0	█ 150	0.14	4.0	█ 240	0.15	4.0	-	-	-	█ 60	0.12	3.2	-	-	-	
ADMX 11T312SR-M	M8340	1.0	█ 230	0.15	4.0	█ 135	0.14	4.0	█ 215	0.15	4.0	-	-	-	█ 55	0.12	3.2	-	-	-	
	8215	1.2	█ 255	0.15	4.0	✓ 150	0.14	4.0	█ 240	0.15	4.0	-	-	-	█ 60	0.12	3.2	-	-	-	
ADMX 11T316SR-M	M8330	1.2	█ 255	0.15	4.0	█ 150	0.14	4.0	█ 240	0.15	4.0	-	-	-	█ 60	0.12	3.2	-	-	-	
	M8340	1.2	█ 230	0.15	4.0	█ 135	0.14	4.0	█ 215	0.15	4.0	-	-	-	█ 55	0.12	3.2	-	-	-	
	8215	1.6	█ 270	0.15	4.0	✓ 160	0.14	4.0	█ 255	0.15	4.0	-	-	-	█ 65	0.12	3.2	-	-	-	
ADMX 11T316SR-M	M6330	1.6	█ 230	0.15	4.0	█ 165	0.14	4.0	-	-	-	-	-	█ 65	0.12	3.2	-	-	-	-	
	M8310	1.6	█ 295	0.15	4.0	✓ 150	0.14	4.0	█ 280	0.15	4.0	-	-	-	-	-	-	-	-	-	
	M8330	1.6	█ 270	0.15	4.0	█ 160	0.14	4.0	█ 255	0.15	4.0	-	-	-	█ 65	0.12	3.2	-	-	-	
	M8340	1.6	█ 240	0.15	4.0	█ 140	0.14	4.0	█ 225	0.15	4.0	-	-	-	█ 60	0.12	3.2	-	-	-	



Suitability and starting values for cutting speed (vc), feed (f) and depth of cut (ap). Refer to our Machining Calculator app for further calculations.

Product	RE (mm)	P			M			K			N			S			H		
		vc [m/min]	f [mm/tooth]	ap [mm]	vc [m/min]	f [mm/tooth]	ap [mm]	vc [m/min]	f [mm/tooth]	ap [mm]	vc [m/min]	f [mm/tooth]	ap [mm]	vc [m/min]	f [mm/tooth]	ap [mm]	vc [m/min]	f [mm/tooth]	ap [mm]

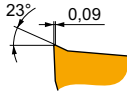
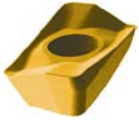

M geometry with positive design for light to medium machining.

ADMX 11T320SR-M	M6330	2.0	240	0.15	4.0	170	0.14	4.0	-	-	-	-	-	-	70	0.12	3.2	-	-	-
	M8330	2.0	280	0.15	4.0	165	0.14	4.0	265	0.15	4.0	-	-	-	70	0.12	3.2	-	-	-
	M8340	2.0	255	0.15	4.0	150	0.14	4.0	240	0.15	4.0	-	-	-	60	0.12	3.2	-	-	-
ADMX 11T325SR-M	M6330	2.5	240	0.15	4.0	170	0.14	4.0	-	-	-	-	-	-	70	0.12	3.2	-	-	-
	M8340	2.5	255	0.15	4.0	150	0.14	4.0	240	0.15	4.0	-	-	-	60	0.12	3.2	-	-	-
ADMX 11T330SR-M	M6330	3.0	240	0.15	4.0	170	0.14	4.0	-	-	-	-	-	-	70	0.12	3.2	-	-	-
	M8330	3.0	280	0.15	4.0	165	0.14	4.0	265	0.15	4.0	-	-	-	70	0.12	3.2	-	-	-
	M8340	3.0	255	0.15	4.0	150	0.14	4.0	240	0.15	4.0	-	-	-	60	0.12	3.2	-	-	-

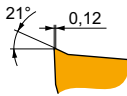
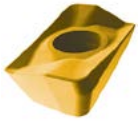

R geometry with positive design for machining conditions in less stable conditions.

ADMX 11T308PR-R	8215	0.8	230	0.18	4.0	135	0.16	4.0	215	0.18	4.0	-	-	-	55	0.16	3.2	45	0.15	1.0
	M5315	0.8	310	0.18	4.0	-	-	-	290	0.18	4.0	-	-	-	-	-	-	60	0.15	1.0
	M8310	0.8	250	0.18	4.0	125	0.16	4.0	235	0.18	4.0	-	-	-	-	-	-	50	0.15	1.0
	M8330	0.8	230	0.18	4.0	135	0.16	4.0	215	0.18	4.0	-	-	-	55	0.16	3.2	45	0.15	1.0
	M8340	0.8	210	0.18	4.0	125	0.16	4.0	195	0.18	4.0	-	-	-	50	0.16	3.2	-	-	-
	M9315	0.8	310	0.18	4.0	-	-	-	290	0.18	4.0	-	-	-	-	-	-	-	60	0.15
ADMX 11T316PR-R	M9325	0.8	290	0.18	4.0	-	-	-	275	0.18	4.0	-	-	-	-	-	-	55	0.15	1.0
	8215	1.6	255	0.18	4.0	150	0.16	4.0	240	0.18	4.0	-	-	-	60	0.16	3.2	50	0.15	1.0
	M8330	1.6	255	0.18	4.0	150	0.16	4.0	240	0.18	4.0	-	-	-	60	0.16	3.2	50	0.15	1.0
M9325	1.6	320	0.18	4.0	-	-	-	300	0.18	4.0	-	-	-	-	-	-	-	60	0.15	1.0

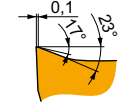

MF geometry with highly positive design for light to finish machining.

ADMX 11T304SR-MF	M6330	0.4	215	0.08	2.5	150	0.07	2.5	-	-	-	-	-	-	60	0.06	2.0	-	-	-
	M8340	0.4	220	0.08	2.5	130	0.07	2.5	-	-	-	-	-	-	55	0.06	2.0	-	-	-
ADMX 11T308SR-MF	M6330	0.8	255	0.08	2.5	180	0.07	2.5	-	-	-	-	-	-	75	0.06	2.0	-	-	-
	M8340	0.8	265	0.08	2.5	155	0.07	2.5	-	-	-	-	-	-	65	0.06	2.0	-	-	-
	M9340	0.8	360	0.08	2.5	215	0.07	2.5	-	-	-	-	-	-	90	0.06	2.0	-	-	-

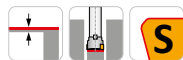
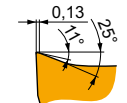

MM geometry with highly positive design for light to medium and finish to semi-rough machining.

ADMX 11T304SR-MM	M6330	0.4	185	0.14	2.5	130	0.13	2.5	-	-	-	-	-	-	55	0.11	2.0	-	-	-
	M8340	0.4	195	0.14	2.5	115	0.13	2.5	-	-	-	-	-	-	45	0.11	2.0	-	-	-
	M9340	0.4	250	0.14	2.5	150	0.13	2.5	-	-	-	-	-	-	60	0.11	2.0	-	-	-
ADMX 11T308SR-MM	M6330	0.8	225	0.14	2.5	155	0.13	2.5	-	-	-	-	-	-	65	0.11	2.0	-	-	-
	M8340	0.8	235	0.14	2.5	140	0.13	2.5	-	-	-	-	-	-	55	0.11	2.0	-	-	-
	M8345	0.8	190	0.14	2.5	110	0.13	2.5	-	-	-	-	-	-	45	0.11	2.0	-	-	-
M9340	0.8	300	0.14	2.5	180	0.13	2.5	-	-	-	-	-	-	75	0.11	2.0	-	-	-	
ADMX 11T312SR-MM	M6330	1.2	235	0.14	2.5	165	0.13	2.5	-	-	-	-	-	-	70	0.11	2.0	-	-	-
	M8340	1.2	245	0.14	2.5	145	0.13	2.5	-	-	-	-	-	-	60	0.11	2.0	-	-	-
	M9340	1.2	315	0.14	2.5	185	0.13	2.5	-	-	-	-	-	-	75	0.11	2.0	-	-	-



ADEX 11-HF



	W1	D1	L	S
	[mm]	[mm]	[mm]	[mm]
11T3	6.450	2.90	10.67	3.82

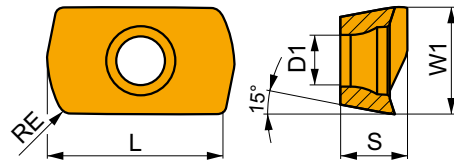

Suitability and starting values for cutting speed (vc), feed (f) and depth of cut (ap). Refer to our Machining Calculator app for further calculations.

Product	RE [mm]	P			M			K			N			S			H		
		vc [m/min]	f [mm/tooth]	ap [mm]	vc [m/min]	f [mm/tooth]	ap [mm]	vc [m/min]	f [mm/tooth]	ap [mm]	vc [m/min]	f [mm/tooth]	ap [mm]	vc [m/min]	f [mm/tooth]	ap [mm]			

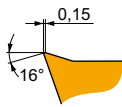

HF geometry with highly positive design for high feed machining.

ADEX 11T308SR-HF	Material	RE	P			M			K			N			S			H		
			vc	f	ap	vc	f	ap	vc	f	ap	vc	f	ap	vc	f	ap			
8215	0.8	0.8	215	0.68	0.4	125	0.61	0.4	—	—	—	—	—	—	—	—	—	—	—	
M6330	0.8	0.8	185	0.68	0.4	130	0.61	0.4	—	—	—	—	—	—	—	—	—	—	—	
M8310	0.8	0.8	220	0.68	0.4	110	0.52	0.4	—	—	—	—	—	—	—	—	—	—	—	
M8330	0.8	0.8	215	0.68	0.4	125	0.61	0.4	—	—	—	—	—	—	—	—	—	—	—	
M8340	0.8	0.8	200	0.68	0.4	120	0.61	0.4	—	—	—	—	—	—	—	—	—	—	—	
M9340	0.8	0.8	220	0.68	0.4	130	0.61	0.4	—	—	—	—	—	—	—	—	—	—	—	

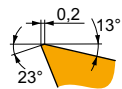

HF2 geometry with positive design for high feed machining.

ADEX 11T308SR-HF2	Material	RE	P			M			K			N			S			H		
			vc	f	ap	vc	f	ap	vc	f	ap	vc	f	ap	vc	f	ap			
M8310	0.8	0.8	220	0.68	0.4	110	0.61	0.4	205	0.68	0.4	—	—	—	—	—	—	40	0.15	1.0
M8330	0.8	0.8	215	0.68	0.4	125	0.61	0.4	200	0.68	0.4	—	—	—	50	0.48	0.3	40	0.15	1.0
M8340	0.8	0.8	200	0.68	0.4	120	0.61	0.4	190	0.68	0.4	—	—	—	50	0.48	0.3	—	—	—
M9325	0.8	0.8	250	0.68	0.4	—	—	—	235	0.68	0.4	—	—	—	—	—	—	50	0.15	1.0
M9340	0.8	0.8	220	0.68	0.4	130	0.61	0.4	—	—	—	—	—	—	55	0.48	0.3	—	—	—



ADEX 11-FA

	W1	D1	L	S
	[mm]	[mm]	[mm]	[mm]
11T3	6.450	2.90	9.70	3.91

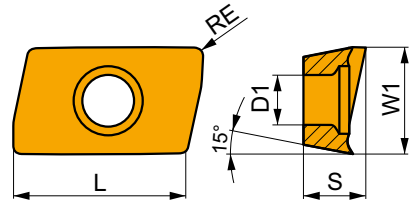

Suitability and starting values for cutting speed (vc), feed (f) and depth of cut (ap). Refer to our Machining Calculator app for further calculations.

Product	RE [mm]	P			M			K			N			S			H		
		vc [m/min]	f [mm/tooth]	ap [mm]	vc [m/min]	f [mm/tooth]	ap [mm]	vc [m/min]	f [mm/tooth]	ap [mm]	vc [m/min]	f [mm/tooth]	ap [mm]	vc [m/min]	f [mm/tooth]	ap [mm]			

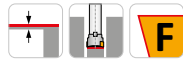
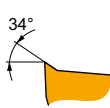

FA geometry with highly positive design for fine-finish to medium machining.

ADEX 11T304FR-FA	HF7	0.4	—	—	—	—	—	—	—	—	■	210	0.30	5.0	—	—	—	—	—	—
	M0315	0.4	—	—	—	—	—	—	—	—	■	480	0.30	5.0	—	—	—	—	—	—
ADEX 11T308FR-FA	HF7	0.8	—	—	—	—	—	—	—	—	■	240	0.30	5.0	—	—	—	—	—	—
	M0315	0.8	—	—	—	—	—	—	—	—	■	570	0.30	5.0	—	—	—	—	—	—
ADEX 11T312FR-FA	HF7	1.2	—	—	—	—	—	—	—	—	■	255	0.30	5.0	—	—	—	—	—	—
	M0315	1.2	—	—	—	—	—	—	—	—	■	600	0.30	5.0	—	—	—	—	—	—
ADEX 11T316FR-FA	HF7	1.6	—	—	—	—	—	—	—	—	■	270	0.18	5.0	—	—	—	—	—	—

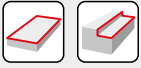

a_e DC	5 %	10 %	15 %	20 %	25 %	30 %	40 %	50 %	60 %	70 %	75 %	80 %	90 %	100 %
	1.48	1.35	1.27	1.22	1.19	1.16	1.11	1.08	1.05	1.03	1.00	1.00	1.00	1.00
	2.20	1.60	1.35	1.20	1.10	0.95	0.85	0.75	0.85	0.95	1.00	1.00	1.00	1.00
	0.64	0.64	0.64	0.64	0.64	0.65	0.65	0.67	0.68	0.71	0.72	0.74	0.79	1.00

	ADMX 11-F		ADMX 11-M								ADMX 11-R		ADMX 11-MF		
	0.4	0.8	0.2	0.4	0.8	1.0	1.2	1.6	2.0	2.5	3.0	0.8	1.6	0.4	0.8
	1.89	1.48	2.09	1.89	1.48	1.27	1.08	0.68	1.61	1.13	0.66	1.48	0.68	1.89	1.48

	ADMX 11-MM				ADEX 11-HF	ADEX 11-HF2	ADEX 11-FA			
	0.4	0.8	1.2	1.6	0.8	0.8	0.4	0.8	1.2	1.6
	1.89	1.48	1.08	0.61	0.17	0.17	1.77	1.39	1.0	0.62

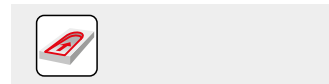
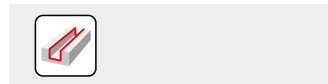
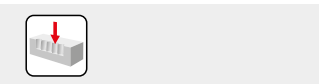
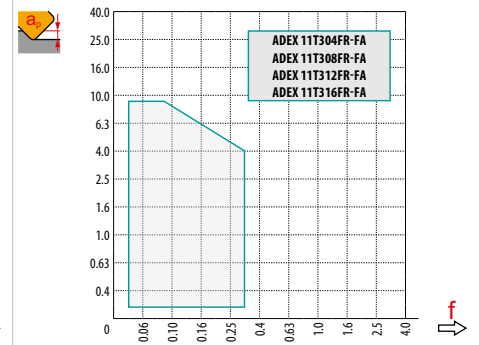
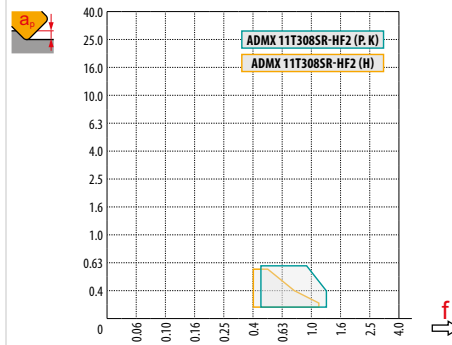
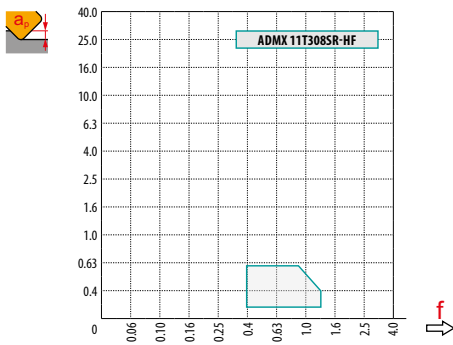
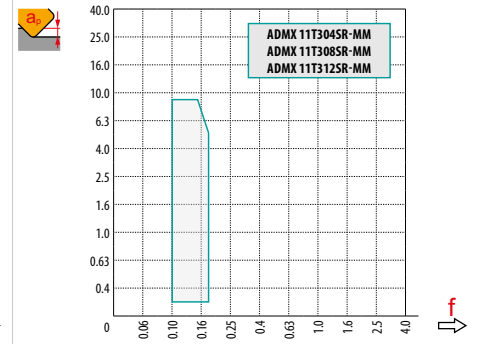
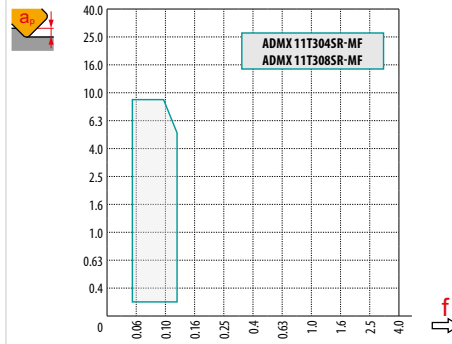
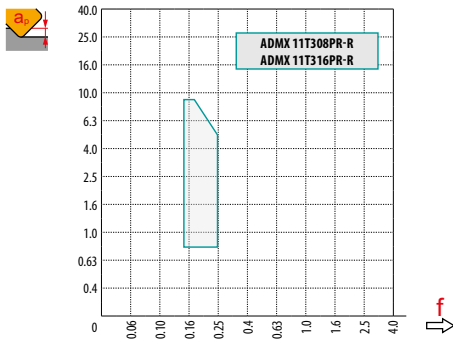
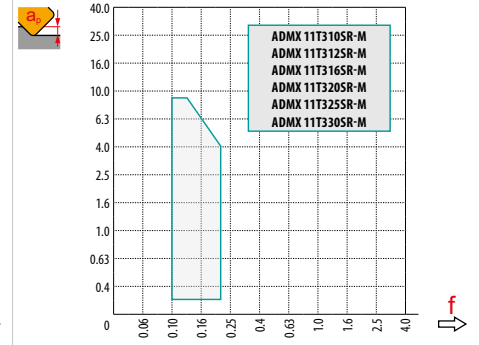
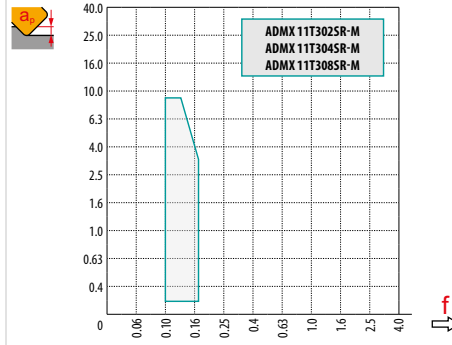
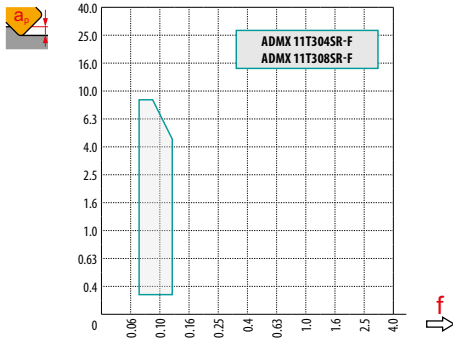

max
4.5

	1.0	5.0	9.0
	0.20	0.13	0.10

DC	HFC				
	RPMX	APMX/l	RPMX	RPMX	APMX/l
16	13.5	9.0/40	4.1	5.7	0.6/8
18	10.0	9.0/53	2.8	4.5	0.6/12
20	9.0	9.0/59	2.3	4.3	0.6/15
25	6.0	9.0/87	1.3	6.7	0.6/26
32	5.3	9.0/99	0.7	4.3	0.6/49
40	3.8	6.5/100	0.3	2.9	0.6/100
50	2.8	4.7/100	0.1	2.1	0.6/100
63	1.8	3.0/100	-	-	-
80	1.6	2.6/100	-	-	-

* HFC milling
** Conventional milling



DC	HFC							
	DMIN	DMAX	SMAX DMIN	SMAX DMAX	DMIN	DMAX	SMAX DMIN	SMAX DMAX
16	27.0	32.0	8.3	9.0	21.0	32.0	0.6	0.6
18	32.0	36.0	7.5	9.0	29.0	36.0	0.6	0.6
20	35.0	40.0	7.5	9.0	29.0	40.0	0.6	0.6
25	45.0	50.0	6.5	7.5	39.0	50.0	0.6	0.6
32	59.0	64.0	4.0	4.5	53.0	64.0	0.6	0.6
40	75.0	80.0	1.5	2.0	68.5	80.0	0.6	0.6
50	-	-	-	-	88.5	100.0	0.6	0.6

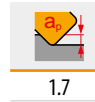

DC	μm	3	5	10	15	20	30	40	50	60	80	100
16		0.438	0.566	0.800	0.980	1.131	1.386	1.600	1.789	1.960	2.263	2.530
18		0.465	0.600	0.849	1.039	1.200	1.470	1.697	1.897	2.078	2.400	2.683
20		0.490	0.632	0.894	1.095	1.265	1.549	1.789	2.000	2.191	2.530	2.828
20		0.490	0.632	0.894	1.095	1.265	1.549	1.789	2.000	2.191	2.530	2.828
25		0.548	0.707	1.000	1.225	1.414	1.732	2.000	2.236	2.449	2.828	3.162
32		0.620	0.800	1.131	1.386	1.600	1.960	2.263	2.530	2.771	3.200	3.578
40		0.693	0.894	1.265	1.549	1.789	2.191	2.530	2.828	3.098	3.578	4.000
50		0.775	1.000	1.414	1.732	2.000	2.449	2.828	3.162	3.464	4.000	4.472
63		0.869	1.122	1.587	1.944	2.245	2.750	3.175	3.550	3.888	4.490	5.020
80		0.980	1.265	1.789	2.191	2.530	3.098	3.578	4.000	4.382	5.060	5.657

RE	μm	3	5	10	15	20	30	40	50	60	80	100
1.0		0.155	0.200	0.283	0.346	0.400	0.490	0.566	0.632	0.693	0.800	0.894
1.2		0.170	0.219	0.310	0.379	0.438	0.537	0.620	0.693	0.759	0.876	0.980
1.6		0.196	0.253	0.358	0.438	0.506	0.620	0.716	0.800	0.876	1.012	1.131
2.0		0.219	0.283	0.400	0.490	0.566	0.693	0.800	0.894	0.980	1.131	1.265
2.5		0.245	0.316	0.447	0.548	0.632	0.775	0.894	1.000	1.095	1.265	1.414
3.0		0.268	0.346	0.490	0.600	0.693	0.849	0.980	1.095	1.200	1.386	1.549

i

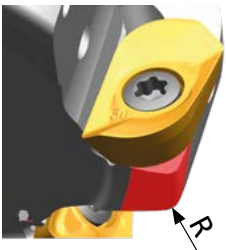

ADMX/ADEX 11	R
ADMX 11T320SR-M	1.0
ADMX 11T325SR-M	1.8
ADMX 11T330SR-M	1.8
ADEX 11T308SR-HF	1.4
ADEX 11T308SR-HF2	1.4

i

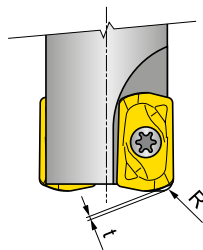

ADEX 11	R	t
ADEX 11T308SR-HF	1.42	0.35
ADEX 11T308SR-HF2	1.34	0.38



SAD16E

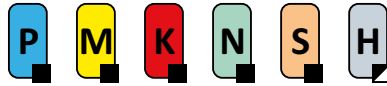

PRAMET

S



FORCE AD16 Square Shoulder Mill with Internal Coolant

90° end and shell mills utilising positive AD.. 16 style insert with APMX of 13 mm. Suitable for face, shoulder, slot, helical, trochoidal, ramping and plunge milling. Available in cylindrical, Weldon, Morse taper, modular and arbor (with differential tooth pitch) style, in Ø25 up to Ø175 mm. Body treated for longer tool life.

FORCE AD

KAPR	90°
APMX	13.0 mm

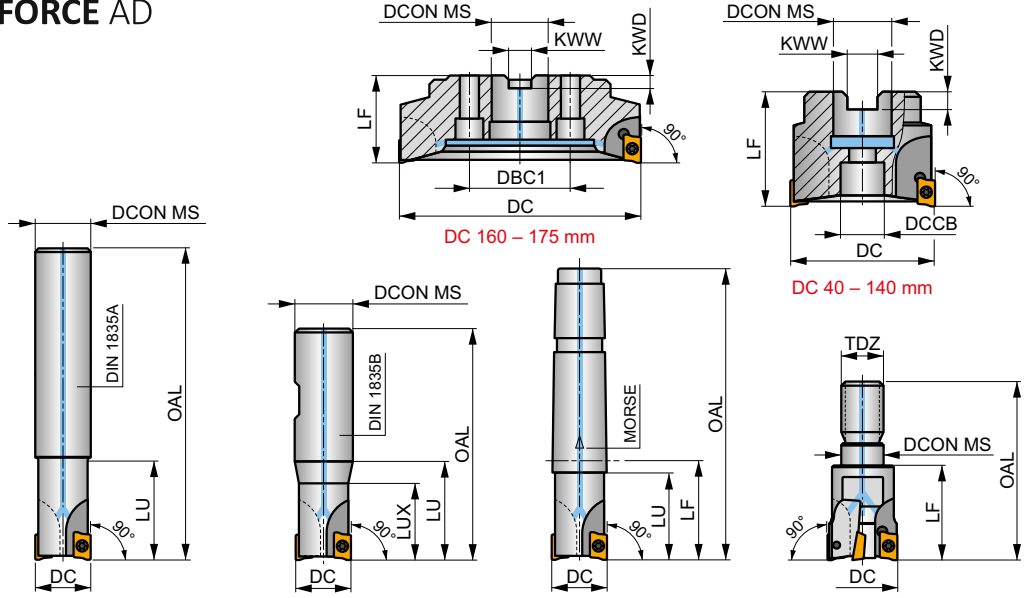
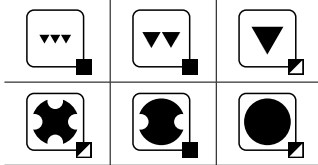
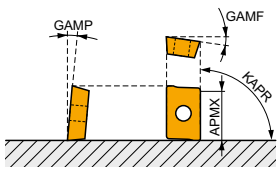

	0.08 - 0.22
	0.06 - 0.18



Product	DC	OAL	DCON MS	DCCB	DBC1	LU	LUX	LF	TDZ	CZC MS	KWW	KWD	GAMF	GAMP	max.			kg	Material	Coating	Other
															��	��	��				
	[mm]	[mm]	[mm]	[mm]	[mm]	[mm]	[mm]	[mm]	[mm]	[mm]	[mm]	[mm]	[°]	[°]							
	25A2R033A25-SAD16E-C	25	165	25	-	-	33	-	-	-	-	-	-13	5	2	-	18700	✓	0.52	GI165 SQ030	-
	25A2R038A25-SAD16E-C	25	200	25	-	-	38	-	-	-	-	-	-13	5	2	-	18700	✓	0.71	GI165 SQ030	-
	32A3R033A32-SAD16E-C	32	195	32	-	-	33	-	-	-	-	-	-12	7	3	-	16500	✓	1.03	GI165 SQ030	-
	32A3R048A32-SAD16E-C	32	250	32	-	-	48	-	-	-	-	-	-12	7	3	-	16500	✓	1.37	GI165 SQ030	-
	25A2R042B25-SAD16E-C	25	98	25	-	-	42	-	-	-	-	-	-13	5	2	-	18700	✓	0.29	GI165 SQ030	-
	32A3R040B32-SAD16E-C	32	100	32	-	-	40	-	-	-	-	-	-12	7	3	-	16500	✓	0.50	GI165 SQ030	-
	40A3R050B32-SAD16E-C	40	110	32	-	-	50	-	-	-	-	-	-8.2	10.5	3	-	14800	✓	0.59	GI165 SQ030	-
	40A4R050B32-SAD16E-C	40	110	32	-	-	50	-	-	-	-	-	-8.2	10.5	4	-	14800	✓	0.65	GI165 SQ030	-
	25A2R043E03-SAD16E-C	25	98	-	-	-	38	-	43	3	-	-	-13	5	2	-	18600	✓	0.31	GI165 SQ030	-
	32A3R043E03-SAD16E-C	32	100	-	-	-	38	-	43	3	-	-	-12	7	3	-	16500	✓	0.33	GI165 SQ030	-
	40A3R054E04-SAD16E-C	40	110	-	-	-	48	-	54	4	-	-	-8.2	10.5	3	-	14700	✓	0.74	GI165 SQ030	-
	40A4R054E04-SAD16E-C	40	110	-	-	-	48	-	54	4	-	-	-8.2	10.5	4	-	14700	✓	0.70	GI165 SQ030	-
	32A3R043M16-SAD16E-C	32	66	17	-	-	-	43	M16	-	-	-	-12	7	3	-	-	✓	0.20	GI165 SQ030	-
	40A4R043M16-SAD16E-C	40	66	17	-	-	-	43	M16	-	-	-	-8.2	10.5	4	-	-	✓	0.27	GI165 SQ030	-
	40A04R-S90AD16E-C	40	-	16	14	-	-	40	-	-	8.4	5.6	-8.2	10.5	4	-	14700	✓	0.21	GI165 SQ032	-
	50A03R-S90AD16E-C	50	-	22	18	-	-	40	-	-	10.4	6.3	-7	11	3	-	13200	✓	0.43	GI165 SQ033	-
	50A05R-S90AD16E-C	50	-	22	18	-	-	40	-	-	10.4	6.3	-7	11	5	✓	13200	✓	0.59	GI165 SQ033	-
	63A04R-S90AD16E-C	63	-	22	18	-	-	40	-	-	10.4	6.3	-6	12	4	✓	11800	✓	0.62	GI165 SQ033	-
	63A06R-S90AD16E-C	63	-	22	18	-	-	40	-	-	10.4	6.3	-6	12	6	✓	11800	✓	0.46	GI165 SQ033	-
	80A05R-S90AD16E-C	80	-	27	38	-	-	50	-	-	12.4	7	-5	12	5	✓	10400	✓	1.01	GI165 SQ031 AC001	-
	80A07R-S90AD16E-C	80	-	27	38	-	-	50	-	-	12.4	7	-5	13	7	✓	10400	✓	0.97	GI165 SQ031 AC001	-
	100A06R-S90AD16E-C	100	-	32	45	-	-	50	-	-	14.4	8	-4	12	6	✓	9300	✓	1.89	GI165 SQ031 AC002	-
	100A08R-S90AD16E-C	100	-	32	45	-	-	50	-	-	14.4	8	-4	12	8	✓	9300	✓	1.69	GI165 SQ031 AC002	-
	125A09R-S90AD16E-C	125	-	40	56	-	-	63	-	-	16.4	9	-3.8	12	9	✓	8400	✓	3.46	GI165 SQ031 AC003	-
	140A08R-S90AD16E-C	140	-	40	56	-	-	63	-	-	16.4	9	-3.8	12	8	✓	7900	✓	4.06	GI165 SQ031	-
	160C10R-S90AD16E-C	160	-	40	-	66.7	-	63	-	-	16.4	9.2	-3.8	10	10	✓	7300	✓	6.04	GI165 SQ036	-
	175C10R-S90AD16E-C	175	-	40	-	66.7	-	63	-	-	16.4	9.2	-3.8	12	10	✓	7000	✓	7.00	GI165 SQ036	-



GI165	ADMX 1606..	ADEX 1606..

SQ030	US 4008-T15P	3.5	M 4	8	–	–	Flag T15P	–	–	–	–
SQ031	US 4011-T15P	3.5	M 4	10.6	D-T08P/T15P	FG-15	–	–	–	–	–
SQ032	US 4008-T15P	3.5	M 4	8	D-T08P/T15P	FG-15	–	HS 0830C	–	–	–
SQ033	US 4011-T15P	3.5	M 4	10.6	D-T08P/T15P	FG-15	–	HS 1030C	–	–	–
SQ036	US 4011-T15P	3.5	M 4	10.6	D-T08P/T15P	FG-15	–	HS 1240C	CAC 160C	HSD 0825C	HXK 5

AC001	KS 1230	K.FMH27
AC002	KS 1635	K.FMH32
AC003	KS 2040	K.FMH40

ADMX 16



	W1	D1	L	S
	[mm]	[mm]	[mm]	[mm]
1606	9.950	4.50	16.00	6.25

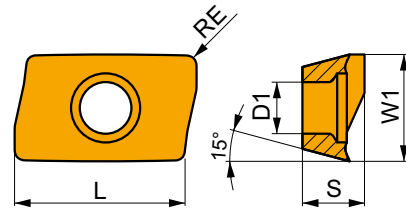

Suitability and starting values for cutting speed (vc), feed (f) and depth of cut (ap). Refer to our Machining Calculator app for further calculations.

Product	RE	P			M			K			N			S			H		
		vc	f	ap	vc	f	ap	vc	f	ap	vc	f	ap	vc	f	ap	vc	f	ap
	[mm]	[m/min]	[mm/tooth]	[mm]	[m/min]	[mm/tooth]	[mm]	[m/min]	[mm/tooth]	[mm]	[m/min]	[mm/tooth]	[mm]	[m/min]	[mm/tooth]	[mm]	[m/min]	[mm/tooth]	[mm]

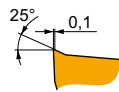
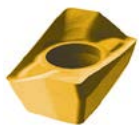

F geometry with highly positive design for light to medium machining.

ADMX 160608SR-F	8215	0.8	■ 265	0.15	2.0	✓ 155	0.14	2.0	✗ 250	0.15	2.0	■ 795	0.18	2.0	■ 65	0.11	1.6	–	–	–
	M8310	0.8	■ 285	0.15	2.0	✓ 145	0.14	2.0	✗ 270	0.15	2.0	–	–	–	–	–	–	–	–	–
	M8330	0.8	■ 260	0.15	2.0	✓ 155	0.14	2.0	✗ 245	0.15	2.0	■ 780	0.18	2.0	■ 65	0.11	1.6	–	–	–
	M8340	0.8	■ 235	0.15	2.0	✓ 140	0.14	2.0	✗ 220	0.15	2.0	–	–	–	■ 55	0.11	1.6	–	–	–
	M9340	0.8	■ 300	0.15	2.0	✓ 180	0.14	2.0	–	–	–	–	–	–	■ 75	0.11	1.6	–	–	–

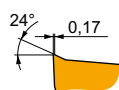
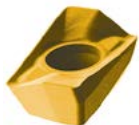

M geometry with positive design for light to medium machining.

ADMX 160604SR-M	8215	0.4	■ 190	0.18	5.0	✓ 110	0.16	5.0	✗ 180	0.18	5.0	–	–	–	■ 45	0.13	4.0	–	–	–
	M8330	0.4	■ 190	0.18	5.0	✓ 110	0.16	5.0	✗ 180	0.18	5.0	–	–	–	■ 45	0.13	4.0	–	–	–
	M8340	0.4	■ 170	0.18	5.0	✓ 100	0.16	5.0	✗ 160	0.18	5.0	–	–	–	■ 40	0.13	4.0	–	–	–



Suitability and starting values for cutting speed (vc), feed (f) and depth of cut (ap). Refer to our Machining Calculator app for further calculations.

Product	RE (mm)	P			M			K			N			S			H		
		vc (m/min)	f (mm/tooth)	ap (mm)	vc (m/min)	f (mm/tooth)	ap (mm)	vc (m/min)	f (mm/tooth)	ap (mm)	vc (m/min)	f (mm/tooth)	ap (mm)	vc (m/min)	f (mm/tooth)	ap (mm)	vc (m/min)	f (mm/tooth)	ap (mm)

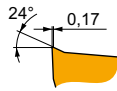
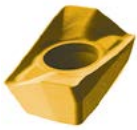

M geometry with positive design for light to medium machining.

ADMX 160608SR-M	8215	0.8	225	0.18	5.0	135	0.16	5.0	210	0.18	5.0	-	-	-	55	0.13	4.0	-	-	-	
	M5315	0.8	305	0.18	5.0	-	-	-	285	0.18	5.0	-	-	-	-	-	-	-	-	-	
	M8310	0.8	250	0.18	5.0	125	0.16	5.0	235	0.18	5.0	-	-	-	-	-	-	-	-	-	
	M8330	0.8	225	0.18	5.0	135	0.16	5.0	210	0.18	5.0	-	-	-	55	0.13	4.0	-	-	-	
	M8340	0.8	205	0.18	5.0	120	0.16	5.0	190	0.18	5.0	-	-	-	50	0.13	4.0	-	-	-	
	M9315	0.8	305	0.18	5.0	-	-	-	285	0.18	5.0	-	-	-	-	-	-	-	-	-	-
	M9325	0.8	280	0.18	5.0	-	-	-	265	0.18	5.0	-	-	-	-	-	-	-	-	-	-
ADMX 160616SR-M	8215	1.6	250	0.18	5.0	150	0.16	5.0	235	0.18	5.0	-	-	-	60	0.13	4.0	-	-	-	
	M8310	1.6	275	0.18	5.0	140	0.16	5.0	260	0.18	5.0	-	-	-	-	-	-	-	-	-	
	M8330	1.6	250	0.18	5.0	150	0.16	5.0	235	0.18	5.0	-	-	-	60	0.13	4.0	-	-	-	
	M8340	1.6	225	0.18	5.0	135	0.16	5.0	210	0.18	5.0	-	-	-	55	0.13	4.0	-	-	-	
	M9325	1.6	310	0.18	5.0	-	-	-	290	0.18	5.0	-	-	-	-	-	-	-	-	-	
ADMX 160620SR-M	M6330	2.0	225	0.18	5.0	155	0.16	5.0	-	-	-	-	-	-	65	0.13	4.0	-	-	-	
	M8330	2.0	265	0.18	5.0	155	0.16	5.0	250	0.18	5.0	-	-	-	65	0.13	4.0	-	-	-	
	M8340	2.0	240	0.18	5.0	140	0.16	5.0	225	0.18	5.0	-	-	-	60	0.13	4.0	-	-	-	
ADMX 160630SR-M	M8330	3.0	265	0.18	5.0	155	0.16	5.0	250	0.18	5.0	-	-	-	65	0.13	4.0	-	-	-	
	M8340	3.0	240	0.18	5.0	140	0.16	5.0	225	0.18	5.0	-	-	-	60	0.13	4.0	-	-	-	
ADMX 160632SR-M	M6330	3.2	225	0.18	5.0	155	0.16	5.0	-	-	-	-	-	-	65	0.13	4.0	-	-	-	
	M8330	3.2	265	0.18	5.0	155	0.16	5.0	250	0.18	5.0	-	-	-	65	0.13	4.0	-	-	-	
	M8340	3.2	240	0.18	5.0	140	0.16	5.0	225	0.18	5.0	-	-	-	60	0.13	4.0	-	-	-	
	M9325	3.2	325	0.18	5.0	-	-	-	305	0.18	5.0	-	-	-	-	-	-	-	-	-	
ADMX 160640SR-M	M6330	4.0	225	0.18	5.0	155	0.16	5.0	-	-	-	-	-	-	65	0.13	4.0	-	-	-	
	M8330	4.0	265	0.18	5.0	155	0.16	5.0	250	0.18	5.0	-	-	-	65	0.13	4.0	-	-	-	
	M8340	4.0	240	0.18	5.0	140	0.16	5.0	225	0.18	5.0	-	-	-	60	0.13	4.0	-	-	-	
ADMX 160650SR-M	M8330	5.0	265	0.18	5.0	155	0.16	5.0	250	0.18	5.0	-	-	-	65	0.13	4.0	-	-	-	
	M8340	5.0	240	0.18	5.0	140	0.16	5.0	225	0.18	5.0	-	-	-	60	0.13	4.0	-	-	-	

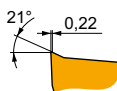

R geometry with positive design for medium to less stable machining conditions.

ADMX 160608PR-R	8215	0.8	205	0.25	6.0	120	0.23	6.0	190	0.25	6.0	-	-	-	50	0.20	4.8	40	0.15	1.0
	M5315	0.8	260	0.25	6.0	-	-	-	245	0.25	6.0	-	-	-	-	-	-	50	0.15	1.0
	M8310	0.8	220	0.25	6.0	110	0.23	6.0	205	0.25	6.0	-	-	-	-	-	-	40	0.15	1.0
	M8330	0.8	205	0.25	6.0	120	0.23	6.0	190	0.25	6.0	-	-	-	50	0.20	4.8	40	0.15	1.0
	M8340	0.8	190	0.25	6.0	110	0.23	6.0	180	0.25	6.0	-	-	-	45	0.20	4.8	-	-	-
	M9315	0.8	265	0.25	6.0	-	-	-	250	0.25	6.0	-	-	-	-	-	-	50	0.15	1.0
	M9325	0.8	250	0.25	6.0	-	-	-	235	0.25	6.0	-	-	-	-	-	-	50	0.15	1.0
ADMX 160616PR-R	M5315	1.6	290	0.25	6.0	-	-	-	275	0.25	6.0	-	-	-	-	-	-	55	0.15	1.0
	M8330	1.6	225	0.25	6.0	135	0.23	6.0	210	0.25	6.0	-	-	-	55	0.20	4.8	45	0.15	1.0
	M8340	1.6	210	0.25	6.0	125	0.23	6.0	195	0.25	6.0	-	-	-	50	0.20	4.8	-	-	-
	M9315	1.6	295	0.25	6.0	-	-	-	280	0.25	6.0	-	-	-	-	-	-	55	0.15	1.0
	M9325	1.6	275	0.25	6.0	-	-	-	260	0.25	6.0	-	-	-	-	-	-	55	0.15	1.0

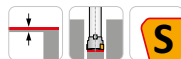
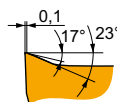



MF geometry with highly positive design for finish machining.

ADMX 160608SR-MF	M6330	0.8	215	0.08	4.0	150	0.07	4.0	-	-	-	-	-	-	60	0.06	3.2	-	-	-
	M8340	0.8	225	0.08	4.0	135	0.07	4.0	-	-	-	-	-	-	55	0.06	3.2	-	-	-
	M9340	0.8	305	0.08	4.0	180	0.07	4.0	-	-	-	-	-	-	75	0.06	3.2	-	-	-



Suitability and starting values for cutting speed (vc), feed (f) and depth of cut (ap). Refer to our Machining Calculator app for further calculations.

Product	RE [mm]	P			M			K			N			S			H				
		vc [m/min]	f [mm/tooth]	ap [mm]	vc [m/min]	f [mm/tooth]	ap [mm]	vc [m/min]	f [mm/tooth]	ap [mm]	vc [m/min]	f [mm/tooth]	ap [mm]	vc [m/min]	f [mm/tooth]	ap [mm]	vc [m/min]	f [mm/tooth]	ap [mm]		
	0.4	M6330	145	0.18	4.0	105	0.16	4.0	—	—	—	—	—	—	—	40	0.14	3.2	—	—	—
		M8340	160	0.18	4.0	95	0.16	4.0	—	—	—	—	—	—	—	40	0.14	3.2	—	—	—
	0.8	M6330	175	0.18	4.0	125	0.16	4.0	—	—	—	—	—	—	50	0.14	3.2	—	—	—	
		M8340	190	0.18	4.0	110	0.16	4.0	—	—	—	—	—	—	45	0.14	3.2	—	—	—	
		M8345	150	0.18	4.0	90	0.16	4.0	—	—	—	—	—	—	35	0.14	3.2	—	—	—	
	1.6	M9340	235	0.18	4.0	140	0.16	4.0	—	—	—	—	—	—	55	0.14	3.2	—	—	—	
		M6330	195	0.18	4.0	140	0.16	4.0	—	—	—	—	—	—	55	0.14	3.2	—	—	—	
		M8340	210	0.18	4.0	125	0.16	4.0	—	—	—	—	—	—	50	0.14	3.2	—	—	—	
		M8345	165	0.18	4.0	95	0.16	4.0	—	—	—	—	—	—	40	0.14	3.2	—	—	—	
		M9340	260	0.18	4.0	155	0.16	4.0	—	—	—	—	—	—	65	0.14	3.2	—	—	—	

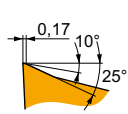

MM geometry with highly positive design for light to medium machining.

ADEX 16



	W1 [mm]	D1 [mm]	L [mm]	S [mm]
1606	9.950	4.50	16.00	6.25

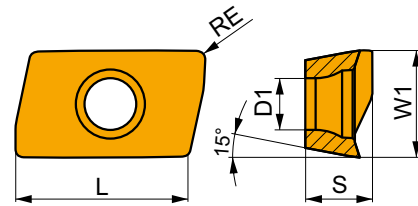

Suitability and starting values for cutting speed (vc), feed (f) and depth of cut (ap). Refer to our Machining Calculator app for further calculations.

Product	RE [mm]	P			M			K			N			S			H			
		vc [m/min]	f [mm/tooth]	ap [mm]	vc [m/min]	f [mm/tooth]	ap [mm]	vc [m/min]	f [mm/tooth]	ap [mm]	vc [m/min]	f [mm/tooth]	ap [mm]	vc [m/min]	f [mm/tooth]	ap [mm]	vc [m/min]	f [mm/tooth]	ap [mm]	
	0.8	8215	260	0.16	2.0	155	0.14	2.0	245	0.16	2.0	—	—	—	65	0.11	1.6	—	—	—
		M8330	255	0.16	2.0	150	0.14	2.0	240	0.16	2.0	—	—	—	60	0.11	1.6	—	—	—
		M8340	235	0.16	2.0	140	0.14	2.0	220	0.16	2.0	—	—	—	55	0.11	1.6	—	—	—

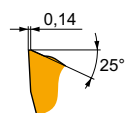

FM geometry with highly positive design for medium machining.



ADEX 16-HF

	W1	D1	L	S
	[mm]	[mm]	[mm]	[mm]
1606	9.950	4.50	16.00	5.88

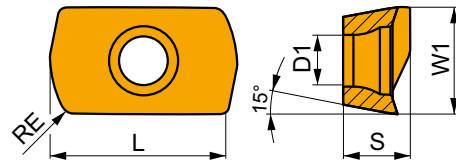

Suitability and starting values for cutting speed (vc), feed (f) and depth of cut (ap). Refer to our Machining Calculator app for further calculations.

Product	RE [mm]	P			M			K			N			S			H		
		vc [m/min]	f [mm/tooth]	ap [mm]	vc [m/min]	f [mm/tooth]	ap [mm]	vc [m/min]	f [mm/tooth]	ap [mm]	vc [m/min]	f [mm/tooth]	ap [mm]	vc [m/min]	f [mm/tooth]	ap [mm]			



HF geometry with highly positive design for high feed machining.

ADEX 160612SR-HF	RE	P			M			K			N			S			H		
		vc	f	ap	vc	f	ap	vc	f	ap	vc	f	ap	vc	f	ap			
8215	1.2	195	1.00	0.6	115	0.90	0.6	-	-	-	-	-	-	-	-	-	-	-	
M8310	1.2	205	1.00	0.6	100	0.77	0.6	-	-	-	-	-	-	-	-	-	-	-	
M8330	1.2	200	1.00	0.6	120	0.90	0.6	-	-	-	-	-	-	-	-	-	-	-	
M8340	1.2	185	1.00	0.6	110	0.90	0.6	-	-	-	-	-	-	-	-	-	-	-	
M9340	1.2	195	1.00	0.6	115	0.90	0.6	-	-	-	-	-	-	-	-	-	-	-	

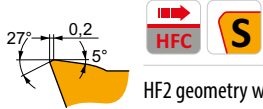

HF2 geometry with positive design for high feed machining.

ADEX 160612SR-HF2	RE	P			M			K			N			S			H		
		vc	f	ap	vc	f	ap	vc	f	ap	vc	f	ap	vc	f	ap			
M8310	1.2	225	0.70	0.6	110	0.63	0.6	210	0.70	0.6	-	-	-	50	0.63	0.5	45	0.15	1.0
M8330	1.2	215	0.70	0.6	125	0.63	0.6	200	0.70	0.6	-	-	-	50	0.63	0.5	40	0.15	1.0
M8340	1.2	205	0.70	0.6	120	0.63	0.6	190	0.70	0.6	-	-	-	50	0.63	0.5	-	-	-
M9325	1.2	245	0.70	0.6	-	-	-	230	0.70	0.6	-	-	-	-	-	-	45	0.15	1.0
M9340	1.2	215	0.70	0.6	125	0.63	0.6	-	-	-	-	-	-	50	0.63	0.5	-	-	-



ADEX 16-FA



	W1	D1	L	S
	[mm]	[mm]	[mm]	[mm]
1606	9.950	4.50	16.00	6.17

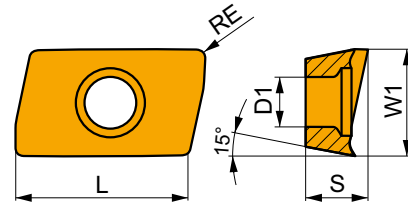

Suitability and starting values for cutting speed (vc), feed (f) and depth of cut (ap). Refer to our Machining Calculator app for further calculations.

Product	RE	P			M			K			N			S			H		
		vc	f	ap	vc	f	ap	vc	f	ap	vc	f	ap	vc	f	ap	vc	f	ap
	[mm]	[m/min]	[mm/tooth]	[mm]	[m/min]	[mm/tooth]	[mm]	[m/min]	[mm/tooth]	[mm]	[m/min]	[mm/tooth]	[mm]	[m/min]	[mm/tooth]	[mm]	[m/min]	[mm/tooth]	[mm]

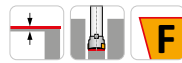
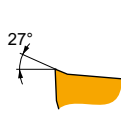

FA geometry with highly positive design for fine-finish to medium machining.

ADEX 160604FR-FA	HF7	0.4	—	—	—	—	—	—	—	—	■	195	0.28	6.0	—	—	—	—	—	—
	M0315	0.4	—	—	—	—	—	—	—	—	■	480	0.28	6.0	—	—	—	—	—	—
ADEX 160608FR-FA	HF7	0.8	—	—	—	—	—	—	—	—	■	240	0.28	6.0	—	—	—	—	—	—
	M0315	0.8	—	—	—	—	—	—	—	—	■	570	0.28	6.0	—	—	—	—	—	—
ADEX 160616FR-FA	HF7	1.6	—	—	—	—	—	—	—	—	■	255	0.28	6.0	—	—	—	—	—	—
	M0315	1.6	—	—	—	—	—	—	—	—	■	630	0.28	6.0	—	—	—	—	—	—
ADEX 160630FR-FA	HF7	3.0	—	—	—	—	—	—	—	—	■	270	0.28	6.0	—	—	—	—	—	—

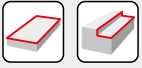

a_s DC	5 %	10 %	15 %	20 %	25 %	30 %	40 %	50 %	60 %	70 %	75 %	80 %	90 %	100 %
	1.48	1.35	1.27	1.22	1.19	1.16	1.11	1.08	1.05	1.03	1.00	1.00	1.00	1.00
	2.20	1.60	1.35	1.20	1.10	0.95	0.85	0.75	0.85	0.95	1.00	1.00	1.00	1.00
	0.64	0.64	0.64	0.64	0.64	0.65	0.65	0.67	0.68	0.71	0.72	0.74	0.79	1.00

	ADMX 16-F	ADEX 16-FM	ADMX 16-M								ADMX 16-R	
	0.8	0.8	0.4	0.8	1.6	2.0	3.0	3.2	4.0	5.0	0.8	1.6
	2.99	2.18	3.39	2.99	1.62	1.23	0.28	0.09	2.69	1.52	2.99	1.62

	ADMX 16-MF	ADMX 16-MM			ADEX 16-HF	ADEX 16-HF2	ADEX 16-FA			
	0.8	0.4	0.8	1.6	1.2	1.2	0.4	0.8	1.6	3.0
	2.99	3.39	2.99	1.62	0.52	0.52	2.84	2.44	1.65	0.69

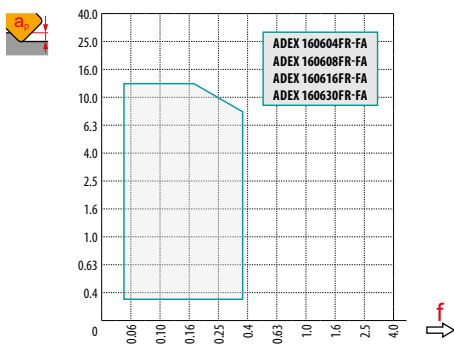
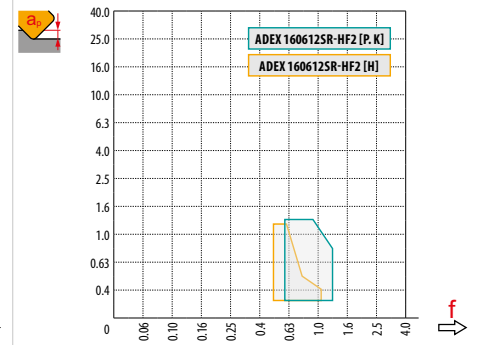
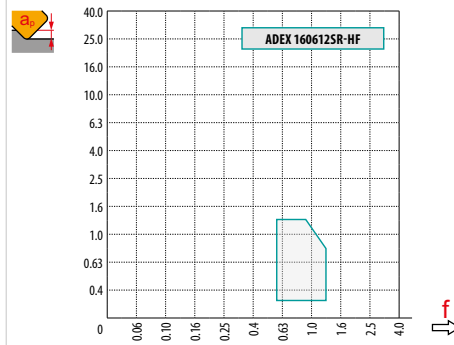
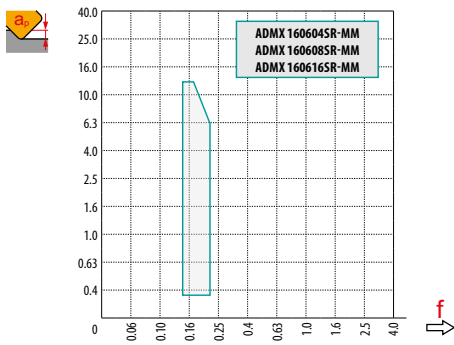
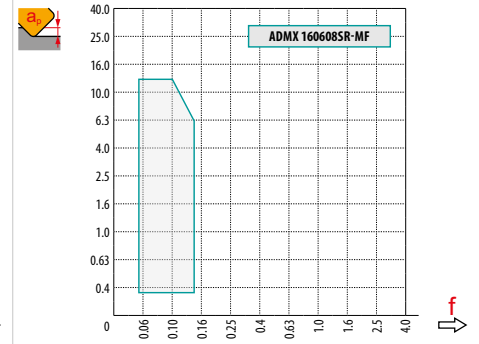
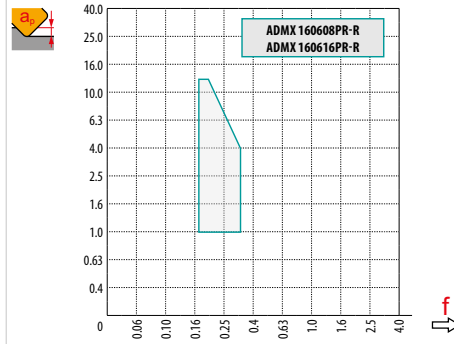
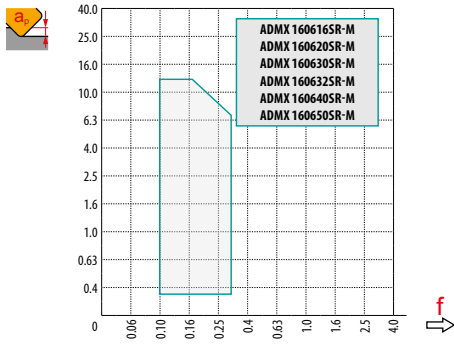
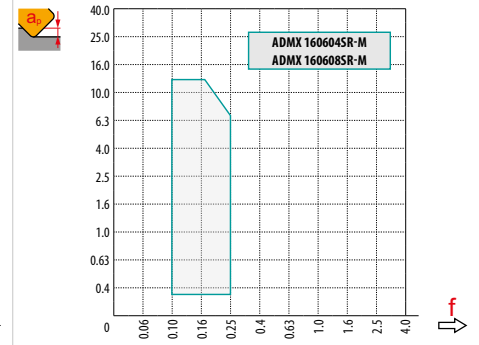
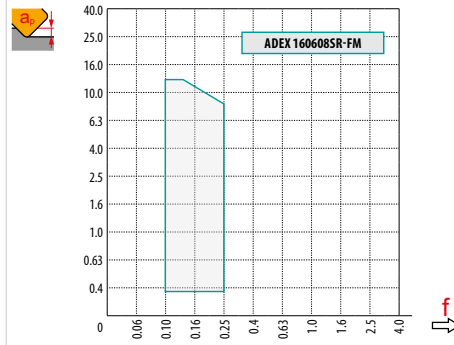
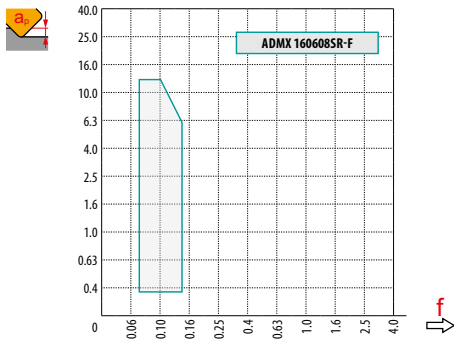

max
7.5



	1.0	6.0	13.0
	0.28	0.19	0.10



	HFC				
25	12.5	13.0/60	4.0	8.0	1.3/19
32	7.5	13.0/100	2.0	7.5	1.3/38
40	5.0	8.6/100	1.2	4.5	1.3/65
50	3.5	6.0/100	0.8	3.0	1.3/100
63	2.5	4.2/100	0.5	2.0	0.8/100
80	2.0	3.3/100	0.4	1.5	0.6/100

* HFC milling

** Conventional milling



2.5

DC	HFC							
	DMIN	DMAX	SMAX DMIN	SMAX DMAX	DMIN	DMAX	SMAX DMIN	SMAX DMAX
25	42.0	50.0	10.0	12.5	42.0	50.0	1.3	1.3
32	55.0	64.0	6.5	9.0	55.0	64.0	1.3	1.3
40	72.0	80.0	5.0	8.0	72.0	80.0	1.3	1.3
50	92.0	100.0	4.5	6.0	92.0	100.0	1.3	1.3
63	118.0	126.0	4.0	5.0	118.0	126.0	1.3	1.3
80	136.0	160.0	1.5	2.0	136.0	160.0	1.3	1.3



DC	μm	3	5	10	15	20	30	40	50	60	80	100
25		0.548	0.707	1.000	1.225	1.414	1.732	2.000	2.236	2.449	2.828	3.162
32		0.620	0.800	1.131	1.386	1.600	1.960	2.263	2.530	2.771	3.200	3.578
40		0.693	0.894	1.265	1.549	1.789	2.191	2.530	2.828	3.098	3.578	4.000
50		0.775	1.000	1.414	1.732	2.000	2.449	2.828	3.162	3.464	4.000	4.472
63		0.869	1.122	1.587	1.944	2.245	2.750	3.175	3.550	3.888	4.490	5.020
80		0.980	1.265	1.789	2.191	2.530	3.098	3.578	4.000	4.382	5.060	5.657

RE	μm	3	5	10	15	20	30	40	50	60	80	100
1.6		0.196	0.253	0.358	0.438	0.506	0.620	0.716	0.800	0.876	1.012	1.131
2.0		0.219	0.283	0.400	0.490	0.566	0.693	0.800	0.894	0.980	1.131	1.265
3.0		0.268	0.346	0.490	0.600	0.693	0.849	0.980	1.095	1.200	1.386	1.549
3.2		0.277	0.358	0.506	0.620	0.716	0.876	1.012	1.131	1.239	1.431	1.600
4.0		0.310	0.400	0.566	0.693	0.800	0.980	1.131	1.265	1.386	1.600	1.789
5.0		0.346	0.447	0.632	0.775	0.894	1.095	1.265	1.414	1.549	1.789	2.000

i

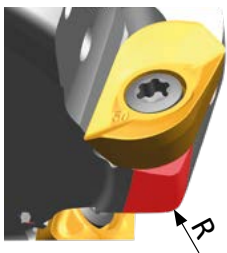

ADMX/ADEX 16	R
ADMX 160630SR-M	2.5
ADMX 160632SR-M	2.5
ADMX 160640SR-M	4.0
ADMX 160650SR-M	4.5
ADEX 160612SR-HF	3.0
ADEX 160612SR-HF2	3.0

i

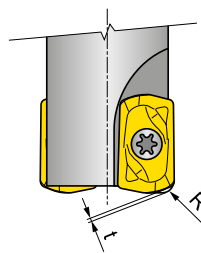

ADEX 16	R	t
ADEX 160612SR-HF	2.59	0.56
ADEX 160612SR-HF2	2.48	0.57



SAP10D

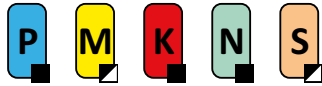

PRAMET

S



Square Shoulder Mill for APKT 10 Insert with Internal Coolant

90° end and shell mills utilising positive APKT 10 style insert with APMX of 9 mm. Suitable for face, shoulder, slot, helical, trochoidal, ramping and plunge milling. Available in weldon and arbor (with differential tooth pitch) style, in Ø10 up to Ø63 mm. Body treated for longer tool life.

KAPR	90°
APMX	9.0 mm

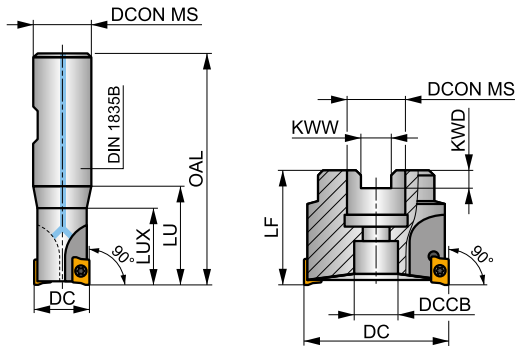
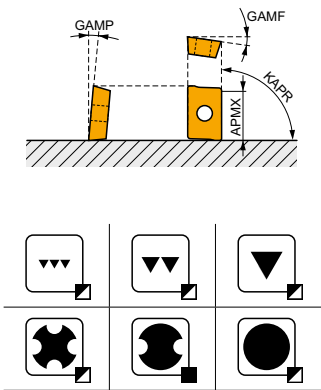

	0.08 - 0.16
	0.06 - 0.13



Product	DC	OAL	DCON MS	DCCB	LU	LUX	LF	KWW	KWD	GAMF	GAMP								
	[mm]	[mm]	[mm]	[mm]	[mm]	[mm]	[mm]	[mm]	[mm]	[°]	[°]								
10A1R020B16-SAP10D-C	10	78	16	-	30	20	-	-	-	12	2	1	-	3900	✓	0.09	GI081	SQ215	
12A1R027B16-SAP10D-C	12	75	16	-	27	-	-	-	-	12	2	1	-	35600	✓	0.10	GI081	SQ210	
14A1R027B16-SAP10D-C	14	75	16	-	27	-	-	-	-	12	2	1	-	32900	✓	0.13	GI081	SQ210	
16A2R032B16-SAP10D-C	16	80	16	-	32	-	-	-	-	12	4	2	-	30800	✓	0.12	GI081	SQ210	
18A2R032B20-SAP10D-C	18	82	20	-	32	-	-	-	-	12	4	2	-	29100	✓	0.15	GI081	SQ210	
20A3R032B20-SAP10D-C	20	82	20	-	32	-	-	-	-	12	4	3	-	27600	✓	0.15	GI081	SQ210	
25A3R042B25-SAP10D-C	25	98	25	-	42	-	-	-	-	12	4	3	-	24700	✓	0.36	GI081	SQ210	
40A6R-S90AP10D	40	40	16	14	40	-	-	8.4	5.6	8	3	6	✓	19500	-	0.23	GI081	SQ211	
50A7R-S90AP10D	50	40	22	18	40	-	-	10.4	6.3	8	3	7	✓	17400	-	0.41	GI081	SQ211	
63A9R-S90AP10D	63	50	22	18	40	-	-	10.4	6.3	8	3	9	✓	15500	-	0.57	GI081	SQ211	

	APKT 1003..
--	-------------

SQ210	US 2506-T07P	1.2	M 2.5	6.3	-	Flag T07P
SQ211	US 2506-T07P	1.2	M 2.5	6.3	D-T07P/T09P	FG-15
SQ215	US 2505-T07P	1.2	M 2.5	5.2	-	Flag T07P



APKT 10



	W1	D1	L	S
	[mm]	[mm]	[mm]	[mm]
1003	6.700	2.88	11.00	3.50

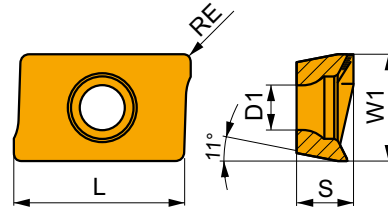

Suitability and starting values for cutting speed (vc), feed (f) and depth of cut (ap). Refer to our Machining Calculator app for further calculations.

Product	RE	P			M			K			N			S			H		
		vc	f	ap	vc	f	ap	vc	f	ap	vc	f	ap	vc	f	ap	vc	f	ap
	[mm]	[m/min]	[mm/tooth]	[mm]	[m/min]	[mm/tooth]	[mm]	[m/min]	[mm/tooth]	[mm]	[m/min]	[mm/tooth]	[mm]	[m/min]	[mm/tooth]	[mm]	[m/min]	[mm/tooth]	[mm]

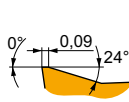

M geometry with highly positive design for light to medium machining.

APKT 1003PDER-M	8215	0.5	█	285	0.12	4.0	▣	170	0.11	4.0	█	270	0.12	4.0	█	70	0.11	3.2	█	–	–	–
	M8330	0.5	█	285	0.12	4.0	▣	170	0.11	4.0	█	270	0.12	4.0	█	70	0.11	3.2	█	–	–	–
	M8340	0.5	█	255	0.12	4.0	▣	150	0.11	4.0	█	240	0.12	4.0	█	60	0.11	3.2	█	–	–	–
	M9315	0.5	█	400	0.12	4.0	▣	–	–	–	█	380	0.12	4.0	█	–	–	–	█	–	–	–
	M9325	0.5	█	360	0.12	4.0	▣	–	–	–	█	340	0.12	4.0	█	–	–	–	█	–	–	–
	M9340	0.5	█	335	0.12	4.0	▣	200	0.11	4.0	█	–	–	–	█	80	0.11	3.2	█	–	–	–

APKT 10-FA



	W1	D1	L	S
	[mm]	[mm]	[mm]	[mm]
1003	6.700	2.88	11.00	3.50

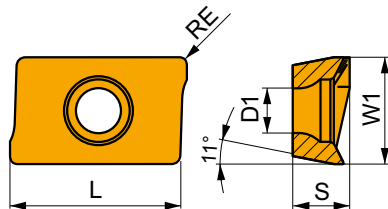

Suitability and starting values for cutting speed (vc), feed (f) and depth of cut (ap). Refer to our Machining Calculator app for further calculations.

Product	RE	P			M			K			N			S			H		
		vc	f	ap	vc	f	ap	vc	f	ap	vc	f	ap	vc	f	ap	vc	f	ap
	[mm]	[m/min]	[mm/tooth]	[mm]	[m/min]	[mm/tooth]	[mm]	[m/min]	[mm/tooth]	[mm]	[m/min]	[mm/tooth]	[mm]	[m/min]	[mm/tooth]	[mm]	[m/min]	[mm/tooth]	[mm]

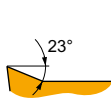

FA geometry with highly positive design for fine-finish to medium machining.

APKT 1003PDFR-FA	HF7	0.5	█	–	–	–	▣	–	–	–	█	300	0.18	5.0	█	–	–	–	█	–	–	–
-------------------------	------------	-----	---	---	---	---	---	---	---	---	---	-----	------	-----	---	---	---	---	---	---	---	---

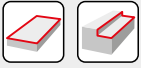

a_e / DC	5 %	10 %	15 %	20 %	25 %	30 %	40 %	50 %	60 %	70 %	75 %	80 %	90 %	100 %
X.V	1.48	1.35	1.27	1.22	1.19	1.16	1.11	1.08	1.05	1.03	1.00	1.00	1.00	1.00
x.f	2.20	1.60	1.35	1.20	1.10	0.95	0.85	0.75	0.85	0.95	1.00	1.00	1.00	1.00
x.f	0.64	0.64	0.64	0.64	0.64	0.65	0.65	0.67	0.68	0.71	0.72	0.74	0.79	1.00

	APKT 10-M	APKT 10-FA
RE	0.5	0.5
BS	0.84	0.84

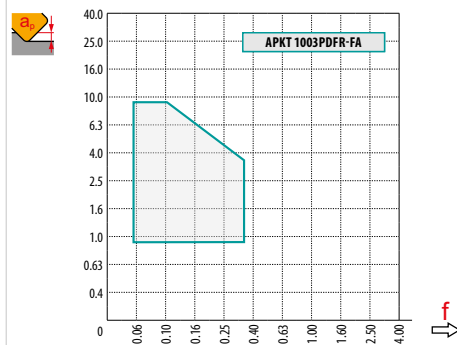
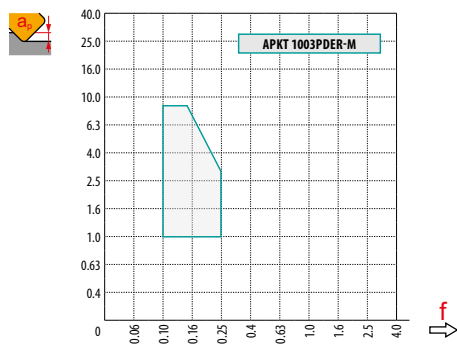

	4.5

	1.0	3.0	5.0
	0.20	0.13	0.10

DC	RPMX	APMX/I
10	7.3	9.0/72
12	6.2	9.0/84
14	5.3	9.0/99
16	2.4	4.0/100
18	2.3	3.9/100
20	2.2	3.7/100
25	2.2	3.7/100
32	1.6	2.6/100

DC	DMIN	DMAX	SMAX DMIN	SMAX DMAX
10	11.0	20.0	0.4	3.8
12	13.0	24.0	0.3	3.9
14	17.5	28.0	1.0	3.9
16	20.5	32.0	0.6	2.0
18	23.8	36.0	0.7	2.2
20	27.2	40.0	0.9	2.4
25	37.9	50.0	1.6	3.0
32	50.9	64.0	1.7	2.8

	0.3



SAP16D

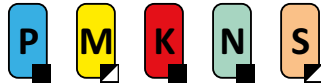

PRAMET

S



Square Shoulder Mill for APKT 16 Insert with Internal Coolant

90° end and shell mills utilising positive APKT 16 style insert with APMX of 13 mm. Suitable for face, shoulder, slot, helical, trochoidal, ramping and plunge milling. Available in Weldon and arbor (with differential tooth pitch) style, in Ø25 up to Ø160 mm. Body treated for longer tool life.

KAPR	90°
APMX	13.0 mm

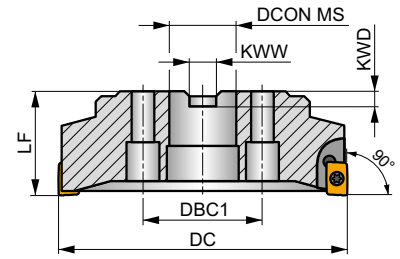
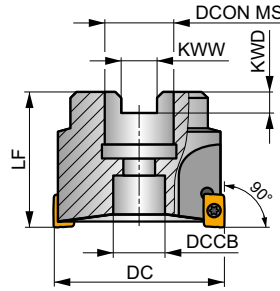
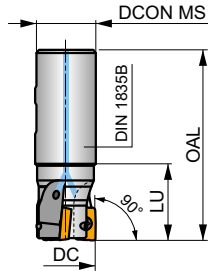
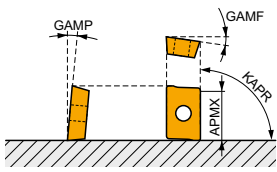

DC 40 – 125 mm

DC 160 mm

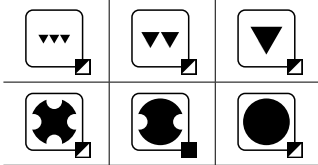

	0.10 - 0.22
	0.06 - 0.18



Product	DC	OAL	DCON MS	DCCB	DBC1	LU	LF	KWW	KWD	GAMF	GAMP					kg			
	[mm]	[mm]	[mm]	[mm]	[mm]	[mm]	[mm]	[mm]	[mm]	[°]	[°]								
25A2R042B25-SAP16D-C	25	98	25	-	-	42	-	-	-	0	6	2	-	16800	✓	0.31	GI080	SQ030	-
32A3R040B32-SAP16D-C	32	100	32	-	-	50	-	-	-	0	8	3	-	14800	✓	0.51	GI080	SQ220	-
40A3R050B32-SAP16D-C	40	110	32	-	-	50	-	-	-	0	8	3	-	13200	✓	0.65	GI080	SQ220	-
40A4R050B32-SAP16D-C	40	110	32	-	-	50	-	-	-	0	8	4	-	13200	✓	0.67	GI080	SQ220	-
40A4R-S90AP16D	40	40	16	11	-	-	40	8.4	5.6	0	6	4	✓	13200	-	0.23	GI080	SQ031	-
50A5R-S90AP16D	50	40	22	18	-	-	40	10.4	6.3	0	6	5	✓	11800	-	0.33	GI080	SQ031	-
63A6R-S90AP16D	63	40	22	18	-	-	40	10.4	6.3	0	6	6	✓	10600	-	0.50	GI080	SQ031	-
80B5R-S90AP16D	80	50	27	38	-	-	50	12.4	7	0	6	5	✓	9400	-	0.97	GI080	SQ031	AC001
80B7R-S90AP16D	80	50	27	38	-	-	50	12.4	7	0	6	7	✓	9400	-	1.07	GI080	SQ031	AC001
100B6R-S90AP16D	100	50	32	45	-	-	50	14.4	8	0	6	6	✓	8400	-	1.60	GI080	SQ031	AC002
100B8R-S90AP16D	100	50	32	45	-	-	50	14.4	8	0	6	8	✓	8400	-	1.50	GI080	SQ031	AC002
125B9R-S90AP16D	125	63	40	56	-	-	63	16.4	9	0	6	9	✓	7500	-	2.80	GI080	SQ031	AC003
160C10R-S90AP16D	160	63	40	-	66.7	-	63	16.4	9	0	6	10	✓	6600	-	5.12	GI080	SQ031	-

	GI080		APKT 1604..		APET 1604..
--	-------	--	-------------	--	-------------

SQ030	US 4008-T15P	3.5	M 4	8	-	-	Flag T15P
SQ031	US 4011-T15P	3.5	M 4	10.6	D-T08P/T15P	FG-15	-
SQ220	US 4011-T15P	3.5	M 4	10.6	-	-	Flag T15P



AC001	KS 1230	K.FMH27
AC002	KS 1635	K.FMH32
AC003	KS 2040	K.FMH40

APKT 16



	W1	D1	L	S
	[mm]	[mm]	[mm]	[mm]
1604	9.440	4.60	17.00	5.67

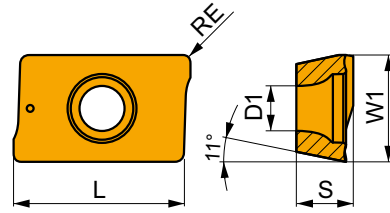

Suitability and starting values for cutting speed (vc), feed (f) and depth of cut (ap). Refer to our Machining Calculator app for further calculations.

Product	RE [mm]	P			M			K			N			S			H		
		vc	f	ap	vc	f	ap	vc	f	ap	vc	f	ap	vc	f	ap	vc	f	ap
		[m/min]	[mm/tooth]	[mm]	[m/min]	[mm/tooth]	[mm]	[m/min]	[mm/tooth]	[mm]	[m/min]	[mm/tooth]	[mm]	[m/min]	[mm/tooth]	[mm]	[m/min]	[mm/tooth]	[mm]

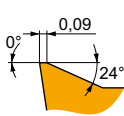

GM geometry with highly positive design for light to medium machining.

APKT 1604PDR-GM	M8330	0.8	235	0.20	8.0	140	0.18	8.0	220	0.20	8.0	55	0.16	6.4			
	M8340	0.8	210	0.20	8.0	125	0.18	8.0	195	0.20	8.0	50	0.16	6.4			
	M9315	0.8	310	0.20	8.0				290	0.20	8.0						
	M9325	0.8	285	0.20	8.0				270	0.20	8.0						
	M9340	0.8	260	0.20	8.0	155	0.18	8.0				65	0.16	6.4			

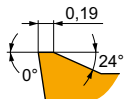

HM geometry with highly positive design for medium and less stable machining conditions.

APKT 160404-HM	M8340	0.4	160	0.30	6.0	95	0.27	6.0	150	0.30	6.0	40	0.24	4.8			
APKT 160416-HM	M8340	1.6	210	0.30	6.0	125	0.27	6.0	195	0.30	6.0	50	0.24	4.8			
APKT 160431-HM	M8340	3.1	220	0.30	6.0	130	0.27	6.0	205	0.30	6.0	55	0.24	4.8			
APKT 1604PDR-HM	8215	0.8	220	0.30	6.0	130	0.27	6.0	205	0.30	6.0	55	0.24	4.8			
	M5315	0.8	270	0.30	6.0				255	0.30	6.0						
	M8330	0.8	220	0.30	6.0	130	0.27	6.0	205	0.30	6.0	55	0.24	4.8			
	M8340	0.8	200	0.30	6.0	120	0.27	6.0	190	0.30	6.0	50	0.24	4.8			
	M9315	0.8	275	0.30	6.0				260	0.30	6.0						
M9325	0.8	260	0.30	6.0				245	0.30	6.0							



APET 16-FA

	W1	D1	L	S
	[mm]	[mm]	[mm]	[mm]
1604	9.600	4.50	17.00	4.76

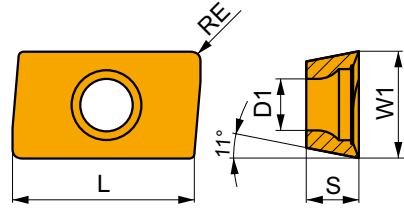

Suitability and starting values for cutting speed (vc), feed (f) and depth of cut (ap). Refer to our Machining Calculator app for further calculations.

Product	RE	P			M			K			N			S			H		
		vc	f	ap	vc	f	ap	vc	f	ap	vc	f	ap	vc	f	ap	vc	f	ap
	[mm]	[m/min]	[mm/tooth]	[mm]	[m/min]	[mm/tooth]	[mm]	[m/min]	[mm/tooth]	[mm]	[m/min]	[mm/tooth]	[mm]	[m/min]	[mm/tooth]	[mm]	[m/min]	[mm/tooth]	[mm]

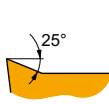

FA geometry with highly positive design for fine-finish to medium machining.

APET 160408FR-FA	HF7	0.8	-	-	-	-	-	-	-	255	0.24	8.0	-	-	-	-	-	-	-
------------------	-----	-----	---	---	---	---	---	---	---	-----	------	-----	---	---	---	---	---	---	---



a_e / DC	5 %	10 %	15 %	20 %	25 %	30 %	40 %	50 %	60 %	70 %	75 %	80 %	90 %	100 %
	1.48	1.35	1.27	1.22	1.19	1.16	1.11	1.08	1.05	1.03	1.00	1.00	1.00	1.00
	2.20	1.60	1.35	1.20	1.10	0.95	0.85	0.75	0.85	0.95	1.00	1.00	1.00	1.00
	0.64	0.64	0.64	0.64	0.64	0.65	0.65	0.67	0.68	0.71	0.72	0.74	0.79	1.00

	APKT 16-GM	APKT 16-HM				APET 16-FA
	0.8	0.8	0.4	1.6	3.1	0.8
	1.39	1.48	1.87	0.64	1.30	1.59

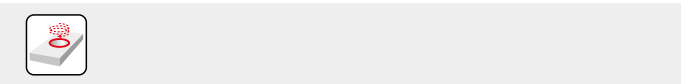
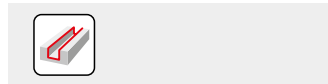
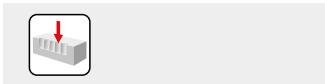
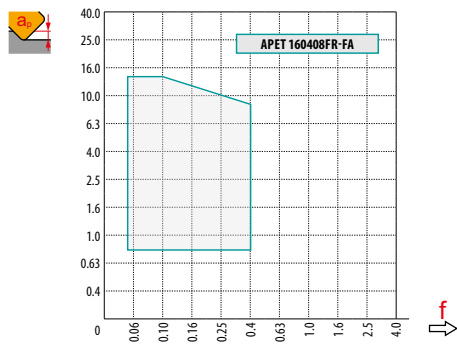
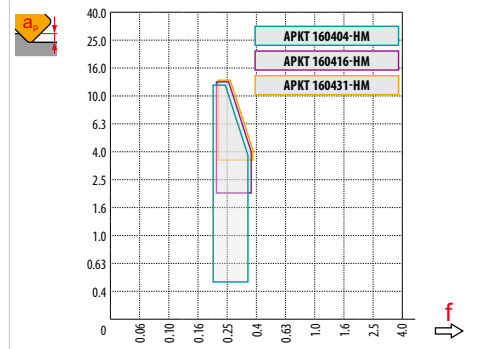
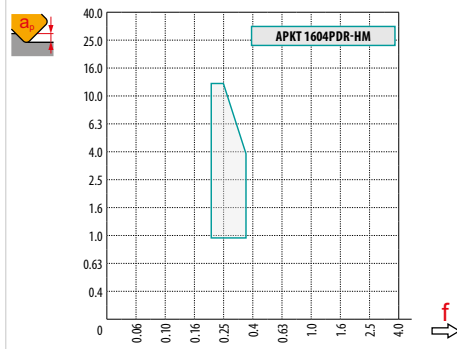
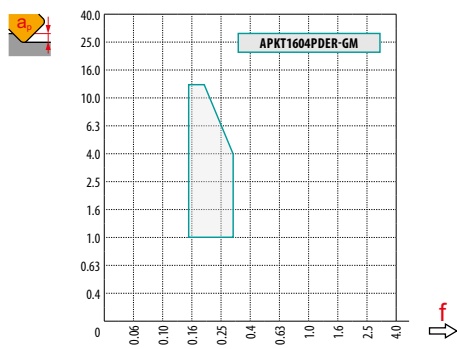

	7.4
--	-----

	1.0	6.0	13.0
	0.28	0.19	0.13

DC	DMIN	DMAX		
25	34.7	50.0	1.2	3.1
32	48.5	64.0	0.9	1.7
40	63.5	80.0	1.3	2.2
50	83.5	100.0	0.9	1.4
63	110.0	126.0	1.0	1.4
80	144.0	160.0	1.1	1.3



	RPMX	APMX/I
25	2.3	3.9/100
32	1.0	1.6/100
40	1.0	1.6/100
50	0.5	0.7/100
63	0.4	0.5/100
80	0.3	0.4/100

0.2



STN10

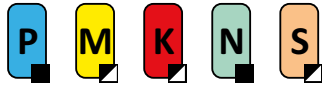

PRAMET

S



ECON TN10 Square Shoulder Mill with Internal Coolant

90° end and shell mills utilising double sided TNGX 10 insert with 6 cutting edges and APMX of 5 mm. Suitable for a wide range of applications. Available in cylindrical, weldon, modular and arbor style, in Ø18 up to Ø80 mm, with or without differential tooth pitch. Body treated for longer tool life.

ECON TN

KAPR	90°
APMX	5.0 mm

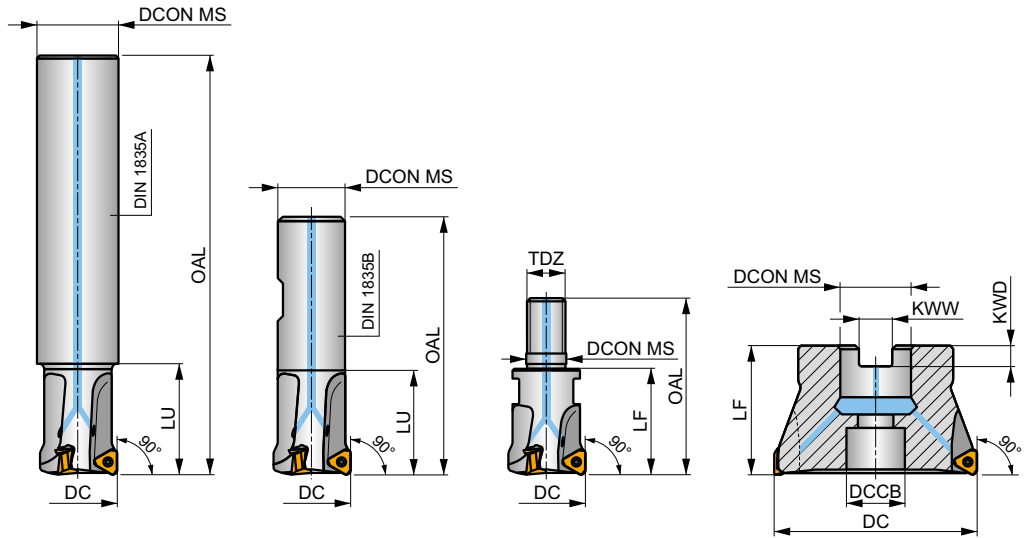
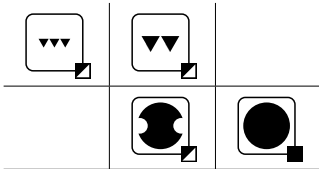
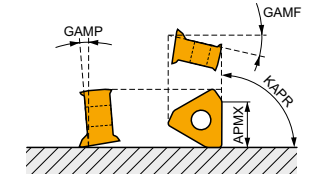

	0.03 - 0.08
	0.03 - 0.06

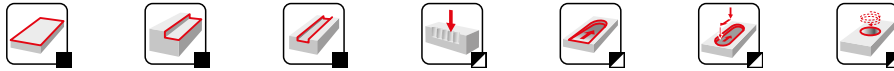

Product	DC	OAL	DCON MS	DCCB	LU	LF	TDZ	KWW	KWD	GAMF	GAMP	max.		kg	G1292	SQ300			
	[mm]	[mm]	[mm]	[mm]	[mm]	[mm]	[mm]	[mm]	[mm]	[°]	[°]								
18A2R050A20-STN10-C	18	180	20	-	50	-	-	-	-	-17.1	-11	2	-	29100	✓	0.40	GI292	SQ300	-
20A2R029A20-STN10-C	20	150	20	-	29	-	-	-	-	-16.5	-11	2	-	27600	✓	0.35	GI292	SQ300	-
20A3R029A20-STN10-C	20	150	20	-	29	-	-	-	-	-16.5	-11	3	-	27600	✓	0.34	GI292	SQ300	-
22A3R050A25-STN10-C	22	180	25	-	50	-	-	-	-	-16.5	-11	3	-	26300	✓	0.59	GI292	SQ300	-
25A3R034A25-STN10-C	25	170	25	-	34	-	-	-	-	-16	-11	3	-	24700	✓	0.58	GI292	SQ300	-
25A4R034A25-STN10-C	25	170	25	-	34	-	-	-	-	-16	-11	4	✓	24700	✓	0.59	GI292	SQ300	-
30A4R050A32-STN10-C	30	200	32	-	50	-	-	-	-	-16	-11	4	✓	22500	✓	1.07	GI292	SQ300	-
32A4R037A32-STN10-C	32	195	32	-	37	-	-	-	-	-16	-11	4	✓	21800	✓	1.09	GI292	SQ300	-
32A5R037A32-STN10-C	32	195	32	-	37	-	-	-	-	-16	-11	5	✓	21800	✓	1.09	GI292	SQ300	-
35A5R080A32-STN10-C	35	200	32	-	80	-	-	-	-	-16	-11	5	✓	20800	✓	0.08	GI292	SQ300	-
20A2R032B20-STN10-C	20	90	20	-	32	-	-	-	-	-16.5	-11	2	-	27600	✓	0.20	GI292	SQ300	-
20A3R032B20-STN10-C	20	90	20	-	32	-	-	-	-	-16.5	-11	3	-	27600	✓	0.20	GI292	SQ300	-
25A3R042B25-STN10-C	25	100	25	-	42	-	-	-	-	-16	-11	3	-	24700	✓	0.31	GI292	SQ300	-
25A4R042B25-STN10-C	25	100	25	-	42	-	-	-	-	-16	-11	4	✓	24700	✓	0.31	GI292	SQ300	-
32A4R042B32-STN10-C	32	110	32	-	42	-	-	-	-	-16	-11	4	✓	21800	✓	0.57	GI292	SQ300	-
32A5R042B32-STN10-C	32	110	32	-	42	-	-	-	-	-16	-11	5	✓	21800	✓	0.56	GI292	SQ300	-
20A2R026M10-STN10-C	20	45	10.5	-	-	26	M10	-	-	-16.5	-11	2	-	-	✓	0.07	GI292	SQ300	-
20A3R026M10-STN10-C	20	45	10.5	-	-	26	M10	-	-	-16.5	-11	3	-	-	✓	0.07	GI292	SQ300	-
25A3R033M12-STN10-C	25	55	12.5	-	-	33	M12	-	-	-16	-11	3	-	-	✓	0.10	GI292	SQ300	-
25A4R033M12-STN10-C	25	55	12.5	-	-	33	M12	-	-	-16	-11	4	✓	-	✓	0.11	GI292	SQ300	-
32A4R043M16-STN10-C	32	66	17	-	-	43	M16	-	-	-16	-11	4	✓	-	✓	0.22	GI292	SQ300	-
32A5R043M16-STN10-C	32	66	17	-	-	43	M16	-	-	-16	-11	5	✓	-	✓	0.22	GI292	SQ300	-
40A04R-S90TN10-C	40	-	16	14	-	40	-	8.4	5.6	-15	-11	4	✓	19500	✓	0.35	GI292	SQ302	-
40A06R-S90TN10-C	40	-	16	14	-	40	-	8.4	5.6	-15	-11	6	✓	19500	✓	0.34	GI292	SQ302	-
50A05R-S90TN10-C	50	-	22	18	-	40	-	10.4	6.3	-15	-11	5	✓	17400	✓	0.49	GI292	SQ303	-
50A07R-S90TN10-C	50	-	22	18	-	40	-	10.4	6.3	-15	-11	7	✓	17400	✓	0.50	GI292	SQ303	-
63A06R-S90TN10-C	63	-	22	18	-	40	-	10.4	6.3	-15	-11	6	✓	15500	✓	0.63	GI292	SQ303	-



Product	DC	OAL	D CONIMS	DCCB	LU	LF	TDZ	KWW	KWD	GAMF	GAMP	max.		kg	Icons		
	[mm]	[mm]	[mm]	[mm]	[mm]	[mm]	[mm]	[mm]	[mm]	[°]	[°]						
63A09R-S90TN10-C 80A10R-S90TN10-C	63	-	22	18	-	40	-	10.4	6.3	-15	-11	9	✓	15500	✓	0.64	GI292 SQ303 -
	80	-	27	38	-	50	-	12.4	7	-15	-11	10	✓	13800	✓	1.11	GI292 SQ301 AC001

		TNGX 1004..
--	--	--------------------

Icon	Icon	Nm	Icon	Icon	Icon	Icon	Icon	Icon
SQ300	US 52506-T07P	0.8	M 2.5	6	-	-	Flag T07P	-
SQ301	US 52506-T07P	0.8	M 2.5	6	D-T07P/T09P	FG-15	-	-
SQ302	US 52506-T07P	0.8	M 2.5	6	D-T07P/T09P	FG-15	-	HS 0830C
SQ303	US 52506-T07P	0.8	M 2.5	6	D-T07P/T09P	FG-15	-	HS 1030C

AC001	KS 1230	K.FMH27

TNGX 10



Icon	IC	D1	L	S
	[mm]	[mm]	[mm]	[mm]
1004	6.000	2.80	10.39	4.69

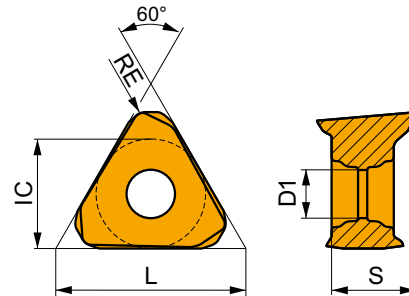

Suitability and starting values for cutting speed (vc), feed (f) and depth of cut (ap). Refer to our Machining Calculator app for further calculations.

Product	RE	P			M			K			N			S			H		
		vc	f	ap	vc	f	ap	vc	f	ap	vc	f	ap	vc	f	ap	vc	f	ap
	[mm]	[m/min]	[mm/tooth]	[mm]	[m/min]	[mm/tooth]	[mm]	[m/min]	[mm/tooth]	[mm]	[m/min]	[mm/tooth]	[mm]	[m/min]	[mm/tooth]	[mm]	[m/min]	[mm/tooth]	[mm]

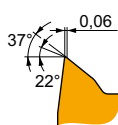









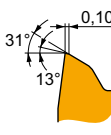



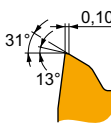

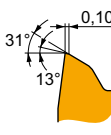

F geometry with highly positive design for light machining.

TNGX 100402SR-F	M8330	0.2	205	0.09	2.0	120	0.08	2.0	190	0.09	2.0	-	-	-	-	-	-	-	-
	M8340	0.2	190	0.09	2.0	110	0.08	2.0	180	0.09	2.0	-	-	-	-	-	-	-	-
TNGX 100404SR-F	8215	0.4	225	0.09	2.0	135	0.08	2.0	210	0.09	2.0	-	-	-	-	-	-	-	-
	M6330	0.4	190	0.09	2.0	135	0.08	2.0	-	-	-	-	-	-	-	-	-	-	-
	M8330	0.4	220	0.09	2.0	130	0.08	2.0	205	0.09	2.0	-	-	-	-	-	-	-	-
	M8340	0.4	200	0.09	2.0	120	0.08	2.0	190	0.09	2.0	-	-	-	-	-	-	-	-
TNGX 100408SR-F	M9340	0.4	270	0.09	2.0	160	0.08	2.0	-	-	-	-	-	-	-	-	-	-	-
	8215	0.8	270	0.09	2.0	160	0.08	2.0	255	0.09	2.0	-	-	-	-	-	-	-	-
	M6330	0.8	225	0.09	2.0	160	0.08	2.0	-	-	-	-	-	-	-	-	-	-	-
	M8330	0.8	260	0.09	2.0	155	0.08	2.0	245	0.09	2.0	-	-	-	-	-	-	-	-
	M8340	0.8	240	0.09	2.0	140	0.08	2.0	225	0.09	2.0	-	-	-	-	-	-	-	-
M9340	0.8	320	0.09	2.0	190	0.08	2.0	-	-	-	-	-	-	-	-	-	-	-	-

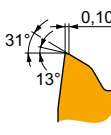

Suitability and starting values for cutting speed (vc), feed (f) and depth of cut (ap). Refer to our Machining Calculator app for further calculations.

Product	RE [mm]	P			M			K			N			S			H									
		vc [m/min]	f [mm/tooth]	ap [mm]	vc [m/min]	f [mm/tooth]	ap [mm]	vc [m/min]	f [mm/tooth]	ap [mm]	vc [m/min]	f [mm/tooth]	ap [mm]	vc [m/min]	f [mm/tooth]	ap [mm]	vc [m/min]	f [mm/tooth]	ap [mm]							
	0.4	0.10					M geometry with positive design for light to medium machining.																			
							8215	205	0.13	2.0	120	0.12	2.0	190	0.13	2.0	–	–	–	50	0.09	1.6	–	–	–	
							M6330	175	0.13	2.0	125	0.12	2.0	–	–	–	–	–	–	50	0.09	1.6	–	–	–	
							M8330	205	0.13	2.0	120	0.12	2.0	190	0.13	2.0	–	–	–	50	0.09	1.6	–	–	–	
							M8340	185	0.13	2.0	110	0.12	2.0	175	0.13	2.0	–	–	–	45	0.09	1.6	–	–	–	
							M8345	150	0.13	2.0	90	0.12	2.0	–	–	–	–	–	–	35	0.09	1.6	–	–	–	
TNGX 100408SR-M	0.4	0.8	0.10					M geometry with positive design for light to medium machining.																		
								8215	245	0.13	2.0	145	0.12	2.0	230	0.13	2.0	–	–	–	60	0.09	1.6	–	–	–
								M6330	210	0.13	2.0	150	0.12	2.0	–	–	–	–	–	–	60	0.09	1.6	–	–	–
								M8310	270	0.13	2.0	135	0.12	2.0	255	0.13	2.0	–	–	–	–	–	–	–	–	–
								M8330	245	0.13	2.0	145	0.12	2.0	230	0.13	2.0	–	–	–	60	0.09	1.6	–	–	–
								M8340	220	0.13	2.0	130	0.12	2.0	205	0.13	2.0	–	–	–	55	0.09	1.6	–	–	–
TNGX 100412SR-M	1.2	0.8	0.10					M geometry with positive design for light to medium machining.																		
								M8330	255	0.13	2.0	150	0.12	2.0	240	0.13	2.0	–	–	–	60	0.09	1.6	–	–	–
TNGX 100416SR-M	1.6	0.8	0.10					M geometry with positive design for light to medium machining.																		
								M8310	300	0.13	2.0	150	0.12	2.0	285	0.13	2.0	–	–	–	–	–	–	–	–	





TNGX 10-FA

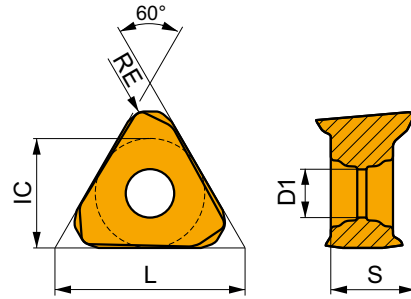

	IC [mm]	D1 [mm]	L [mm]	S [mm]
1004	6.000	2.80	10.39	4.69

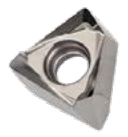
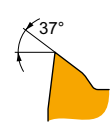

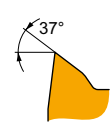
Suitability and starting values for cutting speed (vc), feed (f) and depth of cut (ap). Refer to our Machining Calculator app for further calculations.

Product	RE [mm]	P			M			K			N			S			H					
		vc [m/min]	f [mm/tooth]	ap [mm]	vc [m/min]	f [mm/tooth]	ap [mm]	vc [m/min]	f [mm/tooth]	ap [mm]	vc [m/min]	f [mm/tooth]	ap [mm]	vc [m/min]	f [mm/tooth]	ap [mm]	vc [m/min]	f [mm/tooth]	ap [mm]			
	0.4	0.10			FA geometry with highly positive design for fine-finish to medium machining.																	
					HF7	–	–	–	–	–	–	–	–	–	–	–	–	–	–	–	–	–
TNGX 100408FR-FA	0.8	0.10			FA geometry with highly positive design for fine-finish to medium machining.																	
					HF7	–	–	–	–	–	–	–	–	–	–	–	–	–	–	–	–	–

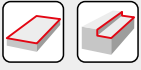

a_s / DC	5%	10%	15%	20%	25%	30%	40%	50%	60%	70%	75%	80%	90%	100%
	1.48	1.35	1.27	1.22	1.19	1.16	1.11	1.08	1.05	1.03	1.00	1.00	1.00	1.00
	2.20	1.60	1.35	1.20	1.10	0.95	0.85	0.75	0.85	0.95	1.00	1.00	1.00	1.00
	0.64	0.64	0.64	0.64	0.64	0.65	0.65	0.67	0.68	0.71	0.72	0.74	0.79	1.00

	TNGX 10-F	TNGX 10-M	TNGX 10-FA
	0.2	0.4	0.8
	1.53	1.34	0.92

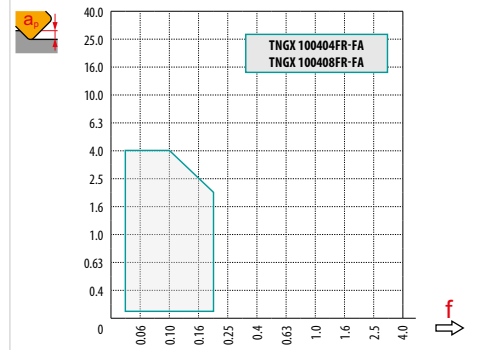
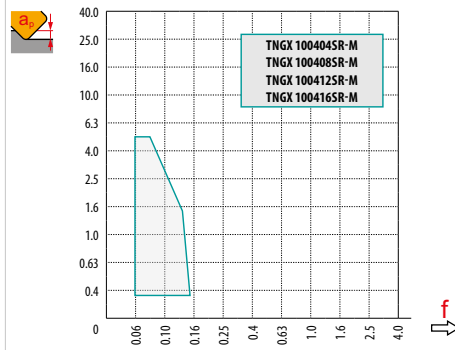
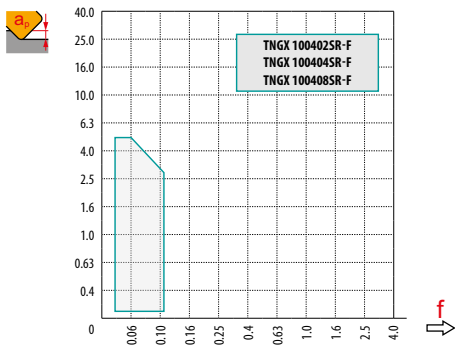

1.5

	1.0	3.0	5.0
	0.10	0.08	0.04

0.2

DC	RPMX	APMX/I
18	1.80	3.05/100
20	1.60	2.70/100
22	1.20	2.00/100
25	1.00	1.70/100
30	0.90	1.45/100
32	0.80	1.30/100
35	0.65	1.0/100
40	0.60	0.90/100
50	0.50	0.70/100
63	0.40	0.50/100
80	0.25	0.30/100

DC	DMIN	DMAX	SMAX DMIN	SMAX DMAX
18	33	36	1.2	1.2
20	37	40	1.2	1.2
22	41	44	1.0	1.0
25	47	50	1.0	1.0
30	57	60	1.0	1.0
32	61	64	1.0	1.0
35	67	70	0.9	0.9
40	77	80	0.9	0.9
50	97	100	0.9	0.9
63	123	126	0.9	0.9
80	157	160	0.9	0.9



STN16

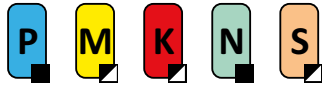

PRAMET

S



ECON TN16 Square Shoulder Mill with Internal Coolant

90° end and shell mills utilising double sided TNGX 16 inserts with 6 cutting edges and APMX of 10 mm. Suitable for a wide range of applications. Available in cylindrical, weldon, modular and arbor (with differential tooth pitch) style, in Ø25 up to Ø175 mm. Body treated for longer tool life.

ECON TN

KAPR	90°
APMX	10.0 mm

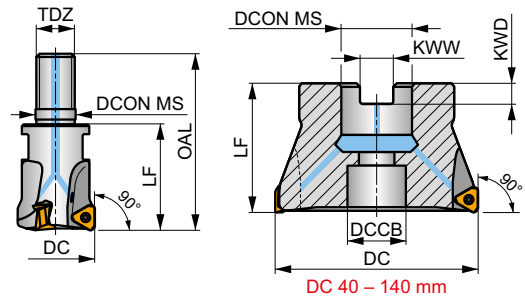
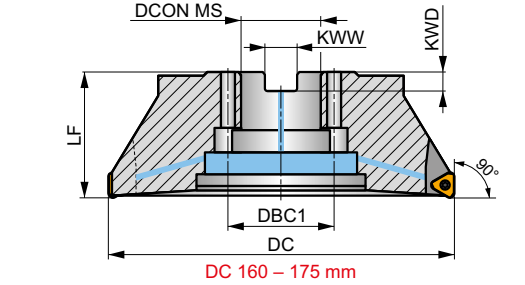
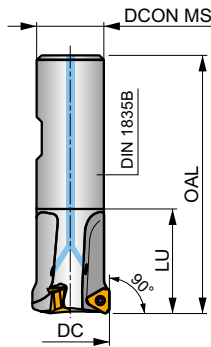
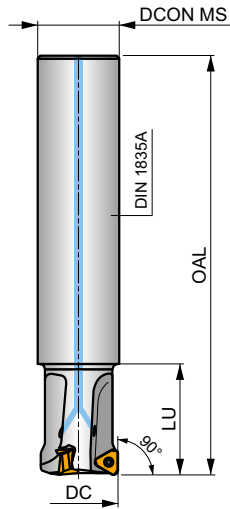
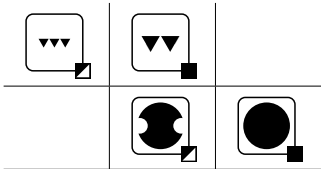
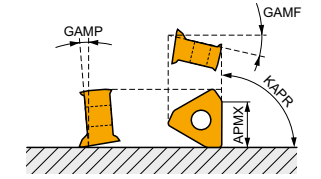

	0.03 - 0.15
	0.03 - 0.13



Product	DC	OAL	DCON MS	DCCB	DBC1	LU	LF	TDZ	KWW	KWD	GAMP	GAMP				kg			
	[mm]	[mm]	[mm]	[mm]	[mm]	[mm]	[mm]	[mm]	[mm]	[mm]	[°]	[°]	max.	kg	ISO				
25A2R034A25-STN16-C	25	170	25	-	-	34	-	-	-	-	-18.5	-9.5	2	-	20000	✓	0.54	G1340	C0382
32A2R034A32-STN16-C	32	195	32	-	-	34	-	-	-	-	-16	-9.5	2	-	17500	✓	1.05	G1340	C0382
25A2R080A25-STN16-C	25	170	25	-	-	80	-	-	-	-	-18.5	-9.5	2	-	20000	✓	0.48	G1340	C0382
32A2R080A32-STN16-C	32	195	32	-	-	80	-	-	-	-	-16	-9.5	2	-	17500	✓	0.96	G1340	C0382
32A3R034A32-STN16-C	32	195	32	-	-	34	-	-	-	-	-16	-9.5	3	-	17500	✓	1.04	G1340	C0382
35A3R034A32-STN16-C	35	195	32	-	-	34	-	-	-	-	-16	-9.5	3	-	17000	✓	1.07	G1340	C0382
25A2R042B25-STN16-C	25	55	25	-	-	42	-	-	-	-	-18.5	-9.5	2	-	20000	✓	0.30	G1340	C0382
32A3R042B32-STN16-C	32	110	32	-	-	42	-	-	-	-	-16	-9.5	3	-	17500	✓	0.52	G1340	C0382
40A4R050B32-STN16-C	40	120	32	-	-	50	-	-	-	-	-16	-9.5	4	-	16000	✓	0.67	G1340	C0382
25A2R033M12-STN16-C	25	55	12.5	-	-	-	33	M12	-	-	-18.5	-9.5	2	-	20000	✓	0.08	G1340	C0382
32A2R043M16-STN16-C	32	66	17	-	-	-	43	M16	-	-	-16	-9.5	2	-	17500	✓	0.18	G1340	C0382
32A3R043M16-STN16-C	32	66	17	-	-	-	43	M16	-	-	-16	-9.5	3	-	17500	✓	0.17	G1340	C0382
40A3R043M16-STN16-C	40	66	17	-	-	-	43	M16	-	-	-16	-9.5	3	-	16000	✓	0.20	G1340	C0382
40A4R043M16-STN16-C	40	66	17	-	-	-	43	M16	-	-	-16	-9.5	4	-	16000	✓	0.21	G1340	C0382
40A03R-S90TN16-C	40	40	16	12.4	-	-	40	-	8.4	5.6	-16	-9.5	3	-	16000	✓	0.20	G1340	C0384
40A04R-S90TN16-C	40	40	16	12.4	-	-	40	-	8.4	5.6	-16	-9.5	4	-	16000	✓	0.20	G1340	C0384
50A04R-S90TN16-C	50	40	22	18.1	-	-	40	-	10.4	6.3	-16	-9.5	4	✓	14000	✓	0.34	G1340	C0386
50A05R-S90TN16-C	50	40	22	18.1	-	-	40	-	10.4	6.3	-16	-9.5	5	✓	14000	✓	0.32	G1340	C0386
63A04R-S90TN16-C	63	40	22	18.1	-	-	40	-	10.4	6.3	-16	-9.5	4	✓	12500	✓	0.47	G1340	C0386
63A06R-S90TN16-C	63	40	22	18.1	-	-	40	-	10.4	6.3	-16	-9.5	6	✓	12500	✓	0.48	G1340	C0386
80A05R-S90TN16-C	80	50	27	22.1	-	-	50	-	12.4	7	-16	-9.5	5	✓	11000	✓	1.02	G1340	C0388
80A07R-S90TN16-C	80	50	27	22.1	-	-	50	-	12.4	7	-16	-9.5	7	✓	11000	✓	1.05	G1340	C0388
100A06R-S90TN16-C	100	50	32	45.1	-	-	50	-	14.4	8	-16	-9.5	6	✓	10000	✓	1.79	G1340	C0390
100A08R-S90TN16-C	100	50	32	45.1	-	-	50	-	14.4	8	-16	-9.5	8	✓	10000	✓	1.66	G1340	C0390
115A06R-S90TN16-C	115	50	32	45.1	-	-	50	-	14.4	8	-16	-9.5	6	✓	9500	✓	2.04	G1340	C0390
125A07R-S90TN16-C	125	63	40	56.1	-	-	63	-	16.4	9	-16	-9.5	7	✓	9000	✓	3.05	G1340	C0390
125A09R-S90TN16-C	125	63	40	56.1	-	-	63	-	16.4	9	-16	-9.5	9	✓	9000	✓	3.14	G1340	C0390



Product	DC	OAL	DCONMS	DCCB	DBC1	LU	LF	TDZ	KWW	KWD	GAMF	GAMP	max.		kg	G1340	C0394	
	[mm]	[mm]	[mm]	[mm]	[mm]	[mm]	[mm]	[mm]	[mm]	[mm]	[°]	[°]						
140A08R-S90TN16-C	140	63	40	56.1	-	-	63	-	16.4	9	-16	-9.5	8	✓	8500	✓	3.69	G1340 C0394
160C10R-S90TN16-C	160	63	40	-	66.7	-	63	-	16.4	9.2	-16	-9.5	10	✓	8000	✓	5.16	G1340 C0394
175C10R-S90TN16-C	175	63	40	-	66.7	-	63	-	16.4	9.2	-16	-9.5	10	✓	7500	✓	5.99	G1340 C0394

	TNGX1606..
--	------------

C0382	US 44010-T15P	3.5	M 4	10	-	-	Flag T15P	-	-	-
C0384	US 44010-T15P	3.5	M 4	10	D-T08P/T15P	FG-15	-	HS 90835	-	-
C0386	US 44010-T15P	3.5	M 4	10	D-T08P/T15P	FG-15	-	HS 1030C	-	-
C0388	US 44010-T15P	3.5	M 4	10	D-T08P/T15P	FG-15	-	HS 1230C	-	-
C0390	US 44010-T15P	3.5	M 4	10	D-T08P/T15P	FG-15	-	-	-	-
C0394	US 44010-T15P	3.5	M 4	10	D-T08P/T15P	FG-15	-	HS 1240C	HSD 0825C	CAC 160C

TNGX 16



	IC	D1	L	S
	[mm]	[mm]	[mm]	[mm]
1606	9.525	4.40	16.50	6.58

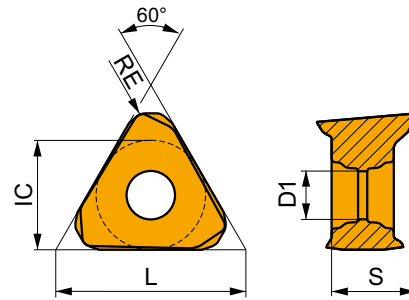

Suitability and starting values for cutting speed (vc), feed (f) and depth of cut (ap). Refer to our Machining Calculator app for further calculations.

Product	RE	P			M			K			N			S			H		
		vc	f	ap	vc	f	ap	vc	f	ap	vc	f	ap	vc	f	ap	vc	f	ap
	[mm]	[m/min]	[mm/tooth]	[mm]	[m/min]	[mm/tooth]	[mm]	[m/min]	[mm/tooth]	[mm]	[m/min]	[mm/tooth]	[mm]	[m/min]	[mm/tooth]	[mm]	[m/min]	[mm/tooth]	[mm]

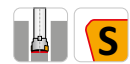
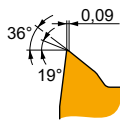
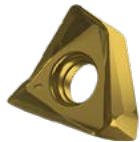

F geometry with highly positive design for light machining.

TNGX 160604SR-F	M8330	0.4	■	205	0.10	3.0	■	120	0.09	3.0	■	190	0.10	3.0	-	-	-	-	-	-
	M8340	0.4	■	190	0.10	3.0	■	110	0.09	3.0	■	180	0.10	3.0	-	-	-	-	-	-
TNGX 160608SR-F	8215	0.8	■	250	0.10	3.0	■	150	0.09	3.0	■	235	0.10	3.0	-	-	-	-	-	-
	M6330	0.8	■	215	0.10	3.0	■	150	0.09	3.0	-	-	-	-	-	-	-	-	-	-
	M8310	0.8	■	280	0.10	3.0	■	140	0.09	3.0	■	265	0.10	3.0	-	-	-	-	-	-
	M8330	0.8	■	245	0.10	3.0	■	145	0.09	3.0	■	230	0.10	3.0	-	-	-	-	-	-
	M8340	0.8	■	225	0.10	3.0	■	135	0.09	3.0	■	210	0.10	3.0	-	-	-	-	-	-

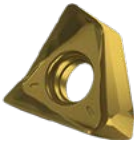
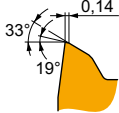

Suitability and starting values for cutting speed (vc), feed (f) and depth of cut (ap). Refer to our Machining Calculator app for further calculations.

Product	RE [mm]	P			M			K			N			S			H				
		vc [m/min]	f [mm/tooth]	ap [mm]	vc [m/min]	f [mm/tooth]	ap [mm]	vc [m/min]	f [mm/tooth]	ap [mm]	vc [m/min]	f [mm/tooth]	ap [mm]	vc [m/min]	f [mm/tooth]	ap [mm]	vc [m/min]	f [mm/tooth]	ap [mm]		
  M geometry with positive design for light to medium machining.																					
	TNGX 160604SR-M	8215	0.4	190	0.15	3.0	110	0.14	3.0	180	0.15	3.0	—	—	—	45	0.11	2.4	—	—	—
		M6330	0.4	165	0.15	3.0	115	0.14	3.0	—	—	—	—	—	—	45	0.11	2.4	—	—	—
		M8310	0.4	205	0.15	3.0	100	0.14	3.0	190	0.15	3.0	—	—	—	—	—	—	—	—	—
		M8330	0.4	190	0.15	3.0	110	0.14	3.0	180	0.15	3.0	—	—	—	45	0.11	2.4	—	—	—
TNGX 160608SR-M	M8340	0.4	170	0.15	3.0	100	0.14	3.0	160	0.15	3.0	—	—	—	40	0.11	2.4	—	—	—	
	8215	0.8	230	0.15	3.0	135	0.14	3.0	215	0.15	3.0	—	—	—	55	0.11	2.4	—	—	—	
	M6330	0.8	195	0.15	3.0	135	0.14	3.0	—	—	—	—	—	—	55	0.11	2.4	—	—	—	
	M8310	0.8	245	0.15	3.0	120	0.14	3.0	230	0.15	3.0	—	—	—	—	—	—	—	—	—	
	M8330	0.8	225	0.15	3.0	135	0.14	3.0	210	0.15	3.0	—	—	—	55	0.11	2.4	—	—	—	
	M8340	0.8	205	0.15	3.0	120	0.14	3.0	190	0.15	3.0	—	—	—	50	0.11	2.4	—	—	—	
TNGX 160612SR-M	M8345	0.8	160	0.15	3.0	95	0.14	3.0	—	—	—	—	—	—	40	0.11	2.4	—	—	—	
	M9325	0.8	285	0.15	3.0	—	—	—	270	0.15	3.0	—	—	—	—	—	—	—	—	—	
	M9340	0.8	260	0.15	3.0	155	0.14	3.0	—	—	—	—	—	—	65	0.11	2.4	—	—	—	
	M8330	1.2	235	0.15	3.0	140	0.14	3.0	220	0.15	3.0	—	—	—	55	0.11	2.4	—	—	—	
	M8340	1.2	215	0.15	3.0	125	0.14	3.0	200	0.15	3.0	—	—	—	50	0.11	2.4	—	—	—	
TNGX 160616SR-M	M8310	1.6	275	0.15	3.0	140	0.14	3.0	260	0.15	3.0	—	—	—	—	—	—	—	—	—	
	M8330	1.6	250	0.15	3.0	150	0.14	3.0	235	0.15	3.0	—	—	—	60	0.11	2.4	—	—	—	
	M8340	1.6	225	0.15	3.0	135	0.14	3.0	210	0.15	3.0	—	—	—	55	0.11	2.4	—	—	—	

TNGX 16-FA



	IC [mm]	D1 [mm]	L [mm]	S [mm]
1606	9.525	4.40	16.50	6.58

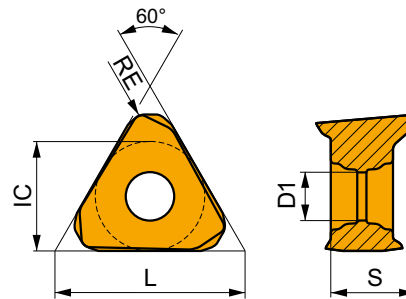

Suitability and starting values for cutting speed (vc), feed (f) and depth of cut (ap). Refer to our Machining Calculator app for further calculations.

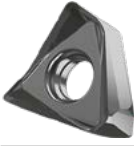
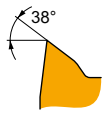
Product	RE	P			M			K			N			S			H				
		vc [m/min]	f [mm/tooth]	ap [mm]	vc [m/min]	f [mm/tooth]	ap [mm]	vc [m/min]	f [mm/tooth]	ap [mm]	vc [m/min]	f [mm/tooth]	ap [mm]	vc [m/min]	f [mm/tooth]	ap [mm]	vc [m/min]	f [mm/tooth]	ap [mm]		
  FA geometry with highly positive design for fine-finish to medium machining.																					
	TNGX 160604FR-FA	HF7	0.4	—	—	—	—	—	—	—	—	—	255	0.14	2.0	—	—	—	—	—	—
	M0315	0.4	—	—	—	—	—	—	—	—	—	—	585	0.14	2.0	—	—	—	—	—	—
TNGX 160608FR-FA	HF7	0.8	—	—	—	—	—	—	—	—	—	—	300	0.14	2.0	—	—	—	—	—	—
	M0315	0.8	—	—	—	—	—	—	—	—	—	—	690	0.14	2.0	—	—	—	—	—	—

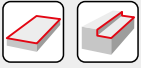

a_s DC	5 %	10 %	15 %	20 %	25 %	30 %	40 %	50 %	60 %	70 %	75 %	80 %	90 %	100 %
	1.48	1.35	1.27	1.22	1.19	1.16	1.11	1.08	1.05	1.03	1.00	1.00	1.00	1.00
	2.20	1.60	1.35	1.20	1.10	0.95	0.85	0.75	0.85	0.95	1.00	1.00	1.00	1.00
	0.64	0.64	0.64	0.64	0.64	0.65	0.65	0.67	0.68	0.71	0.72	0.74	0.79	1.00

	TNGX 16-F		TNGX 16-M				TNGX 16-FA	
	0.4	0.8	0.4	0.8	1.2	1.6	0.4	0.8
	2.10	1.9	2.10	1.90	1.73	1.14	2.10	1.90

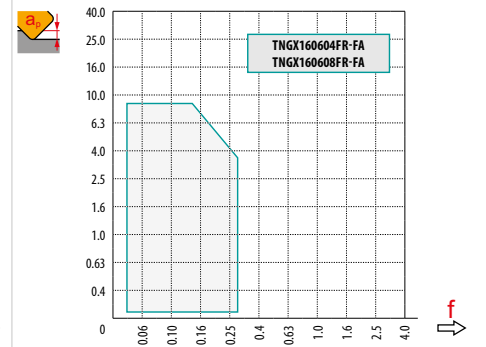
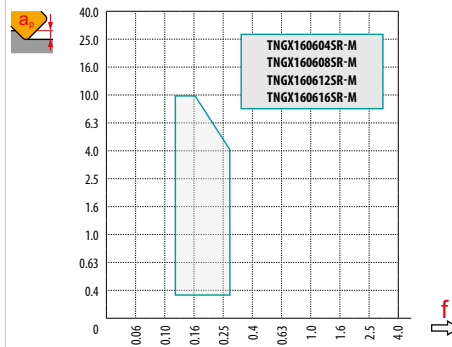
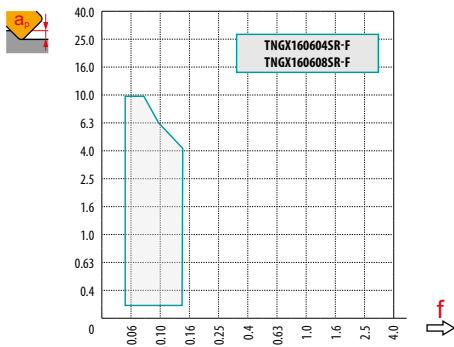

	3.0	4.5	6.0
	0.18	0.14	0.10



DC		$d_{min} = DC^*$			$d = 1.25 DC$			$d = 1.5 DC$			$d = 1.75 DC$			$d \geq 2 DC$	
		SMAX	$a_{e max}$		SMAX	$a_{e max}$		SMAX	$a_{e max}$		SMAX	$a_{e max}$		SMAX	$a_{e max}$
25	25	0.14	1.3	31	0.22	2.2	38	0.33	3.0	44	0.60	4.0	50	0.70	5.0
32	32	0.16	1.5	40	0.33	2.8	48	0.44	4.0	56	0.70	5.0	64	0.90	6.5
40	40	0.22	2.0	50	0.38	3.5	60	0.55	5.0	70	0.90	6.5	80	1.15	8.0
50	50	0.27	2.5	63	0.50	4.5	75	0.70	6.5	88	1.00	8.0	100	1.40	10.0
63	63	0.33	3.2	80	0.60	5.5	95	0.90	8.0	110	1.45	10.0	125	1.80	12.5
80	80	0.55	4.0	100	1.00	7.0	120	1.45	10.0	140	2.15	13.0	160	2.60	16.0
100	100	0.70	5.0	125	1.20	9.0	150	1.80	12.5	175	2.70	16.5	200	3.30	20.0
115	115	0.85	6.0	145	1.50	10.0	175	1.90	14.5	200	2.80	19.0	230	3.80	23.0
125	125	0.90	6.5	155	1.60	11.0	190	2.30	15.5	220	3.10	20.0	250	4.10	25.0
140	140	1.00	7.0	175	1.80	12.5	210	2.60	17.5	245	3.70	23.0	280	4.60	28.0
160	160	1.20	8.0	200	2.00	14.0	240	2.90	20.0	280	4.30	26.0	320	5.30	32.0
175	175	1.30	8.8	220	2.20	15.5	265	3.20	22.0	305	4.70	29.0	350	5.80	35.0

* Check feed rate reduction when hole diameter is between $d_{min} - 1.5 DC$.

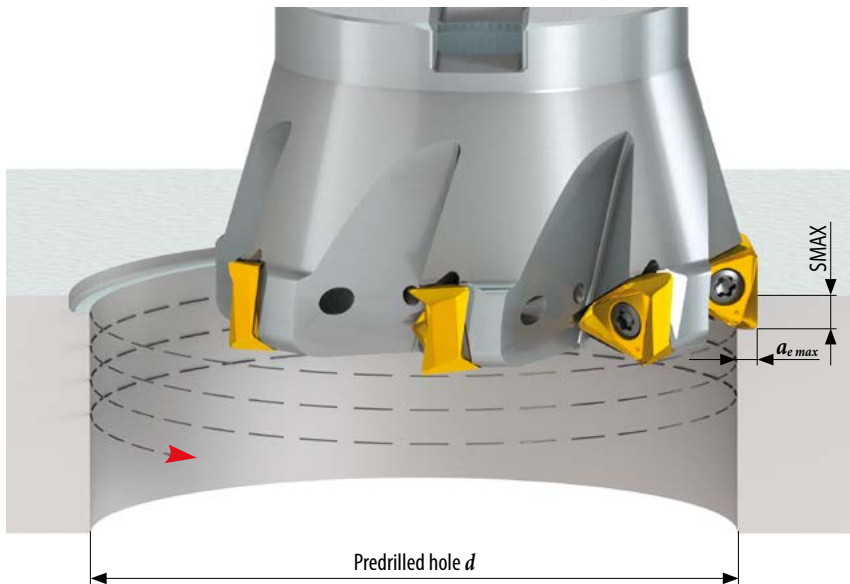



SLN12



PRAMET

S



ECON LN12 Square Shoulder Mill with Internal Coolant

90° end and shell mills utilising double sided LN.. 12 inserts with APMX of 9 mm. Suitable for a wide range of applications. Available in cylindrical, Weldon, modular and arbor (with differential tooth pitch) style, in Ø25 up to Ø125 mm. Body treated for longer tool life.

ECON LN

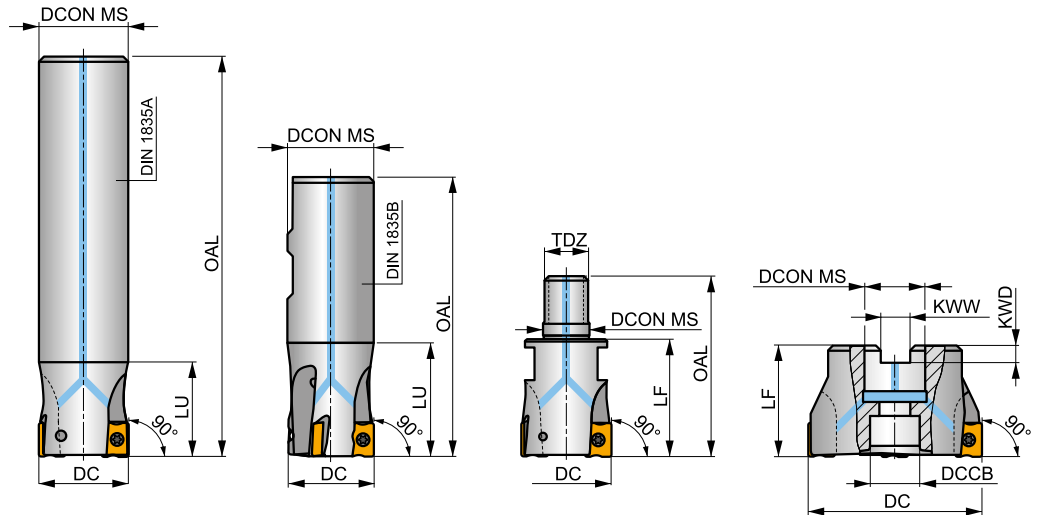

KAPR	90°
APMX	9.0 mm

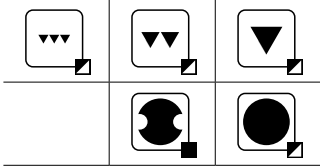
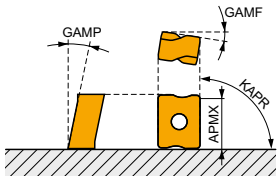

	0.06 - 0.15
	0.06 - 0.13



Product	DC	OAL	DCON MS	DCCB	LU	LF	TDZ	KWW	KWD	GAMF	GAMP	max.	kg	G1205	SQ340	AC001	AC002	AC003	
																			[mm]
25A2R034A25-SLN12-C	25	170	25	-	34	-	-	-	-	-23	-8	2	-	19500	✓	0.58	G1205	SQ340	-
25A2R080A25-SLN12-C	25	170	25	-	80	-	-	-	-	-23	-8	2	-	19500	✓	0.51	G1205	SQ340	-
32A2R034A32-SLN12-C	32	195	32	-	34	-	-	-	-	-15	-6	2	-	17300	✓	1.05	G1205	SQ340	-
32A2R090A32-SLN12-C	32	195	32	-	90	-	-	-	-	-15	-6	2	-	17300	✓	0.98	G1205	SQ340	-
25A2R042B25-SLN12-C	25	99	25	-	42	-	-	-	-	-23	-8	2	-	19500	✓	0.30	G1205	SQ340	-
32A3R042B32-SLN12-C	32	103	32	-	42	-	-	-	-	-15	-6	3	-	17300	✓	0.50	G1205	SQ340	-
40A4R050B32-SLN12-C	40	111	32	-	50	-	-	-	-	-15	-6	4	✓	15500	✓	0.62	G1205	SQ340	-
25A2R033M12-SLN12-C	25	55	12.5	-	-	33	-	-	-	-22	-6	2	-	-	✓	0.12	G1205	SQ340	-
32A2R043M16-SLN12-C	32	66	17	-	-	43	-	-	-	-15	-6	2	-	-	✓	0.22	G1205	SQ340	-
32A3R043M16-SLN12-C	32	66	17	-	-	43	-	-	-	-15	-6	3	-	-	✓	0.23	G1205	SQ340	-
40A3R043M16-SLN12-C	40	66	17	-	-	43	-	-	-	-15	-6	3	-	-	✓	0.30	G1205	SQ340	-
40A04R-S90LN12-C	40	-	16	14	-	40	-	8.4	5.6	-15	-6	4	✓	15500	✓	0.23	G1205	SQ342	-
50A04R-S90LN12-C	50	-	22	18	-	40	-	10.4	6.3	-14.5	-6	4	✓	13800	✓	0.35	G1205	SQ343	-
50A05R-S90LN12-C	50	-	22	18	-	40	-	10.4	6.3	-14.5	-6	5	✓	13800	✓	0.11	G1205	SQ343	-
63A04R-S90LN12-C	63	-	22	18	-	40	-	10.4	6.3	-14	-6	4	✓	12300	✓	0.55	G1205	SQ343	-
63A06R-S90LN12-C	63	-	22	18	-	40	-	10.4	6.3	-14	-6	6	✓	12300	✓	0.50	G1205	SQ343	-
80A05R-S90LN12-C	80	-	27	38	-	50	-	12.4	7	-14	-6	5	✓	10900	✓	1.18	G1205	SQ341	AC001
80A07R-S90LN12-C	80	-	27	38	-	50	-	12.4	7	-14	-6	7	✓	10900	✓	1.02	G1205	SQ341	AC001
100A06R-S90LN12-C	100	-	32	45	-	50	-	14.4	8	-14	-6	6	✓	9800	✓	1.78	G1205	SQ341	AC002
100A08R-S90LN12-C	100	-	32	45	-	50	-	14.4	8	-14	-6	8	✓	9800	✓	2.01	G1205	SQ341	AC002
110A06R-S90LN12-C	110	-	32	45	-	50	-	14.4	8	-14	-6	6	✓	9300	✓	2.09	G1205	SQ341	AC002
125A07R-S90LN12-C	125	-	40	56	-	63	-	16.4	9	-14	-6	7	✓	8700	✓	3.44	G1205	SQ341	AC003
125A09R-S90LN12-C	125	-	40	56	-	63	-	16.4	9	-14	-6	9	✓	8700	✓	3.38	G1205	SQ341	AC003

G1205	LNGX 1205..	LNGU 1205..



SQ340	US 44012-T15P	3.5	M 4	12	–	–	Flag T15P	–
SQ341	US 44012-T15P	3.5	M 4	12	D-T08P/T15P	FG-15	–	–
SQ342	US 44012-T15P	3.5	M 4	12	D-T08P/T15P	FG-15	–	HS 0830C
SQ343	US 44012-T15P	3.5	M 4	12	D-T08P/T15P	FG-15	–	HS 1030C

AC001	KS 1230	K.FMH27
AC002	KS 1635	K.FMH32
AC003	KS 2040	K.FMH40

LNGX 12



	W1	D1	L	S
	[mm]	[mm]	[mm]	[mm]
1205	9.500	4.50	12.00	5.96

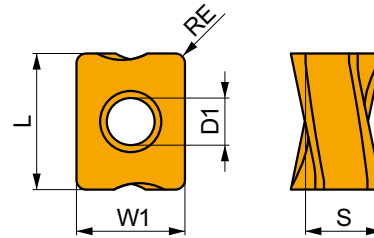

Suitability and starting values for cutting speed (vc), feed (f) and depth of cut (ap). Refer to our Machining Calculator app for further calculations.

Product	RE	P			M			K			N			S			H		
		vc	f	ap	vc	f	ap	vc	f	ap	vc	f	ap	vc	f	ap	vc	f	ap
	[mm]	[m/min]	[mm/tooth]	[mm]	[m/min]	[mm/tooth]	[mm]	[m/min]	[mm/tooth]	[mm]	[m/min]	[mm/tooth]	[mm]	[m/min]	[mm/tooth]	[mm]	[m/min]	[mm/tooth]	[mm]

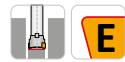
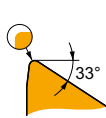

F geometry with highly positive design for light machining.

LNGX 120504ER-F	8215	0.4	200	0.15	1.5	–	–	–	190	0.15	1.5	–	–	–	–	–	–	–	–
	M8330	0.4	200	0.15	1.5	–	–	–	190	0.15	1.5	–	–	–	–	–	–	–	–
	M8340	0.4	180	0.15	1.5	–	–	–	170	0.15	1.5	–	–	–	–	–	–	–	–
LNGX 120508ER-F	8215	0.8	240	0.15	1.5	–	–	–	225	0.15	1.5	–	–	–	–	–	–	–	–
	M8310	0.8	260	0.15	1.5	–	–	–	245	0.15	1.5	–	–	–	–	–	–	–	–
	M8330	0.8	235	0.15	1.5	–	–	–	220	0.15	1.5	–	–	–	–	–	–	–	–
	M8340	0.8	215	0.15	1.5	–	–	–	200	0.15	1.5	–	–	–	–	–	–	–	–

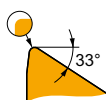

M geometry with positive design for light to medium machining.

LNGX 120504ER-M	M8330	0.4	185	0.15	3.0	–	–	–	175	0.15	3.0	–	–	–	–	–	–	–	–
	M8340	0.4	170	0.15	3.0	–	–	–	160	0.15	3.0	–	–	–	–	–	–	–	–
LNGX 120508ER-M	8215	0.8	220	0.15	3.0	–	–	–	205	0.15	3.0	–	–	–	–	–	–	–	–
	M8310	0.8	240	0.15	3.0	–	–	–	225	0.15	3.0	–	–	–	–	–	–	–	–
	M8330	0.8	220	0.15	3.0	–	–	–	205	0.15	3.0	–	–	–	–	–	–	–	–
	M8340	0.8	200	0.15	3.0	–	–	–	190	0.15	3.0	–	–	–	–	–	–	–	–
	M9315	0.8	300	0.15	3.0	–	–	–	285	0.15	3.0	–	–	–	–	–	–	–	–
	M9325	0.8	280	0.15	3.0	–	–	–	265	0.15	3.0	–	–	–	–	–	–	–	–
LNGX 120510ER-M	M8330	1.0	230	0.15	3.0	–	–	–	215	0.15	3.0	–	–	–	–	–	–	–	–
	M8340	1.0	210	0.15	3.0	–	–	–	195	0.15	3.0	–	–	–	–	–	–	–	–



Suitability and starting values for cutting speed (vc), feed (f) and depth of cut (ap). Refer to our Machining Calculator app for further calculations.

Product	RE [mm]	P			M			K			N			S			H		
		vc [m/min]	f [mm/tooth]	ap [mm]	vc [m/min]	f [mm/tooth]	ap [mm]	vc [m/min]	f [mm/tooth]	ap [mm]	vc [m/min]	f [mm/tooth]	ap [mm]	vc [m/min]	f [mm/tooth]	ap [mm]	vc [m/min]	f [mm/tooth]	ap [mm]

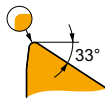
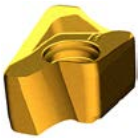

M geometry with positive design for light to medium machining.

LNGX 120512ER-M	M8330	1.2	230	0.15	3.0	–	–	–	215	0.15	3.0	–	–	–	–	–	–	–
	M8340	1.2	210	0.15	3.0	–	–	–	195	0.15	3.0	–	–	–	–	–	–	–
LNGX 120516ER-M	M8330	1.6	240	0.15	3.0	–	–	–	225	0.15	3.0	–	–	–	–	–	–	–
	M8340	1.6	220	0.15	3.0	–	–	–	205	0.15	3.0	–	–	–	–	–	–	–
LNGX 120520ER-M	M8310	2.0	280	0.15	3.0	–	–	–	265	0.15	3.0	–	–	–	–	–	–	–
	M8330	2.0	255	0.15	3.0	–	–	–	240	0.15	3.0	–	–	–	–	–	–	–
	M8340	2.0	230	0.15	3.0	–	–	–	215	0.15	3.0	–	–	–	–	–	–	–

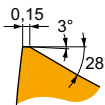

R geometry with positive design for unstable cutting conditions.

LNGX 120508SR-R	8215	0.8	205	0.20	3.5	–	–	–	190	0.20	3.5	–	–	–	–	–	–	–	
	M5315	0.8	265	0.20	3.5	–	–	–	250	0.20	3.5	–	–	–	–	–	–	–	
	M8310	0.8	220	0.20	3.5	–	–	–	205	0.20	3.5	–	–	–	–	–	–	–	
	M8330	0.8	205	0.20	3.5	–	–	–	190	0.20	3.5	–	–	–	–	–	–	–	
	M8340	0.8	185	0.20	3.5	–	–	–	175	0.20	3.5	–	–	–	–	–	–	–	
	M9315	0.8	265	0.20	3.5	–	–	–	250	0.20	3.5	–	–	–	–	–	–	–	–
	M9325	0.8	250	0.20	3.5	–	–	–	235	0.20	3.5	–	–	–	–	–	–	–	–
	M9340	0.8	225	0.20	3.5	–	–	–	–	–	–	–	–	–	–	–	–	–	–
	LNGX 120516SR-R	8215	1.6	225	0.20	3.5	–	–	–	210	0.20	3.5	–	–	–	–	–	–	–
M8330		1.6	225	0.20	3.5	–	–	–	210	0.20	3.5	–	–	–	–	–	–	–	
M8340		1.6	205	0.20	3.5	–	–	–	190	0.20	3.5	–	–	–	–	–	–	–	
M9325		1.6	275	0.20	3.5	–	–	–	260	0.20	3.5	–	–	–	–	–	–	–	

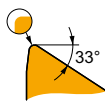

MF geometry with highly positive design for light machining.

LNGX 120504ER-MF	M6330	0.4	175	0.15	1.0	125	0.14	1.0	–	–	–	–	–	–	–	–	–	–
	M8340	0.4	190	0.15	1.0	110	0.14	1.0	–	–	–	–	–	–	–	–	–	–
	M9340	0.4	240	0.15	1.0	140	0.14	1.0	–	–	–	–	–	–	–	–	–	–
LNGX 120508ER-MF	M6330	0.8	210	0.15	1.0	150	0.14	1.0	–	–	–	–	–	–	–	–	–	–
	M8340	0.8	225	0.15	1.0	135	0.14	1.0	–	–	–	–	–	–	–	–	–	–
	M9340	0.8	285	0.15	1.0	170	0.14	1.0	–	–	–	–	–	–	–	–	–	–

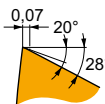

MM geometry with positive design for light to medium machining.

LNGX 120508SR-MM	M6330	0.8	190	0.15	2.8	135	0.14	2.8	–	–	–	–	–	–	–	–	–	–
	M8340	0.8	200	0.15	2.8	120	0.14	2.8	–	–	–	–	–	–	–	–	–	–
	M8345	0.8	160	0.15	2.8	95	0.14	2.8	–	–	–	–	–	–	–	–	–	–
	M9340	0.8	255	0.15	2.8	150	0.14	2.8	–	–	–	–	–	–	–	–	–	–



LNGU 12

PRAMET

	W1	D1	L	S
	[mm]	[mm]	[mm]	[mm]
1205	9.500	4.50	12.00	5.96

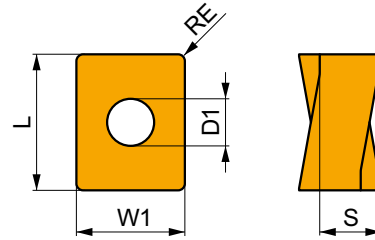

Suitability and starting values for cutting speed (vc), feed (f) and depth of cut (ap). Refer to our Machining Calculator app for further calculations.

Product	RE	P			M			K			N			S			H		
		vc	f	ap	vc	f	ap	vc	f	ap	vc	f	ap	vc	f	ap	vc	f	ap
	[mm]	[m/min]	[mm/tooth]	[mm]	[m/min]	[mm/tooth]	[mm]	[m/min]	[mm/tooth]	[mm]	[m/min]	[mm/tooth]	[mm]	[m/min]	[mm/tooth]	[mm]	[m/min]	[mm/tooth]	[mm]



M geometry with positive design for medium machining.

LNGU 120525ER-M	M8330	2.5	255	0.15	3.0	—	—	—	240	0.15	3.0	—	—	—	—	—	—	—	—	—
	M8340	2.5	230	0.15	3.0	—	—	—	215	0.15	3.0	—	—	—	—	—	—	—	—	—
LNGU 120530ER-M	M8330	3.0	255	0.15	3.0	—	—	—	240	0.15	3.0	—	—	—	—	—	—	—	—	—
	M8340	3.0	230	0.15	3.0	—	—	—	215	0.15	3.0	—	—	—	—	—	—	—	—	—

LNGX 12-FA

PRAMET

	W1	D1	L	S
	[mm]	[mm]	[mm]	[mm]
1205	9.500	4.50	12.00	5.96

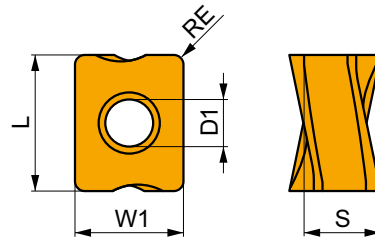

Suitability and starting values for cutting speed (vc), feed (f) and depth of cut (ap). Refer to our Machining Calculator app for further calculations.

Product	RE	P			M			K			N			S			H		
		vc	f	ap	vc	f	ap	vc	f	ap	vc	f	ap	vc	f	ap	vc	f	ap
	[mm]	[m/min]	[mm/tooth]	[mm]	[m/min]	[mm/tooth]	[mm]	[m/min]	[mm/tooth]	[mm]	[m/min]	[mm/tooth]	[mm]	[m/min]	[mm/tooth]	[mm]	[m/min]	[mm/tooth]	[mm]



FA geometry with highly positive design for fine-finish to medium machining.

LNGX 120504FR-FA	HF7	0.4	—	—	—	—	—	—	—	—	270	0.30	2.0	—	—	—	—	—	—
LNGX 120508FR-FA	HF7	0.8	—	—	—	—	—	—	—	—	315	0.30	2.0	—	—	—	—	—	—
	M0315	0.8	—	—	—	—	—	—	—	—	720	0.30	2.0	—	—	—	—	—	—

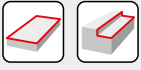

a_s DC	5%	10%	15%	20%	25%	30%	40%	50%	60%	70%	75%	80%	90%	100%
	1.48	1.35	1.27	1.22	1.19	1.16	1.11	1.08	1.05	1.03	1.00	1.00	1.00	1.00
	2.20	1.60	1.35	1.20	1.10	0.95	0.85	0.75	0.85	0.95	1.00	1.00	1.00	1.00
	0.64	0.64	0.64	0.64	0.64	0.65	0.65	0.67	0.68	0.71	0.72	0.74	0.79	1.00

	LNGX 12-F		LNGX 12-M						LNGU 12-M	
	0.4	0.8	0.4	0.8	1.0	1.2	1.6	2.0	2.5	3.0
	2.29	1.89	2.29	1.89	1.69	1.49	1.09	0.68	0.87	0.36

	LNGX 12-R		LNGX 12-MF		LNGX 12-MM	LNGX 12-FA	
	0.8	1.6	0.4	0.8	0.8	0.4	0.8
	1.88	1.08	2.28	1.88	1.88	2.30	1.89

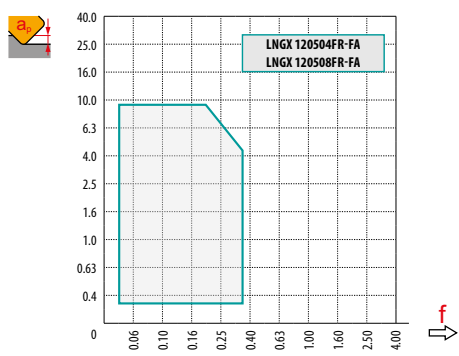
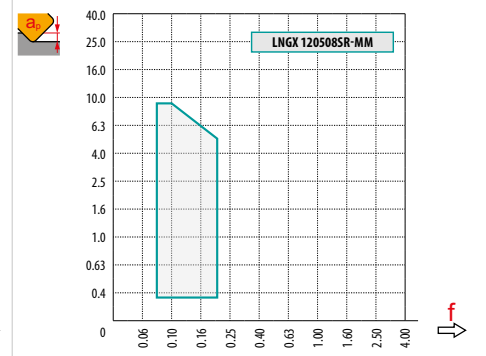
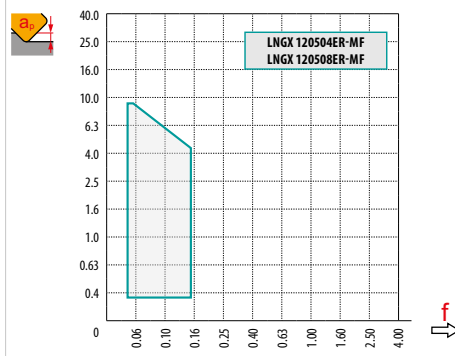
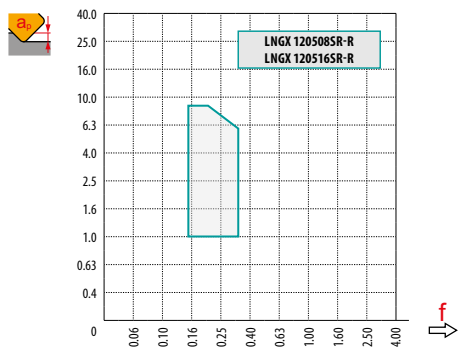
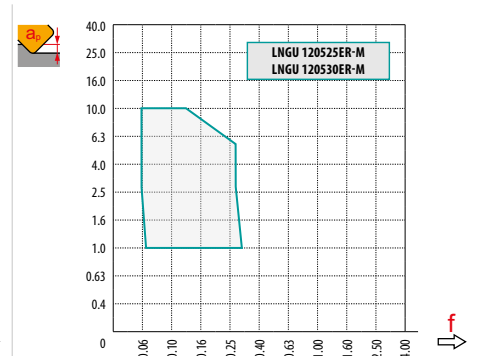
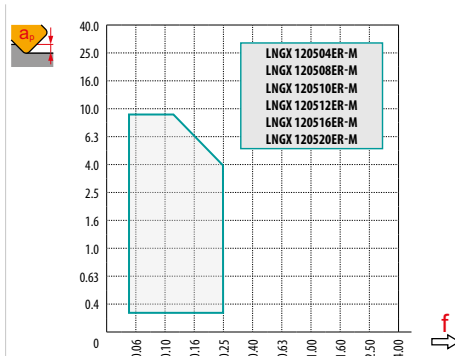
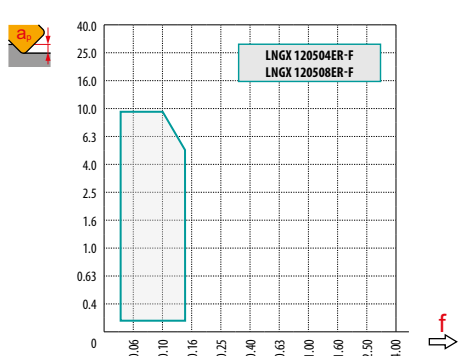

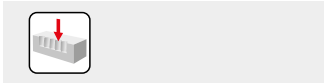

3.5

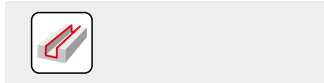

	1.0	5.0	9.0
	0.19	0.13	0.08

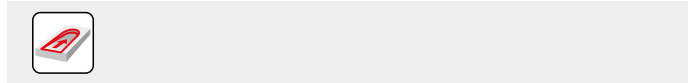

LNGX 12		
	RPMX	APMX/I
25	1.3	2.1/100
32	0.7	1.1/100
40	0.5	0.7/100
50	0.4	0.5/100
63	0.2	0.3/100
80	0.2	0.2/100

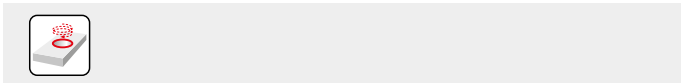

LNGX 12				
	DMIN	DMAX		
25	35.0	50.0	0.7	1.7
32	49.0	64.0	0.6	1.2
40	65.0	80.0	0.6	1.0
50	85.0	100.0	0.7	1.0
63	111.0	126.0	0.6	0.8
80	145.0	160.0	0.7	0.8

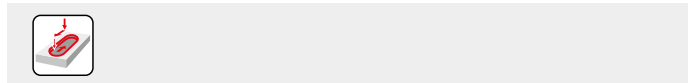

	0.2
--	-----

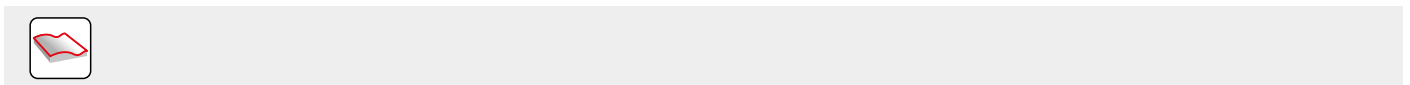

		3	5	10	15	20	30	40	50	60	80	100
25		0.548	0.707	1.000	1.225	1.414	1.732	2.000	2.236	2.449	2.828	3.162
32		0.620	0.800	1.131	1.386	1.600	1.960	2.263	2.530	2.771	3.200	3.578
40		0.693	0.894	1.265	1.549	1.789	2.191	2.530	2.828	3.098	3.578	4.000
50		0.775	1.000	1.414	1.732	2.000	2.449	2.828	3.162	3.464	4.000	4.472
63		0.869	1.122	1.587	1.944	2.245	2.750	3.175	3.550	3.888	4.490	5.020
80		0.980	1.265	1.789	2.191	2.530	3.098	3.578	4.000	4.382	5.060	5.657

		3	5	10	15	20	30	40	50	60	80	100
1.6		0.196	0.253	0.358	0.438	0.506	0.620	0.716	0.800	0.876	1.012	1.131
2.0		0.219	0.283	0.400	0.490	0.566	0.693	0.800	0.894	0.980	1.131	1.265
2.5		0.245	0.316	0.447	0.548	0.632	0.775	0.894	1.000	1.095	1.265	1.414
3.0		0.268	0.346	0.490	0.600	0.693	0.849	0.980	1.095	1.200	1.386	1.549



SLN16



PRAMET

S



ECON LN16 Square Shoulder Mill with Internal Coolant

90° shell mill utilising double sided LN.. 16 inserts with APMX of 13 mm. Suitable for a wide range of applications. Available in arbor style in Ø63 up to Ø175 mm with differential tooth pitch. Body treated for longer tool life.

ECON LN

KAPR	90°
APMX	13.0 mm

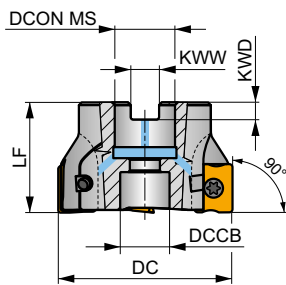
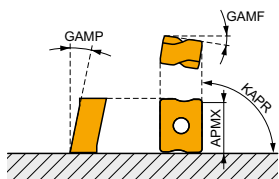

DC 63 – 140 mm

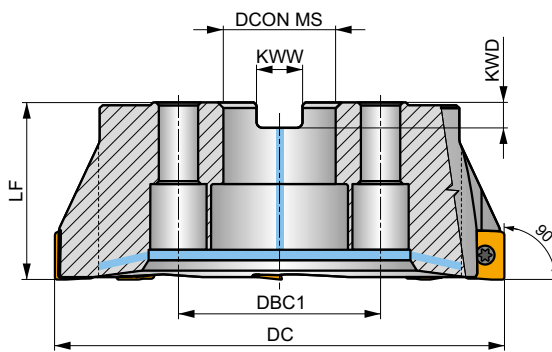

DC 160 – 175 mm

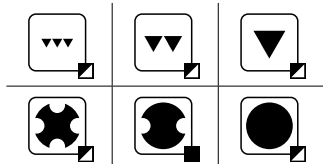

h_m 0.08 - 0.2



Product	DC (mm)	LF (mm)	DCON MS (mm)	DCCB (mm)	DBC1 (mm)	KWW (mm)	KWD (mm)	GAMP (°)	GAMP (°)	max.	kg	G127	SQ351	SQ353	AC001	AC002	AC003
63A04R-S90LN16-C	63	40	22	18	-	10.4	6.3	-10.5	-6	4	✓	7600	✓	0.46	G1207	SQ353	-
63A05R-S90LN16-C	63	40	22	18	-	10.4	6.3	-10.5	-6	5	✓	7600	✓	0.46	G1207	SQ353	-
80A04R-S90LN16-C	80	50	27	38	-	12.4	7	-10.5	-6	4	✓	6800	✓	0.98	G1207	SQ351	AC001
80A06R-S90LN16-C	80	50	27	38	-	12.4	7	-10.5	-6	6	✓	6800	✓	0.89	G1207	SQ351	AC001
100A05R-S90LN16-C	100	50	32	45	-	14.4	8	-10.5	-6	5	✓	6100	✓	0.98	G1207	SQ351	AC002
100A07R-S90LN16-C	100	50	32	45	-	14.4	8	-10.5	-6	7	✓	6100	✓	1.84	G1207	SQ351	AC002
125A06R-S90LN16-C	125	63	40	56	-	16.4	9	-10.5	-6	6	✓	5400	✓	3.44	G1207	SQ351	AC003
125A08R-S90LN16-C	125	63	40	56	-	16.4	9	-10.5	-6	8	✓	5400	✓	3.33	G1207	SQ351	AC003
140A06R-S90LN16-C	140	63	40	56	-	16.4	9	-10.5	-6	6	✓	5100	✓	3.91	G1207	SQ351	AC003
160C08R-S90LN16-C	160	63	40	-	66.7	16.4	9	-10.5	-6	8	✓	4700	✓	6.19	G1207	SQ356	-
175C08R-S90LN16-C	175	63	40	-	66.7	16.4	9	-10.5	-6	8	✓	4500	✓	7.11	G1207	SQ356	-



G1207



LNMU 1607..



LNGU 1607..



SQ351



US 45012-T20P



5.0



M 5



12



SDR T20P-T



HS 1030C



CAC 160C



HSD 0825C



HXK 5



AC001	KS 1230	K.FMH27
AC002	KS 1635	K.FMH32
AC003	KS 2040	K.FMH40

LNMU 16



	W1	D1	L	S
	[mm]	[mm]	[mm]	[mm]
1607	13.200	5.70	16.60	7.50

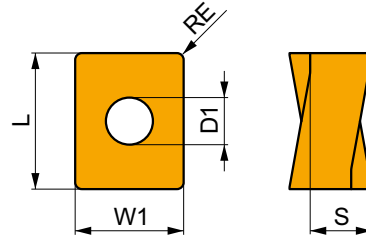

Suitability and starting values for cutting speed (vc), feed (f) and depth of cut (ap). Refer to our Machining Calculator app for further calculations.

Product	RE	P			M			K			N			S			H		
		vc	f	ap	vc	f	ap	vc	f	ap	vc	f	ap	vc	f	ap	vc	f	ap
	[mm]	[m/min]	[mm/tooth]	[mm]	[m/min]	[mm/tooth]	[mm]	[m/min]	[mm/tooth]	[mm]	[m/min]	[mm/tooth]	[mm]	[m/min]	[mm/tooth]	[mm]	[m/min]	[mm/tooth]	[mm]



F geometry with highly positive design for light machining.

LNMU 160708ER-F	8215	0.8	235	0.16	1.7	-	-	-	-	-	-	-	-	-	-	-	-	-	-
	M8330	0.8	230	0.16	1.7	-	-	-	-	-	-	-	-	-	-	-	-	-	-
	M8340	0.8	210	0.16	1.7	-	-	-	-	-	-	-	-	-	-	-	-	-	-

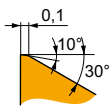

M geometry with positive design for medium machining.

LNMU 160708SR-M	8215	0.8	200	0.18	5.0	-	-	-	190	0.18	5.0	-	-	-	-	-	-	-	-
	M6330	0.8	170	0.18	5.0	-	-	-	-	-	-	-	-	-	-	-	-	-	-
	M8330	0.8	200	0.18	5.0	-	-	-	190	0.18	5.0	-	-	-	-	-	-	-	-
	M8340	0.8	180	0.18	5.0	-	-	-	170	0.18	5.0	-	-	-	-	-	-	-	-
	M9325	0.8	250	0.18	5.0	-	-	-	235	0.18	5.0	-	-	-	-	-	-	-	-
LNMU 160720SR-M	M8330	2.0	230	0.18	5.0	-	-	-	215	0.18	5.0	-	-	-	-	-	-	-	-
	M8340	2.0	210	0.18	5.0	-	-	-	195	0.18	5.0	-	-	-	-	-	-	-	-
LNMU 160730SR-M	M8330	3.0	230	0.18	5.0	-	-	-	215	0.18	5.0	-	-	-	-	-	-	-	-
	M8340	3.0	210	0.18	5.0	-	-	-	195	0.18	5.0	-	-	-	-	-	-	-	-
LNMU 160740SR-M	M8330	4.0	230	0.18	5.0	-	-	-	215	0.18	5.0	-	-	-	-	-	-	-	-
	M8340	4.0	210	0.18	5.0	-	-	-	195	0.18	5.0	-	-	-	-	-	-	-	-

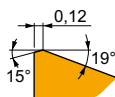

R geometry with positive stable design for medium machining.

LNMU 160708SR-R	M5315	0.8	265	0.18	6.3	-	-	-	250	0.18	6.3	-	-	-	50	0.15	1.0
	M8310	0.8	215	0.18	6.3	-	-	-	200	0.18	6.3	-	-	-	40	0.15	1.0
	M8330	0.8	195	0.18	6.3	-	-	-	185	0.18	6.3	-	-	-	35	0.15	1.0
	M8340	0.8	175	0.18	6.3	-	-	-	165	0.18	6.3	-	-	-	-	-	-
	M9315	0.8	260	0.18	6.3	-	-	-	245	0.18	6.3	-	-	-	50	0.15	1.0
	M9325	0.8	240	0.18	6.3	-	-	-	225	0.18	6.3	-	-	-	45	0.15	1.0



Suitability and starting values for cutting speed (vc), feed (f) and depth of cut (ap). Refer to our Machining Calculator app for further calculations.

Product	RE [mm]	P			M			K			N			S			H		
		vc [m/min]	f [mm/tooth]	ap [mm]	vc [m/min]	f [mm/tooth]	ap [mm]	vc [m/min]	f [mm/tooth]	ap [mm]	vc [m/min]	f [mm/tooth]	ap [mm]	vc [m/min]	f [mm/tooth]	ap [mm]	vc [m/min]	f [mm/tooth]	ap [mm]

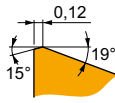

R geometry with positive stable design for medium machining.

LNMU 160716SR-R	M8330	1.6	■	215	0.18	6.3	■	–	–	–	■	200	0.18	6.3	■	–	–	–	■	40	0.15	1.0
	M8340	1.6	■	195	0.18	6.3	■	–	–	–	■	185	0.18	6.3	■	–	–	–	■	–	–	–
	M9315	1.6	■	285	0.18	6.3	■	–	–	–	■	270	0.18	6.3	■	–	–	–	■	55	0.15	1.0
	M9325	1.6	■	265	0.18	6.3	■	–	–	–	■	250	0.18	6.3	■	–	–	–	■	50	0.15	1.0

LNGU 16



	W1 [mm]	D1 [mm]	L [mm]	S [mm]
1607	13.200	5.70	16.60	7.50

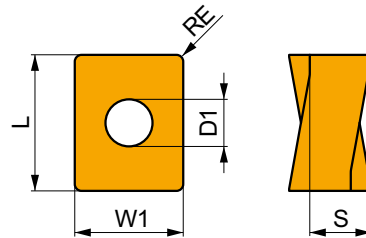

Suitability and starting values for cutting speed (vc), feed (f) and depth of cut (ap). Refer to our Machining Calculator app for further calculations.

Product	RE [mm]	P			M			K			N			S			H		
		vc [m/min]	f [mm/tooth]	ap [mm]	vc [m/min]	f [mm/tooth]	ap [mm]	vc [m/min]	f [mm/tooth]	ap [mm]	vc [m/min]	f [mm/tooth]	ap [mm]	vc [m/min]	f [mm/tooth]	ap [mm]	vc [m/min]	f [mm/tooth]	ap [mm]

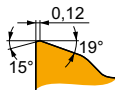
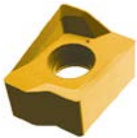

M geometry with highly positive design for medium machining.

LNGU 160708SR-M	8215	0.8	■	200	0.18	5.0	■	–	–	–	■	190	0.18	5.0	■	–	–	–	■	40	0.15	1.0
	M8340	0.8	■	180	0.18	5.0	■	–	–	–	■	170	0.18	5.0	■	–	–	–	■	–	–	–
	M9315	0.8	■	265	0.18	5.0	■	–	–	–	■	250	0.18	5.0	■	–	–	–	■	50	0.15	1.0
	M9325	0.8	■	250	0.18	5.0	■	–	–	–	■	235	0.18	5.0	■	–	–	–	■	50	0.15	1.0



LNGU 16-FA

	W1	D1	L	S
	[mm]	[mm]	[mm]	[mm]
1607	13.200	5.70	16.60	7.50

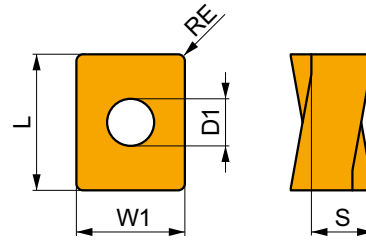

Suitability and starting values for cutting speed (vc), feed (f) and depth of cut (ap). Refer to our Machining Calculator app for further calculations.

Product	RE [mm]	P			M			K			N			S			H		
		vc [m/min]	f [mm/tooth]	ap [mm]	vc [m/min]	f [mm/tooth]	ap [mm]	vc [m/min]	f [mm/tooth]	ap [mm]	vc [m/min]	f [mm/tooth]	ap [mm]	vc [m/min]	f [mm/tooth]	ap [mm]			



FA geometry with highly positive design for fine-finish to medium machining.

LNGU 160708FR-FA	HF7	0.8	-	-	-	-	-	-	-	300	0.30	3.0	-	-	-	-	-	-
------------------	-----	-----	---	---	---	---	---	---	---	-----	------	-----	---	---	---	---	---	---

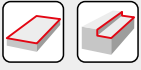

a_s / DC	5%	10%	15%	20%	25%	30%	40%	50%	60%	70%	75%	80%	90%	100%
	1.48	1.35	1.27	1.22	1.19	1.16	1.11	1.08	1.05	1.03	1.00	1.00	1.00	1.00
	2.20	1.60	1.35	1.20	1.10	0.95	0.85	0.75	0.85	0.95	1.00	1.00	1.00	1.00
	0.64	0.64	0.64	0.64	0.64	0.65	0.65	0.67	0.68	0.71	0.72	0.74	0.79	1.00

	LNMU 16-F	LNMU 16-M					LNMU 16-R		LNGU 16-M	LNGU 16-FA
	0.8	0.8	2.0	3.0	4.0	0.8	1.6	0.8	0.8	
	3.30	3.30	2.11	1.12	0.10	3.30	2.50	3.24	3.30	

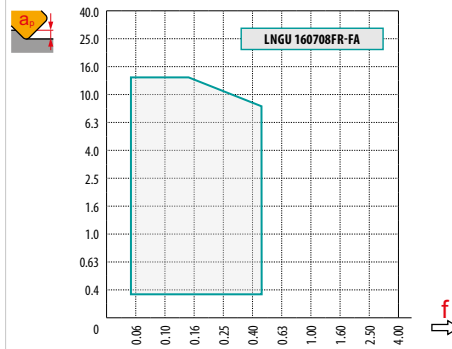
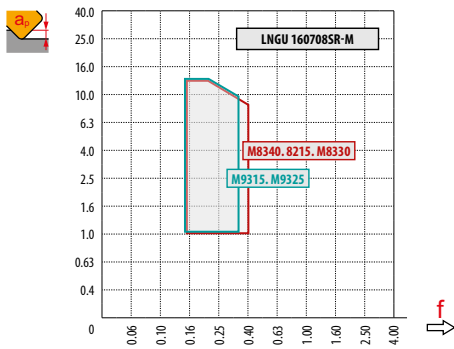
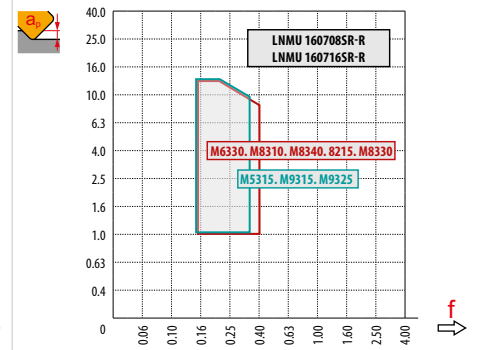
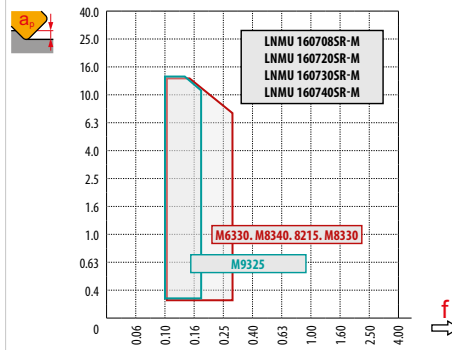
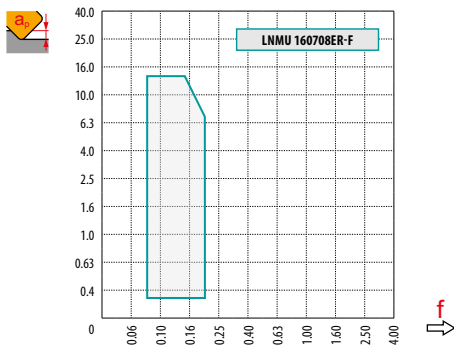

max.
7.0



	1.0	6.0	13.0
	0.31	0.24	0.13



SS0050



PRAMET

S



90° Square Shoulder Mill for SOMT 05 Insert with Internal Coolant

90° end and shell mills utilising positive SOMT 05 inserts with APMX of 4.5 mm. Suitable for face, shoulder, slot and plunge milling. Available in cylindrical, Weldon and arbor style, in Ø12 up to Ø40 mm and with differential tooth pitch. Body treated for longer tool life.

KAPR	90°
APMX	4.5 mm

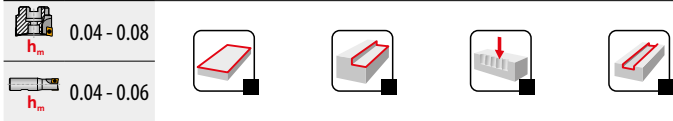
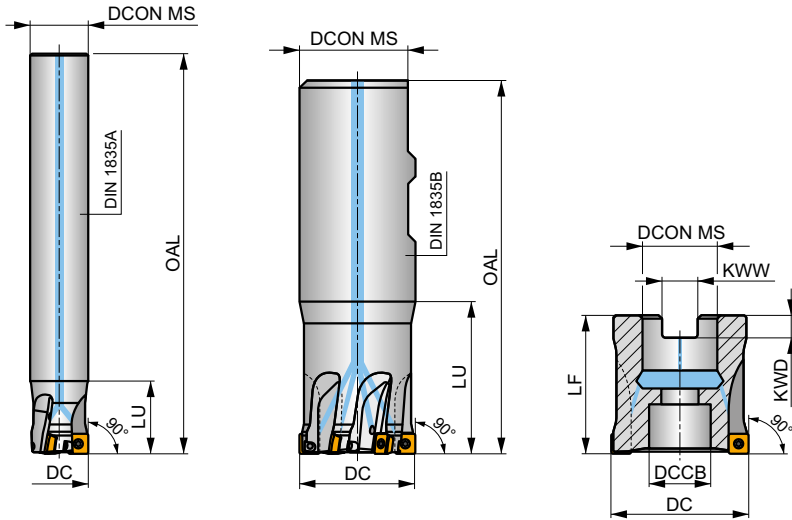
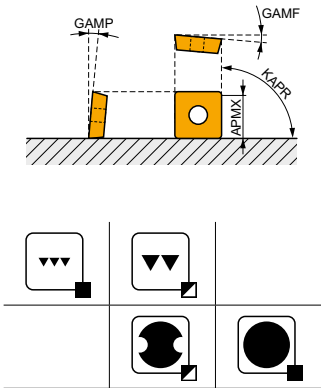

Product	DC	OAL	DCON MS	DCCB	LU	LF	KWW	KWD	GAMF	GAMP	Flute Patterns	max.	kg	ISO 6462	SQ327	SQ330	
	[mm]	[mm]	[mm]	[mm]	[mm]	[mm]	[mm]	[mm]	[°]	[°]							
12A2R018A10-SS0050-C	12	90	10	-	18	-	-	-	-8	8	2	-	58000	✓	0.05	GI327	SQ330
12A2R018A12-SS0050-C	12	90	12	-	18	-	-	-	-8	8	2	-	58000	✓	0.07	GI327	SQ330
16A3R020A14-SS0050-C	16	110	14	-	20	-	-	-	-5	8	3	-	50300	✓	0.12	GI327	SQ330
16A3R020A16-SS0050-C	16	110	16	-	20	-	-	-	-5	8	3	-	50300	✓	0.15	GI327	SQ330
20A4R020A18-SS0050-C	20	125	18	-	20	-	-	-	-5	8	4	✓	45000	✓	0.21	GI327	SQ330
20A4R020A20-SS0050-C	20	125	20	-	20	-	-	-	-5	8	4	✓	45000	✓	0.26	GI327	SQ330
25A5R024A25-SS0050-C	25	140	25	-	24	-	-	-	-5	8	5	✓	40200	✓	0.48	GI327	SQ330
20A4R032B20-SS0050-C	20	83	20	-	32	-	-	-	-5	8	4	✓	45000	✓	0.16	GI327	SQ330
25A5R042B25-SS0050-C	25	99	25	-	42	-	-	-	-5	8	5	✓	40200	✓	0.31	GI327	SQ330
32A6R042B32-SS0050-C	32	103	32	-	42	-	-	-	-4.5	8	6	✓	35500	✓	0.54	GI327	SQ330
32A06R-S90S0050-C	32	-	16	12.4	-	32	8.4	5.6	-4.5	8	6	✓	35500	✓	0.10	GI327	SQ332
40A08R-S90S0050-C	40	-	22	18.1	-	40	10.4	6.3	-4	8	8	✓	31800	✓	0.19	GI327	SQ333



Tool Type	Part Number	Nm	Thread	Length	Flag	Coating	Material	Material
SQ330	US 62204-T07P	0.8	M 2.2	4.1	Flag T07P	-	-	-
SQ332	US 62204-T07P	0.8	M 2.2	4.1	-	D-T07P/T09P	FG-15	HS 90835
SQ333	US 62204-T07P	0.8	M 2.2	4.1	-	D-T07P/T09P	FG-15	HS 1030C



SOMT 05

	IC	D1	L	S
	[mm]	[mm]	[mm]	[mm]
0502	5.570	2.50	5.57	2.63

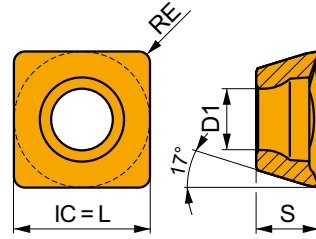

Suitability and starting values for cutting speed (vc), feed (f) and depth of cut (ap). Refer to our Machining Calculator app for further calculations.

Product	RE	P			M			K			N			S			H		
		vc	f	ap	vc	f	ap	vc	f	ap	vc	f	ap	vc	f	ap	vc	f	ap
	[mm]	[m/min]	[mm/tooth]	[mm]	[m/min]	[mm/tooth]	[mm]	[m/min]	[mm/tooth]	[mm]	[m/min]	[mm/tooth]	[mm]	[m/min]	[mm/tooth]	[mm]	[m/min]	[mm/tooth]	[mm]

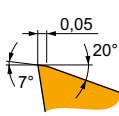

M geometry with positive design for light to medium machining.

SOMT 050204SR-M	M6330	0.4	255	0.05	2.5	180	0.05	2.5	—	—	—	75	0.04	2.0	—	—	—
	M8330	0.4	290	0.05	2.5	170	0.05	2.5	275	0.05	2.5	70	0.04	2.0	—	—	—
	M8340	0.4	260	0.05	2.5	155	0.05	2.5	245	0.05	2.5	65	0.04	2.0	—	—	—
SOMT 050208SR-M	M6330	0.8	300	0.05	2.5	210	0.05	2.5	—	—	—	85	0.04	2.0	—	—	—
	M8330	0.8	350	0.05	2.5	210	0.05	2.5	330	0.05	2.5	85	0.04	2.0	—	—	—
	M8340	0.8	310	0.05	2.5	185	0.05	2.5	290	0.05	2.5	75	0.04	2.0	—	—	—



a_e / DC	5 %	10 %	15 %	20 %	25 %	30 %	40 %	50 %	60 %	70 %	75 %	80 %	90 %	100 %
	1.48	1.35	1.27	1.22	1.19	1.16	1.11	1.08	1.05	1.03	1.00	1.00	1.00	1.00
	2.20	1.60	1.35	1.20	1.10	0.95	0.85	0.75	0.85	0.95	1.00	1.00	1.00	1.00
	0.64	0.64	0.64	0.64	0.64	0.65	0.65	0.67	0.68	0.71	0.72	0.74	0.79	1.00

	SOMT 05-M	
	0.4	0.8
	-	-

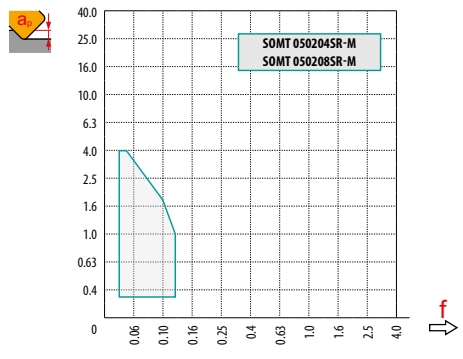

1.5

	1.0	2.0	4.0
	0.12	0.08	0.03



SS009

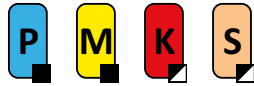

PRAMET



90° Square Shoulder Mill for SOMT 09 Insert with Internal Coolant

90° end and shell mills utilising positive SOMT 09 inserts with APMX of 8 mm. Suitable for face, shoulder, slot and plunge milling. Available in Weldon and arbor style, in Ø20 up to Ø125 mm. Differential tooth pitch available. Body treated for longer tool life.

KAPR	90°
APMX	8.0 mm

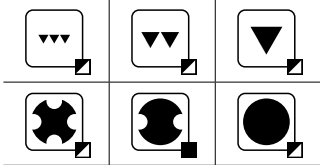
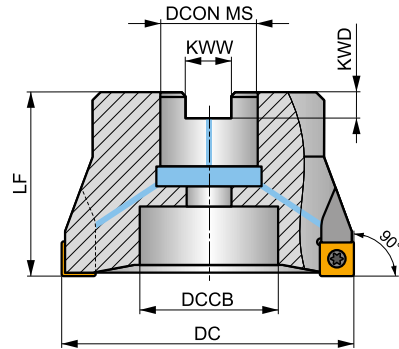
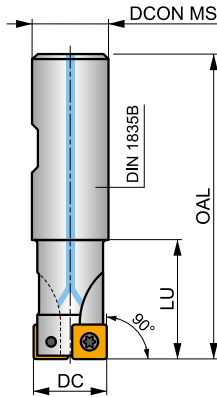
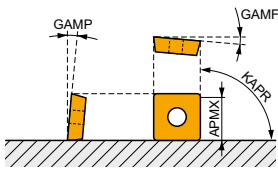

m	0.07 - 0.18
---	-------------



Product	DC	OAL	DCON MS	DCCB	LU	LF	KWW	KWD	GAMF	GAMP										
	[mm]	[mm]	[mm]	[mm]	[mm]	[mm]	[mm]	[mm]	[°]	[°]										
20A2R032B20-SS009-C	20	82	20	-	32	-	-	-	-12	6	2	-	23800	✓	0.21	G146	SQ400	-	-	-
25A3R042B25-SS009-C	25	98	25	-	42	-	-	-	-12	6	3	-	21300	✓	0.31	G146	SQ400	-	-	-
32A4R042B32-SS009-C	32	102	32	-	42	-	-	-	-10	10	4	✓	18800	✓	0.55	G146	SQ400	-	-	-
40A05R-S90S009-C	40	-	16	14	-	40	8.4	5.6	-9.1	10	5	-	16800	✓	0.29	G146	SQ402	-	-	-
50A06R-S90S009-C	50	-	22	18	-	40	10.4	6.4	-8.8	10	6	-	15100	✓	0.33	G146	SQ403	-	-	-
63A07R-S90S009-C	63	-	22	18	-	40	10.4	6.4	-8.6	10	7	-	13400	✓	0.86	G146	SQ403	-	-	-
80A09R-S90S009-C	80	-	27	38	-	50	12.4	7	-8.1	10	9	-	11900	✓	1.03	G146	SQ401	AC001	-	-
100A10R-S90S009-C	100	-	32	45	-	50	14.4	8	-8.1	10	10	-	10700	✓	1.79	G146	SQ401	AC002	-	-
125A12R-S90S009-C	125	-	40	56	-	63	16.4	9	-8.1	10	12	-	9500	✓	3.62	G146	SQ401	AC003	-	-

G146	SOMT 09T3..

SQ400	US 3006-T09P	2.0	M3	6	-	-	Flag T09P	-	-
SQ401	US 3006-T09P	2.0	M3	6	D-T07P/T09P	FG-15	-	-	-
SQ402	US 3006-T09P	2.0	M3	6	D-T07P/T09P	FG-15	-	-	HS 0830C
SQ403	US 3006-T09P	2.0	M3	6	D-T07P/T09P	FG-15	-	-	HS 1030C

AC001	KS 1230	K.FMH27



AC002	KS 1635	K.FMH32
AC003	KS 2040	K.FMH40

SOMT 09



	IC	D1	L	S
	[mm]	[mm]	[mm]	[mm]
09T3	9.550	3.50	9.55	3.97

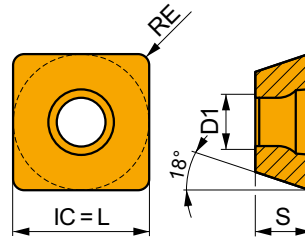

Suitability and starting values for cutting speed (vc), feed (f) and depth of cut (ap). Conditions are valid for setting angle 90°. Refer to our Machining Calculator app for further calculations.

Product	RE [mm]	P			M			K			N			S			H		
		vc [m/min]	f [mm/tooth]	ap [mm]	vc [m/min]	f [mm/tooth]	ap [mm]	vc [m/min]	f [mm/tooth]	ap [mm]	vc [m/min]	f [mm/tooth]	ap [mm]	vc [m/min]	f [mm/tooth]	ap [mm]	vc [m/min]	f [mm/tooth]	ap [mm]

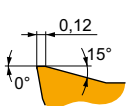

M geometry with positive design for medium machining.

SOMT 09T308-M	8215	0.8	275	0.14	2.5	165	0.13	2.5	260	0.14	2.5	65	0.13	2.0			
	M5315	0.8	390	0.14	2.5				370	0.14	2.5						
	M8330	0.8	270	0.14	2.5	160	0.13	2.5	255	0.14	2.5	65	0.13	2.0			
	M8340	0.8	250	0.14	2.5	150	0.13	2.5	235	0.14	2.5	60	0.13	2.0			
	M9315	0.8	380	0.14	2.5				360	0.14	2.5						

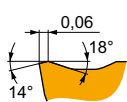
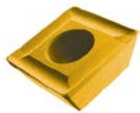

MI geometry with stable positive design for medium machining.

SOMT 09T304-MI	8215	0.4	230	0.14	2.5	135	0.13	2.5	215	0.14	2.5	55	0.10	2.0			
	M8310	0.4	255	0.14	2.5	130	0.13	2.5	240	0.14	2.5						
	M8330	0.4	230	0.14	2.5	135	0.13	2.5	215	0.14	2.5	55	0.10	2.0			
	M8340	0.4	210	0.14	2.5	125	0.13	2.5	195	0.14	2.5	50	0.10	2.0			
	M9315	0.4	320	0.14	2.5				300	0.14	2.5						
M9340	0.4	265	0.14	2.5	155	0.13	2.5				65	0.10	2.0				

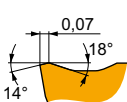
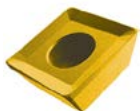

P geometry with highly positive design for medium machining.

SOMT 09T304-P	M8330	0.4	250	0.14	2.5	150	0.13	2.5	235	0.14	2.5	60	0.10	2.0			
	M8340	0.4	230	0.14	2.5	135	0.13	2.5	215	0.14	2.5	55	0.10	2.0			
	M9325	0.4	320	0.14	2.5				300	0.14	2.5						

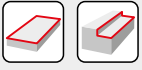

a_e DC	5 %	10 %	15 %	20 %	25 %	30 %	40 %	50 %	60 %	70 %	75 %	80 %	90 %	100 %
	1.48	1.35	1.27	1.22	1.19	1.16	1.11	1.08	1.05	1.03	1.00	1.00	1.00	1.00
	2.20	1.60	1.35	1.20	1.10	0.95	0.85	0.75	0.85	0.95	1.00	1.00	1.00	1.00
	0.64	0.64	0.64	0.64	0.64	0.65	0.65	0.67	0.68	0.71	0.72	0.74	0.79	1.00

	SOMT 09-M	SOMT 09-MI	SOMT 09-P
	0.8	0.4	0.4
	0.90	1.30	1.30

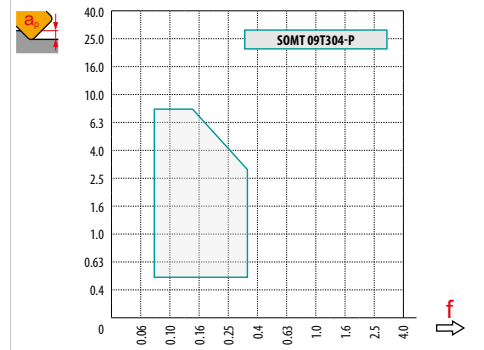
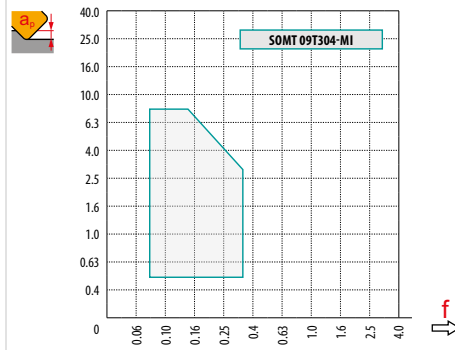
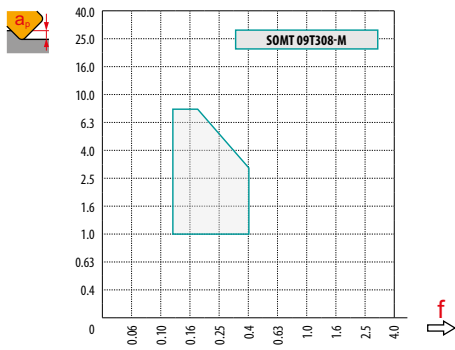

	6.0

	1.0	4.0	8.0
	0.28	0.19	0.09



SSD12

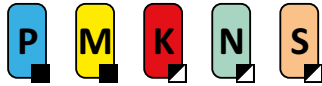

PRAMET

S



90° Square Shoulder Mill for SDMT 12 Insert with Internal Coolant

90° shell mill utilising positive SDMT 12 inserts with APMX of 10 mm. Suitable for face, shoulder, slot and plunge milling. Available in arbor style only in Ø50 up to Ø160 mm. Body treated for longer tool life.

KAPR	90°
APMX	10.0 mm

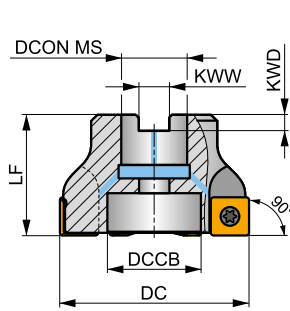
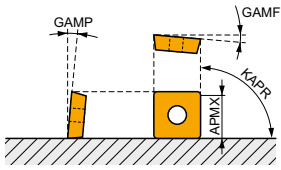

DC 50 - 125 mm

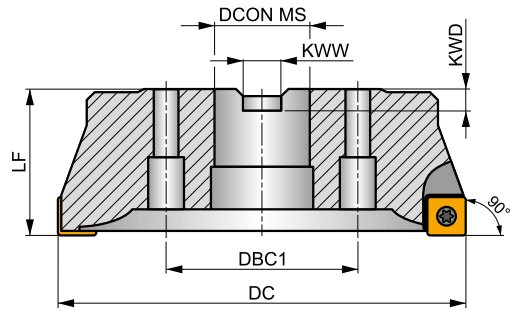

DC 160 mm

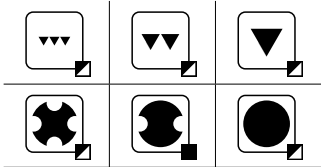

h_m 0.09 - 0.25



Product	DC	LF	DCON MS	DCCB	DBC1	KWW	KWD	GAMF	GAMP	ISO 6462 DIN 9130	max.	kg	GI057	SQ413	AC001	AC002	AC003
	[mm]	[mm]	[mm]	[mm]	[mm]	[mm]	[mm]	[°]	[°]								
50A05R-S90SD12-C	50	40	22	18	-	10.4	6.3	-5	8	5	-	13000	✓	0.34	GI057	SQ413	-
63A06R-S90SD12-C	63	40	22	18	-	10.4	6.3	-5	8	6	-	11600	✓	0.53	GI057	SQ413	-
80A06R-S90SD12-C	80	50	27	38	-	12.4	7	-5	8	6	-	10300	✓	0.92	GI057	SQ411	AC001
100A08R-S90SD12-C	100	50	32	45	-	14.4	8	-5	8	8	-	9200	✓	1.69	GI057	SQ411	AC002
125A09R-S90SD12-C	125	63	40	56	-	16.4	9	-5	8	9	-	8300	✓	3.29	GI057	SQ411	AC003
160C12R-S90SD12	160	63	40	-	66.7	16.4	9	-5	8	12	-	7300	-	5.74	GI057	SQ411	-

GI057	SDMT 1205..
-------	-------------

SQ411	SSN 100312	MS 3510	HXK 3,5	US 3511-T15	3.0	M 3.5	11	D-T07/T15	FG-15	-
SQ413	-	-	-	US 3511-T15	3.0	M 3.5	11	D-T07/T15	FG-15	HS 1030C

AC001	KS 1230	K.FMH27
AC002	KS 1635	K.FMH32
AC003	KS 2040	K.FMH40



SDMT 12

	IC	D1	L	S
	[mm]	[mm]	[mm]	[mm]
1205	12.700	4.40	12.70	5.00

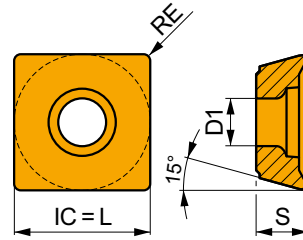

Suitability and starting values for cutting speed (vc), feed (f) and depth of cut (ap). Refer to our Machining Calculator app for further calculations.

Product	RE	P			M			K			N			S			H		
		vc	f	ap	vc	f	ap	vc	f	ap	vc	f	ap	vc	f	ap	vc	f	ap
	[mm]	[m/min]	[mm/tooth]	[mm]	[m/min]	[mm/tooth]	[mm]	[m/min]	[mm/tooth]	[mm]	[m/min]	[mm/tooth]	[mm]	[m/min]	[mm/tooth]	[mm]	[m/min]	[mm/tooth]	[mm]

F geometry with positive design for light to medium machining.

SDMT 120508SR-F	M8330	0.8	■	275	0.10	3.0	☑	165	0.09	3.0	☑	260	0.10	3.0	☑	825	0.12	3.0	☑	65	0.08	2.4	–	–	–
	M8340	0.8	■	250	0.10	3.0	☑	150	0.09	3.0	☑	235	0.10	3.0	☑	–	–	–	☑	60	0.08	2.4	–	–	–

M geometry with positive design for light to medium machining.

SDMT 120508SR-M	8215	0.8	■	245	0.16	3.5	☑	145	0.14	3.5	☑	230	0.16	3.5	–	–	–	☑	60	0.11	2.8	–	–	–
	M8330	0.8	■	240	0.16	3.5	■	140	0.14	3.5	☑	225	0.16	3.5	–	–	–	☑	60	0.11	2.8	–	–	–
	M8340	0.8	■	220	0.16	3.5	■	130	0.14	3.5	☑	205	0.16	3.5	–	–	–	☑	55	0.11	2.8	–	–	–
	M9325	0.8	■	305	0.16	3.5	–	–	–	☑	285	0.16	3.5	–	–	–	–	–	–	–	–	–	–	–

R geometry with stable positive design for medium machining.

SDMT 120508PR-R	M8330	0.8	■	220	0.25	3.5	☑	130	0.23	3.5	■	205	0.25	3.5	–	–	–	☑	55	0.23	2.8	–	–	–
	M8340	0.8	■	195	0.25	3.5	☑	115	0.23	3.5	☑	185	0.25	3.5	–	–	–	☑	45	0.23	2.8	–	–	–
	M9315	0.8	■	280	0.25	3.5	–	–	–	■	265	0.25	3.5	–	–	–	–	–	–	–	–	–	–	–
	M9325	0.8	■	265	0.25	3.5	–	–	–	■	250	0.25	3.5	–	–	–	–	–	–	–	–	–	–	–

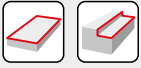

a_e / DC	5 %	10 %	15 %	20 %	25 %	30 %	40 %	50 %	60 %	70 %	75 %	80 %	90 %	100 %
	1.48	1.35	1.27	1.22	1.19	1.16	1.11	1.08	1.05	1.03	1.00	1.00	1.00	1.00
	2.20	1.60	1.35	1.20	1.10	0.95	0.85	0.75	0.85	0.95	1.00	1.00	1.00	1.00
	0.64	0.64	0.64	0.64	0.64	0.65	0.65	0.67	0.68	0.71	0.72	0.74	0.79	1.00

	SDMT 12-F	SDMT 12-M	SDMT 12-R
	0.8	0.8	0.8
	-	-	-

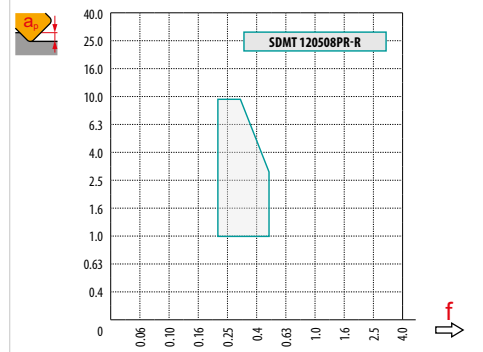
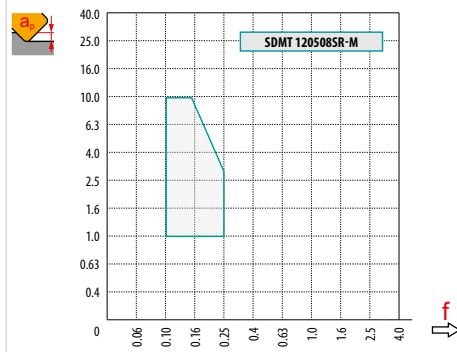
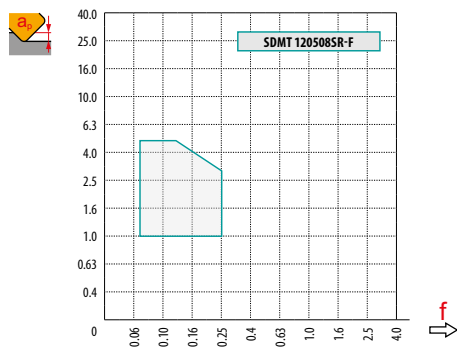

	8.0

	1.0	5.0	10.0
	0.39	0.25	0.14



FTB27X

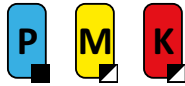

PRAMET



ROUGH TB Square Shoulder Face Mill for TBMR 27 Insert for Heavy Milling

90° shell mill utilising positive TBMR 27 inserts with APMX of 18 mm. Suitable for heavy face, shoulder and slot milling. Available in arbor style only in Ø140 up to Ø260 mm and with differential tooth pitch. Body treated for longer tool life.

ROUGH TB

KAPR	90°
APMX	18.0 mm

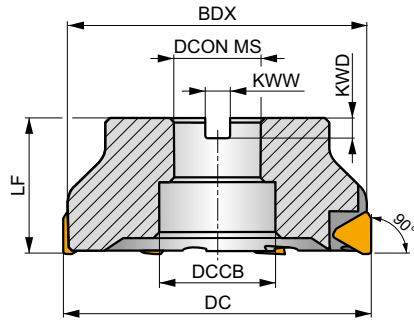
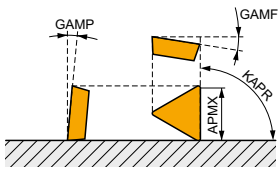

DC 140 mm

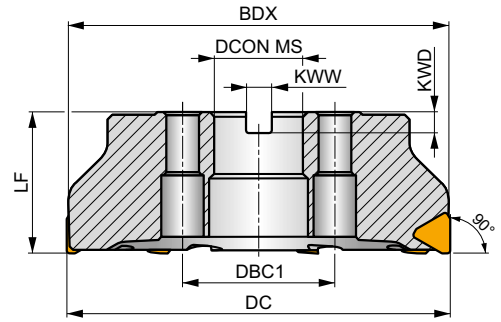

DC 175 – 260 mm

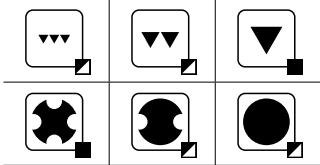

h_m 0.15 - 0.38

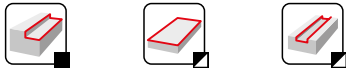

Product	DC	BDX	LF	D CON MS	DCCB	DBC1	KWW	KWD	GAMF	GAMP					kg			
	[mm]	[mm]	[mm]	[mm]	[mm]	[mm]	[mm]	[mm]	[°]	[°]								
140B07R-F90TB27X	140	135.7	63	40	56	-	16.4	9	-9	9	7	✓	-	-	4.75	GI163	SQ421	AC003
175C08R-F90TB27X	175	169.6	63	40	-	66.7	16.4	16.4	-9	9	8	✓	-	-	7.59	GI163	SQ424	-
210C10R-F90TB27X	210	204.1	63	60	-	101.6	25.7	25.7	-9	9	10	✓	-	-	10.80	GI163	SQ425	-
260C12R-F90TB27X	260	253.4	63	60	-	101.6	25.7	25.7	-9	9	12	✓	-	-	18.21	GI163	SQ425	-

	GI163		TBMR 2707PZ..
--	-------	--	---------------

SQ421	LNK 220616	US 6013-T20P	SDR T20P-T	KU TBMR 2707	DS 01Z	KL 04	-
SQ424	LNK 220616	US 6013-T20P	SDR T20P-T	KU TBMR 2707	DS 01Z	KL 04	HS 1240
SQ425	LNK 220616	US 6013-T20P	SDR T20P-T	KU TBMR 2707	DS 01Z	KL 04	HS 1655

AC003	KS 2040	K.FMH40



TBMR 27

	BS	IC	L	M	S
	[mm]	[mm]	[mm]	[mm]	[mm]
2707	4.61	15.875	27.50	3	7.94

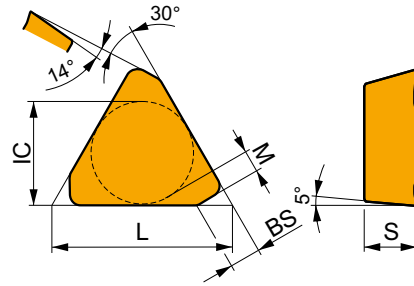

Suitability and starting values for cutting speed (vc), feed (f) and depth of cut (ap). Refer to our Machining Calculator app for further calculations.

Product	RE [mm]	P			M			K			N			S			H		
		vc [m/min]	f [mm/tooth]	ap [mm]	vc [m/min]	f [mm/tooth]	ap [mm]	vc [m/min]	f [mm/tooth]	ap [mm]	vc [m/min]	f [mm/tooth]	ap [mm]	vc [m/min]	f [mm/tooth]	ap [mm]	vc [m/min]	f [mm/tooth]	ap [mm]

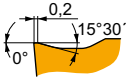

Strong design for heavy machining.

TBMR 2707PZSR	M8326	-	130	0.20	11.0	-	-	-	120	0.20	11.0	-	-	-	-	-	-	-
	M8346	-	110	0.20	11.0	65	0.20	11.0	-	-	-	-	-	-	-	-	-	-



a_s DC	5 %	10 %	15 %	20 %	25 %	30 %	40 %	50 %	60 %	70 %	75 %	80 %	90 %	100 %
	1.48	1.35	1.27	1.22	1.19	1.16	1.11	1.08	1.05	1.03	1.00	1.00	1.00	1.00
	2.20	1.60	1.35	1.20	1.10	0.95	0.85	0.75	0.85	0.95	1.00	1.00	1.00	1.00
	0.64	0.64	0.64	0.64	0.64	0.65	0.65	0.67	0.68	0.71	0.72	0.74	0.79	1.00

	TBMR 27
	-
	2.70

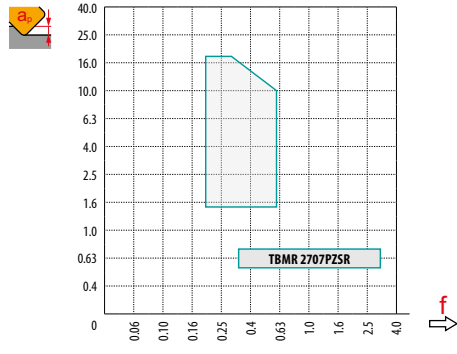

	1.5	8.0	18.0
	0.60	0.39	0.24



DORMER PRAMET



QUICK SEARCH

Easily and quickly perform a text search within any publication launched by Dormer Pramet in recent time through our library app. Download it today from your relevant app store. **Simply Reliable.**

 Download on the
App Store

 GET IT ON
Google Play

 Download on
AppGallery

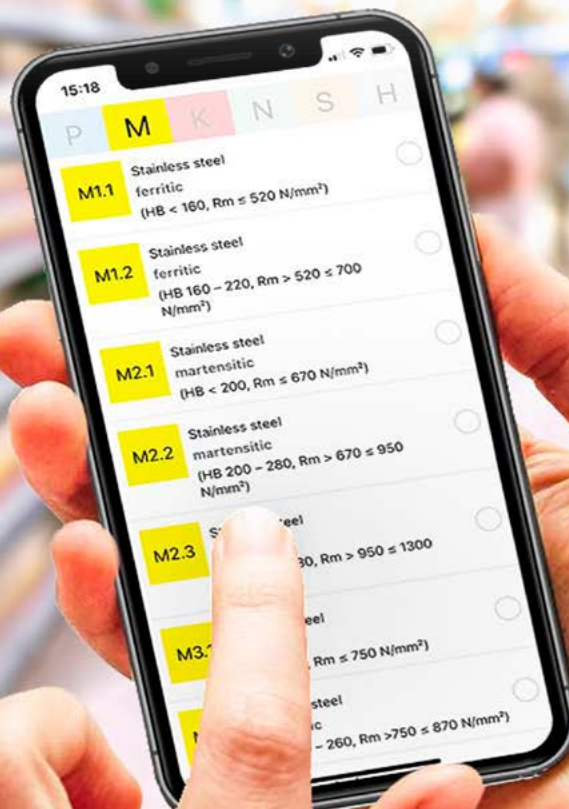



















INDEXABLE DEEP SHOULDER MILLS



INDEXABLE DEEP SHOULDER MILLS – NAVIGATOR

DEEP SHOULDER MILLING











	J(T)-SAD11E	J(T)-SAD16E	J(T)-SLSN	J(T)-SSAP	J(T)-2416					
	90°		90°		90°					
	APMX [mm]	37.0 – 56.0	APMX [mm]	40.0 – 108.0	APMX [mm]	104.0 – 134.0	APMX [mm]	58,0 – 95.0	APMX [mm]	40.0 – 63.0
	DC [mm]	25 – 50	DC [mm]	50 – 100	DC [mm]	63 – 80	DC [mm]	50 – 80	DC [mm]	20 – 40
Weldon		DC = 25 – 40 [mm]								
Morse taper		DC = 25 – 40 [mm]								
Arbor				DC = 50 – 80 [mm]						
Shell mill		DC = 50 [mm]		DC = 50 – 100 [mm]						
Page	482		488		494		498		503	
ISO	P M K N S H	P M K N S H	P M K N S H	P K	P M K N S H	P M K N				
Insert shape										
Inserts	AD 11T3	AD.. 1606	LNET 1606 SN.. 1305	APE. 150412 SPE. 1204						
No. of cutting edges	2	2	2 / 8	2 / 4						
Deep shoulder milling 	■	■	■	■	■					■
Deep slot milling 	■	■	■	■	■					▣
Face milling 	▣	▣	▣	▣	▣					▣
Plunge milling 	▣	▣	▣	▣	▣					



INDEXABLE DEEP SHOULDER MILLS – NAVIGATOR



DEEP SHOULDER MILLING

J(T)-CSD12X					
90°					
APMX [mm]	44.1 – 87.3				
DC [mm]	40 – 63				
	DC = 40 – 50 [mm]				
	DC = 50 [mm]				
	DC = 40 – 63 [mm]				
	DC = 50 – 80 [mm]				
505					
P	M	S			
					
SD.X 1205					
4					
	■				
	■				
	▣				
					



J(T)-SAD11E

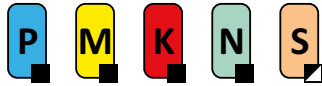

PRAMET

S



HELICAL AD11 Long Edge Mill with Internal Coolant

90° long edge end mill utilising positive ADMX 11 inserts with APMX of 36 up to 56 mm with internal coolant. Suitable for shoulder, slot, face or plunge milling. Available in Weldon, Morse taper and arbor style in Ø25 up to Ø50 mm. Body treated for longer tool life.

FORCE AD

KAPR	90°
APMX	37.0 - 56.0 mm

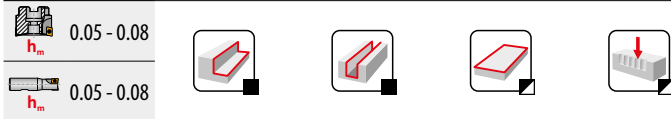
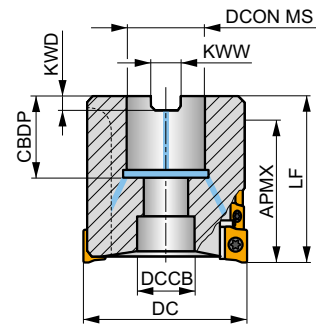
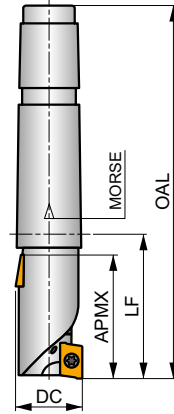
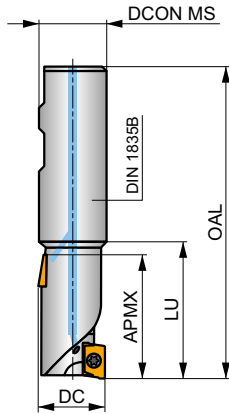
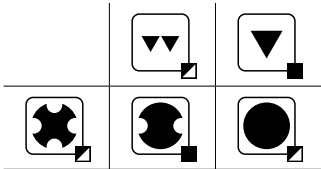
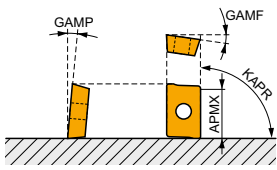

Product	DC	OAL	DCON MS	DCCB	LU	LF	APMX	CBDP	CZC MS	GAMF	GAMP	NOF							
	[mm]	[mm]	[mm]	[mm]	[mm]	[mm]	[mm]	[mm]	[mm]	[°]	[°]								
25J2R50B25-SAD11E38-C	25	106	25	-	50	-	38.00	-	-	-10.5	5	2	8	-	24100	✓	0.32	GI184	SQ210
32J2R60B32-SAD11E47-C	32	120	32	-	60	-	47.00	-	-	-9	8	2	10	-	21300	✓	0.60	GI184	SQ210
40J2R60B40-SAD11E47-C	40	130	40	-	60	-	47.00	-	-	-8.1	11	2	10	-	19100	✓	1.12	GI184	SQ210
40J3R70B32-SAD11E56-C	40	130	32	-	70	-	56.00	-	-	-8.1	11	3	18	-	19100	✓	0.76	GI184	SQ210
40J3R70B40-SAD11E56-C	40	140	40	-	70	-	56.00	-	-	-8.1	11	3	18	-	19100	✓	1.12	GI184	SQ210
25J2R55E03-SAD11E38-C	25	136	-	-	-	55	38.00	-	3	-10.5	5	2	8	-	24100	✓	0.38	GI184	SQ210
32J2R65E04-SAD11E47-C	32	167.5	-	-	-	65	47.00	-	4	-9	8	2	10	-	21300	✓	0.72	GI184	SQ210
40J3R75E04-SAD11E56-C	40	177.5	-	-	-	75	56.00	-	4	-8.1	11	3	18	-	19100	✓	0.85	GI184	SQ210
50T03R-S90AD11E37-C	50	-	22	18	-	58	37.00	21	-	-7.2	12	3	12	-	17000	✓	0.67	GI184	SQ903

GI184	ADMX 11T3..	ADEX 11T3...-FA

SQ210	US 2506-T07P	1.2	M 2.5	6.3	-	-	Flag T07P	-
SQ903	US 2506-T07P	1.2	M 2.5	6.3	D-T07P/T09P	FG-15	-	HS 1030C



ADMX 11

	W1	D1	L	S
	[mm]	[mm]	[mm]	[mm]
11T3	6.530	2.90	11.00	3.97

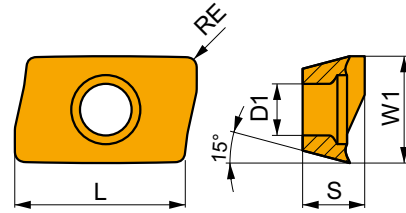

Suitability and starting values for cutting speed (vc), feed (f) and depth of cut (ap). Refer to our Machining Calculator app for further calculations.

Product	RE	P			M			K			N			S			H		
		vc	f	ap	vc	f	ap	vc	f	ap	vc	f	ap	vc	f	ap	vc	f	ap
	[mm]	[m/min]	[mm/tooth]	[mm]	[m/min]	[mm/tooth]	[mm]	[m/min]	[mm/tooth]	[mm]	[m/min]	[mm/tooth]	[mm]	[m/min]	[mm/tooth]	[mm]	[m/min]	[mm/tooth]	[mm]

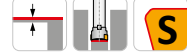
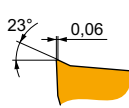
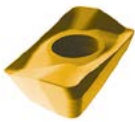

F geometry with very sharp positive design for light machining.

ADMX 11T304SR-F	8215	0.4	245	0.10	2.0	145	0.09	2.0	230	0.10	2.0	735	0.12	2.0	60	0.08	1.6	-	-	-
	M8310	0.4	270	0.10	2.0	135	0.09	2.0	255	0.10	2.0	-	-	-	-	-	-	-	-	-
	M8330	0.4	240	0.10	2.0	140	0.09	2.0	225	0.10	2.0	720	0.12	2.0	60	0.08	1.6	-	-	-
	M8340	0.4	220	0.10	2.0	130	0.09	2.0	205	0.10	2.0	-	-	-	55	0.08	1.6	-	-	-
	M9340	0.4	285	0.10	2.0	170	0.09	2.0	-	-	-	-	-	-	70	0.08	1.6	-	-	-
ADMX 11T308SR-F	8215	0.8	290	0.10	2.0	170	0.09	2.0	275	0.10	2.0	870	0.12	2.0	70	0.08	1.6	-	-	-
	M8330	0.8	285	0.10	2.0	170	0.09	2.0	270	0.10	2.0	855	0.12	2.0	70	0.08	1.6	-	-	-
	M8340	0.8	260	0.10	2.0	155	0.09	2.0	245	0.10	2.0	-	-	-	65	0.08	1.6	-	-	-
	M9340	0.8	340	0.10	2.0	200	0.09	2.0	-	-	-	-	-	-	85	0.08	1.6	-	-	-

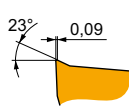
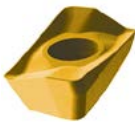

M geometry with positive design for light to medium machining.

ADMX 11T302SR-M	M8330	0.2	190	0.15	4.0	110	0.14	4.0	180	0.15	4.0	-	-	-	45	0.12	3.2	-	-	-
	M8340	0.2	170	0.15	4.0	100	0.14	4.0	160	0.15	4.0	-	-	-	40	0.12	3.2	-	-	-
ADMX 11T304SR-M	8215	0.4	205	0.15	4.0	120	0.14	4.0	190	0.15	4.0	-	-	-	50	0.12	3.2	-	-	-
	M8310	0.4	220	0.15	4.0	110	0.14	4.0	205	0.15	4.0	-	-	-	-	-	-	-	-	-
	M8330	0.4	205	0.15	4.0	120	0.14	4.0	190	0.15	4.0	-	-	-	50	0.12	3.2	-	-	-
	M8340	0.4	185	0.15	4.0	110	0.14	4.0	175	0.15	4.0	-	-	-	45	0.12	3.2	-	-	-
	M9325	0.4	255	0.15	4.0	-	-	-	240	0.15	4.0	-	-	-	-	-	-	-	-	-
	M9340	0.4	235	0.15	4.0	140	0.14	4.0	-	-	-	-	-	-	55	0.12	3.2	-	-	-
ADMX 11T308SR-M	8215	0.8	245	0.15	4.0	145	0.14	4.0	230	0.15	4.0	-	-	-	60	0.12	3.2	-	-	-
	M5315	0.8	335	0.15	4.0	-	-	-	315	0.15	4.0	-	-	-	-	-	-	-	-	-
	M8310	0.8	265	0.15	4.0	135	0.14	4.0	250	0.15	4.0	-	-	-	-	-	-	-	-	-
	M8330	0.8	245	0.15	4.0	145	0.14	4.0	230	0.15	4.0	-	-	-	60	0.12	3.2	-	-	-
	M8340	0.8	220	0.15	4.0	130	0.14	4.0	205	0.15	4.0	-	-	-	55	0.12	3.2	-	-	-
	M9315	0.8	330	0.15	4.0	-	-	-	310	0.15	4.0	-	-	-	-	-	-	-	-	-
	M9325	0.8	305	0.15	4.0	-	-	-	285	0.15	4.0	-	-	-	-	-	-	-	-	-
	M9340	0.8	275	0.15	4.0	165	0.14	4.0	-	-	-	-	-	-	65	0.12	3.2	-	-	-
ADMX 11T310SR-M	M8330	1.0	255	0.15	4.0	150	0.14	4.0	240	0.15	4.0	-	-	-	60	0.12	3.2	-	-	-
	M8340	1.0	230	0.15	4.0	135	0.14	4.0	215	0.15	4.0	-	-	-	55	0.12	3.2	-	-	-
ADMX 11T312SR-M	8215	1.2	255	0.15	4.0	150	0.14	4.0	240	0.15	4.0	-	-	-	60	0.12	3.2	-	-	-
	M8330	1.2	255	0.15	4.0	150	0.14	4.0	240	0.15	4.0	-	-	-	60	0.12	3.2	-	-	-
	M8340	1.2	230	0.15	4.0	135	0.14	4.0	215	0.15	4.0	-	-	-	55	0.12	3.2	-	-	-
ADMX 11T316SR-M	8215	1.6	270	0.15	4.0	160	0.14	4.0	255	0.15	4.0	-	-	-	65	0.12	3.2	-	-	-
	M6330	1.6	230	0.15	4.0	165	0.14	4.0	-	-	-	-	-	65	0.12	3.2	-	-	-	
	M8310	1.6	295	0.15	4.0	150	0.14	4.0	280	0.15	4.0	-	-	-	-	-	-	-	-	
	M8330	1.6	270	0.15	4.0	160	0.14	4.0	255	0.15	4.0	-	-	-	65	0.12	3.2	-	-	-
	M8340	1.6	240	0.15	4.0	140	0.14	4.0	225	0.15	4.0	-	-	-	60	0.12	3.2	-	-	-



Suitability and starting values for cutting speed (vc), feed (f) and depth of cut (ap). Refer to our Machining Calculator app for further calculations.

Product	RE (mm)	P			M			K			N			S			H		
		vc [m/min]	f [mm/tooth]	ap [mm]	vc [m/min]	f [mm/tooth]	ap [mm]	vc [m/min]	f [mm/tooth]	ap [mm]	vc [m/min]	f [mm/tooth]	ap [mm]	vc [m/min]	f [mm/tooth]	ap [mm]	vc [m/min]	f [mm/tooth]	ap [mm]

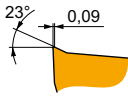
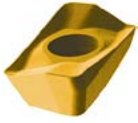

M geometry with positive design for light to medium machining.

ADMX 11T320SR-M	M6330	2.0	240	0.15	4.0	170	0.14	4.0	—	—	—	70	0.12	3.2	—	—	—
	M8330	2.0	280	0.15	4.0	165	0.14	4.0	265	0.15	4.0	70	0.12	3.2	—	—	—
	M8340	2.0	255	0.15	4.0	150	0.14	4.0	240	0.15	4.0	60	0.12	3.2	—	—	—
ADMX 11T325SR-M	M6330	2.5	240	0.15	4.0	170	0.14	4.0	—	—	—	70	0.12	3.2	—	—	—
	M8340	2.5	255	0.15	4.0	150	0.14	4.0	240	0.15	4.0	60	0.12	3.2	—	—	—
ADMX 11T330SR-M	M6330	3.0	240	0.15	4.0	170	0.14	4.0	—	—	—	70	0.12	3.2	—	—	—
	M8330	3.0	280	0.15	4.0	165	0.14	4.0	265	0.15	4.0	70	0.12	3.2	—	—	—
	M8340	3.0	255	0.15	4.0	150	0.14	4.0	240	0.15	4.0	60	0.12	3.2	—	—	—

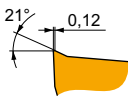
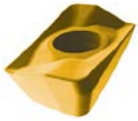

R geometry with positive design for machining conditions in less stable conditions.

ADMX 11T308PR-R	8215	0.8	230	0.18	4.0	135	0.16	4.0	215	0.18	4.0	55	0.16	3.2	45	0.15	1.0
	M5315	0.8	310	0.18	4.0	—	—	—	290	0.18	4.0	—	—	—	60	0.15	1.0
	M8310	0.8	250	0.18	4.0	125	0.16	4.0	235	0.18	4.0	—	—	—	50	0.15	1.0
	M8330	0.8	230	0.18	4.0	135	0.16	4.0	215	0.18	4.0	55	0.16	3.2	45	0.15	1.0
	M8340	0.8	210	0.18	4.0	125	0.16	4.0	195	0.18	4.0	50	0.16	3.2	—	—	—
	M9315	0.8	310	0.18	4.0	—	—	—	290	0.18	4.0	—	—	—	60	0.15	1.0
	M9325	0.8	290	0.18	4.0	—	—	—	275	0.18	4.0	—	—	—	55	0.15	1.0
ADMX 11T316PR-R	8215	1.6	255	0.18	4.0	150	0.16	4.0	240	0.18	4.0	60	0.16	3.2	50	0.15	1.0
	M8330	1.6	255	0.18	4.0	150	0.16	4.0	240	0.18	4.0	60	0.16	3.2	50	0.15	1.0
	M9325	1.6	320	0.18	4.0	—	—	—	300	0.18	4.0	—	—	—	60	0.15	1.0

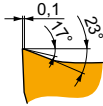

MF geometry with highly positive design for light to finish machining.

ADMX 11T304SR-MF	M6330	0.4	215	0.08	2.5	150	0.07	2.5	—	—	—	60	0.06	2.0	—	—	—
	M8340	0.4	220	0.08	2.5	130	0.07	2.5	—	—	—	55	0.06	2.0	—	—	—
ADMX 11T308SR-MF	M6330	0.8	255	0.08	2.5	180	0.07	2.5	—	—	—	75	0.06	2.0	—	—	—
	M8340	0.8	265	0.08	2.5	155	0.07	2.5	—	—	—	65	0.06	2.0	—	—	—
	M9340	0.8	360	0.08	2.5	215	0.07	2.5	—	—	—	90	0.06	2.0	—	—	—

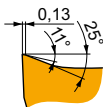

MM geometry with highly positive design for light to medium and finish to semi-rough machining.

ADMX 11T304SR-MM	M6330	0.4	185	0.14	2.5	130	0.13	2.5	—	—	—	55	0.11	2.0	—	—	—
	M8340	0.4	195	0.14	2.5	115	0.13	2.5	—	—	—	45	0.11	2.0	—	—	—
	M9340	0.4	250	0.14	2.5	150	0.13	2.5	—	—	—	60	0.11	2.0	—	—	—
ADMX 11T308SR-MM	M6330	0.8	225	0.14	2.5	155	0.13	2.5	—	—	—	65	0.11	2.0	—	—	—
	M8340	0.8	235	0.14	2.5	140	0.13	2.5	—	—	—	55	0.11	2.0	—	—	—
	M8345	0.8	190	0.14	2.5	110	0.13	2.5	—	—	—	45	0.11	2.0	—	—	—
ADMX 11T312SR-MM	M9340	0.8	300	0.14	2.5	180	0.13	2.5	—	—	—	75	0.11	2.0	—	—	—
	M6330	1.2	235	0.14	2.5	165	0.13	2.5	—	—	—	70	0.11	2.0	—	—	—
	M8340	1.2	245	0.14	2.5	145	0.13	2.5	—	—	—	60	0.11	2.0	—	—	—
M9340	1.2	315	0.14	2.5	185	0.13	2.5	—	—	—	75	0.11	2.0	—	—	—	



ADEX 11-FA

	W1	D1	L	S
	[mm]	[mm]	[mm]	[mm]
11T3	6.450	2.90	9.70	3.91

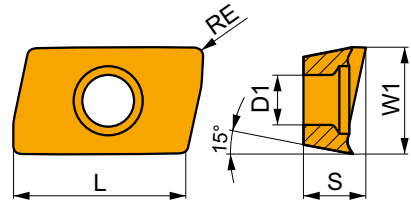

Suitability and starting values for cutting speed (vc), feed (f) and depth of cut (ap). Refer to our Machining Calculator app for further calculations.

Product	RE [mm]	P			M			K			N			S			H		
		vc [m/min]	f [mm/tooth]	ap [mm]	vc [m/min]	f [mm/tooth]	ap [mm]	vc [m/min]	f [mm/tooth]	ap [mm]	vc [m/min]	f [mm/tooth]	ap [mm]	vc [m/min]	f [mm/tooth]	ap [mm]			

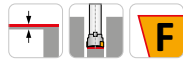
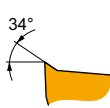

FA geometry with highly positive design for fine-finish to medium machining.

ADEX 11T304FR-FA	HF7	0.4	-	-	-	-	-	-	-	-	-	210	0.30	5.0	-	-	-	-	-	-
	M0315	0.4	-	-	-	-	-	-	-	-	-	480	0.30	5.0	-	-	-	-	-	-
ADEX 11T308FR-FA	HF7	0.8	-	-	-	-	-	-	-	-	-	240	0.30	5.0	-	-	-	-	-	-
	M0315	0.8	-	-	-	-	-	-	-	-	-	570	0.30	5.0	-	-	-	-	-	-
ADEX 11T312FR-FA	HF7	1.2	-	-	-	-	-	-	-	-	-	255	0.30	5.0	-	-	-	-	-	-
	M0315	1.2	-	-	-	-	-	-	-	-	-	600	0.30	5.0	-	-	-	-	-	-
ADEX 11T316FR-FA	HF7	1.6	-	-	-	-	-	-	-	-	-	270	0.18	5.0	-	-	-	-	-	-



a_e / DC	5 %	10 %	15 %	20 %	25 %	30 %	40 %	50 %	60 %	70 %	75 %	80 %	90 %	100 %
	0.89	0.81	0.76	0.73	0.71	0.70	0.67	0.65	0.63	0.62	0.60	0.60	0.60	0.45



	1		2.5		5		7.5		10		15		20	
	f_{min}	f_{max}	f_{min}	f_{max}	f_{min}	f_{max}	f_{min}	f_{max}	f_{min}	f_{max}	f_{min}	f_{max}	f_{min}	f_{max}
25	0.25	0.40	0.16	0.26	0.12	0.19	0.10	0.15	0.09	0.14	0.07	0.12	0.07	0.11
32	0.28	0.45	0.18	0.29	0.13	0.21	0.11	0.17	0.09	0.15	0.08	0.13	0.07	0.12
40	0.32	0.51	0.20	0.32	0.14	0.23	0.12	0.19	0.10	0.17	0.09	0.14	0.08	0.13
50	0.35	0.57	0.23	0.36	0.16	0.26	0.13	0.21	0.12	0.19	0.10	0.15	0.09	0.14

	25		32		40		50	
	f_{min}	f_{max}	f_{min}	f_{max}	f_{min}	f_{max}	f_{min}	f_{max}
25	0.08	0.13	-	-	-	-	-	-
32	0.07	0.11	0.08	0.13	-	-	-	-
40	0.07	0.12	0.07	0.11	0.08	0.13	-	-
50	0.08	0.13	0.07	0.12	0.07	0.11	0.08	0.13

	ADMX 11-F		ADMX 11-M									ADMX 11-R		ADMX 11-MF		ADMX 11-MM			ADEX 11-FA			
RE	0.4	0.8	0.2	0.4	0.8	1.0	1.2	1.6	2.0	2.5	3.0	0.8	1.6	0.4	0.8	0.4	0.8	1.2	0.4	0.8	1.2	1.6
BS	1.89	1.48	2.09	1.89	1.48	1.27	1.08	0.68	1.61	1.13	0.66	1.48	0.68	1.89	1.48	1.89	1.48	1.08	1.77	1.39	1.0	0.62



ISO					
25J2R50B25-SAD11E38-C	25	2	38	34.5	4.5
32J2R60B32-SAD11E47-C	32	2	47	43.5	
40J2R60B40-SAD11E47-C	40	2	47	43.5	
40J3R70B32-SAD11E56-C	40	3	56	52.5	
40J3R70B40-SAD11E56-C	40	3	56	52.5	
25J2R55E03-SAD11E38-C	25	2	38	34.5	
32J2R65E04-SAD11E47-C	32	2	47	43.5	
40J3R75E04-SAD11E56-C	40	3	56	52.5	
50T03R-S90AD11E37-C	50	3	37	33.5	

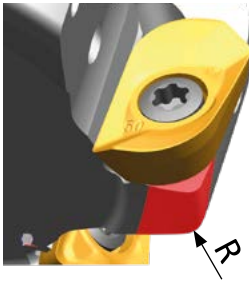

ADMX/ADEX 11	R
ADMX 11T320SR-M	1.0
ADMX 11T325SR-M	1.8
ADMX 11T330SR-M	1.8



J(T)-SAD16E



PRAMET

S



HELICAL AD16 Long Edge Mill with Internal Coolant

90° long edge end mill utilising positive AD.. 16 inserts with APMX of 40 up to 108 mm with internal coolant. Suitable for shoulder, slot, face or plunge milling. Available in arbor, DIN 69871, BT and DIN 2080 taper style, in Ø50 up to Ø100 mm, with or without differential tooth pitch. Body treated for longer tool life.

FORCE AD

KAPR	90°
APMX	40.0 - 108.0 mm

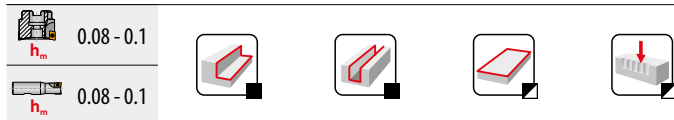
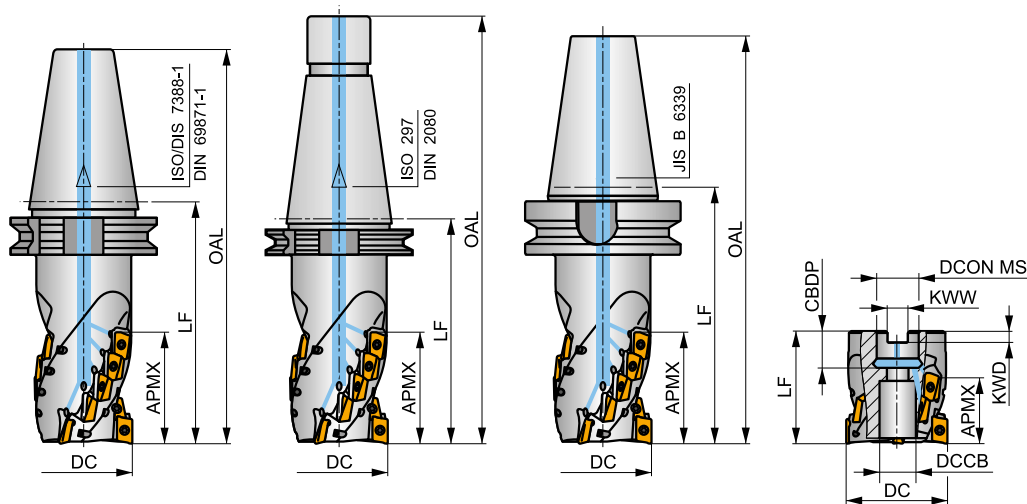
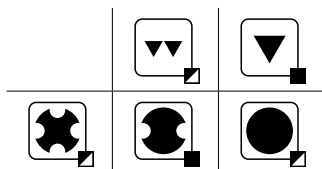
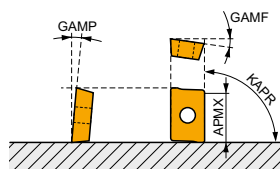

Product	DC	OAL	DCON MS	DCCB	LU	LF	APMX	CBDP	CZC MS	GAMP	GAMP	NOF						
	[mm]	[mm]	[mm]	[mm]	[mm]	[mm]	[mm]	[mm]	[mm]	[°]	[°]							
50J3R100H50-SAD16E54-C	50	202	-	-	-	100	54.00	-	50	-6	12	3	12	-	13200	✓	4.08	GI282 SQ031
50J3R140H50-SAD16E80-C	50	242	-	-	-	140	80.00	-	50	-6	12	3	18	-	13200	✓	4.38	GI282 SQ031
63J3R140H50-SAD16E68-C	63	242	-	-	-	140	68.00	-	50	-6	12	3	15	-	11700	✓	5.34	GI282 SQ031
63J3R155H50-SAD16E95-C	63	257	-	-	-	155	95.00	-	50	-6	12	3	21	-	11700	✓	5.43	GI282 SQ031
80J4R165H50-SAD16E108-C	80	257	-	-	-	165	108.00	-	50	-6	12	4	32	✓	10400	✓	7.37	GI282 SQ031
50J3R140G50-SAD16E80-C	50	267	-	-	-	140	80.00	-	50	-6	12	3	18	-	13200	✓	4.48	GI282 SQ031
63J3R155G50-SAD16E95-C	63	282	-	-	-	155	95.00	-	50	-6	12	3	21	-	11700	✓	5.52	GI282 SQ031
80J4R165G50-SAD16E108-C	80	292	-	-	-	165	108.00	-	50	-6	12	4	32	✓	10400	✓	7.51	GI282 SQ031
50J3R140X50-SAD16E68-C	50	242	-	-	-	140	68.00	-	50	-6	12	3	15	-	13200	✓	5.28	GI282 SQ031
63J3R155X50-SAD16E80-C	63	257	-	-	-	155	80.00	-	50	-6	12	3	18	-	11700	✓	6.19	GI282 SQ031
80J4R165X50-SAD16E95-C	80	267	-	-	-	165	95.00	-	50	-6	12	4	28	✓	10400	✓	7.84	GI282 SQ031
50T03R-S90AD16E40-C	50	-	22	18	-	70	40.00	21	-	-6	12	3	9	-	13200	✓	1.11	GI282 SQ913
63T04R-S90AD16E40-C	63	-	27	22	-	70	40.00	22	-	-6	12	4	12	✓	11700	✓	1.50	GI282 SQ914
63T04R-S90AD16E68-C	63	-	27	22	-	100	68.00	22	-	-6	12	4	20	✓	11700	✓	1.86	GI282 SQ914
80T04R-S90AD16E55-C	80	-	32	30	-	85	55.00	25	-	-6	12	4	16	✓	10400	✓	2.56	GI282 SQ915
80T04R-S90AD16E80-C	80	-	32	30	-	115	80.00	25	-	-6	12	4	24	✓	10400	✓	3.17	GI282 SQ915
100T05R-S90AD16E80-C	100	-	40	36	-	120	80.00	30	-	-6	12	5	30	✓	9300	✓	5.73	GI282 SQ916

GI282	ADMX 1606..	ADEX 1606..-FA	ADEX 1606..-FM



SQ031	US 4011-T15P	3.5	M 4	10.6	D-T08P/T15P	FG-15	-	
SQ913	US 4011-T15P	3.5	M 4	10.6	D-T08P/T15P	FG-15	HS 1030C	
SQ914	US 4011-T15P	3.5	M 4	10.6	D-T08P/T15P	FG-15	HS 1230C	
SQ915	US 4011-T15P	3.5	M 4	10.6	D-T08P/T15P	FG-15	HS 1630C	
SQ916	US 4011-T15P	3.5	M 4	10.6	D-T08P/T15P	FG-15	HS 2040C	

ADMX 16



	W1	D1	L	S
	[mm]	[mm]	[mm]	[mm]
1606	9.950	4.50	16.00	6.25

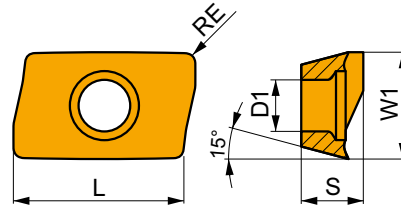

Suitability and starting values for cutting speed (vc), feed (f) and depth of cut (ap). Refer to our Machining Calculator app for further calculations.

Product	RE	P			M			K			N			S			H		
		vc	f	ap	vc	f	ap	vc	f	ap	vc	f	ap	vc	f	ap	vc	f	ap
	[mm]	[m/min]	[mm/tooth]	[mm]	[m/min]	[mm/tooth]	[mm]	[m/min]	[mm/tooth]	[mm]	[m/min]	[mm/tooth]	[mm]	[m/min]	[mm/tooth]	[mm]	[m/min]	[mm/tooth]	[mm]

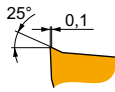

F geometry with highly positive design for light to medium machining.

ADMX 160608SR-F	8215	0.8	265	0.15	2.0	155	0.14	2.0	250	0.15	2.0	795	0.18	2.0	65	0.11	1.6	-	-	-
	M8310	0.8	285	0.15	2.0	145	0.14	2.0	270	0.15	2.0	-	-	-	-	-	-	-	-	-
	M8330	0.8	260	0.15	2.0	155	0.14	2.0	245	0.15	2.0	780	0.18	2.0	65	0.11	1.6	-	-	-
	M8340	0.8	235	0.15	2.0	140	0.14	2.0	220	0.15	2.0	-	-	-	55	0.11	1.6	-	-	-
	M9340	0.8	300	0.15	2.0	180	0.14	2.0	-	-	-	-	-	-	75	0.11	1.6	-	-	-

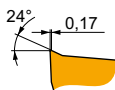
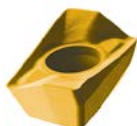

M geometry with positive design for light to medium machining.

ADMX 160604SR-M	8215	0.4	190	0.18	5.0	110	0.16	5.0	180	0.18	5.0	-	-	-	45	0.13	4.0	-	-	-	
	M8330	0.4	190	0.18	5.0	110	0.16	5.0	180	0.18	5.0	-	-	-	45	0.13	4.0	-	-	-	
	M8340	0.4	170	0.18	5.0	100	0.16	5.0	160	0.18	5.0	-	-	-	40	0.13	4.0	-	-	-	
ADMX 160608SR-M	8215	0.8	225	0.18	5.0	135	0.16	5.0	210	0.18	5.0	-	-	-	55	0.13	4.0	-	-	-	
	M5315	0.8	305	0.18	5.0	-	-	-	285	0.18	5.0	-	-	-	-	-	-	-	-	-	
	M8310	0.8	250	0.18	5.0	125	0.16	5.0	235	0.18	5.0	-	-	-	-	-	-	-	-	-	
	M8330	0.8	225	0.18	5.0	135	0.16	5.0	210	0.18	5.0	-	-	-	55	0.13	4.0	-	-	-	
	M8340	0.8	205	0.18	5.0	120	0.16	5.0	190	0.18	5.0	-	-	-	50	0.13	4.0	-	-	-	
	M9315	0.8	305	0.18	5.0	-	-	-	285	0.18	5.0	-	-	-	-	-	-	-	-	-	-
	M9325	0.8	280	0.18	5.0	-	-	-	265	0.18	5.0	-	-	-	-	-	-	-	-	-	-
M9340	0.8	255	0.18	5.0	150	0.16	5.0	-	-	-	-	-	-	60	0.13	4.0	-	-	-		
ADMX 160616SR-M	8215	1.6	250	0.18	5.0	150	0.16	5.0	235	0.18	5.0	-	-	-	60	0.13	4.0	-	-	-	
	M8310	1.6	275	0.18	5.0	140	0.16	5.0	260	0.18	5.0	-	-	-	-	-	-	-	-	-	
	M8330	1.6	250	0.18	5.0	150	0.16	5.0	235	0.18	5.0	-	-	-	60	0.13	4.0	-	-	-	
	M8340	1.6	225	0.18	5.0	135	0.16	5.0	210	0.18	5.0	-	-	-	55	0.13	4.0	-	-	-	
	M9325	1.6	310	0.18	5.0	-	-	-	290	0.18	5.0	-	-	-	-	-	-	-	-	-	
ADMX 160620SR-M	M6330	2.0	225	0.18	5.0	155	0.16	5.0	-	-	-	-	-	-	65	0.13	4.0	-	-	-	
	M8330	2.0	265	0.18	5.0	155	0.16	5.0	250	0.18	5.0	-	-	-	65	0.13	4.0	-	-	-	
	M8340	2.0	240	0.18	5.0	140	0.16	5.0	225	0.18	5.0	-	-	-	60	0.13	4.0	-	-	-	



Suitability and starting values for cutting speed (vc), feed (f) and depth of cut (ap). Refer to our Machining Calculator app for further calculations.

Product	RE [mm]	P			M			K			N			S			H		
		vc [m/min]	f [mm/tooth]	ap [mm]	vc [m/min]	f [mm/tooth]	ap [mm]	vc [m/min]	f [mm/tooth]	ap [mm]	vc [m/min]	f [mm/tooth]	ap [mm]	vc [m/min]	f [mm/tooth]	ap [mm]	vc [m/min]	f [mm/tooth]	ap [mm]

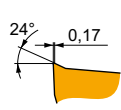

M geometry with positive design for light to medium machining.

ADMX 160630SR-M	M8330	3.0	265	0.18	5.0	155	0.16	5.0	250	0.18	5.0	–	–	–	65	0.13	4.0	–	–	–
	M8340	3.0	240	0.18	5.0	140	0.16	5.0	225	0.18	5.0	–	–	–	60	0.13	4.0	–	–	–
ADMX 160632SR-M	M6330	3.2	225	0.18	5.0	155	0.16	5.0	–	–	–	–	–	–	65	0.13	4.0	–	–	–
	M8330	3.2	265	0.18	5.0	155	0.16	5.0	250	0.18	5.0	–	–	–	65	0.13	4.0	–	–	–
	M8340	3.2	240	0.18	5.0	140	0.16	5.0	225	0.18	5.0	–	–	–	60	0.13	4.0	–	–	–
ADMX 160640SR-M	M9325	3.2	325	0.18	5.0	–	–	–	305	0.18	5.0	–	–	–	–	–	–	–	–	–
	M6330	4.0	225	0.18	5.0	155	0.16	5.0	–	–	–	–	–	–	65	0.13	4.0	–	–	–
	M8330	4.0	265	0.18	5.0	155	0.16	5.0	250	0.18	5.0	–	–	–	65	0.13	4.0	–	–	–
ADMX 160650SR-M	M8340	4.0	240	0.18	5.0	140	0.16	5.0	225	0.18	5.0	–	–	–	60	0.13	4.0	–	–	–
	M8330	5.0	265	0.18	5.0	155	0.16	5.0	250	0.18	5.0	–	–	–	65	0.13	4.0	–	–	–
	M8340	5.0	240	0.18	5.0	140	0.16	5.0	225	0.18	5.0	–	–	–	60	0.13	4.0	–	–	–

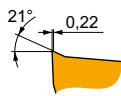

R geometry with positive design for medium to less stable machining conditions.

ADMX 160608PR-R	8215	0.8	205	0.25	6.0	120	0.23	6.0	190	0.25	6.0	–	–	–	50	0.20	4.8	40	0.15	1.0	
	M5315	0.8	260	0.25	6.0	–	–	–	245	0.25	6.0	–	–	–	–	–	–	50	0.15	1.0	
	M8310	0.8	220	0.25	6.0	110	0.23	6.0	205	0.25	6.0	–	–	–	–	–	–	40	0.15	1.0	
	M8330	0.8	205	0.25	6.0	120	0.23	6.0	190	0.25	6.0	–	–	–	50	0.20	4.8	40	0.15	1.0	
	M8340	0.8	190	0.25	6.0	110	0.23	6.0	180	0.25	6.0	–	–	–	45	0.20	4.8	–	–	–	
	M9315	0.8	265	0.25	6.0	–	–	–	250	0.25	6.0	–	–	–	–	–	–	–	50	0.15	1.0
ADMX 160616PR-R	M9325	0.8	250	0.25	6.0	–	–	–	235	0.25	6.0	–	–	–	–	–	–	–	50	0.15	1.0
	M5315	1.6	290	0.25	6.0	–	–	–	275	0.25	6.0	–	–	–	–	–	–	–	55	0.15	1.0
	M8330	1.6	225	0.25	6.0	135	0.23	6.0	210	0.25	6.0	–	–	–	55	0.20	4.8	45	0.15	1.0	
	M8340	1.6	210	0.25	6.0	125	0.23	6.0	195	0.25	6.0	–	–	–	50	0.20	4.8	–	–	–	
	M9315	1.6	295	0.25	6.0	–	–	–	280	0.25	6.0	–	–	–	–	–	–	–	55	0.15	1.0
M9325	1.6	275	0.25	6.0	–	–	–	260	0.25	6.0	–	–	–	–	–	–	–	55	0.15	1.0	

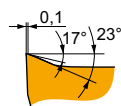

MF geometry with highly positive design for finish machining.

ADMX 160608SR-MF	M6330	0.8	215	0.08	4.0	150	0.07	4.0	–	–	–	–	–	–	60	0.06	3.2	–	–	–
	M8340	0.8	225	0.08	4.0	135	0.07	4.0	–	–	–	–	–	–	55	0.06	3.2	–	–	–
	M9340	0.8	305	0.08	4.0	180	0.07	4.0	–	–	–	–	–	–	75	0.06	3.2	–	–	–

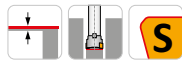
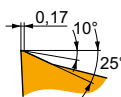

MM geometry with highly positive design for light to medium machining.

ADMX 160604SR-MM	M6330	0.4	145	0.18	4.0	105	0.16	4.0	–	–	–	–	–	–	40	0.14	3.2	–	–	–
	M8340	0.4	160	0.18	4.0	95	0.16	4.0	–	–	–	–	–	–	40	0.14	3.2	–	–	–
ADMX 160608SR-MM	M6330	0.8	175	0.18	4.0	125	0.16	4.0	–	–	–	–	–	–	50	0.14	3.2	–	–	–
	M8340	0.8	190	0.18	4.0	110	0.16	4.0	–	–	–	–	–	–	45	0.14	3.2	–	–	–
	M8345	0.8	150	0.18	4.0	90	0.16	4.0	–	–	–	–	–	–	35	0.14	3.2	–	–	–
	M9340	0.8	235	0.18	4.0	140	0.16	4.0	–	–	–	–	–	–	55	0.14	3.2	–	–	–
ADMX 160616SR-MM	M6330	1.6	195	0.18	4.0	140	0.16	4.0	–	–	–	–	–	–	55	0.14	3.2	–	–	–
	M8340	1.6	210	0.18	4.0	125	0.16	4.0	–	–	–	–	–	–	50	0.14	3.2	–	–	–
	M8345	1.6	165	0.18	4.0	95	0.16	4.0	–	–	–	–	–	–	40	0.14	3.2	–	–	–
	M9340	1.6	260	0.18	4.0	155	0.16	4.0	–	–	–	–	–	–	65	0.14	3.2	–	–	–



ADEX 16



	W1	D1	L	S
	[mm]	[mm]	[mm]	[mm]
1606	9.950	4.50	16.00	6.25

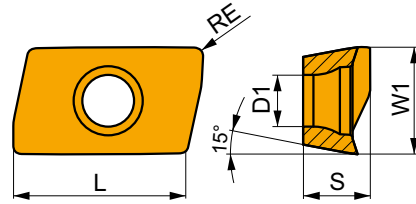

Suitability and starting values for cutting speed (vc), feed (f) and depth of cut (ap). Refer to our Machining Calculator app for further calculations.

Product	RE	P			M			K			N			S			H		
		vc	f	ap	vc	f	ap	vc	f	ap	vc	f	ap	vc	f	ap	vc	f	ap
	[mm]	[m/min]	[mm/tooth]	[mm]	[m/min]	[mm/tooth]	[mm]	[m/min]	[mm/tooth]	[mm]	[m/min]	[mm/tooth]	[mm]	[m/min]	[mm/tooth]	[mm]	[m/min]	[mm/tooth]	[mm]

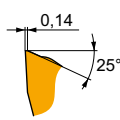

FM geometry with highly positive design for medium machining.

ADEX 160608SR-FM	8215	0.8	■	260	0.16	2.0	■	155	0.14	2.0	■	245	0.16	2.0	■	65	0.11	1.6	■	—	—	—
	M8330	0.8	■	255	0.16	2.0	■	150	0.14	2.0	■	240	0.16	2.0	■	60	0.11	1.6	■	—	—	—
	M8340	0.8	■	235	0.16	2.0	■	140	0.14	2.0	■	220	0.16	2.0	■	55	0.11	1.6	■	—	—	—

ADEX 16-FA



	W1	D1	L	S
	[mm]	[mm]	[mm]	[mm]
1606	9.950	4.50	16.00	6.17

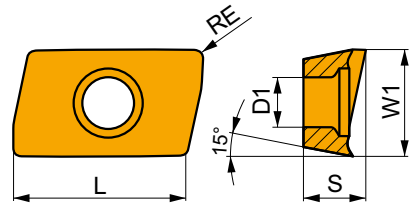

Suitability and starting values for cutting speed (vc), feed (f) and depth of cut (ap). Refer to our Machining Calculator app for further calculations.

Product	RE	P			M			K			N			S			H		
		vc	f	ap	vc	f	ap	vc	f	ap	vc	f	ap	vc	f	ap	vc	f	ap
	[mm]	[m/min]	[mm/tooth]	[mm]	[m/min]	[mm/tooth]	[mm]	[m/min]	[mm/tooth]	[mm]	[m/min]	[mm/tooth]	[mm]	[m/min]	[mm/tooth]	[mm]	[m/min]	[mm/tooth]	[mm]

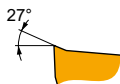

FA geometry with highly positive design for fine-finish to medium machining.

ADEX 160604FR-FA	HF7	0.4	■	—	—	—	■	—	—	—	■	195	0.28	6.0	■	—	—	—	■	—	—	—
	M0315	0.4	■	—	—	—	■	—	—	—	■	480	0.28	6.0	■	—	—	—	■	—	—	—
ADEX 160608FR-FA	HF7	0.8	■	—	—	—	■	—	—	—	■	240	0.28	6.0	■	—	—	—	■	—	—	—
	M0315	0.8	■	—	—	—	■	—	—	—	■	570	0.28	6.0	■	—	—	—	■	—	—	—
ADEX 160616FR-FA	HF7	1.6	■	—	—	—	■	—	—	—	■	255	0.28	6.0	■	—	—	—	■	—	—	—
	M0315	1.6	■	—	—	—	■	—	—	—	■	630	0.28	6.0	■	—	—	—	■	—	—	—
ADEX 160630FR-FA	HF7	3.0	■	—	—	—	■	—	—	—	■	270	0.28	6.0	■	—	—	—	■	—	—	—



a_e DC	5 %	10 %	15 %	20 %	25 %	30 %	40 %	50 %	60 %	70 %	75 %	80 %	90 %	100 %
	0.89	0.81	0.76	0.73	0.71	0.70	0.66	0.65	0.63	0.62	0.60	0.60	0.60	0.45







	1		2.5		5		7.5		10		15		20	
	f_{min}	f_{max}	f_{min}	f_{max}	f_{min}	f_{max}	f_{min}	f_{max}	f_{min}	f_{max}	f_{min}	f_{max}	f_{min}	f_{max}
50	0.57	0.71	0.36	0.45	0.26	0.32	0.21	0.27	0.19	0.23	0.15	0.19	0.14	0.17
63	0.64	0.80	0.40	0.51	0.29	0.36	0.24	0.30	0.21	0.26	0.17	0.21	0.15	0.19
80	0.72	0.90	0.45	0.57	0.32	0.40	0.27	0.33	0.23	0.29	0.19	0.24	0.17	0.21
100	0.80	1.00	0.51	0.64	0.36	0.45	0.30	0.37	0.26	0.32	0.21	0.27	0.19	0.23

	25		32		40		50		63		80		100	
	f_{min}	f_{max}	f_{min}	f_{max}	f_{min}	f_{max}	f_{min}	f_{max}	f_{min}	f_{max}	f_{min}	f_{max}	f_{min}	f_{max}
50	0.13	0.16	0.12	0.14	0.11	0.14	0.13	0.16	-	-	-	-	-	-
63	0.14	0.17	0.12	0.16	0.12	0.15	0.11	0.14	0.13	0.16	-	-	-	-
80	0.15	0.19	0.14	0.17	0.13	0.16	0.12	0.15	0.11	0.14	0.13	0.16	-	-
100	0.17	0.21	0.15	0.19	0.14	0.17	0.13	0.16	0.12	0.15	0.11	0.14	0.13	0.16

	ADMX 16-F	ADEX 16-FM	ADMX 16-M								ADMX 16-R	
	0.8	0.8	0.4	0.8	1.6	2.0	3.0	3.2	4.0	5.0	0.8	1.6
	2.99	2.18	3.39	2.99	1.62	1.23	0.28	0.09	2.69	1.52	2.99	1.62

	ADMX 16-MF	ADMX 16-MM			ADEX 16-FA			
	0.8	0.4	0.8	1.6	0.4	0.8	1.6	3.0
	2.99	3.39	2.99	1.62	2.84	2.44	1.65	0.69



ISO				
50J3R100H50-SAD16E54-C	50	3	54	50.5
50J3R140H50-SAD16E80-C	50	3	80	76.5
63J3R140H50-SAD16E68-C	63	3	68	64.5
63J3R155H50-SAD16E95-C	63	3	95	91.5
80J4R165H50-SAD16E108-C	80	4	108	104.5
50J3R140G50-SAD16E80-C	50	3	80	76.5
63J3R155G50-SAD16E95-C	63	3	95	91.5
80J4R165G50-SAD16E108-C	80	4	108	104.5
50J3R140X50-SAD16E68-C	50	3	68	64.5
63J3R155X50-SAD16E80-C	63	3	80	76.5
80J4R165X50-SAD16E95-C	80	4	95	91.5
50T03R-S90AD16E40-C	50	3	40	36.5
63T04R-S90AD16E40-C	63	4	40	36.5
63T04R-S90AD16E68-C	63	4	68	64.5
80T04R-S90AD16E55-C	80	4	55	51.5
80T04R-S90AD16E80-C	80	4	80	76.5
100T05R-S90AD16E80-C	100	5	80	76.5

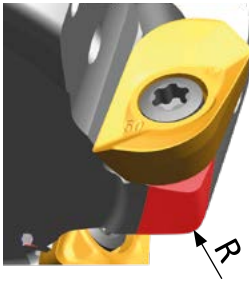
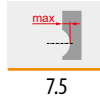

ADMX/ADEX 16	R
ADMX 160630SR-M	2.5
ADMX 160632SR-M	2.5
ADMX 160640SR-M	4.0
ADMX 160650SR-M	4.5



J(T)-SLSN



PRAMET



ROUGH SN Long Edge Mill for Heavy Milling with Internal Coolant

90° long edge end mill utilising LNET 16 and SN.. 13 inserts with APMX of 104 up to 134 mm. Body has exchangeable end piece. Suitable for shoulder, slot, face and plunge milling. Available in DIN 69871, BT and DIN 2080 50 taper style, in Ø63 and Ø80 mm. Body treated for longer tool life.

ROUGH SN

KAPR	90°
APMX	104.0 - 134.0 mm

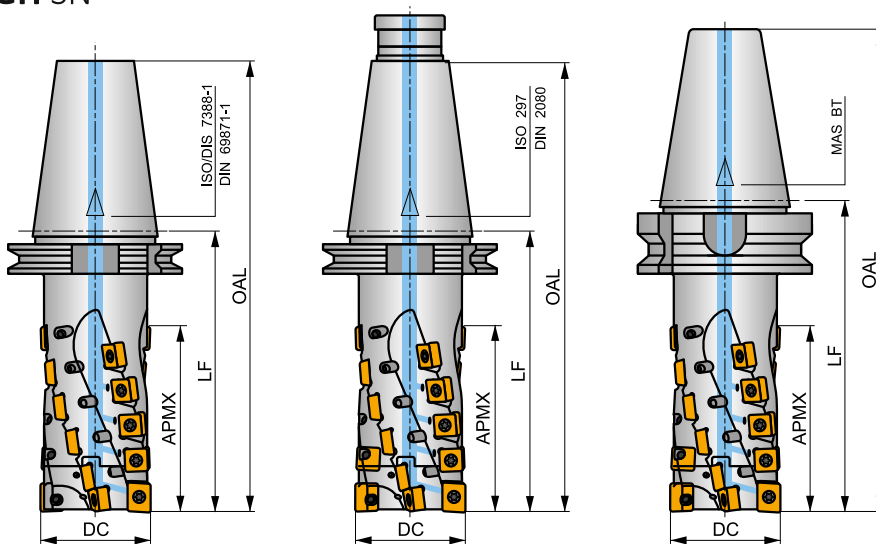
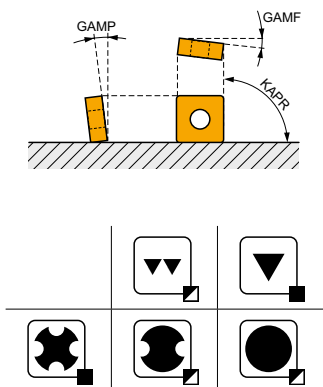

h_m 0.08 - 0.22



Product	DC	OAL	APMX	LF	GAMF	GAMP	CZCMS	NOF	LN	SN	max.	kg	GI209	SQ934		
	[mm]	[mm]	[mm]	[mm]	[°]	[°]										
63J2R155H50-SLSN104-C	63	257	104.00	155	-9	-10	50	4	2	20	-	8500	✓	5.03	GI209	SQ934
80J2R190H50-SLSN134-C	80	292	134.00	190	-9	-10	50	4	2	26	-	7500	✓	7.45	GI209	SQ935
63J2R155G50-SLSN104-C	63	282	104.00	155	-9	-10	50	4	2	20	-	8500	✓	5.20	GI209	SQ934
80J2R190G50-SLSN134-C	80	317	134.00	190	-9	-10	50	4	2	26	-	7500	✓	7.40	GI209	SQ935
63J2R175X50-SLSN104-C	63	277	104.00	175	-9	-10	50	4	2	20	-	8500	✓	6.10	GI209	SQ934
80J2R210X50-SLSN134-C	80	312	134.00	210	-9	-10	50	4	2	26	-	7500	✓	8.50	GI209	SQ935

GI209	LNET 1606..	SN.. 1305..

SQ934	EH6326-SL-C	HS 1230	HXK 10	US 45012-T20P	5.0	M 5	12	SDRT20P-T
SQ935	EH8036-SL-C	HS 1640	HXK 14	US 45012-T20P	5.0	M 5	12	SDRT20P-T



LNET 16

	W1	D1	L	S
	[mm]	[mm]	[mm]	[mm]
1606	13.200	5.90	16.40	6.38

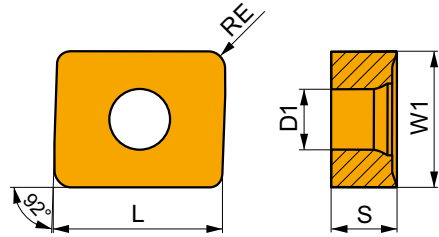

Suitability and starting values for cutting speed (vc), feed (f) and depth of cut (ap). Refer to our Machining Calculator app for further calculations.

Product	RE	P			M			K			N			S			H		
		vc	f	ap	vc	f	ap	vc	f	ap	vc	f	ap	vc	f	ap	vc	f	ap
	[mm]	[m/min]	[mm/tooth]	[mm]	[m/min]	[mm/tooth]	[mm]	[m/min]	[mm/tooth]	[mm]	[m/min]	[mm/tooth]	[mm]	[m/min]	[mm/tooth]	[mm]	[m/min]	[mm/tooth]	[mm]

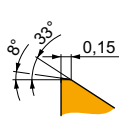

M geometry with highly positive design for medium machining.

LNET 160616SR-M	M8330	1.6	■	110	0.15	15.0	■	–	–	–	■	100	0.15	15.0	■	–	–	–	■	–	–	–
	M8340	1.6	■	105	0.15	15.0	■	–	–	–	■	95	0.15	15.0	■	–	–	–	■	–	–	–

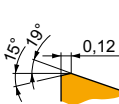

R geometry with highly positive design for medium machining.

LNET 160616SR-R	M8330	1.6	■	100	0.15	15.0	■	–	–	–	■	95	0.15	15.0	■	–	–	–	■	–	–	–
	M8340	1.6	■	95	0.15	15.0	■	–	–	–	■	90	0.15	15.0	■	–	–	–	■	–	–	–

SNGX 13

	IC	D1	S
	[mm]	[mm]	[mm]
1305	13.200	5.90	5.96

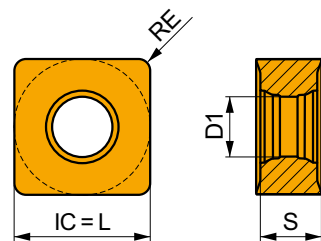

Suitability and starting values for cutting speed (vc), feed (f) and depth of cut (ap). Refer to our Machining Calculator app for further calculations.

Product	RE	P			M			K			N			S			H		
		vc	f	ap	vc	f	ap	vc	f	ap	vc	f	ap	vc	f	ap	vc	f	ap
	[mm]	[m/min]	[mm/tooth]	[mm]	[m/min]	[mm/tooth]	[mm]	[m/min]	[mm/tooth]	[mm]	[m/min]	[mm/tooth]	[mm]	[m/min]	[mm/tooth]	[mm]	[m/min]	[mm/tooth]	[mm]

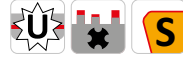
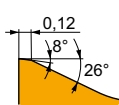

M geometry with positive design for light machining.

SNGX 130512SN-M	M8330	1.2	■	105	0.15	12.0	■	–	–	–	■	95	0.15	12.0	■	–	–	–	■	–	–	–
	M8340	1.2	■	105	0.15	12.0	■	–	–	–	■	95	0.15	12.0	■	–	–	–	■	–	–	–



Suitability and starting values for cutting speed (vc), feed (f) and depth of cut (ap). Refer to our Machining Calculator app for further calculations.

Product	RE [mm]	P			M			K			N			S			H		
		vc [m/min]	f [mm/tooth]	ap [mm]	vc [m/min]	f [mm/tooth]	ap [mm]	vc [m/min]	f [mm/tooth]	ap [mm]	vc [m/min]	f [mm/tooth]	ap [mm]	vc [m/min]	f [mm/tooth]	ap [mm]	vc [m/min]	f [mm/tooth]	ap [mm]

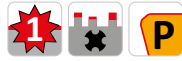
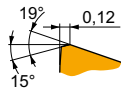

R geometry with positive design for rough machining and unstable conditions.

SNGX 130512PN-R	M8330	1.2	95	0.15	12.0	–	–	–	90	0.15	12.0	–	–	–	–	–	–	–
	M8340	1.2	95	0.15	12.0	–	–	–	90	0.15	12.0	–	–	–	–	–	–	–

SNET 13

PRAMET

	IC [mm]	D1 [mm]	L [mm]	S [mm]
1305	13.200	5.90	13.20	6.33

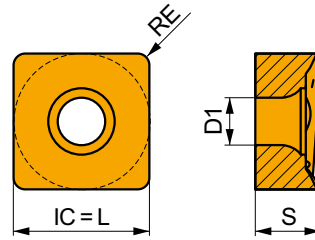

Suitability and starting values for cutting speed (vc), feed (f) and depth of cut (ap). Refer to our Machining Calculator app for further calculations.

Product	RE [mm]	P			M			K			N			S			H		
		vc [m/min]	f [mm/tooth]	ap [mm]	vc [m/min]	f [mm/tooth]	ap [mm]	vc [m/min]	f [mm/tooth]	ap [mm]	vc [m/min]	f [mm/tooth]	ap [mm]	vc [m/min]	f [mm/tooth]	ap [mm]	vc [m/min]	f [mm/tooth]	ap [mm]

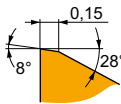

M geometry with positive design for light to medium machining.

SNET 130512SR-M	M8330	1.2	105	0.15	12.0	–	–	–	95	0.15	12.0	–	–	–	–	–	–	–
	M8340	1.2	105	0.15	12.0	–	–	–	95	0.15	12.0	–	–	–	–	–	–	–



a_s DC	5%	10%	15%	20%	25%	30%	40%	50%	60%	70%	75%	80%	90%	100%
	1.48	1.35	1.27	1.22	1.19	1.16	1.11	1.08	1.05	1.03	1.00	1.00	1.00	1.00



	1	2.5	5	7.5	10	15	20
	f_{min} ↔	f_{min} ↔	f_{min} ↔	f_{min} ↔	f_{min} ↔	f_{min} ↔	f_{min} ↔
	f_{max} →	f_{max} →	f_{max} →	f_{max} →	f_{max} →	f_{max} →	f_{max} →
63	0.64	1.75	0.40	1.11	0.29	0.79	0.24
80	0.72	1.97	0.45	1.25	0.32	0.89	0.27

	25	32	40	50	63	80
	f_{min} ↔	f_{min} ↔	f_{min} ↔	f_{min} ↔	f_{min} ↔	f_{min} ↔
	f_{max} →	f_{max} →	f_{max} →	f_{max} →	f_{max} →	f_{max} →
63	0.14	0.38	0.12	0.34	0.12	0.32
80	0.15	0.42	0.14	0.38	0.13	0.35

	LNET 16-M	LNET 16-R	SNGX 13-M	SNGX 13-R	SNET 13-M
	1.6	1.6	1.2	1.2	1.2
	-	-	-	-	-



ISO			
63J2R155H50-SLSN104-C	63	2+2	104
80J2R190H50-SLSN134-C	80	2+2	134
63J2R155G50-SLSN104-C	63	2+2	104
80J2R190G50-SLSN134-C	80	2+2	134
63J2R175X50-SLSN104-C	63	2+2	104
80J2R210X50-SLSN134-C	80	2+2	134



J(T)-SSAP



PRAMET

S



Long Edge End Mill for Medium Milling for AP.. 15 and SP.. 12 Inserts

90° long edge end mill utilising AP.. 15 and SP.. 12 inserts with APMX of 58 up to 95 mm. Body has exchangeable end piece. Suitable for shoulder, slot, face and plunge milling. Available in DIN 69871 and DIN 2080 50 taper style, in Ø50 up to Ø80 mm. Body treated for longer tool life.

KAPR	90°
APMX	58.0 - 95.0 mm

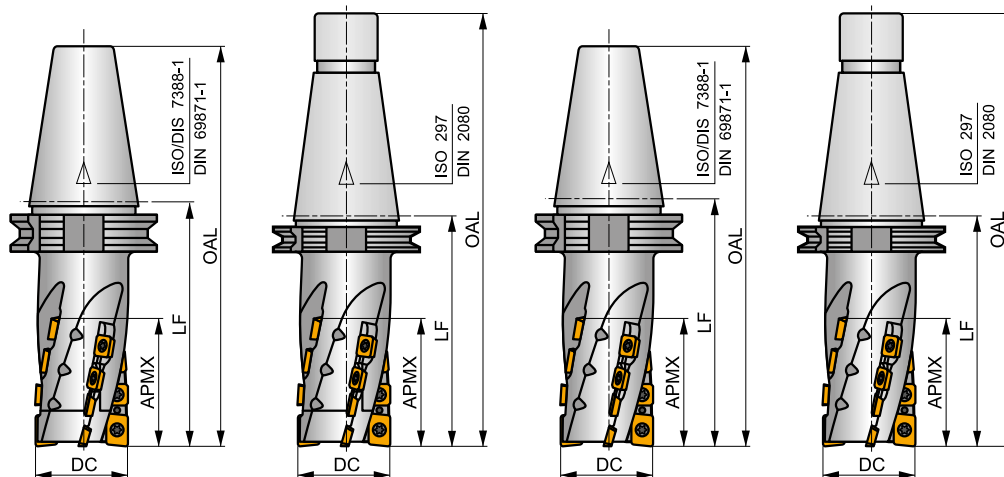
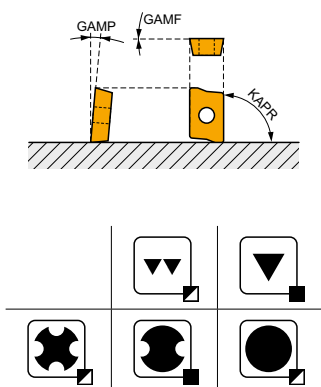

h_m 0.07 - 0.1



Product	DC	OAL	APMX	LF	GAMF	GAMP	CZCMS	NOF	AP	SP	max.	kg	GI128	SQ941
	[mm]	[mm]	[mm]	[mm]	[°]	[°]								
50J4R110H50-SSAP37+21	50	212	58.00	110	0	7	50	4	2	12	9500	3.65	GI128	SQ942
50J4R128H50-SSAP55+21	50	230	76.00	128	0	7	50	4	2	16	9500	3.80	GI128	SQ942
63J4R150H50-SSAP74+21	63	252	95.00	150	0	7	50	4	2	20	8500	4.50	GI128	SQ943
50J4R106X50-SSAP37+21	50	233	58.00	106	0	7	50	4	2	12	9500	3.50	GI128	SQ942
50J4R124X50-SSAP55+21	50	251	76.00	124	0	7	50	4	2	16	9500	4.43	GI128	SQ942
63J4R146X50-SSAP74+21	63	273	95.00	146	0	7	50	4	2	20	8500	4.75	GI128	SQ943
50J4R110H50-SSAP58-A	50	212	58.00	110	0	7	50	4	2	12	9500	3.50	GI128	SQ941
50J4R128H50-SSAP76-A	50	230	76.00	128	0	7	50	4	2	16	9500	3.80	GI128	SQ941
63J4R150H50-SSAP95-A	63	252	95.00	150	0	7	50	4	2	20	8500	4.50	GI128	SQ941
80J6R155H50-SSAP95-A	80	257	95.00	155	0	7	50	6	3	30	7500	6.30	GI128	SQ941
50J4R106X50-SSAP58-A	50	233	58.00	106	0	7	50	4	2	12	9500	3.70	GI128	SQ941
50J4R124X50-SSAP76-A	50	251	76.00	124	0	7	50	4	2	16	9500	3.80	GI128	SQ941
63J4R146X50-SSAP95-A	63	273	95.00	146	0	7	50	4	2	20	8500	4.50	GI128	SQ941
80J6R151X50-SSAP95-A	80	275	95.00	151	0	7	50	6	3	30	7500	6.20	GI128	SQ941

GI128	APE. 1504..	SPE. 1204..

SQ941	SQ942	SQ943	US 4511-T20	5.0	M 4.5	11	SDR T20-T
-	P50X21	SR 25	HXX 6	US 4511-T20	5.0	M 4.5	SDR T20-T
-	P63X21	SR 26	HXX 8	US 4511-T20	5.0	M 4.5	SDR T20-T



APET 15

	W1	D1	L	S
	[mm]	[mm]	[mm]	[mm]
1504	12.700	5.50	15.90	4.76

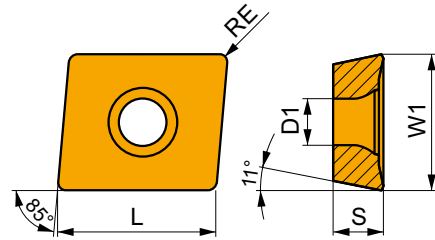

Suitability and starting values for cutting speed (vc), feed (f) and depth of cut (ap). Refer to our Machining Calculator app for further calculations.

Product	RE	P			M			K			N			S			H		
		vc	f	ap	vc	f	ap	vc	f	ap	vc	f	ap	vc	f	ap	vc	f	ap
	[mm]	[m/min]	[mm/tooth]	[mm]	[m/min]	[mm/tooth]	[mm]	[m/min]	[mm/tooth]	[mm]	[m/min]	[mm/tooth]	[mm]	[m/min]	[mm/tooth]	[mm]	[m/min]	[mm/tooth]	[mm]

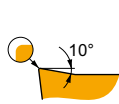
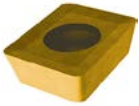

EN edge preparation, positive geometry for light to medium machining.

APET 150412EN	M8330	1.2	225	0.20	12.0	135	0.18	12.0	210	0.20	12.0	-	-	-	55	0.14	9.6	-	-	-
----------------------	--------------	-----	-----	------	------	-----	------	------	-----	------	------	---	---	---	----	------	-----	---	---	---

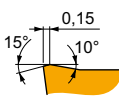
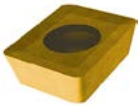

SN edge preparation, positive geometry for medium to heavy machining.

APET 150412SN	M8330	1.2	215	0.25	12.0	125	0.23	12.0	200	0.25	12.0	-	-	-	50	0.25	9.6	-	-	-
	M8340	1.2	190	0.25	12.0	110	0.23	12.0	180	0.25	12.0	-	-	-	45	0.25	9.6	-	-	-

APEW 15

	W1	D1	L	M	S
	[mm]	[mm]	[mm]	[mm]	[mm]
1504	12.700	5.50	15.90	4	4.76

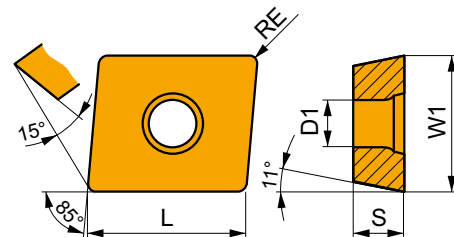

Suitability and starting values for cutting speed (vc), feed (f) and depth of cut (ap). Refer to our Machining Calculator app for further calculations.

Product	RE	P			M			K			N			S			H		
		vc	f	ap	vc	f	ap	vc	f	ap	vc	f	ap	vc	f	ap	vc	f	ap
	[mm]	[m/min]	[mm/tooth]	[mm]	[m/min]	[mm/tooth]	[mm]	[m/min]	[mm/tooth]	[mm]	[m/min]	[mm/tooth]	[mm]	[m/min]	[mm/tooth]	[mm]	[m/min]	[mm/tooth]	[mm]

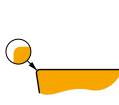
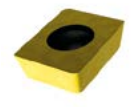

ER edge preparation, zero rake angle geometry for light to medium machining.

APEW 150412ER	M8330	1.2	200	0.20	12.0	-	-	-	190	0.20	12.0	-	-	-	-	-	-	40	0.15	1.0
----------------------	--------------	-----	-----	------	------	---	---	---	-----	------	------	---	---	---	---	---	---	----	------	-----

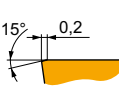
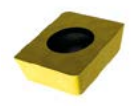

SR edge preparation, zero rake angle geometry for medium to heavy machining.

APEW 150412SR	M8330	1.2	200	0.20	12.0	-	-	-	190	0.20	12.0	-	-	-	-	-	-	40	0.15	1.0
	M8340	1.2	180	0.20	12.0	-	-	-	170	0.20	12.0	-	-	-	-	-	-	-	-	-



SPET 12



	IC	D1	L	M	S
	[mm]	[mm]	[mm]	[mm]	[mm]
1204	12.700	5.50	12.70	2	4.76

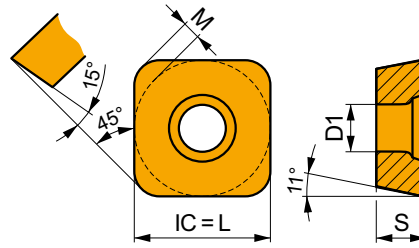

Suitability and starting values for cutting speed (vc), feed (f) and depth of cut (ap). Refer to our Machining Calculator app for further calculations.

Product	RE	P			M			K			N			S			H		
		vc	f	ap	vc	f	ap	vc	f	ap	vc	f	ap	vc	f	ap	vc	f	ap
	[mm]	[m/min]	[mm/tooth]	[mm]	[m/min]	[mm/tooth]	[mm]	[m/min]	[mm/tooth]	[mm]	[m/min]	[mm/tooth]	[mm]	[m/min]	[mm/tooth]	[mm]	[m/min]	[mm/tooth]	[mm]

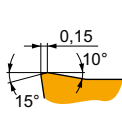
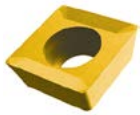

S edge preparation, positive general purpose geometry.

SPET 120408S	M8330	0.8	215	0.20	12.0	125	0.18	12.0	200	0.20	12.0	-	-	-	50	0.18	9.6	-	-	-
	M8340	0.8	190	0.20	12.0	110	0.18	12.0	180	0.20	12.0	-	-	-	45	0.18	9.6	-	-	-

SPET 12 AD



	IC	D1	L	M	S
	[mm]	[mm]	[mm]	[mm]	[mm]
1204	12.700	5.50	12.70	2	4.76

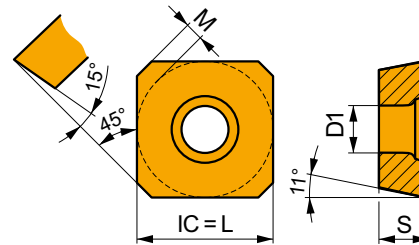

Suitability and starting values for cutting speed (vc), feed (f) and depth of cut (ap). Refer to our Machining Calculator app for further calculations.

Product	RE	P			M			K			N			S			H		
		vc	f	ap	vc	f	ap	vc	f	ap	vc	f	ap	vc	f	ap	vc	f	ap
	[mm]	[m/min]	[mm/tooth]	[mm]	[m/min]	[mm/tooth]	[mm]	[m/min]	[mm/tooth]	[mm]	[m/min]	[mm/tooth]	[mm]	[m/min]	[mm/tooth]	[mm]	[m/min]	[mm/tooth]	[mm]

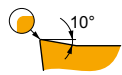
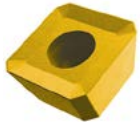

ADEN edge preparation, positive geometry for light to medium machining.

SPET 1204ADEN	M8330	-	245	0.20	12.0	145	0.18	12.0	230	0.20	12.0	-	-	-	60	0.14	9.6	-	-	-
	M8340	-	220	0.20	12.0	130	0.18	12.0	205	0.20	12.0	-	-	-	55	0.14	9.6	-	-	-

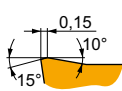
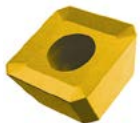

ADSN edge preparation, positive geometry for medium machining.

SPET 1204ADSN	M8330	-	245	0.20	12.0	145	0.18	12.0	230	0.20	12.0	-	-	-	60	0.14	9.6	-	-	-
	M8340	-	220	0.20	12.0	130	0.18	12.0	205	0.20	12.0	-	-	-	55	0.14	9.6	-	-	-



SPEW 12 AD

	IC	D1	L	M	S
	[mm]	[mm]	[mm]	[mm]	[mm]
1204	12.700	5.50	12.70	2	4.76

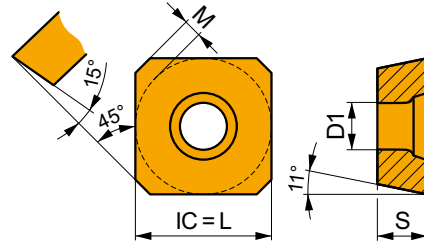

Suitability and starting values for cutting speed (vc), feed (f) and depth of cut (ap). Refer to our Machining Calculator app for further calculations.

Product	RE	P			M			K			N			S			H		
		vc	f	ap	vc	f	ap	vc	f	ap	vc	f	ap	vc	f	ap	vc	f	ap
	[mm]	[m/min]	[mm/tooth]	[mm]	[m/min]	[mm/tooth]	[mm]	[m/min]	[mm/tooth]	[mm]	[m/min]	[mm/tooth]	[mm]	[m/min]	[mm/tooth]	[mm]	[m/min]	[mm/tooth]	[mm]

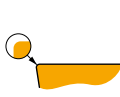
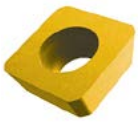

ADEN edge preparation, zero rake angle geometry for light to medium machining.

SPEW 1204ADEN	M8330	-	220	0.20	12.0	-	-	-	205	0.20	12.0	-	-	-	-	-	-	40	0.15	1.0
	M8340	-	200	0.20	12.0	-	-	-	190	0.20	12.0	-	-	-	-	-	-	-	-	-

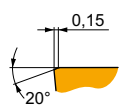
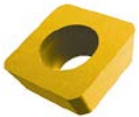

ADSN edge preparation, zero rake angle geometry for medium machining.

SPEW 1204ADSN	M8330	-	220	0.20	12.0	-	-	-	205	0.20	12.0	-	-	-	-	-	-	40	0.15	1.0
	M8340	-	200	0.20	12.0	-	-	-	190	0.20	12.0	-	-	-	-	-	-	-	-	-



a_e / DC	5 %	10 %	15 %	20 %	25 %	30 %	40 %	50 %	60 %	70 %	75 %	80 %	90 %	100 %
	0.89	0.81	0.76	0.73	0.71	0.70	0.67	0.65	0.63	0.62	0.60	0.60	0.60	0.45



	1	2.5	5	7.5	10	15	20
	f_{min} f_{max}	f_{min} f_{max}	f_{min} f_{max}	f_{min} f_{max}	f_{min} f_{max}	f_{min} f_{max}	f_{min} f_{max}
50	0.50 0.71	0.32 0.45	0.23 0.32	0.19 0.27	0.16 0.23	0.14 0.19	0.12 0.17
63	0.56 0.80	0.35 0.51	0.25 0.36	0.21 0.30	0.18 0.26	0.15 0.21	0.13 0.19
80	0.63 0.90	0.40 0.57	0.28 0.40	0.23 0.33	0.20 0.29	0.17 0.24	0.15 0.21

	25	32	40	50	63	80
	f_{min} f_{max}	f_{min} f_{max}	f_{min} f_{max}	f_{min} f_{max}	f_{min} f_{max}	f_{min} f_{max}
50	0.11 0.16	0.10 0.14	0.10 0.14	0.11 0.16	- -	- -
63	0.12 0.17	0.11 0.16	0.10 0.15	0.10 0.14	0.11 0.16	- -
80	0.13 0.19	0.12 0.17	0.11 0.16	0.10 0.15	0.10 0.14	0.11 0.16

	APET 15	APEW 15	SPET 12	SPET 12AD	SPEW 12AD
	1.2	1.2	0.8	-	-
	-	-	-	-	-



ISO				
50J4R110H50-SSAP37+21	50	2+2	58	55.6
50J4R128H50-SSAP55+21	50	2+2	76	73.6
63J4R150H50-SSAP74+21	63	2+2	95	92.6
50J4R106X50-SSAP37+21	50	2+2	58	55.6
50J4R124X50-SSAP55+21	50	2+2	76	73.6
63J4R146X50-SSAP74+21	63	2+2	95	92.6
50J4R110H50-SSAP58-A	50	2+2	58	55.6
50J4R128H50-SSAP76-A	50	2+2	76	73.6
63J4R150H50-SSAP95-A	63	2+2	95	92.6
80J6R155H50-SSAP95-A	80	3+3	95	92.6
50J4R106X50-SSAP58-A	50	2+2	58	55.6
50J4R124X50-SSAP76-A	50	2+2	76	73.6
63J4R146X50-SSAP95-A	63	2+2	95	92.6
80J6R151X50-SSAP95-A	80	3+3	95	92.6



J(T)-2416

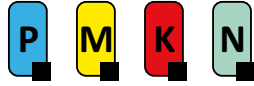

Long Edge Mill with Brazed Solid Carbide Helical Tips

90° long edge mill with helically brazed carbide tips and APMX of 40 up to 63 mm. Suitable for shoulder, slot and face milling. Available in morse taper 4 and 6, in Ø20 up to Ø40 mm. Body treated for longer tool life.

KAPR	90°
APMX	40.0 - 63.0 mm

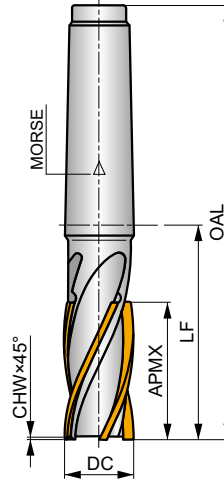
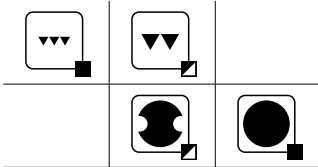
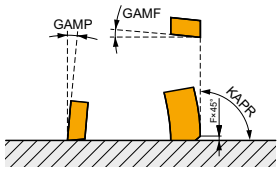

h_m 0.02 - 0.04



Product	DC	OAL	APMX	LF	CHW	CZCMS	NOF				kg		
	[mm]	[mm]	[mm]	[mm]	[mm]								
2416-20R-E3-P	20	146	40.00	65	0.5	3	4	-	-	-	0.37	-	-
2416-25R-E3-P	25	160	50.00	79	0.5	3	4	-	-	-	0.40	-	-
2416-32R-E4-P	32	180	50.00	78	0.5	4	4	-	-	-	0.80	-	-
2416-40R-E4-P	40	200	63.00	98	0.8	4	6	-	-	-	1.19	-	-



ISO		f_{\min}	f_{\max}	P30
P		0.03	0.08	149
		0.03	0.07	133
		0.03	0.06	115
M		0.03	0.08	88
		0.03	0.07	79
		0.03	0.06	70
K		0.03	0.08	142
		0.03	0.07	126
		0.03	0.06	110
N		0.03	0.08	374
		0.03	0.07	333
		0.03	0.06	290



a_e / DC	5 %	10 %	15 %	20 %	25 %	30 %	40 %	50 %	60 %	70 %	75 %	80 %	90 %	100 %
	1.48	1.35	1.27	1.22	1.19	1.16	1.11	1.08	1.05	1.03	1.00	1.00	1.00	1.00
	2.20	1.60	1.35	1.20	1.10	0.95	0.85	0.75	0.85	0.95	1.00	1.00	1.00	1.00
	0.64	0.64	0.64	0.64	0.64	0.65	0.65	0.67	0.68	0.71	0.72	0.74	0.79	1.00



ISO				
2416-20R-E3-P	20	4	40	40
2416-25R-E3-P	25	4	50	50
2416-32R-E4-P	32	4	50	50
2416-40R-E4-P	40	6	63	63



	0.5		1		2		3		4		5		8	
	f_{\min}	f_{\max}	f_{\min}	f_{\max}	f_{\min}	f_{\max}	f_{\min}	f_{\max}	f_{\min}	f_{\max}	f_{\min}	f_{\max}	f_{\min}	f_{\max}
20	0.14	0.25	0.10	0.18	0.07	0.13	0.06	0.11	0.05	0.09	0.05	0.08	0.04	0.07
25	0.16	0.28	0.11	0.20	0.08	0.14	0.07	0.12	0.06	0.10	0.05	0.09	0.04	0.08
32	0.18	0.32	0.13	0.23	0.09	0.16	0.07	0.13	0.07	0.12	0.06	0.10	0.05	0.08
40	0.20	0.36	0.14	0.25	0.10	0.18	0.08	0.15	0.07	0.13	0.07	0.12	0.05	0.09

	10		12		16		20		25		32		40	
	f_{\min}	f_{\max}	f_{\min}	f_{\max}	f_{\min}	f_{\max}	f_{\min}	f_{\max}	f_{\min}	f_{\max}	f_{\min}	f_{\max}	f_{\min}	f_{\max}
20	0.04	0.06	0.03	0.06	0.03	0.06	0.04	0.06	-	-	-	-	-	-
25	0.04	0.07	0.04	0.06	0.03	0.06	0.03	0.06	0.04	0.06	-	-	-	-
32	0.04	0.08	0.04	0.07	0.04	0.06	0.03	0.06	0.03	0.06	0.04	0.06	-	-
40	0.05	0.08	0.04	0.08	0.04	0.07	0.04	0.06	0.03	0.06	0.03	0.06	0.04	0.06



J(T)-CSD12X



PRAMET



MULTISIDE SD Long Edge Mill

90° long edge end mill utilising positive SD.. 12 inserts with APMX of 44.1 up to 87.3 mm. Suitable for shoulder, slot or face milling. Available in arbor, PSC, Morse or DIN 69871 taper style, in Ø40 up to Ø80 mm. Body treated for longer tool life.

MULTISIDE SD

KAPR	90°
APMX	44.1 - 87.3 mm

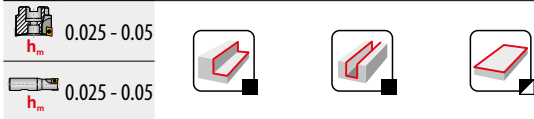
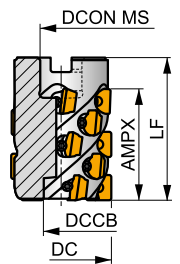
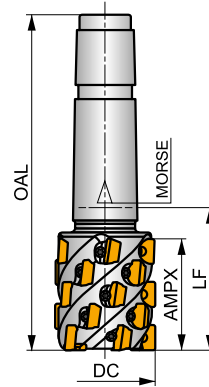
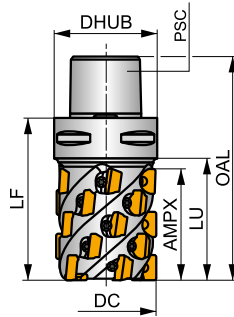
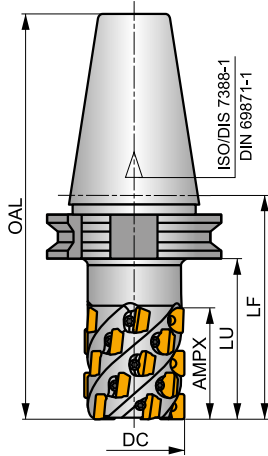
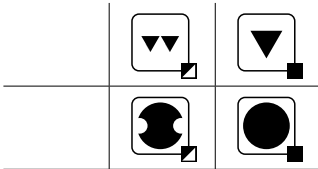
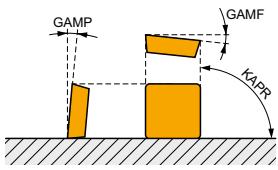

Product	DC	OAL	DCON MS	DCCB	LU	LF	APMX	GAMF	GAMP	CZC MS	NOF	ISO/DIS 7388-1	ISO 6462 DIN 8030	max.	kg	GI271	SQ091	
	[mm]	[mm]	[mm]	[mm]	[mm]	[mm]	[mm]	[°]	[°]									
40J4R090H40-CSD12X44	40	158.4	-	-	70	90	44.10	-5	8	40	4	16	-	4000	-	1.16	GI271	SQ091
50J5R100H50-CSD12X55	50	201.7	-	-	80	100	54.90	-5	8	50	5	25	-	3200	-	4.20	GI271	SQ091
63J6R110H50-CSD12X66	63	211.7	-	-	90	110	65.70	-5	8	50	6	36	-	2500	-	4.90	GI271	SQ091
40J4R080XC5-CSD12X44	40	110	-	-	59	80	44.10	-5	8	C5	4	16	-	4000	-	1.06	GI271	SQ091
50J5R080XC5-CSD12X55	50	110	-	-	59	80	54.90	-5	8	C5	5	25	-	3200	-	1.24	GI271	SQ091
50J5R065E04-CSD12X55	50	167.5	-	-	-	65	54.90	-5	8	4	5	25	-	3200	-	1.34	GI271	SQ091
50T05R-C90SD12X55	50	-	22	18	-	78	54.90	-5	8	-	5	25	-	3200	-	0.95	GI271	SQ923
63T06R-C90SD12X66	63	-	27	22	-	90	65.70	-5	8	-	6	36	-	2500	-	1.72	GI271	SQ924
80T08R-C90SD12X88	80	-	40	36	-	115	87.30	-5	8	-	8	64	-	2000	-	3.20	GI271	SQ925

GI271	SDGX 1205..	SDMX 1205..
-------	-------------	-------------

Icon	Part Number	Nm	Thread	Length	Tool	Tool	Tool
Icon 1	SQ091	US 63511D-T15P	3.0	M 3.5	11	D-T08P/T15P	FG-15
Icon 2	SQ923	US 63511D-T15P	3.0	M 3.5	11	D-T08P/T15P	FG-15
Icon 3	SQ924	US 63511D-T15P	3.0	M 3.5	11	D-T08P/T15P	FG-15
Icon 4	SQ925	US 63511D-T15P	3.0	M 3.5	11	D-T08P/T15P	FG-15



SDGX 12



	IC	L	S	S1
	[mm]	[mm]	[mm]	[mm]
1205	12.700	12.70	5.56	6.35

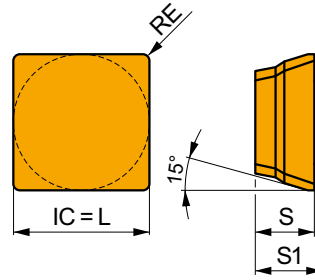

Suitability and starting values for cutting speed (vc), feed (f) and depth of cut (ap). Refer to our Machining Calculator app for further calculations.

Product	RE	P			M			K			N			S			H		
		vc	f	ap	vc	f	ap	vc	f	ap	vc	f	ap	vc	f	ap	vc	f	ap
	[mm]	[m/min]	[mm/tooth]	[mm]	[m/min]	[mm/tooth]	[mm]	[m/min]	[mm/tooth]	[mm]	[m/min]	[mm/tooth]	[mm]	[m/min]	[mm/tooth]	[mm]	[m/min]	[mm/tooth]	[mm]

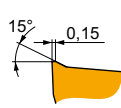

FM geometry with positive design for light to medium heavy machining.

SDGX 120508EN-FM	M8330	0.8	220	0.15	12.0	130	0.14	12.0	-	-	-	-	-	-	55	0.11	9.6	-	-	-
	M8345	0.8	155	0.15	12.0	90	0.14	12.0	-	-	-	-	-	-	35	0.11	9.6	-	-	-

SDMX 12



	IC	L	S	S1
	[mm]	[mm]	[mm]	[mm]
1205	12.700	12.70	5.56	6.35

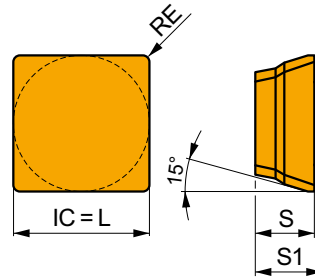

Suitability and starting values for cutting speed (vc), feed (f) and depth of cut (ap). Refer to our Machining Calculator app for further calculations.

Product	RE	P			M			K			N			S			H		
		vc	f	ap	vc	f	ap	vc	f	ap	vc	f	ap	vc	f	ap	vc	f	ap
	[mm]	[m/min]	[mm/tooth]	[mm]	[m/min]	[mm/tooth]	[mm]	[m/min]	[mm/tooth]	[mm]	[m/min]	[mm/tooth]	[mm]	[m/min]	[mm/tooth]	[mm]	[m/min]	[mm/tooth]	[mm]

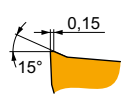
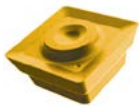

M geometry with positive design for light to heavy machining.

SDMX 120508EN-M	M8330	0.8	220	0.15	12.0	130	0.14	12.0	-	-	-	-	-	-	55	0.11	9.6	-	-	-
	M8345	0.8	155	0.15	12.0	90	0.14	12.0	-	-	-	-	-	-	35	0.11	9.6	-	-	-



a_e DC	5%	10%	15%	20%	25%	30%	40%	50%	60%	70%	75%	80%	90%	100%
	0.89	0.81	0.76	0.73	0.71	0.70	0.66	0.65	0.63	0.62	0.60	0.60	0.60	0.45



	1	2.5	5	7.5	10	15	20							
	f_{min} ↔	f_{max} →	f_{min} ↔	f_{max} →	f_{min} ↔	f_{max} →	f_{min} ↔	f_{max} →	f_{min} ↔	f_{max} →	f_{min} ↔	f_{max} →	f_{min} ↔	f_{max} →
40	0.16	0.32	0.10	0.20	0.07	0.14	0.06	0.12	0.05	0.10	0.04	0.09	0.04	0.08
50	0.18	0.35	0.11	0.23	0.08	0.16	0.07	0.13	0.06	0.12	0.05	0.10	0.04	0.09
63	0.20	0.40	0.13	0.25	0.09	0.18	0.07	0.15	0.06	0.13	0.05	0.11	0.05	0.09
80	0.22	0.45	0.14	0.28	0.10	0.20	0.08	0.17	0.07	0.14	0.06	0.12	0.05	0.10

	25	32	40	50	63	80						
	f_{min} ↔	f_{max} →	f_{min} ↔	f_{max} →	f_{min} ↔	f_{max} →	f_{min} ↔	f_{max} →	f_{min} ↔	f_{max} →	f_{min} ↔	f_{max} →
40	0.04	0.07	0.03	0.07	0.04	0.08	-	-	-	-	-	-
50	0.04	0.08	0.04	0.07	0.03	0.07	0.04	0.08	-	-	-	-
63	0.04	0.09	0.04	0.08	0.04	0.07	0.03	0.07	0.04	0.08	-	-
80	0.05	0.09	0.04	0.09	0.04	0.08	0.04	0.07	0.03	0.07	0.04	0.08

	SDGX 12-FM	SDMX 12-M
	0.8	0.8
	2.99	2.99



ISO				
40J4R090H40-CSD12X44	40	4	44.1	42.5
50J5R100H50-CSD12X55	50	5	54.9	53.3
63J6R110H50-CSD12X66	63	6	65.7	64.1
80J8R130H50-CSD12X88	80	8	87.3	85.7
40J4R080XC5-CSD12X44	40	4	44.1	42.5
50J5R080XC5-CSD12X55	50	5	54.9	53.3
63J6R095XC6-CSD12X66	63	6	65.7	64.1
50J5R065E04-CSD12X55	50	5	54.9	53.3
50T05R-C90SD12X55	50	5	54.9	53.3
63T06R-C90SD12X66	63	6	65.7	64.1
80T08R-C90SD12X88	80	8	87.3	85.7

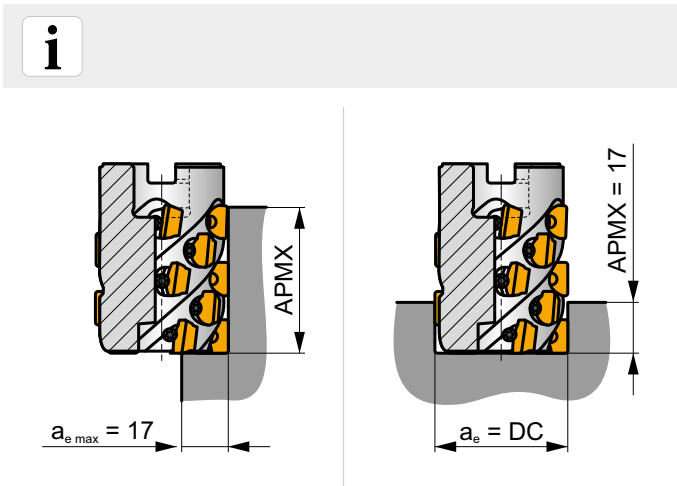









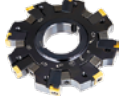

INDEXABLE SLOT MILLS



INDEXABLE SLOT MILLS – NAVIGATOR

SLOT MILLING

	S90SN		S90CN(XN)				
	90°		90°				
	APMX [mm]	4.0 – 14.0	APMX [mm]	14.0 – 30.5			
	DC [mm]	80 – 200	DC [mm]	125 – 315			
Disc		DC = 80 – 200 [mm]		DC = 125 – 315 [mm]			
Shell mill			DC = 63 – 160 [mm]			DC = 125 – 200 [mm]	
Page	510		516				
ISO	P	M	K	P	M	K	
Insert shape							
Inserts	SNHQ 11 SNHQ 12		CNHQ 1005 XNHQ 1205 XNHQ 1606				
No. of cutting edges	4		2				
Deep slot milling		■	■				
Deep shoulder milling		▣	▣				
Face milling		▣	▣				
Rear face milling		▣	▣				



S90SN



PRAMET

S



Side and Face Disk Milling Cutter

90° side and face cutter utilising SNHQ 11, 12 inserts with APMX (slotting depth) of 10.5 up to 62 mm. Suitable for shoulder, slot, rear side and face milling. Available in arbor or stub arbor style, in range Ø63 up to Ø200 mm. Body treated for longer tool life.

KAPR	90°
CW	4.0 - 14.0 mm

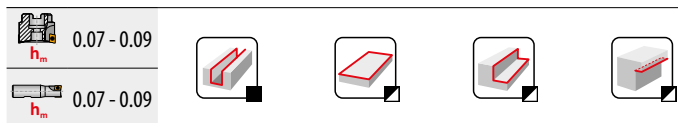
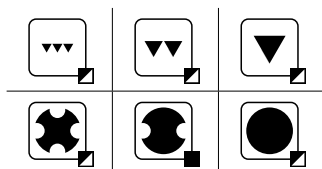
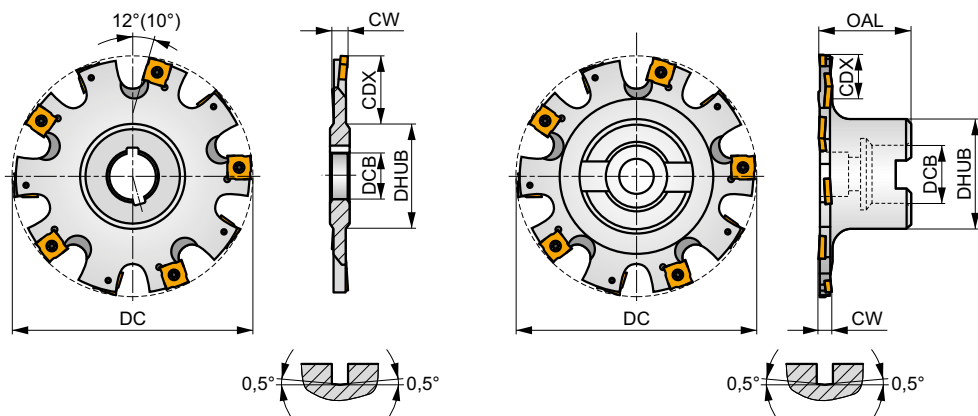
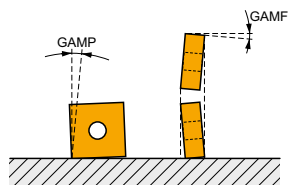

Product	DC	OAL	DCB	DHUB	CDX	CW	χ	GAMF	GAMP									
	[mm]	[mm]	[mm]	[mm]	[mm]	[mm]	[°]	[°]	[°]									
80F8N-S90SN11N4	80	-	27	42	16	4.00	-	2.5	-0.5	8	-	12300	-	0.23	GI151	DI011	-	-
80F8N-S90SN11N5	80	-	27	42	16	5.00	-	2.5	-0.5	8	-	12300	-	0.22	GI152	DI019	-	-
80F8N-S90SN12N6	80	-	27	42	16	6.00	-	2.5	-0.5	8	-	8400	-	0.25	GI153	DI012	-	-
80F8N-S90SN12N8	80	-	27	42	16	8.00	-	2.5	-0.5	8	-	8400	-	0.28	GI157	DI013	-	-
100G10N-S90SN12N6	100	-	32	48	24	6.00	-	2.5	-0.5	10	-	7500	-	0.43	GI153	DI012	-	-
100G10N-S90SN12N8	100	-	32	48	24	8.00	-	2.5	-0.5	10	-	7500	-	0.42	GI157	DI013	-	-
100G10N-S90SN12N10	100	-	32	48	24	10.00	-	2.5	-0.5	10	-	7500	-	0.46	GI154	DI014	-	-
100G10N-S90SN12N12	100	-	32	48	24	12.00	-	2.5	-0.5	10	-	7500	-	0.66	GI158	DI015	-	-
125H12N-S90SN12N6	125	-	40	58	31	6.00	-	2.5	-0.5	12	-	6700	-	0.62	GI153	DI012	-	-
125H12N-S90SN12N8	125	-	40	58	31	8.00	-	2.5	-0.5	12	-	6700	-	0.73	GI157	DI013	-	-
125H12N-S90SN12N10	125	-	40	58	31	10.00	-	2.5	-0.5	12	-	6700	-	0.66	GI154	DI014	-	-
125H12N-S90SN12N12	125	-	40	58	31	12.00	-	2.5	-0.5	12	-	6700	-	0.76	GI158	DI015	-	-
160H16N-S90SN12N6	160	-	40	58	43	6.00	-	2.5	-0.5	16	-	5900	-	0.86	GI153	DI012	-	-
160H16N-S90SN12N8	160	-	40	58	43	8.00	-	2.5	-0.5	16	-	5900	-	1.10	GI157	DI013	-	-
160H16N-S90SN12N10	160	-	40	58	43	10.00	-	2.5	-0.5	16	-	5900	-	1.14	GI154	DI014	-	-
160H16N-S90SN12N12	160	-	40	58	43	12.00	-	2.5	-0.5	16	-	5900	-	1.30	GI158	DI015	-	-
160H15N-S90SN12N14	160	-	40	58	43	14.00	-	2.5	-0.5	15	-	5900	-	1.40	GI158	DI015	-	-
200J18N-S90SN12N6	200	-	50	72	62	6.00	-	2.5	-0.5	18	-	5300	-	1.40	GI153	DI012	-	-
200J18N-S90SN12N8	200	-	50	72	62	8.00	-	2.5	-0.5	18	-	5300	-	1.78	GI157	DI013	-	-
200J18N-S90SN12N10	200	-	50	72	62	10.00	-	2.5	-0.5	18	-	5300	-	1.89	GI154	DI014	-	-
200J18N-S90SN12N12	200	-	50	72	62	12.00	-	2.5	-0.5	18	-	5300	-	2.23	GI158	DI015	-	-
200J18N-S90SN12N14	200	-	50	72	62	14.00	-	2.5	-0.5	18	-	5300	-	2.67	GI158	DI015	-	-
63A03R-S90SN11N4	63	40	16	34	10.5	4.00	3	2.5	-0.5	6	-	13900	-	0.39	GI151	DI021	-	-
63A03R-S90SN11N5	63	40	16	34	10.5	5.00	3	2.5	-0.5	6	-	13900	-	0.36	GI152	DI021	-	-
63A03R-S90SN12N6	63	40	16	34	10.5	6.00	3	2.5	-0.5	6	-	9500	-	0.37	GI153	DI022	-	-
80A04R-S90SN11N5	80	40	22	40	17.5	5.00	4	2.5	-0.5	8	-	12300	-	0.48	GI152	DI023	-	-
80A04R-S90SN12N6	80	40	22	40	17.5	6.00	4	2.5	-0.5	8	-	8400	-	0.50	GI153	DI024	-	-



Product	DC	OAL	DCB	DHUB	CDX	CW		GAMF	GAMP								
	[mm]	[mm]	[mm]	[mm]	[mm]	[mm]		[°]	[°]								
100A05R-S90SN12N6	100	50	27	48	23.5	6.00	5	2.5	-0.5	10	-	7500	-	0.86	GI153	DI025	-
125B06R-S90SN12N6	125	50	40	56	24	6.00	6	2.5	-0.5	12	-	6700	-	1.20	GI153	DI012	AC003
160B08R-S90SN12N10	160	50	40	70	41	10.00	8	2.5	-0.5	16	-	5900	-	2.03	GI154	DI014	-

GI151	SNHQ 1102..
GI152	SNHQ 1103..
GI153	SNHQ 1203..
GI154	SNHQ 1205..
GI157	SNHQ 1204..
GI158	SNHQ 1207

DI011	US 3504-T09P	3.0	M 3.5	4	D-T07P/T09P	FG-15	-	-
DI012	US 70	5.0	M 4	5	D-T07/T15	FG-15	-	-
DI013	US 71	5.0	M 4	7	D-T07/T15	FG-15	-	-
DI014	US 72	5.0	M 4	9	D-T07/T15	FG-15	-	-
DI015	US 73	5.0	M 4	11	D-T07/T15	FG-15	-	-
DI019	US 3505-T09P	3.0	M 3.5	5	D-T07P/T09P	FG-15	HS 0830	-
DI021	US 3504-T09P	3.0	M 3.5	4	D-T07P/T09P	FG-15	HS 0830	-
DI022	US 70	5.0	M 4	5	D-T07/T15	FG-15	HS 0830	-
DI023	US 3505-T09P	3.0	M 3.5	5	D-T07P/T09P	FG-15	HS 1030	-
DI024	US 70	5.0	M 4	5	D-T07/T15	FG-15	HS 1030	-
DI025	US 70	5.0	M 4	5	D-T07/T15	FG-15	HS 1230	-

AC003	KS 2040	K.FMH40



SNHQ AZ



	IC [mm]	D1 [mm]	W1 [mm]
1102	11.000	4.30	2.300
1103	11.000	4.30	2.700
1203	12.700	5.00	3.200
1204	12.700	5.00	4.500
1205	12.700	5.00	5.400
1207	12.700	5.00	7.000

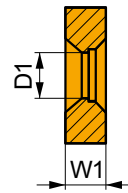
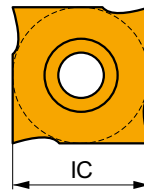

Suitability and starting values for cutting speed (vc), feed (f) and depth of cut (ap). Refer to our Machining Calculator app for further calculations.

Product	RE [mm]	P			M			K			N			S			H		
		vc [m/min]	f [mm/tooth]	ap [mm]	vc [m/min]	f [mm/tooth]	ap [mm]	vc [m/min]	f [mm/tooth]	ap [mm]	vc [m/min]	f [mm/tooth]	ap [mm]	vc [m/min]	f [mm/tooth]	ap [mm]	vc [m/min]	f [mm/tooth]	ap [mm]

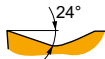
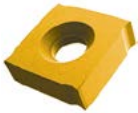

EN geometry with special design for slot milling.

SNHQ 1203AZEN	8215	-	415	0.10	-	245	0.10	-	390	0.10	-	-	-	-	-	-	-	-
	M8340	-	370	0.10	-	220	0.10	-	350	0.10	-	-	-	-	-	-	-	-
SNHQ 1204AZEN	8215	-	405	0.10	-	240	0.10	-	380	0.10	-	-	-	-	-	-	-	-
	M8340	-	355	0.10	-	210	0.10	-	335	0.10	-	-	-	-	-	-	-	-
SNHQ 1205AZEN	8215	-	390	0.10	-	230	0.10	-	370	0.10	-	-	-	-	-	-	-	-
	M8340	-	345	0.10	-	205	0.10	-	325	0.10	-	-	-	-	-	-	-	-
SNHQ 1207AZEN	8215	-	380	0.10	-	225	0.10	-	360	0.10	-	-	-	-	-	-	-	-
	M8340	-	335	0.10	-	200	0.10	-	315	0.10	-	-	-	-	-	-	-	-

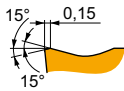
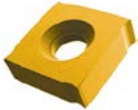

TN geometry with special design for slot milling.

SNHQ 1102AZTN	M8330	-	365	0.20	-	215	0.18	-	345	0.20	-	-	-	-	-	-	-	-
	M8340	-	335	0.20	-	200	0.18	-	315	0.20	-	-	-	-	-	-	-	-
SNHQ 1103AZTN	M8330	-	345	0.20	-	205	0.18	-	325	0.20	-	-	-	-	-	-	-	-
	M8340	-	315	0.20	-	185	0.18	-	295	0.20	-	-	-	-	-	-	-	-

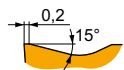
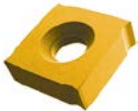

TN geometry with special design for slot milling.

SNHQ 1203AZTN	M8330	-	345	0.20	-	205	0.18	-	325	0.20	-	-	-	-	-	-	-	-
	M8340	-	315	0.20	-	185	0.18	-	295	0.20	-	-	-	-	-	-	-	-
SNHQ 1204AZTN	M8330	-	335	0.20	-	200	0.20	-	315	0.20	-	-	-	-	-	-	-	-
	M8340	-	300	0.20	-	180	0.20	-	285	0.20	-	-	-	-	-	-	-	-
SNHQ 1205AZTN	M8330	-	330	0.20	-	195	0.20	-	310	0.20	-	-	-	-	-	-	-	-
	M8340	-	295	0.20	-	175	0.20	-	280	0.20	-	-	-	-	-	-	-	-
SNHQ 1207AZTN	M8330	-	320	0.20	-	190	0.20	-	300	0.20	-	-	-	-	-	-	-	-
	M8340	-	290	0.20	-	170	0.20	-	275	0.20	-	-	-	-	-	-	-	-



SNHQ TRL

	IC	D1	L	W1
	[mm]	[mm]	[mm]	[mm]
1203	12.700	5.00	12.70	3.200
1204	12.700	5.00	12.70	4.500
1205	12.700	5.00	12.70	5.400
1207	12.700	5.00	12.70	7.000

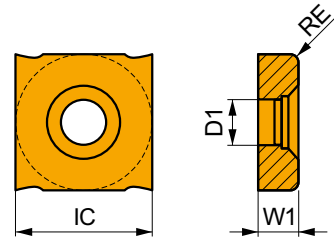

Suitability and starting values for cutting speed (vc), feed (f) and depth of cut (ap). Refer to our Machining Calculator app for further calculations.

Product	RE	P			M			K			N			S			H		
		vc	f	ap	vc	f	ap	vc	f	ap	vc	f	ap	vc	f	ap	vc	f	ap
	[mm]	[m/min]	[mm/tooth]	[mm]	[m/min]	[mm/tooth]	[mm]	[m/min]	[mm/tooth]	[mm]	[m/min]	[mm/tooth]	[mm]	[m/min]	[mm/tooth]	[mm]	[m/min]	[mm/tooth]	[mm]

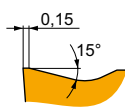
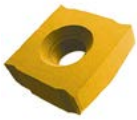

TRL geometry with special design for slot milling.

SNHQ 120305TRL	M8340	0.5	230	0.20	—	135	0.18	—	215	0.20	—	—	—	—	—	—	—	—	—
SNHQ 120310TRL	M8340	1.0	285	0.20	—	170	0.18	—	270	0.20	—	—	—	—	—	—	—	—	—
SNHQ 120315TRL	M8340	1.5	300	0.20	—	180	0.18	—	285	0.20	—	—	—	—	—	—	—	—	—
SNHQ 120405TRL	M8340	0.5	220	0.20	—	130	0.20	—	205	0.20	—	—	—	—	—	—	—	—	—
SNHQ 120410TRL	M8340	1.0	275	0.20	—	165	0.20	—	260	0.20	—	—	—	—	—	—	—	—	—
SNHQ 120415TRL	M8340	1.5	290	0.20	—	170	0.20	—	275	0.20	—	—	—	—	—	—	—	—	—
SNHQ 120505TRL	M8340	0.5	215	0.20	—	125	0.20	—	200	0.20	—	—	—	—	—	—	—	—	—
SNHQ 120510TRL	M8340	1.0	270	0.20	—	160	0.20	—	255	0.20	—	—	—	—	—	—	—	—	—
SNHQ 120515TRL	M8340	1.5	280	0.20	—	165	0.20	—	265	0.20	—	—	—	—	—	—	—	—	—
SNHQ 120705TRL	M8340	0.5	210	0.20	—	125	0.20	—	195	0.20	—	—	—	—	—	—	—	—	—
SNHQ 120710TRL	M8340	1.0	265	0.20	—	155	0.20	—	250	0.20	—	—	—	—	—	—	—	—	—
SNHQ 120715TRL	M8340	1.5	275	0.20	—	165	0.20	—	260	0.20	—	—	—	—	—	—	—	—	—



a_e DC	0.05	0.10	0.15	0.20	0.25	0.30	0.40	0.50	0.60	0.70	0.75	0.80	0.90	1.00
X.V	1.48	1.35	1.27	1.22	1.19	1.16	1.11	1.08	1.05	1.03	1.00	1.00	1.00	1.00

	SNHQ AZEN	SNHQ AZTN	SNHQ 12TRL
RE	-	-	0.5-1.5
BS	-	-	-

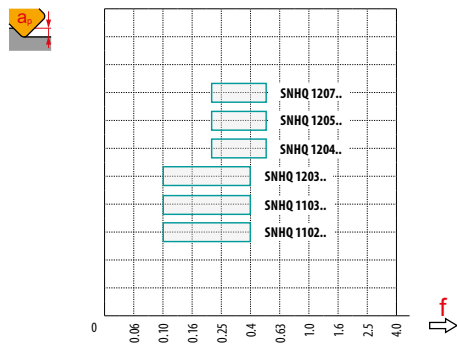



















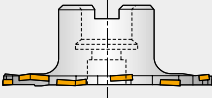

	80	4	16	16
	100	5	24	24
	125	6	31	31
	160	5	43	43
	200	9	62	62
	63	3	10.5	63
	80	4	17.5	80
	100	5	23.5	100
	125	6	24	125
	160	8	41	160



	a_e	5		10		15		20		25	
		f_{min}	f_{max}	f_{min}	f_{max}	f_{min}	f_{max}	f_{min}	f_{max}	f_{min}	f_{max}
	80	0.28	0.36	0.20	0.26	0.17	0.21	-	-	-	-
	100	0.32	0.41	0.23	0.29	0.19	0.24	0.16	0.21	-	-
	125	0.35	0.45	0.25	0.32	0.21	0.27	0.18	0.23	0.16	0.21
	160	0.40	0.51	0.28	0.36	0.23	0.30	0.20	0.26	0.18	0.23
	200	0.44	0.57	0.32	0.41	0.26	0.33	0.23	0.29	0.20	0.26
	63	0.25	0.32	0.18	0.23	0.15	0.19	0.13	0.17	0.12	0.15
	80	0.28	0.36	0.20	0.26	0.17	0.21	0.15	0.19	0.13	0.17
	100	0.32	0.41	0.23	0.29	0.19	0.24	0.16	0.21	0.15	0.19
	125	0.35	0.45	0.25	0.32	0.21	0.27	0.18	0.23	0.16	0.21
	160	0.40	0.51	0.28	0.36	0.23	0.30	0.20	0.26	0.18	0.23

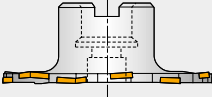

	a _e	32		40		50		63		80	
		f_{\min} 	f_{\max} 	f_{\min} 	f_{\max} 	f_{\min} 	f_{\max} 	f_{\min} 	f_{\max} 	f_{\min} 	f_{\max} 
	80	-	-	-	-	-	-	-	-	-	-
	100	-	-	-	-	-	-	-	-	-	-
	125	-	-	-	-	-	-	-	-	-	-
	160	0.16	0.21	0.15	0.19	-	-	-	-	-	-
	200	0.18	0.23	0.16	0.21	0.15	0.19	-	-	-	-
	63	0.11	0.14	0.10	0.13	0.10	0.12	0.10	0.11	-	-
	80	0.12	0.15	0.11	0.14	0.10	0.13	0.10	0.12	0.10	0.11
	100	0.13	0.17	0.12	0.15	0.11	0.14	0.10	0.13	0.10	0.12
	125	0.15	0.19	0.13	0.17	0.12	0.15	0.11	0.14	0.10	0.13
	160	0.16	0.21	0.15	0.19	0.13	0.17	0.12	0.16	0.11	0.14

	a _e	100		125		160	
		f_{\min} 	f_{\max} 	f_{\min} 	f_{\max} 	f_{\min} 	f_{\max} 
	80	-	-	-	-	-	-
	100	-	-	-	-	-	-
	125	-	-	-	-	-	-
	160	-	-	-	-	-	-
	200	-	-	-	-	-	-
	63	-	-	-	-	-	-
	80	-	-	-	-	-	-
	100	0.10	0.11	-	-	-	-
	125	0.10	0.12	0.10	0.11	-	-
	160	0.10	0.13	0.10	0.12	0.10	0.11



S90CN(XN)

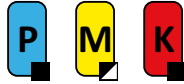

PRAMET

S



Side and Face Disk Milling Cutter with Adjustable Width

90° side and face cutter utilising CNHQ 10 and XNHQ 12, 16 inserts with APMX (slotting depth) of 25 up to 110 mm. Suitable for shoulder, slot, rear side and face milling. Available in arbor or stub arbor style, in range Ø125 up to Ø315 mm. Body treated for longer tool life.

KAPR	90°
CW	14.0 - 30.5 mm

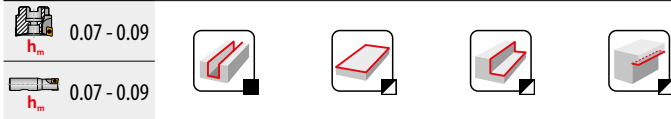
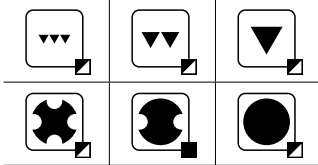
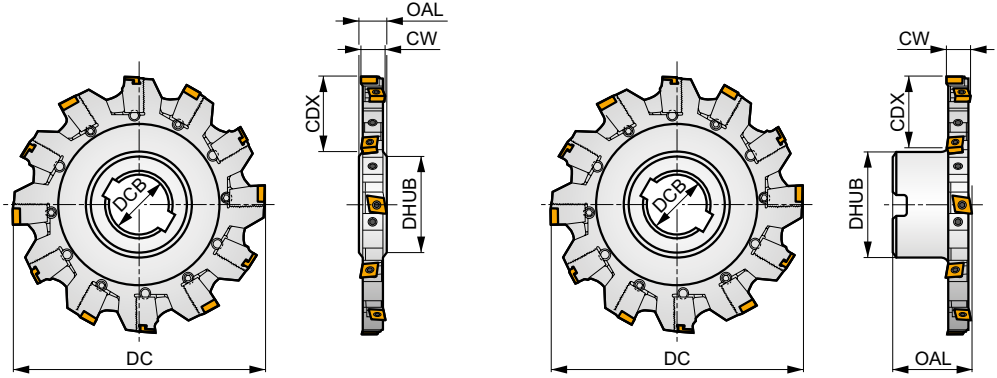
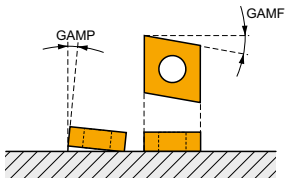

Product	DC	OAL	DCB	DHUB	CDX	CW	GAMF	GAMP	X	Z	max.	kg	G	D	AC		
	[mm]	[mm]	[mm]	[mm]	[mm]	[mm]	[°]	[°]									
125H04N-S90CN10N18	125	18	40	56	34	14.0 ÷ 18.5	-10	4	4	8	-	7800	-	1.50	GI195	DI051	-
160H06N-S90CN10N18	160	18	40	56	50	14.0 ÷ 18.5	-8	4	6	12	-	6900	-	1.80	GI195	DI052	-
160H05N-S90XN12N24	160	24	40	56	50	19.0 ÷ 24.3	-8	5	5	10	-	5200	-	2.50	GI196	DI056	-
200J07N-S90CN10N18	200	18	50	71	60	14.0 ÷ 18.5	-8	4	7	14	-	6100	-	2.85	GI195	DI053	-
200J06N-S90XN12N24	200	24	50	71	60	19.0 ÷ 24.3	-8	5	6	12	-	4700	-	3.60	GI196	DI057	-
200J06N-S90XN16N30	200	30	50	71	60	24.5 ÷ 30.5	-9	5	6	12	-	4000	-	6.00	GI197	DI060	-
250J09N-S90CN10N18	250	18	50	71	85	14.0 ÷ 18.5	-8	4	9	18	-	5500	-	5.30	GI195	DI054	-
250J08N-S90XN12N24	250	24	50	71	85	19.0 ÷ 24.3	-8	5	8	16	-	4200	-	7.50	GI196	DI058	-
250J08N-S90XN16N30	250	30	50	71	85	24.5 ÷ 30.5	-8	5	8	16	-	3600	-	8.00	GI197	DI061	-
315J12N-S90CN10N18	315	18	50	71	110	14.0 ÷ 18.5	-8	4	12	24	-	4900	-	7.80	GI195	DI055	-
315J10N-S90XN12N24	315	24	50	71	110	19.0 ÷ 24.3	-8	5	10	20	-	3700	-	11.00	GI196	DI059	-
315K10N-S90XN16N30	315	30	60	85	110	24.5 ÷ 30.5	-8	5	10	20	-	3200	-	13.00	GI197	DI062	-
125B04R-S90CN10N18	125	50	40	70	25	14.0 ÷ 18.5	-10	4	4	8	-	7800	-	1.65	GI195	DI071	AC003
160B06R-S90CN10N18	160	50	40	70	44	14.0 ÷ 18.5	-8	5	6	12	-	6900	-	2.55	GI195	DI072	-
160B05R-S90XN12N24	160	50	40	70	44	19.0 ÷ 24.3	-8	5	5	10	-	5200	-	2.90	GI196	DI074	-
200C06R-S90XN12N24	200	50	40	90	52	19.0 ÷ 24.3	-8	5	6	12	-	6100	-	4.70	GI196	DI075	-
200C06R-S90XN16N30	200	50	60	130	34	24.5 ÷ 30.5	-9	5	6	12	-	4700	-	5.95	GI197	DI076	-
200C07R-S90CN10N18	200	50	40	90	52	14.0 ÷ 18.5	-8	4	7	14	-	6100	-	4.05	GI195	DI073	-



GI195	CNHQ 1005..
GI196	XNHQ 1205..
GI197	XNHQ 1606..



DI051	125H04N-S-14-08	KL-1418-CN10	KR-1418-CN10	KS 613F	DS 6018F	SDRT20	SS 6005-T09P	SDR T09	US 4011-T15P	3.5	M 4	10.6	SDRT15P	-
DI052	160H06N-S-14-12	KL-1418-CN10	KR-1418-CN10	KS 613F	DS 6018F	SDRT20	SS 6005-T09P	SDR T09	US 4011-T15P	3.5	M 4	10.6	SDRT15P	-
DI053	200J07N-S-14-14	KL-1418-CN10	KR-1418-CN10	KS 613F	DS 6018F	SDRT20	SS 6005-T09P	SDR T09	US 4011-T15P	3.5	M 4	10.6	SDRT15P	-
DI054	250J09N-S-14-18	KL-1418-CN10	KR-1418-CN10	KS 613F	DS 6018F	SDRT20	SS 6005-T09P	SDR T09	US 4011-T15P	3.5	M 4	10.6	SDRT15P	-
DI055	315J12N-S-14-24	KL-1418-CN10	KR-1418-CN10	KS 613F	DS 6018F	SDRT20	SS 6005-T09P	SDR T09	US 4011-T15P	3.5	M 4	10.6	SDRT15P	-
DI056	160H05N-S-19-10	KL-1924-XN12	KR-1924-XN12	KS 617M	DS 6500	-	SS 6005-T09P	SDR T09	US 4011-T15P	3.5	M 4	10.6	SDRT15P	HXX 4
DI057	200J06N-S-19-12	KL-1924-XN12	KR-1924-XN12	KS 617M	DS 6500	-	SS 6005-T09P	SDR T09	US 4011-T15P	3.5	M 4	10.6	SDRT15P	HXX 4
DI058	250J08N-S-19-16	KL-1924-XN12	KR-1924-XN12	KS 617M	DS 6500	-	SS 6005-T09P	SDR T09	US 4011-T15P	3.5	M 4	10.6	SDRT15P	HXX 4
DI059	315J10N-S-19-20	KL-1924-XN12	KR-1924-XN12	KS 617M	DS 6500	-	SS 6005-T09P	SDR T09	US 4011-T15P	3.5	M 4	10.6	SDRT15P	HXX 4
DI060	200J06N-S-25-12	KL-2530-XN16	KR-2530-XN16	KS 623M	DS 6500	-	SS 6005-T09P	SDR T09	US 4011-T15P	3.5	M 4	10.6	SDRT15P	HXX 4
DI061	250J08N-S-25-16	KL-2530-XN16	KR-2530-XN16	KS 623M	DS 6500	-	SS 6005-T09P	SDR T09	US 4011-T15P	3.5	M 4	10.6	SDRT15P	HXX 4
DI062	315K10N-S-25-20	KL-2530-XN16	KR-2530-XN16	KS 623M	DS 6500	-	SS 6005-T09P	SDR T09	US 4011-T15P	3.5	M 4	10.6	SDRT15P	HXX 4
DI071	125B04R-S-14-08	KL-1418-CN10	KR-1418-CN10	KS 613F	DS 6018F	SDRT20	SS 6005-T09P	SDR T09	US 4011-T15P	3.5	M 4	10.6	SDRT15P	-
DI072	160B06R-S-14-12	KL-1418-CN10	KR-1418-CN10	KS 613F	DS 6018F	SDRT20	SS 6005-T09P	SDR T09	US 4011-T15P	3.5	M 4	10.6	SDRT15P	-
DI073	200C07R-S-14-14	KL-1418-CN10	KR-1418-CN10	KS 613F	DS 6018F	SDRT20	SS 6005-T09P	SDR T09	US 4011-T15P	3.5	M 4	10.6	SDRT15P	-
DI074	160B05R-S-19-10	KL-1924-XN12	KR-1924-XN12	KS 617M	DS 6500	-	SS 6005-T09P	SDR T09	US 4011-T15P	3.5	M 4	10.6	SDRT15P	HXX 4
DI075	200C06R-S-19-12	KL-1924-XN12	KR-1924-XN12	KS 617M	DS 6500	-	SS 6005-T09P	SDR T09	US 4011-T15P	3.5	M 4	10.6	SDRT15P	HXX 4
DI076	200C06R-S-25-12	KL-2530-XN16	KR-2530-XN16	KS 623M	DS 6500	-	SS 6005-T09P	SDR T09	US 4011-T15P	3.5	M 4	10.6	SDRT15P	HXX 4



AC003	KS 2040	K.FMH40
-------	---------	---------



CNHQ

PRAMET

	BCH	IC	D1	L	W1
	[mm]	[mm]	[mm]	[mm]	[mm]
1005	0.50	10.000	4.70	10.00	5.400

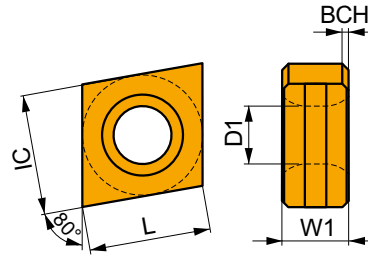

Suitability and starting values for cutting speed (vc), feed (f) and depth of cut (ap). Refer to our Machining Calculator app for further calculations.

Product	RE	P			M			K			N			S			H		
		vc	f	ap	vc	f	ap	vc	f	ap	vc	f	ap	vc	f	ap	vc	f	ap
	[mm]	[m/min]	[mm/tooth]	[mm]	[m/min]	[mm/tooth]	[mm]	[m/min]	[mm/tooth]	[mm]	[m/min]	[mm/tooth]	[mm]	[m/min]	[mm/tooth]	[mm]	[m/min]	[mm/tooth]	[mm]

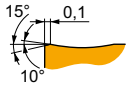
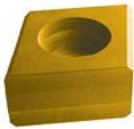

Special design for slot milling with light to heavy cutting conditions.

CNHQ 1005AZTN	M8330	-	310	0.15	-	185	0.14	-	290	0.15	-	-	-	-	-	-	-	-	-
	M8340	-	280	0.15	-	165	0.14	-	265	0.15	-	-	-	-	-	-	-	-	-

XNHQ

PRAMET

	BCH	IC	D1	L	W1
	[mm]	[mm]	[mm]	[mm]	[mm]
1205	0.50	10.000	4.70	12.70	5.400
1606	0.50	12.000	5.90	16.00	6.400

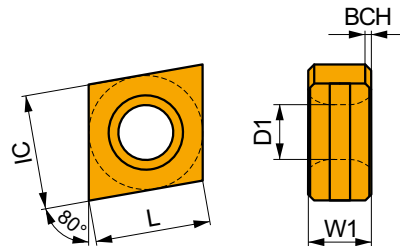

Suitability and starting values for cutting speed (vc), feed (f) and depth of cut (ap). Refer to our Machining Calculator app for further calculations.

Product	RE	P			M			K			N			S			H		
		vc	f	ap	vc	f	ap	vc	f	ap	vc	f	ap	vc	f	ap	vc	f	ap
	[mm]	[m/min]	[mm/tooth]	[mm]	[m/min]	[mm/tooth]	[mm]	[m/min]	[mm/tooth]	[mm]	[m/min]	[mm/tooth]	[mm]	[m/min]	[mm/tooth]	[mm]	[m/min]	[mm/tooth]	[mm]

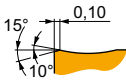

Special design for slot milling.

XNHQ 1205AZTN	M8330	-	310	0.15	-	185	0.14	-	290	0.15	-	-	-	-	-	-	-	-	-
	M8340	-	275	0.15	-	165	0.14	-	260	0.15	-	-	-	-	-	-	-	-	-
XNHQ 1606AZTN	M8330	-	300	0.15	-	180	0.14	-	285	0.15	-	-	-	-	-	-	-	-	-
	M8340	-	270	0.15	-	160	0.14	-	255	0.15	-	-	-	-	-	-	-	-	-



a_e DC	0.05	0.10	0.15	0.20	0.25	0.30	0.40	0.50	0.60	0.70	0.75	0.80	0.90	1.00
$X.V$	1.48	1.35	1.27	1.22	1.19	1.16	1.11	1.08	1.05	1.03	1.00	1.00	1.00	1.00

	CNHQ 10	XNHQ 12	XNHQ 16
	-	-	-

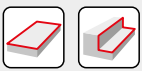
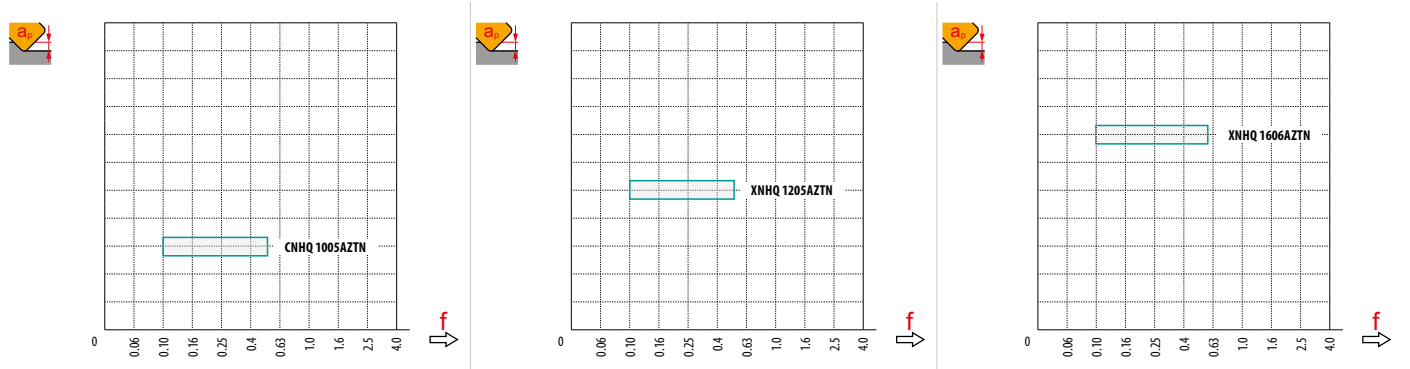























	125	4	34	34
	160	6	50	50
	200	7	60	60
	250	9	85	85
	315	12	110	110
	125	4	25	125
	160	6	44	160
	200	7	52	200



	a_e	5		10		15		20		25	
		f_{min}	f_{max}	f_{min}	f_{max}	f_{min}	f_{max}	f_{min}	f_{max}	f_{min}	f_{max}
	125	0.35	0.45	0.25	0.32	0.21	0.27	0.18	0.23	0.16	0.21
	160	0.40	0.51	0.28	0.36	0.23	0.30	0.20	0.26	0.18	0.23
	200	0.44	0.57	0.32	0.41	0.26	0.33	0.23	0.29	0.20	0.26
	250	0.50	0.64	0.35	0.45	0.29	0.37	0.25	0.32	0.23	0.29
	315	0.56	0.72	0.39	0.51	0.32	0.42	0.28	0.36	0.25	0.32
	125	0.35	0.45	0.25	0.32	0.21	0.27	0.18	0.23	0.16	0.21
	160	0.40	0.51	0.28	0.36	0.23	0.30	0.20	0.26	0.18	0.23
	200	0.44	0.57	0.32	0.41	0.26	0.33	0.23	0.29	0.20	0.26

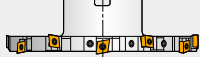

	a_e	32		40		50		63		80	
		f_{min} 	f_{max} 	f_{min} 	f_{max} 	f_{min} 	f_{max} 	f_{min} 	f_{max} 	f_{min} 	f_{max} 
	125	0.15	0.19	–	–	–	–	–	–	–	–
	160	0.16	0.21	0.15	0.19	–	–	–	–	–	–
	200	0.18	0.23	0.16	0.21	0.15	0.19	–	–	–	–
	250	0.20	0.26	0.18	0.23	0.16	0.21	0.15	0.19	0.13	0.17
	315	0.22	0.29	0.20	0.26	0.18	0.23	0.16	0.21	0.15	0.19
	125	0.15	0.19	0.13	0.17	0.12	0.15	0.11	0.14	0.10	0.13
	160	0.16	0.21	0.15	0.19	0.13	0.17	0.12	0.16	0.11	0.14
	200	0.18	0.23	0.16	0.21	0.15	0.19	0.13	0.17	0.12	0.15

	a_e	100		125		160		200	
		f_{min} 	f_{max} 	f_{min} 	f_{max} 	f_{min} 	f_{max} 	f_{min} 	f_{max} 
	125	–	–	–	–	–	–	–	–
	160	–	–	–	–	–	–	–	–
	200	–	–	–	–	–	–	–	–
	250	–	–	–	–	–	–	–	–
	315	0.13	0.17	–	–	–	–	–	–
	125	0.10	0.12	0.10	0.11	–	–	–	–
	160	0.10	0.13	0.10	0.12	0.10	0.11	–	–
	200	0.11	0.14	0.10	0.13	0.10	0.12	0.10	0.11























INDEXABLE COPY MILLS



INDEXABLE COPY MILLS – NAVIGATOR

COPY MILLING



	SRC10	SRC12	SRC16	SRC20	SRD05
	–	–	–	–	–
	APMX [mm] 5.0	APMX [mm] 6.0	APMX [mm] 8.0	APMX [mm] 10.0	APMX [mm] 1.5
	DCX [mm] 25 – 66	DCX [mm] 40 – 100	DCX [mm] 63 – 160	DCX [mm] 80 – 160	DCX [mm] 10 – 15
Cylindrical shank					
	DCX = 25 – 32 [mm]				
Weldon					
Modular					
	DCX = 25 – 42 [mm]				
Shell mill					
	DCX = 40 – 66 [mm]				
Page	526	530	534	538	542
ISO	P M K S H	P M K S H	P M K S H	P M K S H	P K H
Insert shape					
Inserts	RC 10T3	RC 1204	RC 1606	RC 2006	RD 0501
No. of cutting edges	–	–	–	–	–
Shape surfaces milling (copy milling) 	■	■	■	■	■
Face milling 	■	■	■	■	■
Helical interpolation 	■	■	■	■	■
Progressive plunging 	■	■	■	■	■
Ramping 	■	■	■	■	■
Shallow shoulder milling 					
Deep shoulder milling 					
Chamfer milling 					
Plunge milling 					



INDEXABLE COPY MILLS – NAVIGATOR



COPY MILLING



























	SRD07		SRD10		SRD12		SRD16		L2-SZP		K3-CXP	
	-		-		-		-		-		-	
	APMX [mm]	2.0	APMX [mm]	2.5	APMX [mm]	3.0	APMX [mm]	4.0	APMX [mm]	8.9 – 44.7	APMX [mm]	8,0 – 16.0
	DCX [mm]	15 – 25	DCX [mm]	20 – 52	DCX [mm]	24 – 80	DCX [mm]	32 – 100	DCX [mm]	10 – 50	DCX [mm]	16 – 32
		DCX = 15 [mm]		DCX = 20 [mm]						DCX = 10 – 32 [mm]		DCX = 16 – 32 [mm]
		DCX = 15 – 25 [mm]		DCX = 20 – 42 [mm]		DCX = 24 – 42 [mm]		DCX = 32 [mm]		DCX = 10 – 32 [mm]		DCX = 16 – 25 [mm]
				DCX = 42 – 52 [mm]		DCX = 50 – 80 [mm]		DCX = 52 – 100 [mm]				
	📖 545		📖 550		📖 556		📖 562		📖 568		📖 575	
	P	M	K	N	S	H	P	M	K	N	S	H
		RD 0702		RD 1003		RD 12T3		RD 1604		ZP		XP
		-		-		-		-		2		1
	■		■		■		■		■		■	
	■		■		■		■					
	■		■		■		■					
	■		■		■		■					
	■		■		■		■					



INDEXABLE COPY MILLS – NAVIGATOR

<<< COPY MILLING >>>













	K2-SRC		K2-SLC		K2-PPH		SVC22C		SWN04C	
	-		90°		-		90°		90° (93°)	
	APMX [mm]	0.6 – 3.2	APMX [mm]	1.0 – 3.0	APMX [mm]	0.3 – 4.0	APMX [mm]	3.0 (16.0)	APMX [mm]	0.5 (2.0)
	DCX [mm]	8 – 20	DCX [mm]	12 – 20	DCX [mm]	8 – 32	DC [mm]	32 – 80	DC [mm]	20 – 35
Cylindrical shank		DCX = 8 – 20 [mm]				DCX = 8 – 32 [mm]		DC = 32 – 40 [mm]		DC = 20 – 32 [mm]
Weldon										
Modular		DCX = 8 – 20 [mm]				DCX = 16 – 20 [mm]		DC = 32 – 40 [mm]		DC = 20 – 35 [mm]
Shell mill								DC = 50 – 80 [mm]		
Page	579		588		592		604		607	
ISO	P	M	K	H	P	M	K	H	S	H
Insert shape										
Inserts	RC LC		LC		PPH PPHF PPHT		VCGT 220530		WN.. 0403	
No. of cutting edges	2		2		2		2		6	
Shape surfaces milling (copy milling) 	■		■		■				■	
Face milling 									■	
Helical interpolation 			☑		☑		■			
Progressive plunging 			☑		☑		■			
Ramping 			☑		☑		☑		■	
Shallow shoulder milling 							☑			
Deep shoulder milling 							☑		■	
Chamfer milling 			☑		☑					
Plunge milling 									■	



INDEXABLE COPY MILLS – NAVIGATOR



COPY MILLING

SCN05C					
90° (93°)					
APMX [mm]	0.5 (1.0)				
DC [mm]	12 – 20				
	DC = 12 – 20 [mm]				
	DC = 12 – 20 [mm]				
610					
P	K	H			
					
CN.. 0502					
4					
	■				
	■				
					
					
	■				
					
	■				
					
	■				



SRC10



PRAMET

S



Copy Milling Cutter for Round Inserts RCMT 10 with Internal Coolant

Milling cutter for copy milling utilising positive RCMT 10 inserts with APMX of 5.0 mm. Internal coolant. Suitable for face, helical interpolation, ramping, progressive plunge and high-feed milling. Available in cylindrical, modular and arbor style, in range Ø25 up to Ø66 mm. Body treated for longer tool life.

APMX	5.0 mm
------	--------

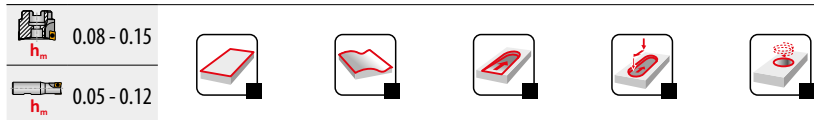
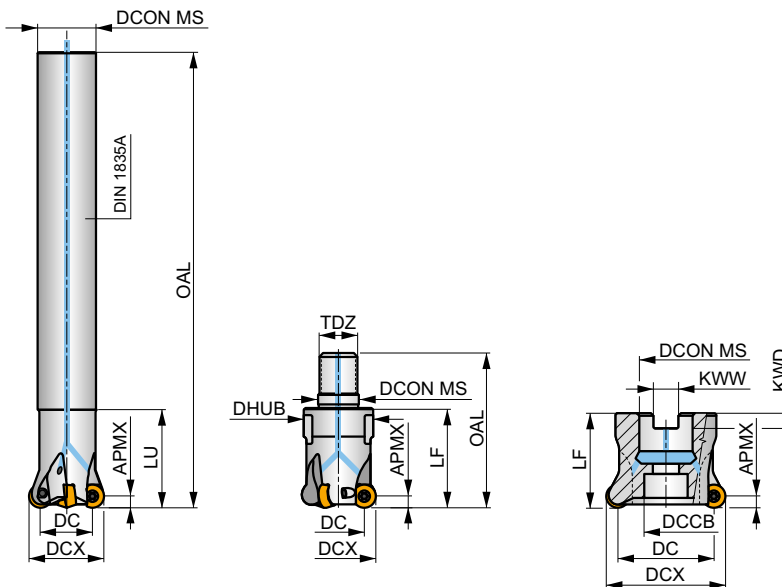
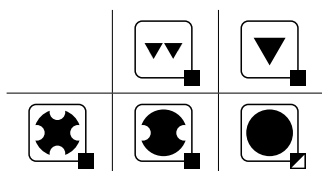
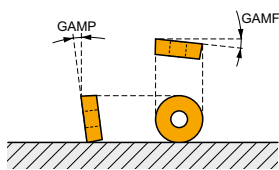

Product	DCX	DC	OAL	DCON MS	DHUB	DCCB	LU	LF	TDZ	KWW	KWD	GAMF	GAMP	max.		kg	G1328		
	[mm]	[mm]	[mm]	[mm]	[mm]	[mm]	[mm]	[mm]	[mm]	[mm]	[mm]	[°]	[°]						
25E2R034A20-SRC10-C	25	15	170	20	-	-	34	-	-	-	-	-3	-7	2	-	20900	✓	0.36	G1328 C0010
25E3R034A20-SRC10-C	25	15	170	20	-	-	34	-	-	-	-	-3	-7	3	-	20900	✓	0.36	G1328 C0010
32E3R042A25-SRC10-C	32	22	200	25	-	-	42	-	-	-	-	-2.6	-7	4	-	18500	✓	0.67	G1328 C0010
32E4R042A25-SRC10-C	32	22	200	25	-	-	42	-	-	-	-	-2.6	-7	3	-	18500	✓	0.66	G1328 C0010
	25E2R032M12-SRC10-C	25	15	54	12.5	21	-	32	M12	-	-	-3	-7	2	-	20900	✓	0.11	G1328 C0010
	25E3R032M12-SRC10-C	25	15	54	12.5	21	-	32	M12	-	-	-3	-7	3	-	20900	✓	0.08	G1328 C0010
	32E3R042M16-SRC10-C	32	22	65	17	29	-	42	M16	-	-	-2.6	-7	3	-	18500	✓	0.22	G1328 C0010
	32E4R042M16-SRC10-C	32	22	65	17	29	-	42	M16	-	-	-2.6	-7	4	-	18500	✓	0.21	G1328 C0010
	35E4R042M16-SRC10-C	35	25	65	17	29	-	42	M16	-	-	-2.4	-7	4	-	17700	✓	0.20	G1328 C0010
42E4R042M16-SRC10-C	42	32	65	17	29	-	42	M16	-	-	-2.1	-7	4	-	16100	✓	0.22	G1328 C0010	
42E5R042M16-SRC10-C	42	32	65	17	29	-	42	M16	-	-	-2.1	-7	5	-	16100	✓	0.21	G1328 C0010	
	40A05R-SMORC10-C	40	30	-	16	-	14	40	-	8.4	5.6	-2.2	-7	5	-	16500	✓	0.16	G1328 C0012
	50A05R-SMORC10-C	50	40	-	22	-	18	40	-	10.4	6.3	-2	-7	5	-	14800	✓	0.28	G1328 C0013
	50A06R-SMORC10-C	50	40	-	22	-	18	40	-	10.4	6.3	-2	-7	6	-	14800	✓	0.24	G1328 C0013
	52A05R-SMORC10-C	52	42	-	22	-	18	40	-	10.4	6.3	-2	-7	5	-	14500	✓	0.29	G1328 C0013
	52A06R-SMORC10-C	52	42	-	22	-	18	40	-	10.4	6.3	-2	-7	6	-	14500	✓	0.28	G1328 C0013
	63A06R-SMORC10-C	63	53	-	22	-	18	40	-	10.4	6.3	-1.8	-7	6	-	13200	✓	0.46	G1328 C0013
	63A07R-SMORC10-C	63	53	-	22	-	18	40	-	10.4	6.3	-1.8	-7	7	-	13200	✓	0.46	G1328 C0013
	66A06R-SMORC10-C	66	56	-	27	-	22	50	-	12.4	7	-1.4	-7	6	-	12800	✓	0.58	G1328 C0014
	66A07R-SMORC10-C	66	56	-	27	-	22	50	-	12.4	7	-1.4	-7	7	-	12800	✓	0.57	G1328 C0014





CO010	US 63509-T10P	3.0	M 3.5	9	Flag T10P	-
CO012	US 63509-T10P	3.0	M 3.5	9	Flag T10P	HS 0830C
CO013	US 63509-T10P	3.0	M 3.5	9	Flag T10P	HS 1030C
CO014	US 63509-T10P	3.0	M 3.5	9	Flag T10P	HS 1230C

RCMT 10



	INSD	D1	S
	[mm]	[mm]	[mm]
10T3	10.0	3.90	3.97

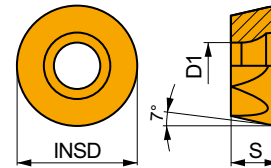

Suitability and starting values for cutting speed (vc), feed (f) and depth of cut (ap). Refer to our Machining Calculator app for further calculations.

Product	RE [mm]	P			M			K			N			S			H		
		vc [m/min]	f [mm/tooth]	ap [mm]	vc [m/min]	f [mm/tooth]	ap [mm]	vc [m/min]	f [mm/tooth]	ap [mm]	vc [m/min]	f [mm/tooth]	ap [mm]	vc [m/min]	f [mm/tooth]	ap [mm]	vc [m/min]	f [mm/tooth]	ap [mm]

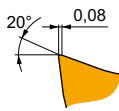

F geometry with highly positive design for light machining.

RCMT 10T3MOSN-F	M6330	-	■	340	0.10	1.0	■	240	0.09	1.0	-	-	-	■	100	0.08	0.8	-	-	-
	M8310	-	■	445	0.10	1.0	■	225	0.09	1.0	-	-	-	-	-	-	-	-	-	-
	M8330	-	■	395	0.10	1.0	■	235	0.09	1.0	-	-	-	■	95	0.08	0.8	-	-	-

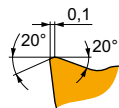

M geometry with highly positive design for medium machining.

RCMT 10T3MOSN-M	M6330	-	■	310	0.12	1.0	■	220	0.11	1.0	-	-	-	■	90	0.11	0.8	-	-	-
	M8310	-	■	400	0.12	1.0	■	200	0.11	1.0	■	380	0.12	1.0	-	-	-	-	-	-
	M8330	-	■	360	0.12	1.0	■	215	0.11	1.0	■	340	0.12	1.0	■	90	0.11	0.8	-	-
	M8340	-	■	330	0.12	1.0	■	195	0.11	1.0	■	310	0.12	1.0	■	80	0.11	0.8	-	-
	M8345	-	■	260	0.12	1.0	■	155	0.11	1.0	-	-	-	■	65	0.11	0.8	-	-	
	M9325	-	■	465	0.12	1.0	-	-	-	-	■	440	0.12	1.0	-	-	-	-	-	-
	M9340	-	■	425	0.12	1.0	■	255	0.11	1.0	-	-	-	■	105	0.11	0.8	-	-	

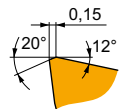

R geometry with positive design for rough copy machining.

RCMT 10T3MOSN-R	M5315	-	■	435	0.17	1.0	-	-	-	-	■	410	0.17	1.0	-	-	-	■	85	0.15	1.0	
	M8310	-	■	345	0.17	1.0	-	-	-	-	■	325	0.17	1.0	-	-	-	■	65	0.15	1.0	
	M8330	-	■	310	0.17	1.0	-	-	-	-	■	290	0.17	1.0	■	75	0.17	0.8	■	60	0.15	1.0
	M8340	-	■	285	0.17	1.0	-	-	-	-	■	270	0.17	1.0	■	70	0.17	0.8	-	-		
	M9325	-	■	395	0.17	1.0	-	-	-	-	■	375	0.17	1.0	-	-	-	■	75	0.15	1.0	



a_e / DCX	5 %	10 %	15 %	20 %	25 %	30 %	40 %	50 %	60 %	70 %	75 %	80 %	90 %	100 %
	1.48	1.35	1.27	1.22	1.19	1.16	1.11	1.08	1.05	1.03	1.00	1.00	1.00	1.00
	2.20	1.60	1.35	1.20	1.10	0.95	0.85	0.75	0.85	0.95	1.00	1.00	1.00	1.00
	0.64	0.64	0.64	0.64	0.64	0.65	0.65	0.67	0.68	0.71	0.72	0.74	0.79	1.00

	RCMT 10-F	RCMT 10-M	RCMT 10-R
	5.0	5.0	5.0
	-	-	-

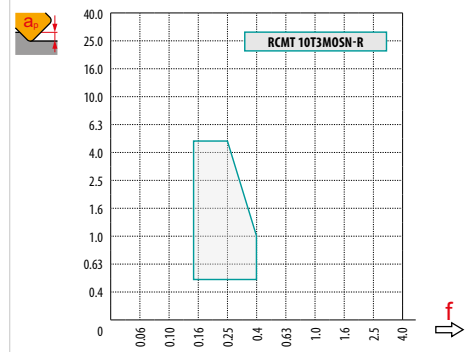
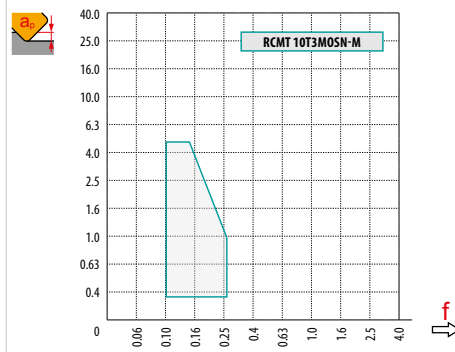
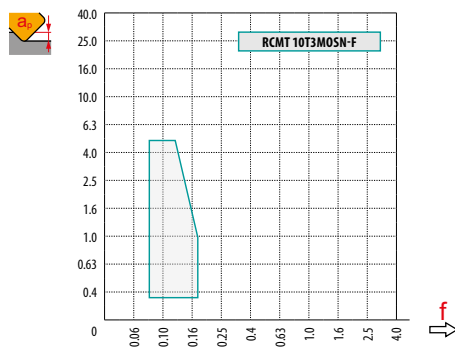

		0.00	0.15	0.30	0.50	0.75	1.00	1.25	1.50	2.00	2.50	3.00	4.00	5.00
25		15.00	17.43	18.41	19.36	20.27	21.00	21.61	22.14	23.00	23.66	24.17	24.80	25.00
32		22.00	24.43	25.41	26.36	27.27	28.00	28.61	29.14	30.00	30.66	31.17	31.80	32.00
35		25.00	27.43	28.41	29.36	30.27	31.00	31.61	32.14	33.00	33.66	34.17	34.80	35.00
40		30.00	32.43	33.41	34.36	35.27	36.00	36.61	37.14	38.00	38.66	39.17	39.80	40.00
42		32.00	34.43	35.41	36.36	37.27	38.00	38.61	39.14	40.00	40.66	41.17	41.80	42.00
50		40.00	42.43	43.41	44.36	45.27	46.00	46.61	47.14	48.00	48.66	49.17	49.80	50.00
52		42.00	44.43	45.41	46.36	47.27	48.00	48.61	49.14	50.00	50.66	51.17	51.80	52.00
63		53.00	55.43	56.41	57.36	58.27	59.00	59.61	60.14	61.00	61.66	62.17	62.80	63.00
66	56.00	58.43	59.41	60.36	61.27	62.00	62.61	63.14	64.00	64.66	65.17	65.80	66.00	
		-	0.15	0.30	0.50	0.75	1.00	1.25	1.50	2.00	2.50	3.00	4.00	5.00
		-	0.90	0.64	0.50	0.41	0.35	0.32	0.29	0.25	0.23	0.21	0.19	0.17

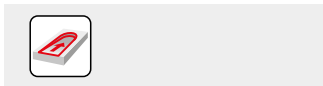

DCX	RPMX	APMX/I
25	13.2	5/23
32	12.6	5/24
35	12.3	5/24
40	9.5	5/31
42	6.5	5/45
50	6.4	5/46
52	6.1	5/48
63	4.7	5/62
66	4.4	5/66

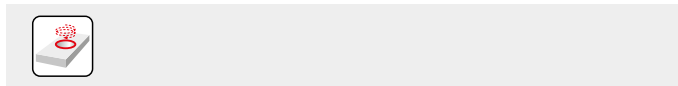

DCX	DMIN	DMAX	SMAX DMIN	SMAX DMAX
25	32.0	50.0	3.0	3.0
32	45.0	64.0	3.0	3.0
35	51.0	70.0	3.0	3.0
40	61.0	80.0	3.0	3.0
42	65.0	84.0	3.0	3.0
50	81.0	100.0	3.0	3.0
52	85.0	104.0	3.0	3.0
63	107.0	126.0	3.0	3.0
66	113.0	132.0	3.0	3.0

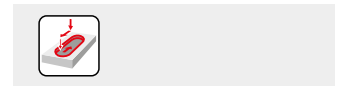

2.24

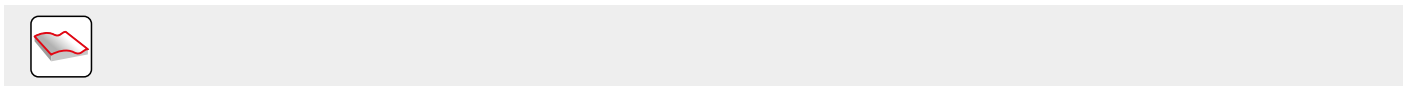

DCX	μm	3	5	10	15	20	30	40	50	60	80	100
25		0.548	0.707	1.000	1.225	1.414	1.732	2.000	2.236	2.449	2.828	3.162
32		0.620	0.800	1.131	1.386	1.600	1.960	2.263	2.530	2.771	3.200	3.578
35		0.648	0.837	1.183	1.449	1.673	2.049	2.366	2.646	2.898	3.347	3.742
40		0.693	0.894	1.265	1.549	1.789	2.191	2.530	2.828	3.098	3.578	4.000
42		0.710	0.917	1.296	1.587	1.833	2.245	2.592	2.898	3.175	3.666	4.099
50		0.775	1.000	1.414	1.732	2.000	2.449	2.828	3.162	3.464	4.000	4.472
52		0.790	1.020	1.442	1.766	2.040	2.498	2.884	3.225	3.533	4.079	4.561
63		0.869	1.122	1.587	1.944	2.245	2.750	3.175	3.550	3.888	4.490	5.020
66		0.890	1.149	1.625	1.990	2.298	2.814	3.250	3.633	3.980	4.596	5.138
RE	μm	3	5	10	15	20	30	40	50	60	80	100
5.0		0.346	0.447	0.632	0.775	0.894	1.095	1.265	1.414	1.549	1.789	2.000

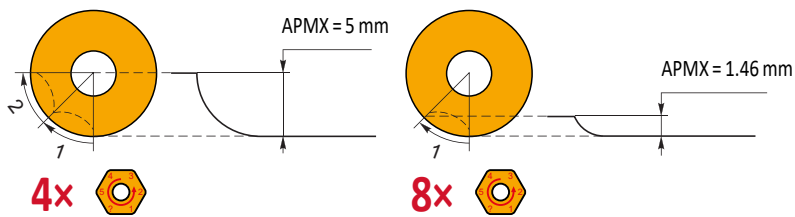
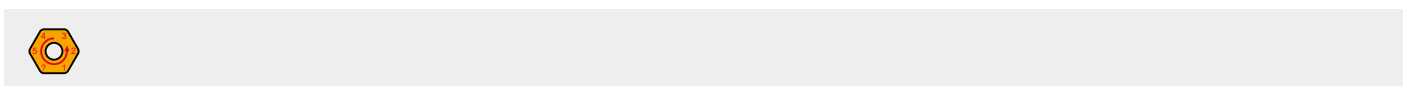



SRC12

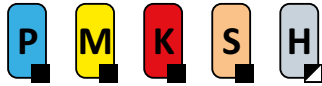

PRAMET

S



Copy Milling Cutter for Round Inserts RCMT 12 with Internal Coolant

Milling cutter for medium copy milling utilising positive RCMT 12 inserts with APMX of 6 mm. Internal coolant. Suitable for face, helical interpolation, ramping, progressive plunge and high-feed milling. Available in arbor style only in range Ø40 up to Ø100 mm. Body treated for longer tool life.

APMX	6.0 mm
------	--------

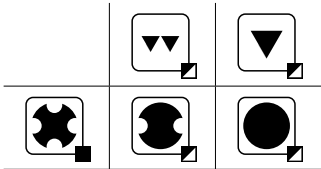
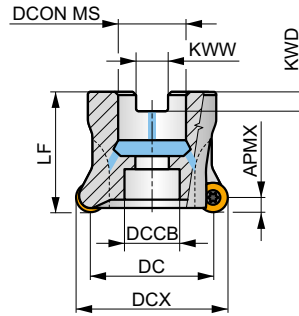
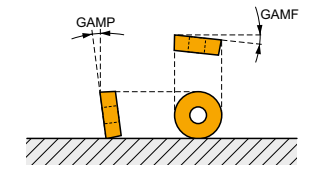

Product	DCX	DC	DCON MS	DCCB	LF	KWW	KWD	GAMF	GAMP	��	��	max.	kg	��	��	��	
	[mm]	[mm]	[mm]	[mm]	[mm]	[mm]	[mm]	[°]	[°]								
40A03R-SMORC12-C	40	28	16	12	40	8.4	5.6	-2.1	-7	3	-	14800	✓	0.29	GI279	C0022	
50A04R-SMORC12-C	50	38	22	18	40	10.4	6.3	-2	-7	4	-	13200	✓	0.39	GI279	C0023	
52A05R-SMORC12-C	52	40	22	18	40	10.4	6.3	-2	-7	5	-	12900	✓	0.36	GI279	C0023	
63A05R-SMORC12-C	63	51	22	30	40	10.4	6.3	-2	-7	5	-	11800	✓	0.51	GI279	C0023	
66A06R-SMORC12-C	66	54	27	22	50	12.4	7	-1.5	-7	6	-	11400	✓	0.67	GI279	C0024	
80A05R-SMORC12-C	80	68	27	37	50	12.4	7	-1.7	-7	5	-	10400	✓	1.10	GI279	C0024	
100A06R-SMORC12-C	100	88	32	45	50	14.4	8	-1.8	-7	6	-	9300	✓	1.83	GI279	C0021	AC002

GI279	RCMT 1204M0..
-------	---------------

Icon	Part Number	Nm	Thread	Length	Material	Material	
Icon 1	US 63509-T15P	3.0	M 3.5	10	D-T08P/T15P	FG-15	
Icon 2	US 63509-T15P	3.0	M 3.5	10	D-T08P/T15P	FG-15	HS 90835
Icon 3	US 63509-T15P	3.0	M 3.5	10	D-T08P/T15P	FG-15	HS 1030C
Icon 4	US 63509-T15P	3.0	M 3.5	10	D-T08P/T15P	FG-15	HS 1230C

AC002	KS 1635	K.FMH32
-------	---------	---------



RCMT 12

	INSD	D1	S
	[mm]	[mm]	[mm]
1204	12.0	4.40	4.76

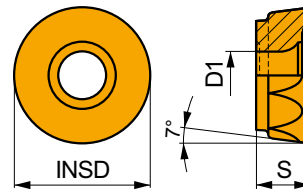

Suitability and starting values for cutting speed (vc), feed (f) and depth of cut (ap). Refer to our Machining Calculator app for further calculations.

Product	RE	P			M			K			N			S			H		
		vc	f	ap	vc	f	ap	vc	f	ap	vc	f	ap	vc	f	ap	vc	f	ap
	[mm]	[m/min]	[mm/tooth]	[mm]	[m/min]	[mm/tooth]	[mm]	[m/min]	[mm/tooth]	[mm]	[m/min]	[mm/tooth]	[mm]	[m/min]	[mm/tooth]	[mm]	[m/min]	[mm/tooth]	[mm]

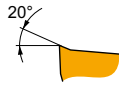

F geometry with highly positive design for light machining.

RCMT 1204MOEN-F	8215	-	390	0.10	1.5	230	0.09	1.5	-	-	-	95	0.07	1.2	-	-	-
	M8310	-	420	0.10	1.5	210	0.09	1.5	-	-	-	-	-	-	-	-	-
	M8330	-	380	0.10	1.5	225	0.09	1.5	-	-	-	95	0.07	1.2	-	-	-

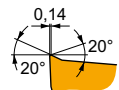

M geometry with highly positive design for medium machining.

RCMT 1204MOSN-M	M6330	-	265	0.20	1.5	185	0.18	1.5	-	-	-	75	0.16	1.2	-	-	-
	M8310	-	335	0.20	1.5	170	0.18	1.5	315	0.20	1.5	-	-	-	-	-	-
	M8330	-	305	0.20	1.5	180	0.18	1.5	285	0.20	1.5	75	0.16	1.2	-	-	-
	M8345	-	325	0.20	1.5	135	0.18	1.5	-	-	-	55	0.16	1.2	-	-	-
	M9325	-	380	0.20	1.5	-	-	-	360	0.20	1.5	-	-	-	-	-	-
	M9340	-	345	0.20	1.5	205	0.18	1.5	-	-	-	85	0.16	1.2	-	-	-

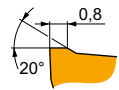

EN-R geometry with positive design for rough copy machining.

RCMT 1204MOEN-R	M8310	-	280	0.30	1.5	140	0.27	1.5	265	0.30	1.5	-	-	-	55	0.15	1.0
	M8330	-	260	0.30	1.5	155	0.27	1.5	245	0.30	1.5	65	0.24	1.2	50	0.15	1.0

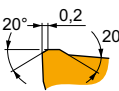

SN-R geometry with positive design for rough copy machining.

RCMT 1204MOSN-R	M8345	-	190	0.35	1.5	-	-	-	-	-	-	45	0.25	1.2	-	-	-
	M9315	-	315	0.35	1.5	-	-	-	295	0.35	1.5	-	-	-	60	0.15	1.0



a_e DCX	5 %	10 %	15 %	20 %	25 %	30 %	40 %	50 %	60 %	70 %	75 %	80 %	90 %	100 %
	1.48	1.35	1.27	1.22	1.19	1.16	1.11	1.08	1.05	1.03	1.00	1.00	1.00	1.00
	2.20	1.60	1.35	1.20	1.10	0.95	0.85	0.75	0.85	0.95	1.00	1.00	1.00	1.00
	0.64	0.64	0.64	0.64	0.64	0.65	0.65	0.67	0.68	0.71	0.72	0.74	0.79	1.00

	RCMT 12-F	RCMT 12-M	RCMT 12 EN-R	RCMT 12 SN-R
	6.0	6.0	6.0	6.0
	-	-	-	-

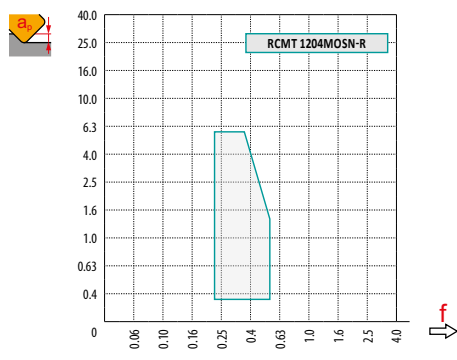
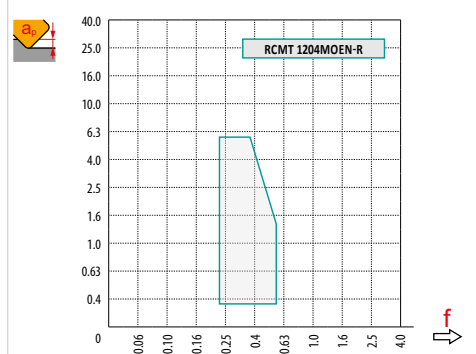
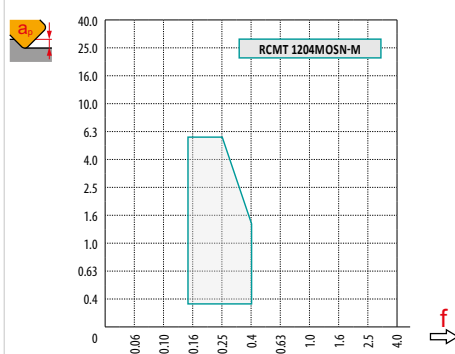
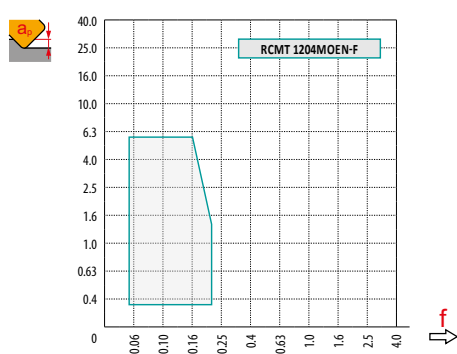

		0.00	0.30	0.50	0.75	1.00	1.25	1.50	2.00	2.50	3.00	4.00	5.00	6.00
40		28.0	31.7	32.8	33.8	34.6	35.3	35.9	36.9	37.7	38.4	39.3	39.8	40.0
50		38.0	41.7	42.8	43.8	44.6	45.3	45.9	46.9	47.7	48.4	49.3	49.8	50.0
52		40.0	43.7	44.8	45.8	46.6	47.3	47.9	48.9	49.7	50.4	51.3	51.8	52.0
63		51.0	54.7	55.8	56.8	57.6	58.3	58.9	59.9	60.7	61.4	62.3	62.8	63.0
66		54.0	57.7	58.8	59.8	60.6	61.3	61.9	62.9	63.7	64.4	65.3	65.8	66.0
80		68.0	71.7	72.8	73.8	74.6	75.3	75.9	76.9	77.7	78.4	79.3	79.8	80.0
100	88.0	91.7	92.8	93.8	94.6	95.3	95.9	96.9	97.7	98.4	99.3	99.8	100.0	
		-	0.30	0.50	0.75	1.00	1.25	1.50	2.00	2.50	3.00	4.00	5.00	6.00
		-	0.95	0.74	0.61	0.53	0.47	0.43	0.38	0.34	0.31	0.28	0.25	0.24

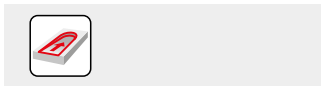

DC	RPMX	APMX/I
40	9.0	6.0/39
50	7.0	6.0/50
52	6.5	6.0/53
63	5.0	6.0/70
66	4.5	6.0/76
80	3.0	5.1/100
100	2.0	3.3/100

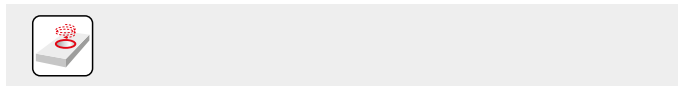

DC	DMIN	DMAX	SMAX DMIN	SMAX DMAX
40	56.0	80.0	6.0	6.0
50	76.0	100.0	6.0	6.0
52	80.0	104.0	6.0	6.0
63	102.0	126.0	6.0	6.0
66	108.0	132.0	6.0	6.0
80	136.0	160.0	6.0	6.0
100	176.0	200.0	6.0	6.0

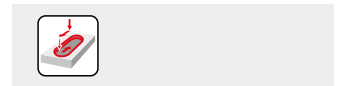

3.5



DC	μm	3	5	10	15	20	30	40	50	60	80	100
40		0.693	0.894	1.265	1.549	1.789	2.191	2.530	2.828	3.098	3.578	4.000
50		0.775	1.000	1.414	1.732	2.000	2.449	2.828	3.162	3.464	4.000	4.472
52		0.790	1.020	1.442	1.766	2.040	2.498	2.884	3.225	3.533	4.079	4.561
63		0.869	1.122	1.587	1.944	2.245	2.750	3.175	3.550	3.888	4.490	5.020
66		0.890	1.149	1.625	1.990	2.298	2.814	3.250	3.633	3.980	4.596	5.138
80		0.980	1.265	1.789	2.191	2.530	3.098	3.578	4.000	4.382	5.060	5.657
100		1.095	1.414	2.000	2.449	2.828	3.464	4.000	4.472	4.899	5.657	6.325
RE	μm	3	5	10	15	20	30	40	50	60	80	100
6.0		0.379	0.490	0.693	0.849	0.980	1.200	1.386	1.549	1.697	1.960	2.191

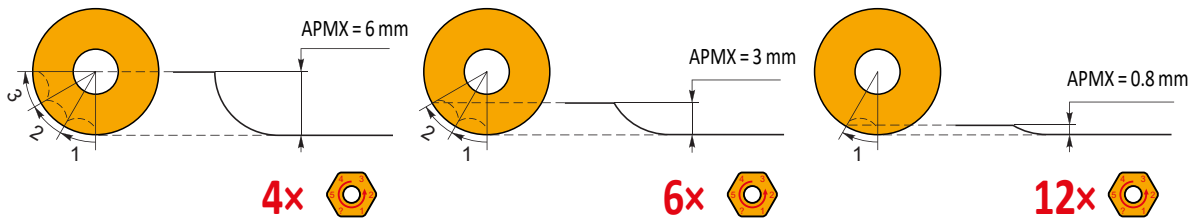



SRC16

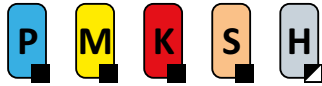

PRAMET

S



Copy Milling Cutter for Round Inserts RCMT 16 with Internal Coolant

Milling cutter for medium to heavy copy milling utilising positive RCMT 16 inserts with APMX of 8 mm. Internal coolant. Suitable for face, helical interpolation, ramping, progressive plunge and high-feed milling. Available in arbor style in range Ø63 up to Ø160 mm. Body treated for longer tool life.

APMX	8.0 mm
------	--------

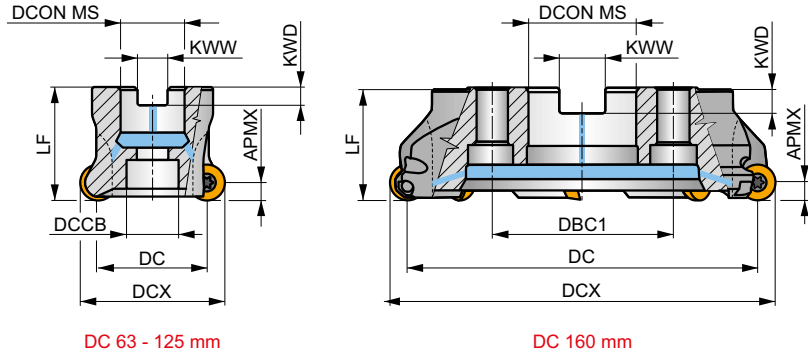
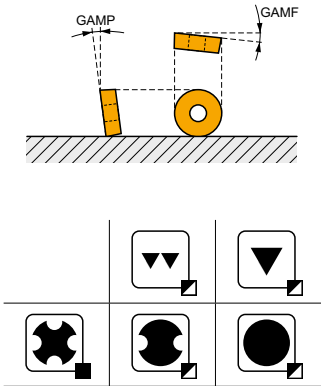

Product	DCX	DC	DCON MS	DCCB	DBC1	LF	KWW	KWD	GAMF	GAMP	Icons	kg	Material	Coating	Other			
	[mm]	[mm]	[mm]	[mm]	[mm]	[mm]	[mm]	[mm]	[°]	[°]								
63A04R-SMORC16-C	63	47	22	18	-	50	10.4	6.3	-2.6	-7	4	-	9700	✓	0.61	GI280	C0033	-
66A05R-SMORC16-C	66	50	27	22	-	50	12.4	7	-2.5	-7	5	-	9200	✓	0.60	GI280	C0030	-
80A05R-SMORC16-C	80	64	27	37	-	50	12.4	7	-1.7	-7	5	-	8600	✓	0.88	GI280	C0030	-
100A06R-SMORC16-C	100	84	32	45	-	50	14.4	8	-1.7	-7	6	-	7700	✓	1.33	GI280	C0031	AC002
125A07R-SMORC16-C	125	109	40	36	-	63	16.4	9	-1.2	-7	7	-	6500	✓	3.07	GI280	C0032	-
160C08R-SMORC16-C	160	144	40	-	66.7	63	16.4	9	-0.9	-7	8	-	5400	✓	5.68	GI280	C0034	-

GI280	RCMT 1606M0..
-------	---------------

Coating	Insert	Torque (Nm)	Thread	Length	Key	Pin	Washer	Pin	Pin
C0030	US 65014-T20P	5.0	M 5	14	SDR T20P-T	HS 1230C	-	-	-
C0031	US 65014-T20P	5.0	M 5	14	SDR T20P-T	-	-	-	-
C0032	US 65014-T20P	5.0	M 5	14	SDR T20P-T	HSD 2040	-	-	-
C0033	US 65014-T20P	5.0	M 5	14	SDR T20P-T	HS 1030C	-	-	-
C0034	US 65014-T20P	5.0	M 5	14	SDR T20P-T	HS 1240C	CAC 160C	HSD 0825C	HXK 5

AC002	KS 1635	K.FMH32
-------	---------	---------



RCMT 16

	INSD	D1	S
	[mm]	[mm]	[mm]
1606	16.0	5.50	6.35

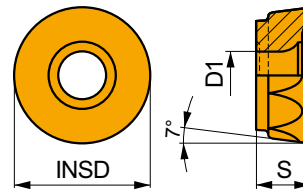

Suitability and starting values for cutting speed (vc), feed (f) and depth of cut (ap). Refer to our Machining Calculator app for further calculations.

Product	RE	P			M			K			N			S			H		
		vc	f	ap	vc	f	ap	vc	f	ap	vc	f	ap	vc	f	ap	vc	f	ap
	[mm]	[m/min]	[mm/tooth]	[mm]	[m/min]	[mm/tooth]	[mm]	[m/min]	[mm/tooth]	[mm]	[m/min]	[mm/tooth]	[mm]	[m/min]	[mm/tooth]	[mm]	[m/min]	[mm/tooth]	[mm]

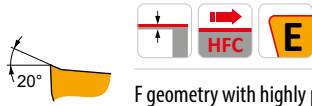

F geometry with highly positive design for light machining.

RCMT 1606MOEN-F	M8310	-	410	0.10	2.0	205	0.09	2.0	-	-	-	-	-	-	-	-	-	-	-
	M8330	-	370	0.10	2.0	220	0.09	2.0	-	-	-	-	-	-	90	0.07	1.6	-	-



M geometry with highly positive design for medium machining.

RCMT 1606MOSN-M	M6330	-	255	0.20	2.0	180	0.18	2.0	-	-	-	-	-	75	0.16	1.6	-	-	-	
	M8330	-	300	0.20	2.0	180	0.18	2.0	285	0.20	2.0	-	-	75	0.16	1.6	-	-	-	
	M8345	-	215	0.20	2.0	125	0.18	2.0	-	-	-	-	-	50	0.16	1.6	-	-	-	
	M9325	-	370	0.20	2.0	-	-	-	350	0.20	2.0	-	-	-	-	-	-	-	-	-
	M9340	-	335	0.20	2.0	200	0.18	2.0	-	-	-	-	-	80	0.16	1.6	-	-	-	



R geometry with positive design for rough copy machining.

RCMT 1606MOSN-R	M8310	-	250	0.40	2.0	-	-	-	235	0.40	2.0	-	-	-	-	-	50	0.15	1.0
	M8330	-	240	0.40	2.0	-	-	-	225	0.40	2.0	-	-	60	0.28	1.6	45	0.15	1.0
	M8345	-	175	0.40	2.0	-	-	-	-	-	-	-	-	40	0.28	1.6	-	-	-
	M9325	-	280	0.40	2.0	-	-	-	265	0.40	2.0	-	-	-	-	-	55	0.15	1.0



a_e / DCX	5 %	10 %	15 %	20 %	25 %	30 %	40 %	50 %	60 %	70 %	75 %	80 %	90 %	100 %
	1.48	1.35	1.27	1.22	1.19	1.16	1.11	1.08	1.05	1.03	1.00	1.00	1.00	1.00
	2.20	1.60	1.35	1.20	1.10	0.95	0.85	0.75	0.85	0.95	1.00	1.00	1.00	1.00
	0.64	0.64	0.64	0.64	0.64	0.65	0.65	0.67	0.68	0.71	0.72	0.74	0.79	1.00

	RCMT 16-F	RCMT 16-M	RCMT 16-R
	8.0	8.0	8.0
	-	-	-

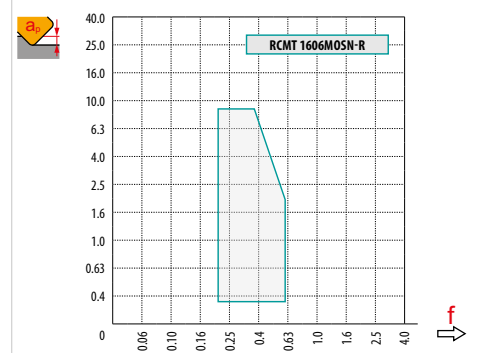
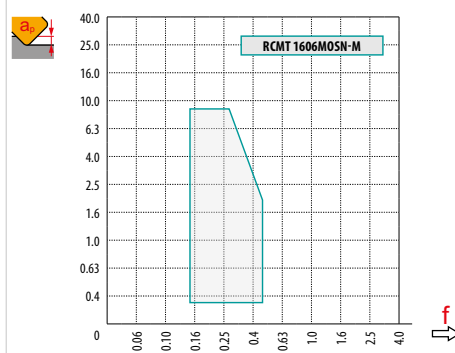
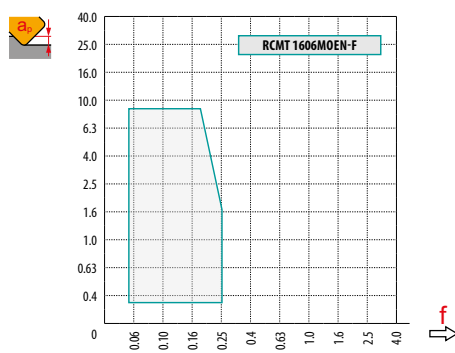







		0.00	0.30	0.50	0.75	1.00	1.25	1.50	2.00	2.50	3.00	4.00	5.00	6.00	7.00	8.00
63		47.0	51.3	52.6	53.8	54.7	55.6	56.3	57.6	58.6	59.5	60.9	61.8	62.5	62.9	63.0
66		50.0	54.3	55.6	56.8	57.8	58.6	59.3	60.6	61.6	62.5	63.9	64.8	65.5	65.9	66.0
80		64.0	68.3	69.6	70.8	71.7	72.6	73.3	74.6	75.6	76.5	77.9	78.8	79.5	79.9	80.0
100		84.0	88.3	89.6	90.8	91.7	92.6	93.3	94.6	95.6	96.5	97.9	98.8	99.5	99.9	100.0
125		109.0	113.3	114.6	115.8	116.7	117.6	118.3	119.6	120.6	121.5	122.9	123.8	124.5	124.9	125.0
160		144.0	148.3	149.6	150.8	151.7	152.6	153.3	154.6	155.6	156.5	157.9	158.8	159.5	159.9	160.0
		-	0.30	0.50	0.75	1.00	1.25	1.50	2.00	2.50	3.00	4.00	5.00	6.00	7.00	8.00
		-	1.10	0.85	0.70	0.61	0.54	0.50	0.43	0.39	0.36	0.31	0.28	0.26	0.25	0.24

	RPMX	APMX/I
63	7.0	8.0/67
66	6.5	8.0/71
80	5.0	8.0/93
100	4.0	6.8/100

	DMIN	DMAX		
63	94.0	126.0	8.0	8.0
66	100.0	132.0	8.0	8.0
80	128.0	160.0	8.0	8.0
100	168.0	200.0	8.0	8.0

5.0



		3	5	10	15	20	30	40	50	60	80	100
63		0.869	1.122	1.587	1.944	2.245	2.750	3.175	3.550	3.888	4.490	5.020
66		0.890	1.149	1.625	1.990	2.298	2.814	3.250	3.633	3.980	4.596	5.138
80		0.980	1.265	1.789	2.191	2.530	3.098	3.578	4.000	4.382	5.060	5.657
100		1.095	1.414	2.000	2.449	2.828	3.464	4.000	4.472	4.899	5.657	6.325
125		1.225	1.581	2.236	2.739	3.162	3.873	4.472	5.000	5.477	6.325	7.071
160		1.386	1.789	2.530	3.098	3.578	4.382	5.060	5.657	6.197	7.155	8.000
		3	5	10	15	20	30	40	50	60	80	100
8.0		0.438	0.566	0.800	0.980	1.131	1.386	1.600	1.789	1.960	2.263	2.530

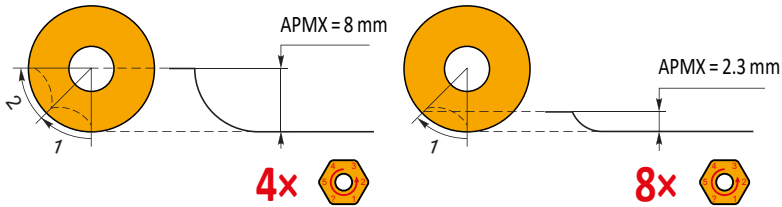



SRC20



PRAMET

S



Copy Milling Cutter for Round Inserts RCMT 20 with Internal Coolant

Milling cutter for heavy copy milling utilising positive RCMT 16 inserts with APMX of 10 mm. Internal coolant. Suitable for face, helical interpolation, ramping, progressive plunge and high-feed milling. Available in arbor style in range Ø80 up to Ø160 mm. Body treated for longer tool life.

APMX	10.0 mm
------	---------

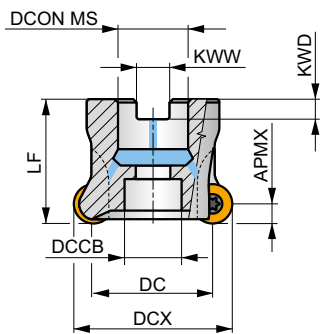
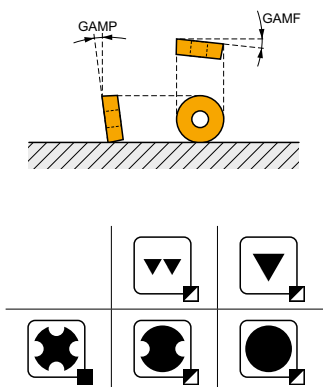

DC 80 - 125 mm

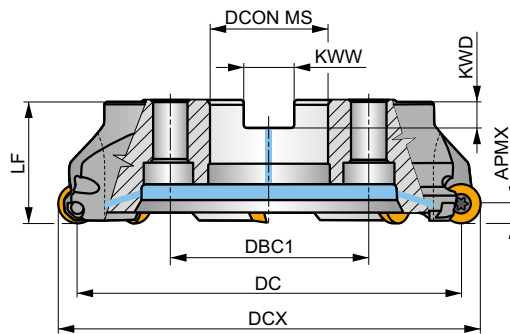

DC 160 mm

0.11 - 0.32



Product	DCX	DC	DCON MS	DCCB	DBC1	LF	KWW	KWD	GAMF	GAMP								
	[mm]	[mm]	[mm]	[mm]	[mm]	[mm]	[mm]	[mm]	[°]	[°]								
80A04R-SMORC20-C	80	60	27	28	-	50	12.4	7	-2.7	-7	4	-	8500	✓	0.96	GI281	C0040	-
100A05R-SMORC20-C	100	80	32	45	-	50	14.4	8	-1.7	-7	5	-	7600	✓	1.26	GI281	C0041	AC002
125A06R-SMORC20-C	125	105	40	36	-	63	16.4	9	-1	-7	6	-	6500	✓	2.96	GI281	C0042	-
160C07R-SMORC20-C	160	140	40	-	66.7	63	16.4	9	-0.9	-7	7	-	5400	✓	5.44	GI281	C0046	-

	GI281		RCMT 2006MO..
--	-------	--	---------------

C0040	US 66015-T25P	7.5	M 6	15	SDR T25P-T	HS 1230C	-	-	-
C0041	US 66015-T25P	7.5	M 6	15	SDR T25P-T	-	-	-	-
C0042	US 66015-T25P	7.5	M 6	15	SDR T25P-T	HSD 2040	-	-	-
C0046	US 66015-T25P	7.5	M 6	15	SDR T25P-T	HS 1240C	CAC 160C	HSD 0825C	HXX 5

	AC002		KS 1635		K.FMH32
--	-------	--	---------	--	---------



RCMT 20

	INSD	D1	S
	[mm]	[mm]	[mm]
2006	20.0	6.50	6.35

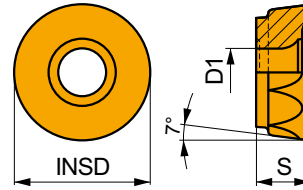

Suitability and starting values for cutting speed (vc), feed (f) and depth of cut (ap). Refer to our Machining Calculator app for further calculations.

Product	RE	P			M			K			N			S			H		
		vc	f	ap	vc	f	ap	vc	f	ap	vc	f	ap	vc	f	ap	vc	f	ap
	[mm]	[m/min]	[mm/tooth]	[mm]	[m/min]	[mm/tooth]	[mm]	[m/min]	[mm/tooth]	[mm]	[m/min]	[mm/tooth]	[mm]	[m/min]	[mm/tooth]	[mm]	[m/min]	[mm/tooth]	[mm]

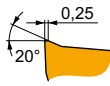

F geometry with highly positive design for light machining.

RCMT 2006MOSN-F	M8330	-	320	0.15	3.0	190	0.14	3.0	-	-	-	-	-	-	80	0.11	2.4	-	-	-
------------------------	--------------	---	-----	------	-----	-----	------	-----	---	---	---	---	---	---	----	------	-----	---	---	---

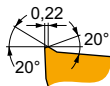

M geometry with highly positive design for medium machining.

RCMT 2006MOSN-M	M6330	-	225	0.30	3.0	155	0.27	3.0	-	-	-	-	-	-	65	0.21	2.4	-	-	-	
	M8330	-	255	0.30	3.0	150	0.27	3.0	240	0.30	3.0	-	-	-	60	0.21	2.4	-	-	-	
	M8345	-	190	0.30	3.0	110	0.27	3.0	-	-	-	-	-	-	45	0.21	2.4	-	-	-	
	M9315	-	330	0.30	3.0	-	-	-	310	0.30	3.0	-	-	-	-	-	-	-	-	-	-
	M9325	-	315	0.30	3.0	-	-	-	295	0.30	3.0	-	-	-	-	-	-	-	-	-	-
M9340	-	275	0.30	3.0	165	0.27	3.0	-	-	-	-	-	-	65	0.21	2.4	-	-	-		

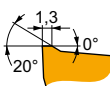

R geometry with positive design for rough copy machining.

RCMT 2006MOSN-R	M8330	-	225	0.45	3.0	-	-	-	210	0.45	3.0	-	-	-	55	0.32	2.4	45	0.15	1.0
	M8345	-	165	0.45	3.0	-	-	-	-	-	-	-	-	-	40	0.32	2.4	-	-	-
	M9325	-	260	0.45	3.0	-	-	-	245	0.45	3.0	-	-	-	-	-	-	50	0.15	1.0



a_e / DCX	5 %	10 %	15 %	20 %	25 %	30 %	40 %	50 %	60 %	70 %	75 %	80 %	90 %	100 %
	1.48	1.35	1.27	1.22	1.19	1.16	1.11	1.08	1.05	1.03	1.00	1.00	1.00	1.00
	2.20	1.60	1.35	1.20	1.10	0.95	0.85	0.75	0.85	0.95	1.00	1.00	1.00	1.00
	0.64	0.64	0.64	0.64	0.64	0.65	0.65	0.67	0.68	0.71	0.72	0.74	0.79	1.00

	RCMT 20-F	RCMT 20-M	RCMT 20-R
	10.0	10.0	10.0
	-	-	-

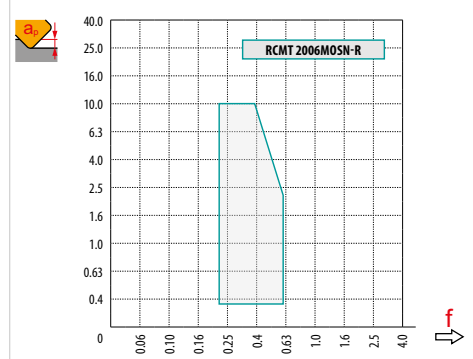
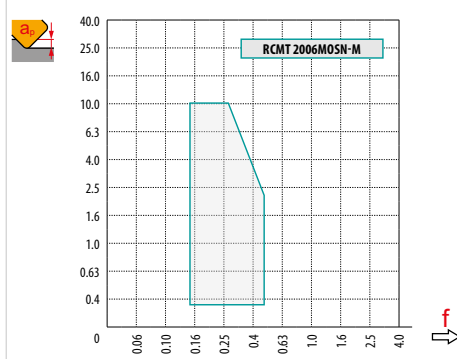
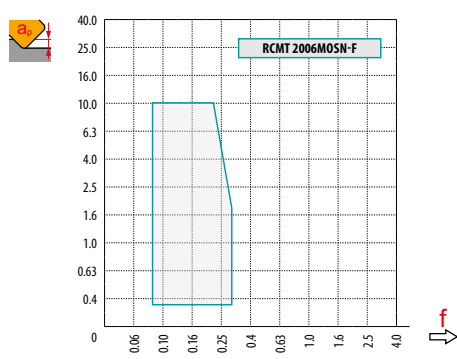







		0.00	0.30	0.50	0.75	1.00	1.25	1.50	2.00	2.50	3.00	4.00	5.00	6.00	7.00	8.00	9.00	10.00
80		60.0	64.9	66.2	67.6	68.7	69.7	70.5	72.0	73.2	74.3	76.0	77.3	78.3	79.1	79.6	79.9	80.0
100		80.0	84.9	86.2	87.6	88.7	89.7	90.5	92.0	93.2	94.3	96.0	97.3	98.3	99.1	99.6	99.9	100.0
125		105.0	109.9	111.2	112.6	113.7	114.7	115.5	117.0	118.2	119.3	121.0	122.3	123.3	124.1	124.6	124.9	125.0
160		140.0	144.9	146.2	147.6	148.7	149.7	150.5	152.0	153.2	154.3	156.0	157.3	158.3	159.1	159.6	159.9	160.0
		-	0.30	0.50	0.75	1.00	1.25	1.50	2.00	2.50	3.00	4.00	5.00	6.00	7.00	8.00	9.00	10.00
		-	1.23	0.95	0.78	0.68	0.61	0.55	0.48	0.43	0.40	0.35	0.31	0.29	0.27	0.26	0.25	0.24

	RPMX	APMX/I
80	7.0	10.0/83
100	5.0	8.6/100

	DMIN	DMAX		
80	120.0	160.0	10.0	10.0
100	160.0	200.0	10.0	10.0

6.0



		3	5	10	15	20	30	40	50	60	80	100
80		0.980	1.265	1.789	2.191	2.530	3.098	3.578	4.000	4.382	5.060	5.657
100		1.095	1.414	2.000	2.449	2.828	3.464	4.000	4.472	4.899	5.657	6.325
125		1.225	1.581	2.236	2.739	3.162	3.873	4.472	5.000	5.477	6.325	7.071
160		1.386	1.789	2.530	3.098	3.578	4.382	5.060	5.657	6.197	7.155	8.000
		3	5	10	15	20	30	40	50	60	80	100
10.0		0.490	0.632	0.894	1.095	1.265	1.549	1.789	2.000	2.191	2.530	2.828

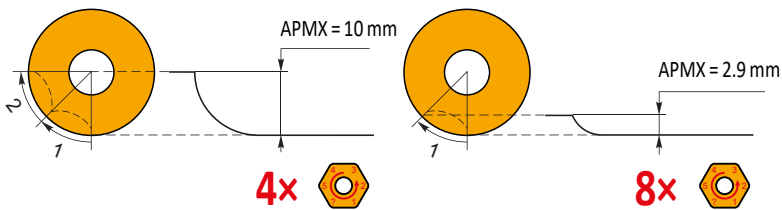



SRD05



PRAMET

S



Copy Milling Cutter for Round Inserts RDHX 05 with Internal Coolant

Milling cutter for copy milling utilising positive RDHX 05 inserts with APMX of 1.5 mm. Internal coolant. Suitable for face, helical interpolation, ramping, progressive plunge and copy milling. Available as modular style in range Ø10 up to Ø15 mm. Body treated for longer tool life.

APMX	1.5 mm
------	--------

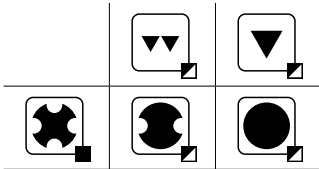
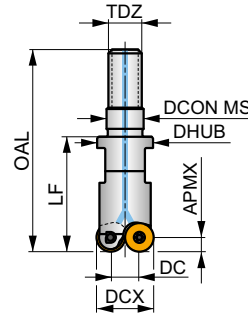
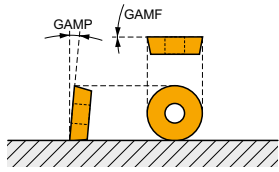

h_m 0.03 - 0.1



Product	DCX	DC	DHUB	OAL	LF	DCON MS	TDZ	GAMF	GAMP							
	[mm]	[mm]	[mm]	[mm]	[mm]	[mm]		[°]	[°]							
10E2R020M06-SRD05-CF	10	5	9.8	35	20	6.5	M6	5	3	2	-	89300	✓	0.01	GI117	C0352
12E3R020M06-SRD05-CF	12	7	10	35	20	6.5	M6	0	3	3	-	81500	✓	0.01	GI117	C0352
15E4R020M08-SRD05-CF	15	10	13.5	38	20	8.5	M8	0	3	4	-	72900	✓	0.02	GI117	C0352

GI117	RD..0501M0..

C0352	US 62003B-T06P	0.9	M 2	3	Flag T06P



RDHX 05

	INSD	D1	S
	[mm]	[mm]	[mm]
0501	5.0	2.20	1.51

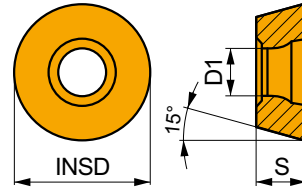

Suitability and starting values for cutting speed (vc), feed (f) and depth of cut (ap). Refer to our Machining Calculator app for further calculations.

Product	RE [mm]	P			M			K			N			S			H		
		vc [m/min]	f [mm/tooth]	ap [mm]	vc [m/min]	f [mm/tooth]	ap [mm]	vc [m/min]	f [mm/tooth]	ap [mm]	vc [m/min]	f [mm/tooth]	ap [mm]	vc [m/min]	f [mm/tooth]	ap [mm]			

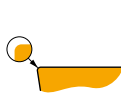

Zero rake angle design for finish machining.

RDHX 0501MOE	M8310	-	<input checked="" type="checkbox"/>	400	0.10	0.5	-	-	-	380	0.10	0.5	-	-	-	-	-	-	80	0.15	1.0
---------------------	--------------	---	-------------------------------------	-----	------	-----	---	---	---	-----	------	-----	---	---	---	---	---	---	----	------	-----



a_e / DCX	5 %	10 %	15 %	20 %	25 %	30 %	40 %	50 %	60 %	70 %	75 %	80 %	90 %	100 %
	1.48	1.35	1.27	1.22	1.19	1.16	1.11	1.08	1.05	1.03	1.00	1.00	1.00	1.00
	2.20	1.60	1.35	1.20	1.10	0.95	0.85	0.75	0.85	0.95	1.00	1.00	1.00	1.00
	0.64	0.64	0.64	0.64	0.64	0.65	0.65	0.67	0.68	0.71	0.72	0.74	0.79	1.00

	RDHX 05
	2.5
	-

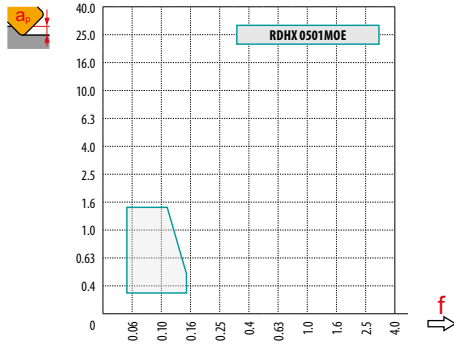

		0.00	0.30	0.50	0.75	1.00	1.25	1.50	2.00	2.50
10		5.0	7.4	8.0	8.6	9.0	9.3	9.6	9.9	10.0
12		7.0	9.4	10.0	10.6	11.0	11.3	11.6	11.9	12.0
15		10.0	12.4	13.0	13.6	14.0	14.3	14.6	14.9	15.0
		-	0.30	0.50	0.75	1.00	1.25	1.50	2.00	2.50
		-	0.25	0.19	0.16	0.14	0.13	0.12	0.10	0.09

	RPMX	APMX/I
10	15.0	1.3/11
12	11.0	1.3/14
15	7.0	1.3/22

	DMIN	DMAX		
10	12.0	20.0	1.2	1.2
12	16.0	24.0	1.2	1.2
15	22.0	30.0	1.2	1.2

1.0

	μm	3	5	10	15	20	30	40	50	60	80	100
10		0.346	0.447	0.632	0.775	0.894	1.095	1.265	1.414	1.549	1.789	2.000
12		0.379	0.490	0.693	0.849	0.980	1.200	1.386	1.549	1.697	1.960	2.191
15		0.424	0.548	0.775	0.949	1.095	1.342	1.549	1.732	1.897	2.191	2.449
	μm	3	5	10	15	20	30	40	50	60	80	100
2.5		0.245	0.316	0.447	0.548	0.632	0.775	0.894	1.000	1.095	1.265	1.414

	μm	3	5	10	15	20	30	40	50	60	80	100
10		0.346	0.447	0.632	0.775	0.894	1.095	1.265	1.414	1.549	1.789	2.000
12		0.379	0.490	0.693	0.849	0.980	1.200	1.386	1.549	1.697	1.960	2.191
15		0.424	0.548	0.775	0.949	1.095	1.342	1.549	1.732	1.897	2.191	2.449
	μm	3	5	10	15	20	30	40	50	60	80	100
2.5		0.245	0.316	0.447	0.548	0.632	0.775	0.894	1.000	1.095	1.265	1.414



SRD07

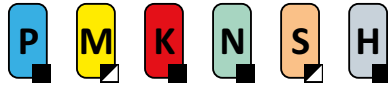

PRAMET



Copy Milling Cutter for Round Inserts RD.. 07 with Internal Coolant

Milling cutter for copy milling utilising positive RD.. 07 inserts with APMX of 2.0 mm. Internal coolant. Suitable for face, helical interpolation, ramping, progressive plunge and copy milling. Available in Weldon and modular style, in range Ø15 up to Ø25 mm. Body treated for longer tool life.

APMX	2.0 mm
------	--------

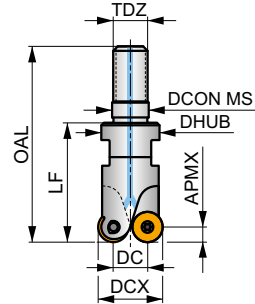
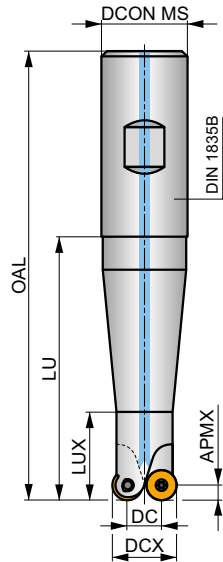
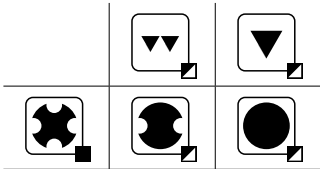
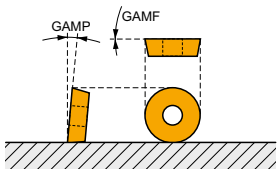

h_m 0.065 - 0.13



Product	DCX	DC	OAL	D CON MS	DHUB	LU	LUX	LF	TDZ	GAMF	GAMP	Inserts		max.	kg	Tools		
	[mm]	[mm]	[mm]	[mm]	[mm]	[mm]	[mm]	[mm]	[mm]	[°]	[°]	Ø	Ø			Ø	Ø	
DIN 1835B	15E2R040B16-SRD07-CF	15	8	88	16	-	40	20	-	-	1	0	2	-	44200	✓	0.10	GI118 C0354
	15E2R060B16-SRD07-CF	15	8	108	16	-	60	20	-	-	1	0	2	-	44200	✓	0.13	GI118 C0354
	15E2R080B20-SRD07-CF	15	8	130	20	-	80	22	-	-	1	0	2	-	44200	✓	0.22	GI118 C0354
	15E2R100B20-SRD07-CF	15	8	150	20	-	100	22	-	-	1	0	2	-	44200	✓	0.25	GI118 C0354
	15E2R120B25-SRD07-CF	15	8	176	25	-	120	22	-	-	1	0	2	-	44200	✓	0.43	GI118 C0354
MODULAR	15E2R028M08-SRD07-CF	15	8	46	8.5	13.5	-	28	M8	1	0	2	-	44200	✓	0.03	GI118 C0354	
	15E3R028M08-SRD07-CF	15	8	46	10.5	13.5	-	28	M8	2	0	3	-	44200	✓	0.03	GI118 C0354	
	20E4R028M10-SRD07-CF	20	13	47	12.5	18	-	28	M10	-8	0	4	-	38200	✓	0.05	GI118 C0354	
	25E5R028M12-SRD07-CF	25	18	50	12.5	21	-	28	M12	-2	0	5	-	34200	✓	0.08	GI118 C0354	

GI118	RD.. 0702M0..
-------	---------------

C0354	US 42505-T07P	1.2 Nm	M 2.5	5	Flag T07P
-------	---------------	--------	-------	---	-----------



RDHX 07

PRAMET

	INSD	D1	S
	[mm]	[mm]	[mm]
0702	7.0	2.80	2.38
07T1	7.0	2.80	1.98

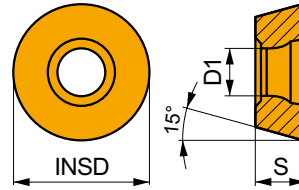

Suitability and starting values for cutting speed (vc), feed (f) and depth of cut (ap). Refer to our Machining Calculator app for further calculations.

Product	RE	P			M			K			N			S			H		
		vc	f	ap	vc	f	ap	vc	f	ap	vc	f	ap	vc	f	ap	vc	f	ap
	[mm]	[m/min]	[mm/tooth]	[mm]	[m/min]	[mm/tooth]	[mm]	[m/min]	[mm/tooth]	[mm]	[m/min]	[mm/tooth]	[mm]	[m/min]	[mm/tooth]	[mm]	[m/min]	[mm/tooth]	[mm]

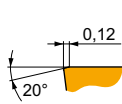

Zero rake angle design for finish machining.

RDHX 0702MOT	M4303	–	370	0.15	0.5	–	–	–	350	0.15	0.5	–	–	–	–	–	–	–	–	70	0.15	1.0
	M8310	–	360	0.15	0.5	–	–	–	340	0.15	0.5	–	–	–	–	–	–	–	–	70	0.15	1.0
	M8325	–	275	0.15	0.5	–	–	–	–	–	–	–	–	–	–	–	–	–	–	–	–	–
RDHX 07T1MOT	M8310	–	360	0.15	0.5	–	–	–	340	0.15	0.5	–	–	–	–	–	–	–	–	70	0.15	1.0
	M8325	–	275	0.15	0.5	–	–	–	–	–	–	–	–	–	–	–	–	–	–	–	–	–

RDGT 07

PRAMET

	INSD	D1	S
	[mm]	[mm]	[mm]
0702	7.0	2.80	2.38

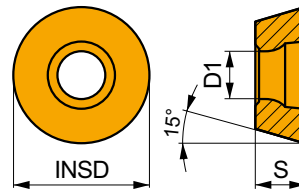

Suitability and starting values for cutting speed (vc), feed (f) and depth of cut (ap). Refer to our Machining Calculator app for further calculations.

Product	RE	P			M			K			N			S			H		
		vc	f	ap	vc	f	ap	vc	f	ap	vc	f	ap	vc	f	ap	vc	f	ap
	[mm]	[m/min]	[mm/tooth]	[mm]	[m/min]	[mm/tooth]	[mm]	[m/min]	[mm/tooth]	[mm]	[m/min]	[mm/tooth]	[mm]	[m/min]	[mm/tooth]	[mm]	[m/min]	[mm/tooth]	[mm]

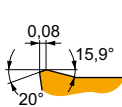

Positive design for finish machining.

RDGT 0702MOT	M8310	–	400	0.15	0.5	200	0.14	0.5	380	0.15	0.5	–	–	–	–	–	–	–	–	–	–	–
	M8325	–	305	0.15	0.5	145	0.14	0.5	–	–	–	–	–	–	–	–	–	–	–	–	–	–
	M8345	–	270	0.15	0.5	160	0.14	0.5	–	–	–	–	–	–	65	0.12	0.4	–	–	–	–	–



RDHT 07-FA

	INSD	D1	S
	[mm]	[mm]	[mm]
0702	7.0	2.80	2.38

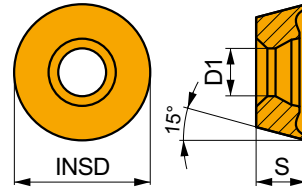

Suitability and starting values for cutting speed (vc), feed (f) and depth of cut (ap). Refer to our Machining Calculator app for further calculations.

Product	RE	P			M			K			N			S			H			
		vc	f	ap	vc	f	ap	vc	f	ap	vc	f	ap	vc	f	ap	vc	f	ap	
	[mm]	[m/min]	[mm/tooth]	[mm]	[m/min]	[mm/tooth]	[mm]	[m/min]	[mm/tooth]	[mm]	[m/min]	[mm/tooth]	[mm]	[m/min]	[mm/tooth]	[mm]	[m/min]	[mm/tooth]	[mm]	

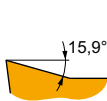

FA geometry with highly positive design for fine-finish to medium machining.

RDHT 0702M0-FA	HF7	-	-	-	-	-	-	-	-	-	420	0.18	0.5	-	-	-	-	-	-
----------------	-----	---	---	---	---	---	---	---	---	---	-----	------	-----	---	---	---	---	---	---

RDMT 07

	INSD	D1	S
	[mm]	[mm]	[mm]
0702	7.0	2.80	2.38

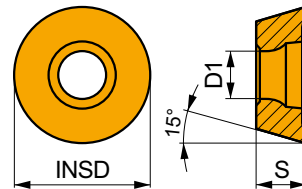

Suitability and starting values for cutting speed (vc), feed (f) and depth of cut (ap). Refer to our Machining Calculator app for further calculations.

Product	RE	P			M			K			N			S			H			
		vc	f	ap	vc	f	ap	vc	f	ap	vc	f	ap	vc	f	ap	vc	f	ap	
	[mm]	[m/min]	[mm/tooth]	[mm]	[m/min]	[mm/tooth]	[mm]	[m/min]	[mm/tooth]	[mm]	[m/min]	[mm/tooth]	[mm]	[m/min]	[mm/tooth]	[mm]	[m/min]	[mm/tooth]	[mm]	

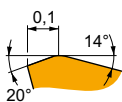

Positive design for finish machining.

RDMT 0702M0T	M8325	-	305	0.15	0.5	145	0.14	0.5	-	-	-	-	-	-	-	-	-	-	-
--------------	-------	---	-----	------	-----	-----	------	-----	---	---	---	---	---	---	---	---	---	---	---



a_e DCX	5 %	10 %	15 %	20 %	25 %	30 %	40 %	50 %	60 %	70 %	75 %	80 %	90 %	100 %
	1.48	1.35	1.27	1.22	1.19	1.16	1.11	1.08	1.05	1.03	1.00	1.00	1.00	1.00
	2.20	1.60	1.35	1.20	1.10	0.95	0.85	0.75	0.85	0.95	1.00	1.00	1.00	1.00
	0.64	0.64	0.64	0.64	0.64	0.65	0.65	0.67	0.68	0.71	0.72	0.74	0.79	1.00

	RDHX 07	RDGT 07	RDHT 07-FA
	3.5	3.5	3.5
	-	-	-

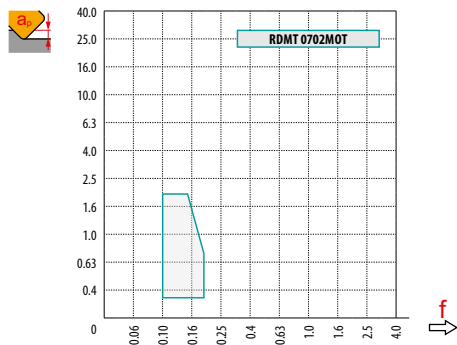
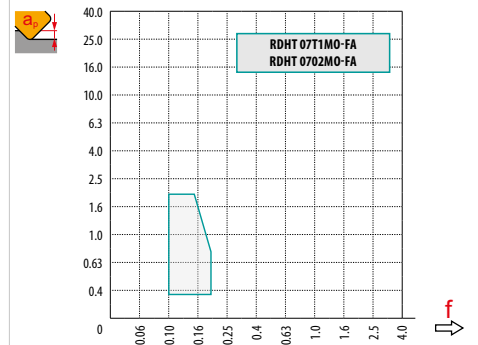
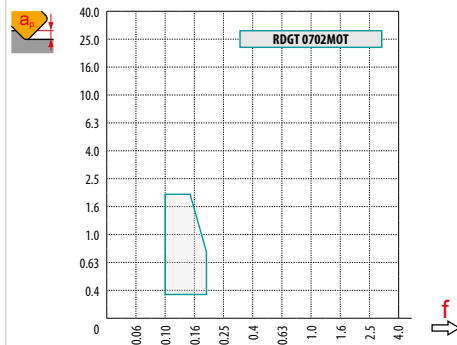
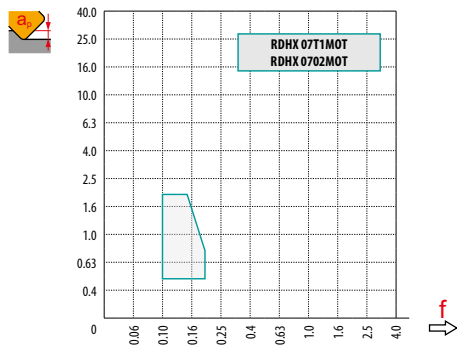

		0.00	0.30	0.50	0.75	1.00	1.25	1.50	2.00	2.50	3.00	3.50
15		8.0	10.8	11.6	12.3	12.9	13.4	13.7	14.3	14.7	14.9	15.0
20		13.0	15.8	16.6	17.3	17.9	18.4	18.7	19.3	19.7	19.9	20.0
25		18.0	20.8	21.6	22.3	22.9	23.4	23.7	24.3	24.7	24.9	25.0
		0.00	0.30	0.50	0.75	1.00	1.25	1.50	2.00	2.50	3.00	3.50
		-	0.29	0.23	0.19	0.16	0.15	0.13	0.12	0.11	0.10	0.09

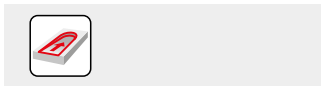

15	11.0	1.7/20
20	7.0	1.7/30
25	6.0	1.7/35

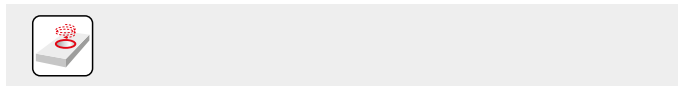

	DMIN	DMAX		
15	17.0	30.0	0.4	1.7
20	28.0	40.0	1.7	1.7
25	38.0	50.0	1.7	1.7

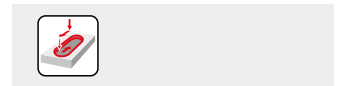

	1.2
--	-----

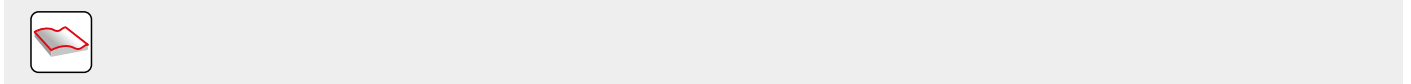

		3	5	10	15	20	30	40	50	60	80	100
15		0.424	0.548	0.775	0.949	1.095	1.342	1.549	1.732	1.897	2.191	2.449
20		0.490	0.632	0.894	1.095	1.265	1.549	1.789	2.000	2.191	2.530	2.828
25		0.548	0.707	1.000	1.225	1.414	1.732	2.000	2.236	2.449	2.828	3.162
		3	5	10	15	20	30	40	50	60	80	100
3.5		0.290	0.374	0.529	0.648	0.748	0.917	1.058	1.183	1.296	1.497	1.673



SRD10



PRAMET

S



Copy Milling Cutter for Round Inserts RD.. 10 with Internal Coolant

Milling cutter for copy milling utilising positive RD.. 10 inserts with APMX of 2.5 mm. Internal coolant. Suitable for face, helical interpolation, ramping, progressive plunge and copy milling. Available in Weldon, modular and arbor style, in range Ø20 up to Ø52 mm. Body treated for longer tool life.

APMX	2.5 mm
------	--------

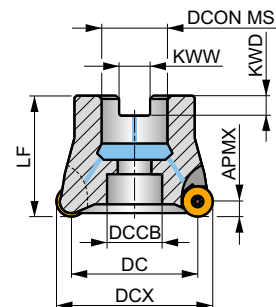
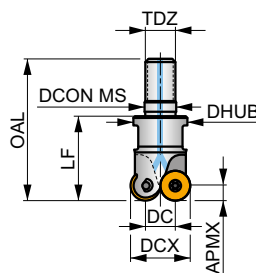
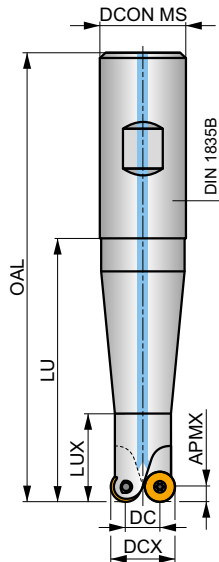
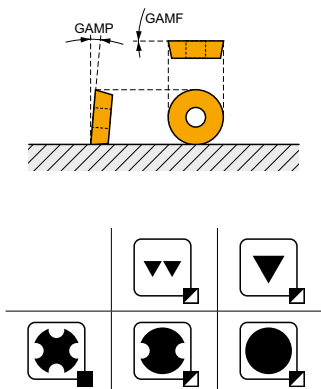

h_m 0.065 - 0.19



Product	DCX	DC	OAL	DCON MS	DHUB	DCCB	LU	LUX	LF	TDZ	KWW	KWD	GAMF	GAMP	max.			kg	G119		
	[mm]	[mm]	[mm]	[mm]	[mm]	[mm]	[mm]	[mm]	[mm]	[mm]	[mm]	[mm]	[°]	[°]							
20E2R040B20-SRD10-CF	20	10	90	20	-	-	40	20	-	-	-	-	-2	0	2	-	30800	✓	0.17	G119	C0356
20E2R060B20-SRD10-CF	20	10	110	20	-	-	60	22	-	-	-	-	-2	0	2	-	30800	✓	0.20	G119	C0356
20E2R080B25-SRD10-CF	20	10	136	25	-	-	80	25	-	-	-	-	-2	0	2	-	30800	✓	0.36	G119	C0356
20E2R100B25-SRD10-CF	20	10	156	25	-	-	100	25	-	-	-	-	-2	0	2	-	30800	✓	0.41	G119	C0356
20E2R120B25-SRD10-CF	20	10	176	25	-	-	120	25	-	-	-	-	-2	0	2	-	30800	✓	0.46	G119	C0356
20E2R028M10-SRD10-CF	20	10	47	10.5	18	-	-	28	M10	-	-	-	-2	0	2	-	30800	✓	0.07	G119	C0356
25E2R032M12-SRD10-CF	25	15	54	12.5	21	-	-	32	M12	-	-	0.5	0.5	2	-	27500	✓	0.08	G119	C0356	
25E3R032M12-SRD10-CF	25	15	54	12.5	21	-	-	32	M12	-	-	0.5	0.5	3	-	27500	✓	0.08	G119	C0356	
30E4R042M16-SRD10-CF	30	20	65	17	29	-	-	42	M16	-	-	0	0	4	-	25100	✓	0.18	G119	C0356	
32E4R042M16-SRD10-CF	32	22	65	17	29	-	-	42	M16	-	-	0	0	4	-	24300	✓	0.19	G119	C0356	
35E5R042M16-SRD10-CF	35	25	65	17	29	-	-	42	M16	-	-	0	0	5	-	23200	✓	0.20	G119	C0356	
42E4R042M16-SRD10-CF	42	32	65	17	29	-	-	42	M16	-	-	0	0	4	-	21200	✓	0.24	G119	C0356	
42E5R042M16-SRD10-CF	42	32	65	17	29	-	-	42	M16	-	-	0	0	5	-	21200	✓	0.24	G119	C0356	
42A05R-SMORD10-CF	42	32	-	16	-	14	-	40	-	8.4	8.4	0	0	5	-	21200	✓	0.20	G119	C0358	
52A07R-SMORD10-CF	52	42	-	22	-	18	-	40	-	10.4	10.4	0	0	7	-	19100	✓	0.28	G119	C0360	

G119	RD.. 1003MOT	RDHT 1003MO-FA

C0356	US 63507-T15P	3.0	M 3.5	7	Flag T15P	-
C0358	US 63507-T15P	3.0	M 3.5	7	D-T08P/T15P	FG-15
C0360	US 63507-T15P	3.0	M 3.5	7	D-T08P/T15P	FG-15



RDHX 10

	INSD	D1	S
	[mm]	[mm]	[mm]
1003	10.0	3.90	3.18

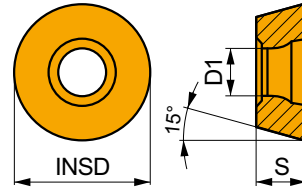

Suitability and starting values for cutting speed (vc), feed (f) and depth of cut (ap). Refer to our Machining Calculator app for further calculations.

Product	RE	P			M			K			N			S			H		
		vc	f	ap	vc	f	ap	vc	f	ap	vc	f	ap	vc	f	ap	vc	f	ap
	[mm]	[m/min]	[mm/tooth]	[mm]	[m/min]	[mm/tooth]	[mm]	[m/min]	[mm/tooth]	[mm]	[m/min]	[mm/tooth]	[mm]	[m/min]	[mm/tooth]	[mm]	[m/min]	[mm/tooth]	[mm]

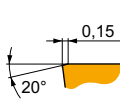

Zero rake angle design for finish machining.

RDHX 1003MOT	M4303	–	☑	340	0.15	1.0	–	–	–	■	320	0.15	1.0	–	–	–	–	–	–	■	65	0.15	1.0
	M8310	–	☑	335	0.15	1.0	–	–	–	■	315	0.15	1.0	–	–	–	–	–	–	■	65	0.15	1.0
	M8325	–	☑	250	0.15	1.0	–	–	–	–	–	–	–	–	–	–	–	–	–	–	–	–	–
	M8330	–	☑	305	0.15	1.0	–	–	–	■	285	0.15	1.0	–	–	–	–	–	–	☑	60	0.15	1.0
	M8345	–	☑	225	0.15	1.0	–	–	–	–	–	–	–	–	–	–	–	–	–	–	–	–	–

RDMX 10

	INSD	D1	S
	[mm]	[mm]	[mm]
1003	10.0	3.90	3.18

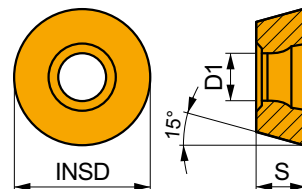

Suitability and starting values for cutting speed (vc), feed (f) and depth of cut (ap). Refer to our Machining Calculator app for further calculations.

Product	RE	P			M			K			N			S			H		
		vc	f	ap	vc	f	ap	vc	f	ap	vc	f	ap	vc	f	ap	vc	f	ap
	[mm]	[m/min]	[mm/tooth]	[mm]	[m/min]	[mm/tooth]	[mm]	[m/min]	[mm/tooth]	[mm]	[m/min]	[mm/tooth]	[mm]	[m/min]	[mm/tooth]	[mm]	[m/min]	[mm/tooth]	[mm]

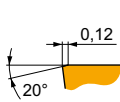
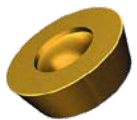

Zero rake angle design for finish machining.

RDMX 1003MOT	M8310	–	☑	335	0.15	1.0	–	–	–	■	315	0.15	1.0	–	–	–	–	–	–	■	65	0.15	1.0
	M8325	–	☑	250	0.15	1.0	–	–	–	–	–	–	–	–	–	–	–	–	–	–	–	–	–
	M8345	–	☑	225	0.15	1.0	–	–	–	–	–	–	–	–	–	–	–	–	–	–	–	–	–



RDGT 10

PRAMET

	INSD	D1	S
	[mm]	[mm]	[mm]
1003	10.0	3.90	3.18

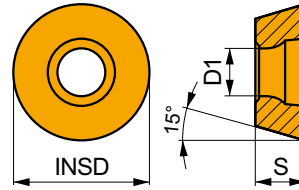

Suitability and starting values for cutting speed (vc), feed (f) and depth of cut (ap). Refer to our Machining Calculator app for further calculations.

Product	RE	P			M			K			N			S			H		
		vc	f	ap	vc	f	ap	vc	f	ap	vc	f	ap	vc	f	ap	vc	f	ap
	[mm]	[m/min]	[mm/tooth]	[mm]	[m/min]	[mm/tooth]	[mm]	[m/min]	[mm/tooth]	[mm]	[m/min]	[mm/tooth]	[mm]	[m/min]	[mm/tooth]	[mm]	[m/min]	[mm/tooth]	[mm]

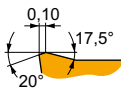

Positive design for finish machining.

RDGT 1003MOT	M6330	-	■	290	0.15	1.0	■	205	0.14	1.0	-	-	-	■	85	0.12	0.8	-	-	-
	M8310	-	■	375	0.15	1.0	■	190	0.14	1.0	■	355	0.15	1.0	-	-	-	-	-	-
	M8325	-	■	280	0.15	1.0	■	130	0.14	1.0	-	-	-	-	-	-	-	-	-	-
	M8345	-	■	250	0.15	1.0	■	150	0.14	1.0	-	-	-	■	60	0.12	0.8	-	-	-
	M9340	-	■	395	0.15	1.0	■	235	0.14	1.0	-	-	-	■	95	0.12	0.8	-	-	-

RDHT 10-FA

PRAMET

	INSD	D1	S
	[mm]	[mm]	[mm]
1003	10.0	3.90	3.18

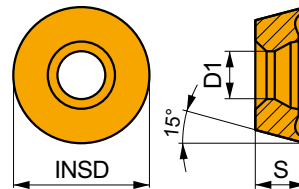

Suitability and starting values for cutting speed (vc), feed (f) and depth of cut (ap). Refer to our Machining Calculator app for further calculations.

Product	RE	P			M			K			N			S			H		
		vc	f	ap	vc	f	ap	vc	f	ap	vc	f	ap	vc	f	ap	vc	f	ap
	[mm]	[m/min]	[mm/tooth]	[mm]	[m/min]	[mm/tooth]	[mm]	[m/min]	[mm/tooth]	[mm]	[m/min]	[mm/tooth]	[mm]	[m/min]	[mm/tooth]	[mm]	[m/min]	[mm/tooth]	[mm]

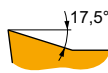

FA geometry with highly positive design for fine-finish to medium machining.

RDHT 1003MO-FA	HF7	-	-	-	-	-	-	-	-	-	■	390	0.18	1.0	-	-	-	-	-	-
----------------	-----	---	---	---	---	---	---	---	---	---	---	-----	------	-----	---	---	---	---	---	---



RDMT 10

	INSD	D1	S
	[mm]	[mm]	[mm]
1003	10.0	3.90	3.18

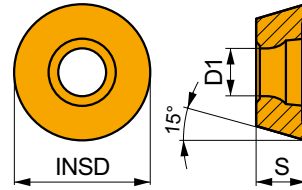

Suitability and starting values for cutting speed (vc), feed (f) and depth of cut (ap). Refer to our Machining Calculator app for further calculations.

Product	RE [mm]	P			M			K			N			S			H		
		vc [m/min]	f [mm/tooth]	ap [mm]	vc [m/min]	f [mm/tooth]	ap [mm]	vc [m/min]	f [mm/tooth]	ap [mm]	vc [m/min]	f [mm/tooth]	ap [mm]	vc [m/min]	f [mm/tooth]	ap [mm]	vc [m/min]	f [mm/tooth]	ap [mm]

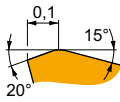

Positive design for finish machining.

RDMT 1003MOT	M8325	-	■	280	0.15	1.0	▣	130	0.14	1.0	■	-	-	-	■	-	-	-	■	-	-	-
	M8345	-	■	250	0.15	1.0	▣	150	0.14	1.0	■	-	-	-	■	-	-	-	■	-	-	-



a_e / DCX	5 %	10 %	15 %	20 %	25 %	30 %	40 %	50 %	60 %	70 %	75 %	80 %	90 %	100 %
	1.48	1.35	1.27	1.22	1.19	1.16	1.11	1.08	1.05	1.03	1.00	1.00	1.00	1.00
	2.20	1.60	1.35	1.20	1.10	0.95	0.85	0.75	0.85	0.95	1.00	1.00	1.00	1.00
	0.64	0.64	0.64	0.64	0.64	0.65	0.65	0.67	0.68	0.71	0.72	0.74	0.79	1.00

	RDHX 10	RDMX 10	RDGT 10	RDHT 10-FA
	5.0	5.0	5.0	5.0
	-	-	-	-

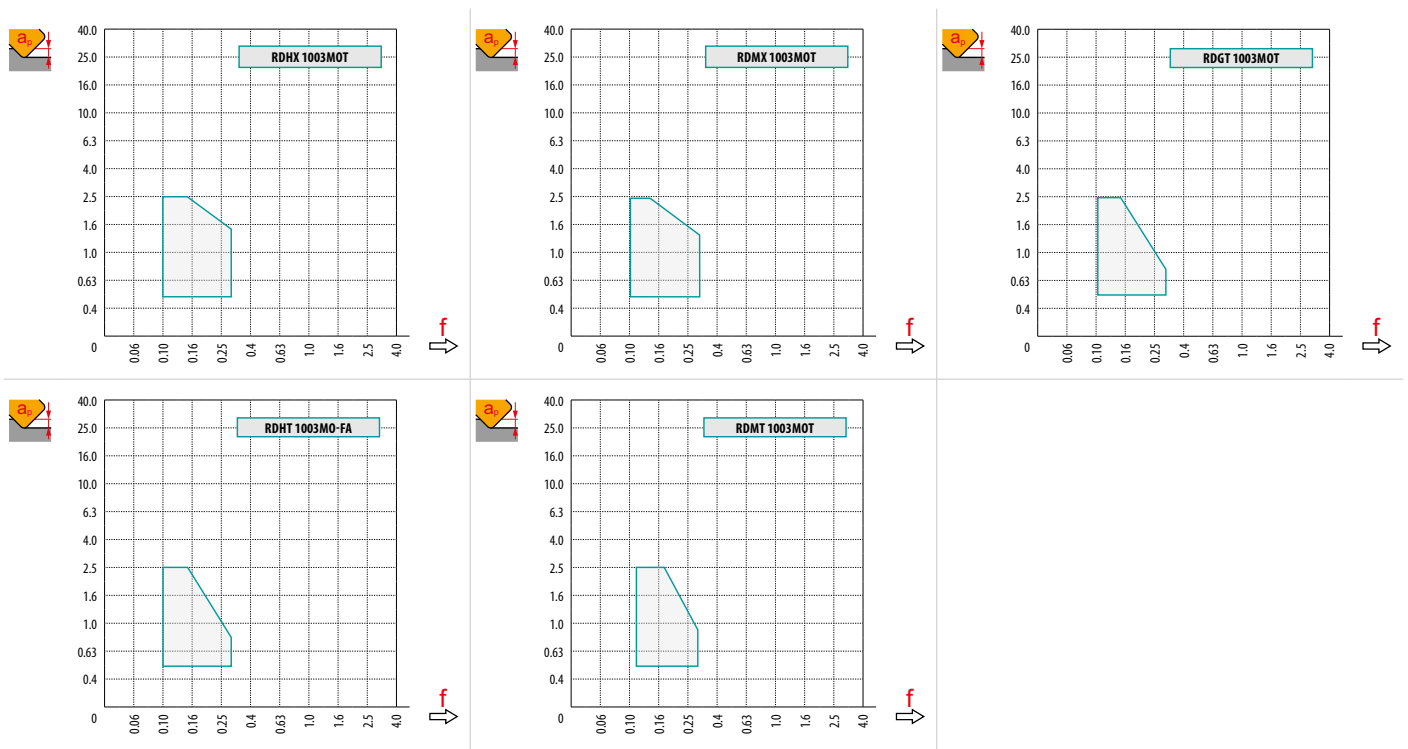

		0.00	0.50	0.75	1.00	1.25	1.50	2.00	2.50	3.00	3.50	4.00	5.00
20		10.0	14.4	15.3	16.0	16.6	17.1	18.0	18.7	19.2	19.5	19.8	20.0
25		15.0	19.4	20.3	21.0	21.6	22.1	23.0	23.7	24.2	24.5	24.8	25.0
30		20.0	24.4	25.3	26.0	26.6	27.1	28.0	28.7	29.2	29.5	29.8	30.0
32		22.0	26.4	27.3	28.0	28.6	29.1	30.0	30.7	31.2	31.5	31.8	32.0
35		25.0	29.4	30.3	31.0	31.6	32.1	33.0	33.7	34.2	34.5	34.8	35.0
42		32.0	36.4	37.3	38.0	38.6	39.1	40.0	40.7	41.2	41.5	41.8	42.0
52		42.0	46.4	47.3	48.0	48.6	49.1	50.0	50.7	51.2	51.5	51.8	52.0
		0.00	0.50	0.75	1.00	1.25	1.50	2.00	2.50	3.00	3.50	4.00	5.00
		-	0.54	0.44	0.39	0.35	0.32	0.28	0.25	0.23	0.22	0.21	0.19

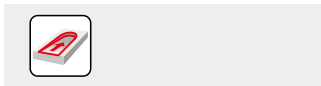

20	20	2.5/15
25	12	2.5/25
30	8	2.5/37
32	7.5	2.5/20
35	7	2.5/42
42	4	2.5/37
52	3	2.5/49

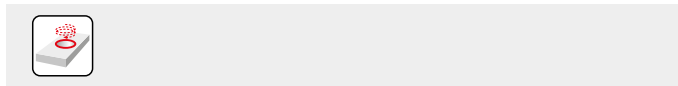

	DMIN	DMAX		
20	22.0	40.0	2.5	2.5
25	32.0	50.0	2.5	2.5
30	42.0	60.0	2.5	2.5
32	46.0	64.0	2.5	2.5
35	52.0	70.0	2.5	2.5
42	66.0	84.0	2.5	2.5
52	86.0	104.0	2.5	2.5

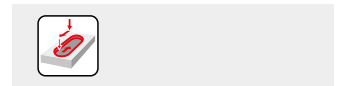

	2.5
--	-----

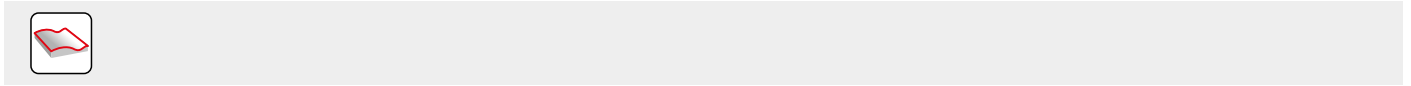

		3	5	10	15	20	30	40	50	60	80	100
20		0.490	0.632	0.894	1.095	1.265	1.549	1.789	2.000	2.191	2.530	2.828
25		0.548	0.707	1.000	1.225	1.414	1.732	2.000	2.236	2.449	2.828	3.162
30		0.600	0.775	1.095	1.342	1.549	1.897	2.191	2.449	2.683	3.098	3.464
32		0.620	0.800	1.131	1.386	1.600	1.960	2.263	2.530	2.771	3.200	3.578
35		0.648	0.837	1.183	1.449	1.673	2.049	2.366	2.646	2.898	3.347	3.742
42		0.710	0.917	1.296	1.587	1.833	2.245	2.592	2.898	3.175	3.666	4.099
52		0.790	1.020	1.442	1.766	2.040	2.498	2.884	3.225	3.533	4.079	4.561
		3	5	10	15	20	30	40	50	60	80	100
5.0		0.346	0.447	0.632	0.775	0.894	1.095	1.265	1.414	1.549	1.789	2.000



SRD12

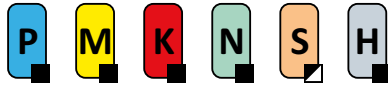

PRAMET

S(C)



Copy Milling Cutter for Round Inserts RD.. 12 with Internal Coolant

Milling cutter for copy milling utilising positive RD.. 12 inserts with APMX of 3 mm. Internal coolant. Suitable for face, helical interpolation, ramping, progressive plunge and copy milling. Available in modular and arbor style, in range Ø24 up to Ø80 mm. Body treated for longer tool life.

APMX	3.0 mm
------	--------

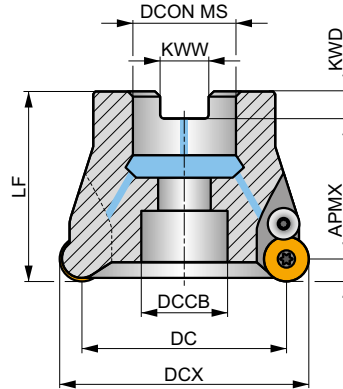
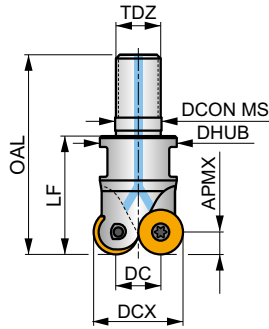
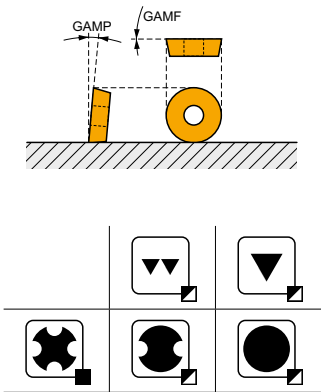

Product	DCX	DC	OAL	DCON MS	DHUB	DCCB	LF	TDZ	KWW	KWD	GAMF	GAMP	Rotation			kg	G120	C0362	
	[mm]	[mm]	[mm]	[mm]	[mm]	[mm]	[mm]	[mm]	[mm]	[mm]	[°]	[°]	max.	max.					
24E2R032M12-SRD12-CF	24	12	54	12.5	21	-	32	M12	-	-	-3	0	2	-	21900	✓	0.07	G120	C0362
35E3R042M16-SCRD12-CF	35	23	65	17	29	-	42	M16	-	-	0	0	3	-	18100	✓	0.19	G120	C0364
35E4R042M16-SRD12-CF	35	23	65	17	29	-	42	M16	-	-	0	0	4	-	18100	✓	0.20	G120	C0362
42E4R042M16-SCRD12-CF	42	30	65	17	29	-	42	M16	-	-	0	0	4	-	16600	✓	0.21	G120	C0364
42E5R042M16-SRD12-CF	42	30	65	17	29	-	42	M16	-	-	0	0	5	-	16600	✓	0.22	G120	C0366
50A05R-SCMORD12-CF	50	38	-	22	-	18	50	-	10.4	10.4	2	7	5	-	15200	✓	0.29	G120	C0366
52A05R-SCMORD12-CF	52	40	-	22	-	18	50	-	10.4	10.4	2	7	5	-	14900	✓	0.32	G120	C0366
66A06R-SCMORD12-CF	66	54	-	27	-	22	50	-	12.4	12.4	2	7	6	-	13200	✓	0.54	G120	C0370
80A07R-SCMORD12-CF	80	68	-	27	-	38	52	-	12.4	12.4	2	7	7	-	12000	✓	0.89	G120	C0372

G120	RD.. 12T3MOT	RDHT 12T3M0-FA

Product	US	Nm	M	mm	mm	mm	mm	mm	mm	mm
C0362	US 3508-T15P	3.5	M 3.5	8	-	-	Flag T15P	-	-	-
C0364	US 3006-T09P	2.0	M 3	6	D-T07P/T09P	FG-15	HS 1230C	-	-	-
C0366	US 3508-T15P	3.5	M 3.5	8	D-T08P/T15P	FG-15	-	CS12P	HS 1030C	-
C0370	US 3508-T15P	3.5	M 3.5	8	D-T08P/T15P	FG-15	-	CS12P	HS 1230C	-
C0372	US 3508-T15P	3.5	M 3.5	8	D-T08P/T15P	FG-15	-	CS12P	-	-



RDHX 12

	INSD	D1	S
	[mm]	[mm]	[mm]
12T3	12.0	3.90	3.97

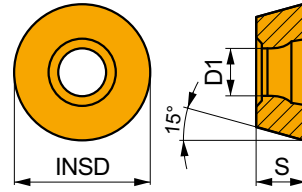

Suitability and starting values for cutting speed (vc), feed (f) and depth of cut (ap). Refer to our Machining Calculator app for further calculations.

Product	RE	P			M			K			N			S			H		
		vc	f	ap	vc	f	ap	vc	f	ap	vc	f	ap	vc	f	ap	vc	f	ap
	[mm]	[m/min]	[mm/tooth]	[mm]	[m/min]	[mm/tooth]	[mm]	[m/min]	[mm/tooth]	[mm]	[m/min]	[mm/tooth]	[mm]	[m/min]	[mm/tooth]	[mm]	[m/min]	[mm/tooth]	[mm]

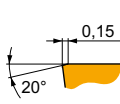

Zero rake angle design for finish machining.

RDHX 12T3MOT	M4303	–	☑	300	0.20	1.5	–	–	–	■	285	0.20	1.5	–	–	–	–	–	–	■	60	0.15	1.0
	M8310	–	☑	300	0.20	1.5	–	–	–	■	285	0.20	1.5	–	–	–	–	–	–	■	60	0.15	1.0
	M8325	–	☑	225	0.20	1.5	–	–	–	–	–	–	–	–	–	–	–	–	–	–	–	–	–
	M8330	–	☑	270	0.20	1.5	–	–	–	■	255	0.20	1.5	–	–	–	–	–	–	☑	50	0.15	1.0
	M8345	–	☑	200	0.20	1.5	–	–	–	–	–	–	–	–	–	–	–	–	–	–	–	–	–

RDMX 12

	INSD	D1	S
	[mm]	[mm]	[mm]
12T3	12.0	3.90	3.97

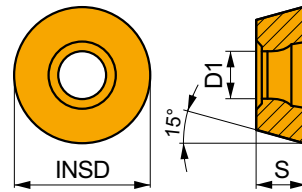

Suitability and starting values for cutting speed (vc), feed (f) and depth of cut (ap). Refer to our Machining Calculator app for further calculations.

Product	RE	P			M			K			N			S			H		
		vc	f	ap	vc	f	ap	vc	f	ap	vc	f	ap	vc	f	ap	vc	f	ap
	[mm]	[m/min]	[mm/tooth]	[mm]	[m/min]	[mm/tooth]	[mm]	[m/min]	[mm/tooth]	[mm]	[m/min]	[mm/tooth]	[mm]	[m/min]	[mm/tooth]	[mm]	[m/min]	[mm/tooth]	[mm]

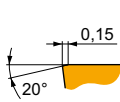
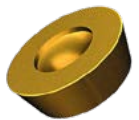

Zero rake angle design for finish machining.

RDMX 12T3MOT	M8310	–	☑	300	0.20	1.5	–	–	–	■	285	0.20	1.5	–	–	–	–	–	–	■	60	0.15	1.0
	M8325	–	☑	225	0.20	1.5	–	–	–	–	–	–	–	–	–	–	–	–	–	–	–	–	
	M8345	–	☑	200	0.20	1.5	–	–	–	–	–	–	–	–	–	–	–	–	–	–	–	–	



RDGT 12

PRAMET

	INSD	D1	S
	[mm]	[mm]	[mm]
12T3	12.0	3.90	3.97

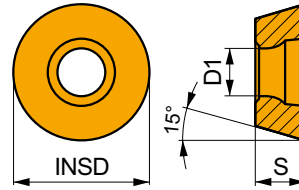

Suitability and starting values for cutting speed (vc), feed (f) and depth of cut (ap). Refer to our Machining Calculator app for further calculations.

Product	RE	P			M			K			N			S			H		
		vc	f	ap	vc	f	ap	vc	f	ap	vc	f	ap	vc	f	ap	vc	f	ap
	[mm]	[m/min]	[mm/tooth]	[mm]	[m/min]	[mm/tooth]	[mm]	[m/min]	[mm/tooth]	[mm]	[m/min]	[mm/tooth]	[mm]	[m/min]	[mm/tooth]	[mm]	[m/min]	[mm/tooth]	[mm]

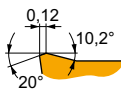

Positive design for finish machining.

RDGT 12T3MOT	M6330	-	260	0.20	1.5	185	0.18	1.5	-	-	-	-	-	-	75	0.14	1.2	-	-	-
	M8310	-	330	0.20	1.5	165	0.18	1.5	310	0.20	1.5	-	-	-	-	-	-	-	-	-
	M8325	-	250	0.20	1.5	120	0.18	1.5	-	-	-	-	-	-	-	-	-	-	-	-
	M8345	-	225	0.20	1.5	135	0.18	1.5	-	-	-	-	-	-	55	0.14	1.2	-	-	-
	M9340	-	340	0.20	1.5	200	0.18	1.5	-	-	-	-	-	-	85	0.14	1.2	-	-	-

RDHT 12-FA

PRAMET

	INSD	D1	S
	[mm]	[mm]	[mm]
12T3	12.0	3.90	3.97

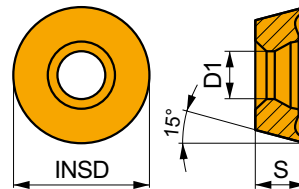

Suitability and starting values for cutting speed (vc), feed (f) and depth of cut (ap). Refer to our Machining Calculator app for further calculations.

Product	RE	P			M			K			N			S			H		
		vc	f	ap	vc	f	ap	vc	f	ap	vc	f	ap	vc	f	ap	vc	f	ap
	[mm]	[m/min]	[mm/tooth]	[mm]	[m/min]	[mm/tooth]	[mm]	[m/min]	[mm/tooth]	[mm]	[m/min]	[mm/tooth]	[mm]	[m/min]	[mm/tooth]	[mm]	[m/min]	[mm/tooth]	[mm]

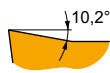

FA geometry with highly positive design for fine-finish to medium machining.

RDHT 12T3M0-FA	HF7	-	-	-	-	-	-	-	360	0.24	1.5	-	-	-	-	-	-	-	-
----------------	-----	---	---	---	---	---	---	---	-----	------	-----	---	---	---	---	---	---	---	---



RDMT 12

	INSD	D1	S
	[mm]	[mm]	[mm]
12T3	12.0	3.90	3.97

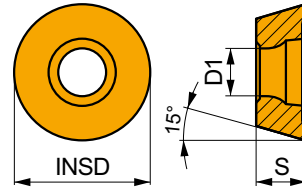

Suitability and starting values for cutting speed (vc), feed (f) and depth of cut (ap). Refer to our Machining Calculator app for further calculations.

Product	RE [mm]	P			M			K			N			S			H		
		vc [m/min]	f [mm/tooth]	ap [mm]	vc [m/min]	f [mm/tooth]	ap [mm]	vc [m/min]	f [mm/tooth]	ap [mm]	vc [m/min]	f [mm/tooth]	ap [mm]	vc [m/min]	f [mm/tooth]	ap [mm]	vc [m/min]	f [mm/tooth]	ap [mm]

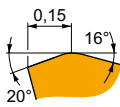

Positive design for finish machining.

RDMT 12T3MOT	M8325	—	■	250	0.20	1.5	▣	120	0.18	1.5	■	—	—	—	■	—	—	—	■	—	—	—
	M8345	—	■	225	0.20	1.5	▣	135	0.18	1.5	■	—	—	—	■	—	—	—	■	—	—	—



a_e / DCX	5 %	10 %	15 %	20 %	25 %	30 %	40 %	50 %	60 %	70 %	75 %	80 %	90 %	100 %
	1.48	1.35	1.27	1.22	1.19	1.16	1.11	1.08	1.05	1.03	1.00	1.00	1.00	1.00
	2.20	1.60	1.35	1.20	1.10	0.95	0.85	0.75	0.85	0.95	1.00	1.00	1.00	1.00
	0.64	0.64	0.64	0.64	0.64	0.65	0.65	0.67	0.68	0.71	0.72	0.74	0.79	1.00

	RDHX 12	RDMX 12	RDGT 12	RDHT 12-FA
	6.0	6.0	6.0	6.0
	-	-	-	-

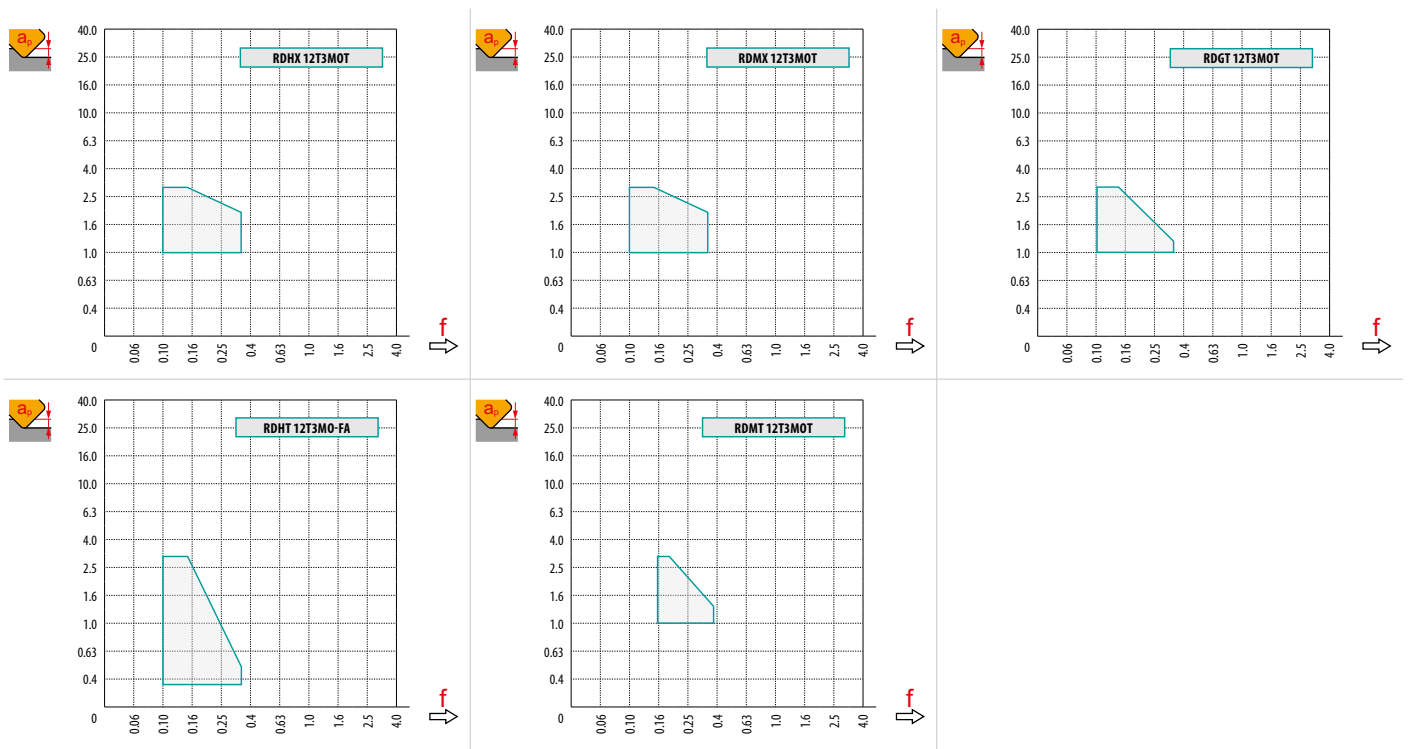

		0.00	0.50	0.75	1.00	1.25	1.50	2.00	2.50	3.00	3.50	4.00	5.00	6.00
24		12.0	16.8	17.8	18.6	19.3	19.9	20.9	21.7	22.4	22.9	23.3	23.8	24.0
35		23.0	27.8	28.8	29.6	30.3	30.9	31.9	32.7	33.4	33.9	34.3	34.8	35.0
42		30.0	34.8	35.8	36.6	37.3	37.9	38.9	39.7	40.4	40.9	41.3	41.8	42.0
50		38.0	42.8	43.8	44.6	45.3	45.9	46.9	47.7	48.4	48.9	49.3	49.8	50.0
52		40.0	44.8	45.8	46.6	47.3	47.9	48.9	49.7	50.4	50.9	51.3	51.8	52.0
66		54.0	58.8	59.8	60.6	61.3	61.9	62.9	63.7	64.4	64.9	65.3	65.8	66.0
80	68.0	72.8	73.8	74.6	75.3	75.9	76.9	77.7	78.4	78.9	79.3	79.8	80.0	
		0.00	0.50	0.75	1.00	1.25	1.50	2.00	2.50	3.00	3.50	4.00	5.00	6.00
		-	0.49	0.40	0.35	0.32	0.29	0.25	0.23	0.21	0.20	0.18	0.17	0.16

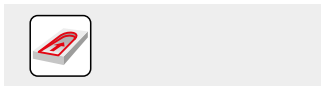

24	25.0	3.0/14
35	9.0	3.0/39
42	8.0	3.0/44
50	4.0	3.0/87
52	4.0	3.0/87
66	3.0	3.0/100
80	2.2	3.0/100

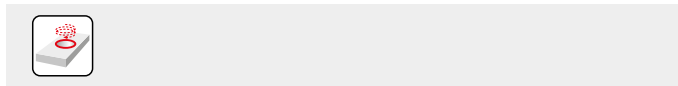

	DMIN	DMAX		
24	26.0	48.0	3.0	3.0
35	46.0	70.0	3.0	3.0
42	62.0	84.0	3.0	3.0
50	78.0	100.0	2.8	2.8
52	82.0	104.0	2.8	2.8
66	110.0	132.0	2.8	2.8
80	136.0	160.0	2.8	2.8

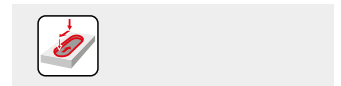

	2.8
--	-----

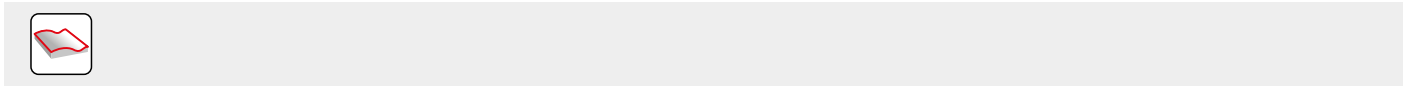

		3	5	10	15	20	30	40	50	60	80	100
24		0.537	0.693	0.980	1.200	1.386	1.697	1.960	2.191	2.400	2.771	3.098
35		0.648	0.837	1.183	1.449	1.673	2.049	2.366	2.646	2.898	3.347	3.742
42		0.710	0.917	1.296	1.587	1.833	2.245	2.592	2.898	3.175	3.666	4.099
50		0.775	1.000	1.414	1.732	2.000	2.449	2.828	3.162	3.464	4.000	4.472
52		0.790	1.020	1.442	1.766	2.040	2.498	2.884	3.225	3.533	4.079	4.561
66		0.890	1.149	1.625	1.990	2.298	2.814	3.250	3.633	3.980	4.596	5.138
80		0.980	1.265	1.789	2.191	2.530	3.098	3.578	4.000	4.382	5.060	5.657
		3	5	10	15	20	30	40	50	60	80	100
6.0		0.379	0.490	0.693	0.849	0.980	1.200	1.386	1.549	1.697	1.960	2.191



SRD16

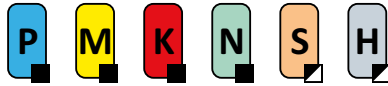

PRAMET

S(C)



Copy Milling Cutter for Round Inserts RD.. 16 with Internal Coolant

Milling cutter for copy milling utilising positive RD.. 16 inserts with APMX of 4 mm. Internal coolant. Suitable for face, helical interpolation, ramping, progressive plunge and copy milling. Available in modular and arbor style, in range Ø32 up to Ø100 mm. Body treated for longer tool life.

APMX	4.0 mm
------	--------

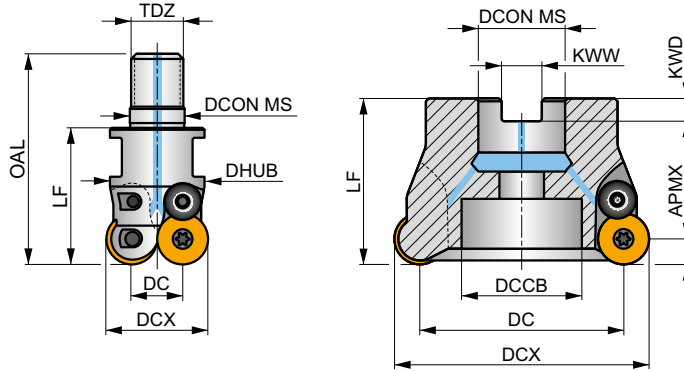
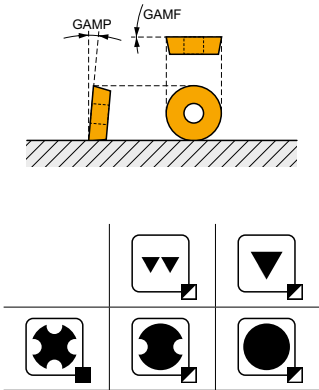

Product	DCX	DC	OAL	DCON MS	DHUB	DCCB	LF	TDZ	KWW	KWD	GAMF	GAMP	max.	kg	Icons
	[mm]	[mm]	[mm]	[mm]	[mm]	[mm]	[mm]	[mm]	[mm]	[mm]	[°]	[°]			
32E2R042M16-SCRD16-CF	32	16	65	17	29	-	42	M16	-	-	-2	0	2	-	12600 ✓ 0.16 GI121 C0374
52A04R-SCMORD16-CF	52	36	-	22	-	16.5	50	-	10.4	10.4	0	7	4	-	9900 ✓ 0.28 GI121 C0376
66A05R-SCMORD16-CF	66	50	-	27	-	22	50	-	12.4	12.4	0	7	5	-	8800 ✓ 0.61 GI121 C0378
80A06R-SCMORD16-CF	80	64	-	27	-	38	52	-	12.4	12.4	0	7	6	-	8000 ✓ 0.75 GI121 C0380
100A07R-SCMORD16-CF	100	84	-	32	-	45	52	-	14.4	14.4	0	7	7	-	7100 ✓ 1.41 GI121 C0380

GI121	RD.. 1604MOT	RDHT 1604MO-FA

Product	US	Nm	M	mm	mm	mm	mm
C0374	US 64510-T20P	4.5	M 4.5	10	-	Flag T20P	CS16P
C0376	US 64510-T20P	4.5	M 4.5	10	SDR T20P-T	-	CS16P
C0378	US 64510-T20P	4.5	M 4.5	10	SDR T20P-T	-	CS16P
C0380	US 64510-T20P	4.5	M 4.5	10	SDR T20P-T	-	CS16P



RDHX 16

	INSD	D1	S
	[mm]	[mm]	[mm]
1604	16.0	5.20	4.76

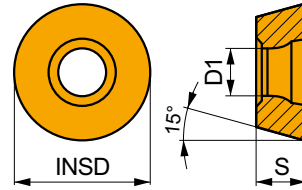

Suitability and starting values for cutting speed (vc), feed (f) and depth of cut (ap). Refer to our Machining Calculator app for further calculations.

Product	RE [mm]	P			M			K			N			S			H		
		vc [m/min]	f [mm/tooth]	ap [mm]	vc [m/min]	f [mm/tooth]	ap [mm]	vc [m/min]	f [mm/tooth]	ap [mm]	vc [m/min]	f [mm/tooth]	ap [mm]	vc [m/min]	f [mm/tooth]	ap [mm]			

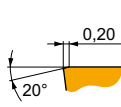

Zero rake angle design for finish machining.

RDHX 1604MOT	M8310	–	☑	255	0.30	2.0	–	–	–	■	240	0.30	2.0	–	–	–	–	–	–	■	50	0.15	1.0	
	M8325	–	☑	195	0.30	2.0	–	–	–	–	–	–	–	–	–	–	–	–	–	–	–	–	–	
	M8330	–	☑	245	0.30	2.0	–	–	–	■	230	0.30	2.0	–	–	–	–	–	–	–	☑	45	0.15	1.0
	M8345	–	☑	180	0.30	2.0	–	–	–	–	–	–	–	–	–	–	–	–	–	–	–	–	–	–
	M9325	–	☑	290	0.30	2.0	–	–	–	■	275	0.30	2.0	–	–	–	–	–	–	–	–	☑	55	0.15

RDMX 16

	INSD	D1	S
	[mm]	[mm]	[mm]
1604	16.0	5.20	4.76

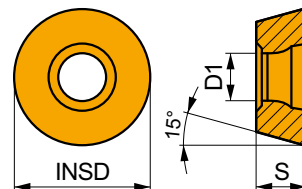

Suitability and starting values for cutting speed (vc), feed (f) and depth of cut (ap). Refer to our Machining Calculator app for further calculations.

Product	RE [mm]	P			M			K			N			S			H		
		vc [m/min]	f [mm/tooth]	ap [mm]	vc [m/min]	f [mm/tooth]	ap [mm]	vc [m/min]	f [mm/tooth]	ap [mm]	vc [m/min]	f [mm/tooth]	ap [mm]	vc [m/min]	f [mm/tooth]	ap [mm]			

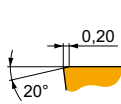
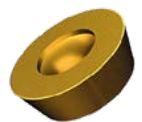

Zero rake angle design for finish machining.

RDMX 1604MOT	M8310	–	☑	255	0.30	2.0	–	–	–	■	240	0.30	2.0	–	–	–	–	–	–	■	50	0.15	1.0
	M8325	–	☑	195	0.30	2.0	–	–	–	–	–	–	–	–	–	–	–	–	–	–	–	–	–
	M8345	–	☑	180	0.30	2.0	–	–	–	–	–	–	–	–	–	–	–	–	–	–	–	–	–



RDGT 16

PRAMET

	INSD	D1	S
	[mm]	[mm]	[mm]
1604	16.0	5.20	4.76

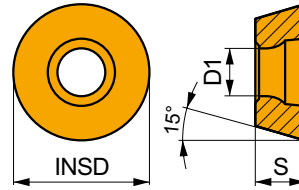

Suitability and starting values for cutting speed (vc), feed (f) and depth of cut (ap). Refer to our Machining Calculator app for further calculations.

Product	RE	P			M			K			N			S			H		
		vc	f	ap	vc	f	ap	vc	f	ap	vc	f	ap	vc	f	ap	vc	f	ap
	[mm]	[m/min]	[mm/tooth]	[mm]	[m/min]	[mm/tooth]	[mm]	[m/min]	[mm/tooth]	[mm]	[m/min]	[mm/tooth]	[mm]	[m/min]	[mm/tooth]	[mm]	[m/min]	[mm/tooth]	[mm]

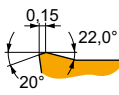

Positive design for finish machining.

RDGT 1604MOT	M6330	–	■	230	0.30	2.0	■	165	0.27	2.0	–	–	–	–	–	–	■	65	0.21	1.6	–	–	–	
	M8310	–	■	285	0.30	2.0	■	145	0.27	2.0	■	270	0.30	2.0	–	–	–	–	–	–	–	–	–	–
	M8325	–	■	220	0.30	2.0	■	105	0.27	2.0	–	–	–	–	–	–	–	–	–	–	–	–	–	–
	M8345	–	■	200	0.30	2.0	■	120	0.27	2.0	–	–	–	–	–	–	■	50	0.21	1.6	–	–	–	–
	M9340	–	■	290	0.30	2.0	■	170	0.27	2.0	–	–	–	–	–	–	■	70	0.21	1.6	–	–	–	–

RDHT 16-FA

PRAMET

	INSD	D1	S
	[mm]	[mm]	[mm]
1604	16.0	5.20	4.76

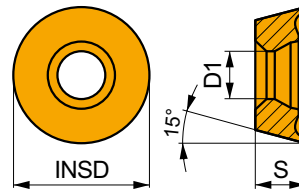

Suitability and starting values for cutting speed (vc), feed (f) and depth of cut (ap). Refer to our Machining Calculator app for further calculations.

Product	RE	P			M			K			N			S			H		
		vc	f	ap	vc	f	ap	vc	f	ap	vc	f	ap	vc	f	ap	vc	f	ap
	[mm]	[m/min]	[mm/tooth]	[mm]	[m/min]	[mm/tooth]	[mm]	[m/min]	[mm/tooth]	[mm]	[m/min]	[mm/tooth]	[mm]	[m/min]	[mm/tooth]	[mm]	[m/min]	[mm/tooth]	[mm]

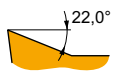

FA geometry with highly positive design for fine-finish to medium machining.

RDHT 1604MO-FA	HF7	–	–	–	–	–	–	–	–	–	■	315	0.36	2.0	–	–	–	–	–	–	–	–	–	–
-----------------------	------------	---	---	---	---	---	---	---	---	---	---	-----	------	-----	---	---	---	---	---	---	---	---	---	---



RDMT 16

	INSD	D1	S
	[mm]	[mm]	[mm]
1604	16.0	5.20	4.76

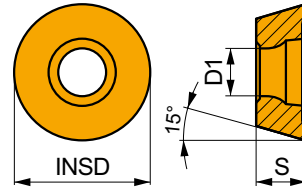

Suitability and starting values for cutting speed (vc), feed (f) and depth of cut (ap). Refer to our Machining Calculator app for further calculations.

Product	RE [mm]	P			M			K			N			S			H		
		vc [m/min]	f [mm/tooth]	ap [mm]	vc [m/min]	f [mm/tooth]	ap [mm]	vc [m/min]	f [mm/tooth]	ap [mm]	vc [m/min]	f [mm/tooth]	ap [mm]	vc [m/min]	f [mm/tooth]	ap [mm]	vc [m/min]	f [mm/tooth]	ap [mm]

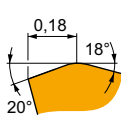

Positive design for finish machining.

RDMT 1604MOT	M8325	—	■	220	0.30	2.0	▣	105	0.27	2.0	■	—	—	—	■	—	—	—	■	—	—	—
	M8345	—	■	200	0.30	2.0	▣	120	0.27	2.0	■	—	—	—	■	—	—	—	■	—	—	—



a_e DCX	5%	10%	15%	20%	25%	30%	40%	50%	60%	70%	75%	80%	90%	100%
	1.48	1.35	1.27	1.22	1.19	1.16	1.11	1.08	1.05	1.03	1.00	1.00	1.00	1.00
	2.20	1.60	1.35	1.20	1.10	0.95	0.85	0.75	0.85	0.95	1.00	1.00	1.00	1.00
	0.64	0.64	0.64	0.64	0.64	0.65	0.65	0.67	0.68	0.71	0.72	0.74	0.79	1.00

	RDHX 16	RDMX 16	RDGT 16	RDHT 16-FA
	8.0	8.0	8.0	8.0
	-	-	-	-

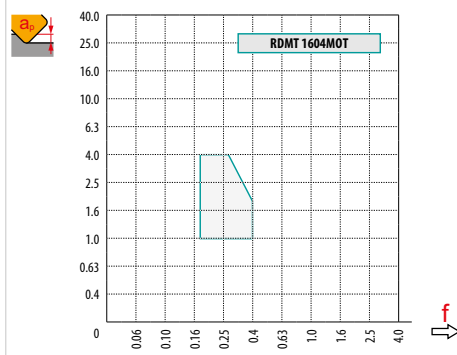
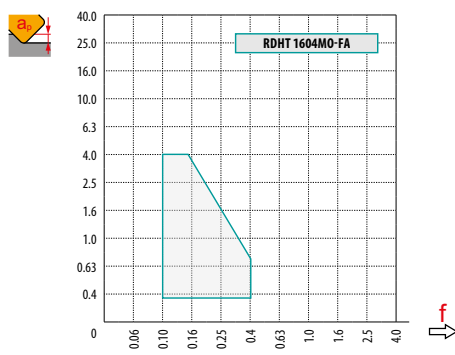
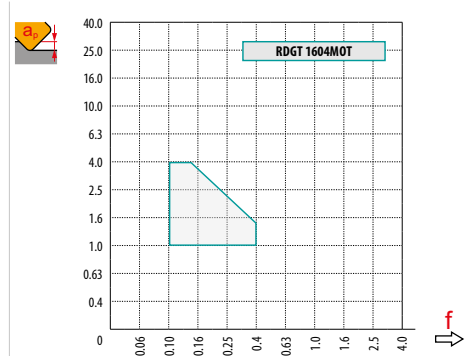
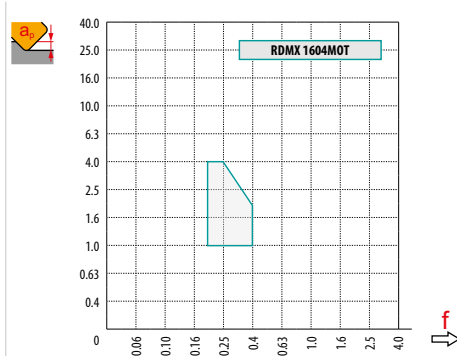
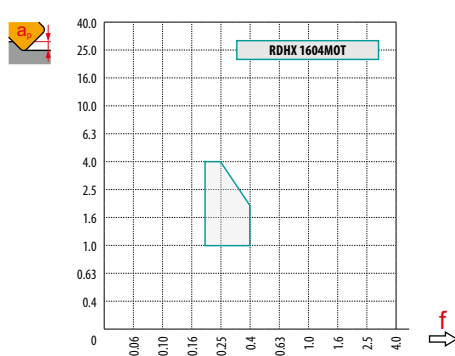

		0.00	0.50	0.75	1.00	1.25	1.50	2.00	2.50	3.00	3.50	4.00	5.00	6.00	7.00	8.00
32		16.0	21.6	22.8	23.7	24.6	25.3	26.6	27.6	28.5	29.2	29.9	30.8	31.5	31.9	32.0
52		36.0	41.6	42.8	43.7	44.6	45.3	46.6	47.6	48.5	49.2	49.9	50.8	51.5	51.9	52.0
66		50.0	55.6	56.8	57.7	58.6	59.3	60.6	61.6	62.5	63.2	63.9	64.8	65.5	65.9	66.0
80		64.0	69.6	70.8	71.7	72.6	73.3	74.6	75.6	76.5	77.2	77.9	78.8	79.5	79.9	80.0
100		84.0	89.6	90.8	91.7	92.6	93.3	94.6	95.6	96.5	97.2	97.9	98.8	99.5	99.9	100.0
		0.00	0.50	0.75	1.00	1.25	1.50	2.00	2.50	3.00	3.50	4.00	5.00	6.00	7.00	8.00
		-	0.91	0.74	0.65	0.58	0.53	0.46	0.42	0.38	0.36	0.34	0.30	0.28	0.26	0.25

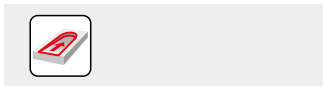

32	25.0	4.0/19
52	8.0	4.0/58
66	6.0	4.0/78
80	4.0	4.0/100
100	3.0	4.0/100

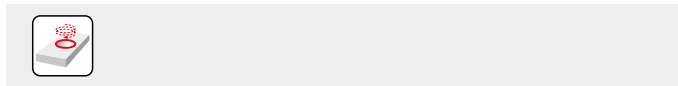

	DMIN	DMAX		
32	34.0	64.0	4.0	4.0
52	74.0	104.0	4.0	4.0
66	102.0	132.0	4.0	4.0
80	130.0	160.0	4.0	4.0
100	170.0	200.0	4.0	4.0

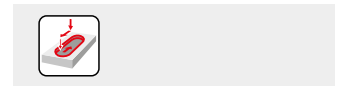

	4.0
--	-----

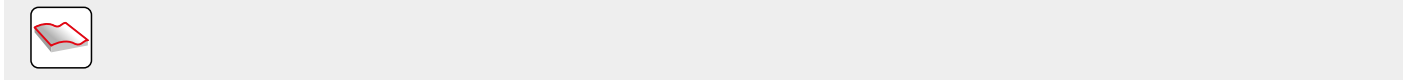

		3	5	10	15	20	30	40	50	60	80	100
32		0.620	0.800	1.131	1.386	1.600	1.960	2.263	2.530	2.771	3.200	3.578
52		0.790	1.020	1.442	1.766	2.040	2.498	2.884	3.225	3.533	4.079	4.561
66		0.890	1.149	1.625	1.990	2.298	2.814	3.250	3.633	3.980	4.596	5.138
80		0.980	1.265	1.789	2.191	2.530	3.098	3.578	4.000	4.382	5.060	5.657
100		1.095	1.414	2.000	2.449	2.828	3.464	4.000	4.472	4.899	5.657	6.325
		3	5	10	15	20	30	40	50	60	80	100
8.0		0.438	0.566	0.800	0.980	1.131	1.386	1.600	1.789	1.960	2.263	2.530



L2-SZP



PRAMET

S



Ball nose Profile Milling Cutter for ZP.. Inserts

Ball nose milling cutter utilising ZP.. style inserts with APMX from 8.9 up to 44.7 mm. Suitable for profile milling. Available in cylindrical, Weldon, Morse taper and modular style, in range Ø10 up to Ø50 mm. Body treated for longer tool life.

APMX	8.9 - 44.7 mm
------	---------------

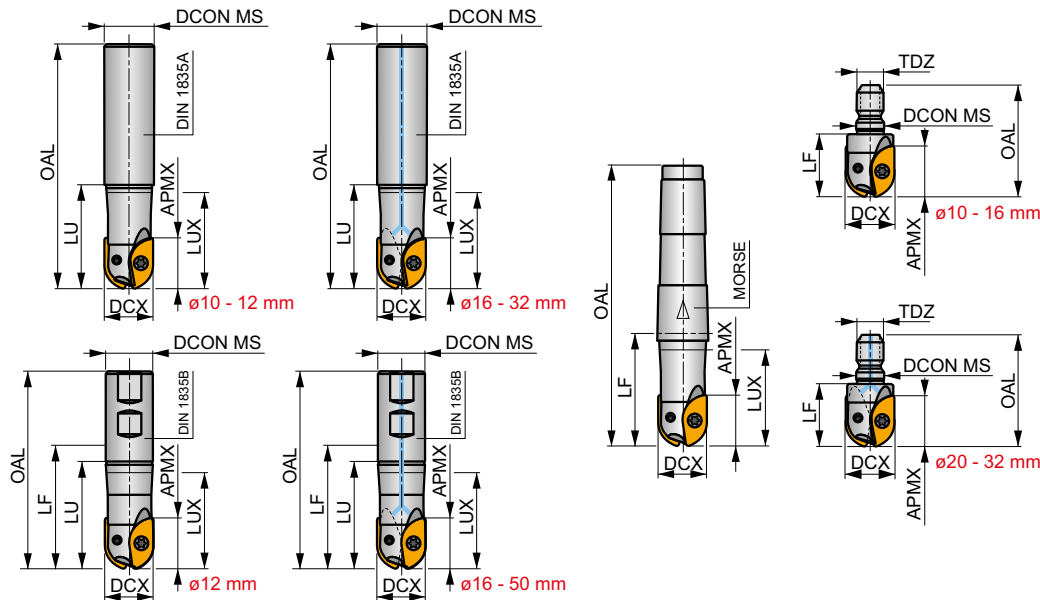
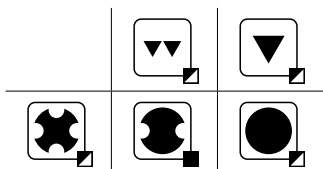
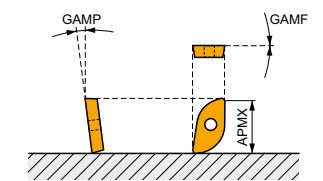

h_m 0.05 - 0.19



Product	DCX	OAL	DCON MS	LU	LUX	LF	TDZ	CZC MS	APMX	GAMF	GAMP							
	[mm]	[mm]	[mm]	[mm]	[mm]	[mm]	[mm]	[mm]	[°]	[°]								
10L2R030A10-SZP10	10	130	10	30	30	-	-	-	-	0	-10	2	-	35800	-	0.11	GI255	C0510
10L2R050A16-SZP10	10	160	16	50	22.3	-	-	-	-	0	-10	2	-	35800	-	0.26	GI255	C0510
12L2R035A12-SZP12	12	140	12	35	35	-	-	-	-	0	-10	2	-	21000	-	0.15	GI253	C0510
12L2R045A20-SZP12	12	200	20	-	22	-	-	-	-	0	-10	2	-	21000	-	0.51	GI253	C0511
16L2R040A16-SZP16-C	16	160	16	40	40	-	-	-	-	0	-10	2	-	20000	✓	0.24	GI256	C0510
16L2R045A20-SZP16-C	16	200	20	-	29.4	-	-	-	-	0	-10	2	-	20000	✓	1.48	GI256	C0512
20L2R050A20-SZP20-C	20	250	20	50	-	-	-	-	-	0	-10	2	-	24000	✓	0.56	GI254	C0513
20L2R055A25-SZP20-C	20	200	25	-	36.1	-	-	-	-	0	-10	2	-	24000	✓	0.68	GI254	C0513
20L2R055A32-SZP20-C	20	250	32	-	34.5	-	-	-	-	0	-10	2	-	24000	✓	1.34	GI254	C0513
25L2R060A25-SZP25-C	25	250	25	60	-	-	-	-	-	0	-10	2	-	24000	✓	0.86	GI257	C0514
25L2R065A32-SZP25-C	25	250	32	-	43	-	-	-	-	0	-10	2	-	24000	✓	1.34	GI257	C0514
32L2R070A32-SZP32-C	32	250	32	-	-	-	-	-	-	0	-10	2	-	18500	✓	1.43	GI258	C0515
12L2R040B20-SZP12	12	91	20	40	21.5	66.5	-	-	-	0	-10	2	-	21000	-	0.19	GI253	C0511
12L2R060B20-SZP12	12	111	20	60	23.8	86.5	-	-	-	0	-10	2	-	21000	-	0.23	GI253	C0511
16L2R040B20-SZP16-C	16	91	20	40	28.3	66.5	-	-	-	0	-10	2	-	20000	✓	0.15	GI256	C0512
16L2R060B20-SZP16-C	16	111	20	60	32.9	86.5	-	-	-	0	-10	2	-	20000	✓	0.21	GI256	C0512
20L2R050B25-SZP20-C	20	107	25	50	35.1	75.5	-	-	-	0	-10	2	-	24000	✓	0.31	GI254	C0513
20L2R070B25-SZP20-C	20	127	25	70	39.5	95.5	-	-	-	0	-10	2	-	24000	✓	0.36	GI254	C0513
25L2R060B25-SZP25-C	25	117	25	60	-	85.5	-	-	-	0	-10	2	-	24000	✓	0.36	GI257	C0514
25L2R080B25-SZP25-C	25	137	25	80	-	105	-	-	-	0	-10	2	-	24000	✓	0.43	GI257	C0514
32L2R070B32-SZP32-C	32	131	32	70	-	95.5	-	-	-	0	-10	2	-	18500	✓	0.72	GI258	C0515
32L2R100B32-SZP32-C	32	161	32	100	-	125.5	-	-	-	0	-10	2	-	18500	✓	0.85	GI258	C0515
40L2R070B32-SZP40-C	40	131	32	70	-	95.5	-	-	-	0	-10	2	-	8000	✓	0.81	GI259	C0516
40L2R100B40-SZP40-C	40	171	40	100	-	131	-	-	-	0	-10	2	-	8000	✓	1.40	GI259	C0516
50L2R100B50-SZP50-C	50	181	50	100	-	136.5	-	-	-	0	-10	2	-	7000	✓	2.25	GI260	C0517
10L2R050E02-SZP10	10	114	-	-	21.9	50	-	2	-	0	-10	2	-	35800	-	0.13	GI255	C0510
12L2R040E02-SZP12	12	104	-	-	22.5	40	-	2	-	0	-10	2	-	21000	-	0.14	GI253	C0511



Product	DCX	OAL	DCONIMS	LU	LUX	LF	TDZ	CZC MS	APMX	GAMF	GAMP								
	[mm]	[mm]	[mm]	[mm]	[mm]	[mm]			[mm]	[°]	[°]								
	12L2R060E02-SZP12	12	124	-	-	25.8	60	-	2	-	0	-10	2	-	21000	-	0.18	GI253	C0511
	12L2R090E02-SZP12	12	154	-	-	25.8	90	-	2	-	0	-10	2	-	21000	-	0.23	GI253	C0511
	16L2R040E02-SZP16	16	104	-	-	31.3	40	-	2	-	0	-10	2	-	20000	-	0.14	GI256	C0512
	16L2R060E02-SZP16	16	124	-	-	42.2	60	-	2	-	0	-10	2	-	20000	-	0.19	GI256	C0512
	16L2R090E02-SZP16	16	154	-	-	75.9	90	-	2	-	0	-10	2	-	20000	-	0.23	GI256	C0512
	20L2R050E03-SZP20	20	131	-	-	36.6	50	-	3	-	0	-10	2	-	24000	-	0.35	GI254	C0513
	20L2R070E03-SZP20	20	151	-	-	-	70	-	3	-	0	-10	2	-	24000	-	0.39	GI254	C0513
	20L2R100E03-SZP20	20	181	-	-	77.4	100	-	3	-	0	-10	2	-	24000	-	0.42	GI254	C0513
	25L2R080E03-SZP25	25	161	-	-	-	80	-	3	-	0	-10	2	-	24000	-	0.46	GI257	C0514
	25L2R110E04-SZP25	25	213	-	-	92.7	110	-	4	-	0	-10	2	-	24000	-	0.84	GI257	C0514
	32L2R100E04-SZP32	32	203	-	-	-	100	-	4	-	0	-10	2	-	18500	-	0.90	GI258	C0515
	32L2R150E04-SZP32	32	253	-	-	-	150	-	4	-	0	-10	2	-	18500	-	1.10	GI258	C0515
	50L2R100E05-SZP50	50	230	-	-	-	100	-	5	-	0	-10	2	-	7000	-	2.20	GI260	C0517
		10L2R025M08-SZP10	10	-	8.5	-	-	25	M8	-	-	0	-10	2	-	-	-	0.03	GI255
12L2R025M06-SZP12		12	-	6.5	-	-	25	M6	-	-	0	-10	2	-	-	-	0.05	GI253	C0510
12L2R025M08-SZP12		12	-	8.5	-	-	25	M8	-	-	0	-10	2	-	-	-	0.05	GI253	C0511
16L2R025M08-SZP16		16	-	8.5	-	-	25	M8	-	-	0	-10	2	-	-	-	0.05	GI256	C0512
20L2R030M10-SZP20-C		20	-	10.5	-	-	30	M10	-	-	0	-10	2	-	-	✓	0.07	GI254	C0513
25L2R035M12-SZP25-C		25	-	12.5	-	-	35	M12	-	-	0	-10	2	-	-	✓	0.09	GI257	C0514
32L2R045M16-SZP32-C		32	-	17	-	-	45	M16	-	-	0	-10	2	-	-	✓	0.15	GI258	C0515

GI253	ZP 12..
GI254	ZP 20..
GI255	ZP 10..
GI256	ZP 16..
GI257	ZP 25..
GI258	ZP 32..
GI259	ZP 40..
GI260	ZP 50..

C0510	-	-	Flag T06P	US 62004-T06P	0.6	M 2	4	-
C0511	-	-	Flag T08P	US 62506-T08P	1.2	M 2.5	6	-
C0512	-	-	Flag T08P	US 62508-T08P	1.2	M 2.5	7	-
C0513	-	-	Flag T10P	US 63510-T10P	2.0	M 3.5	9	-
C0514	-	-	Flag T15P	US 4011A-T15P	3.5	M 4	11	-
C0515	-	-	-	US 65013-T20	5.0	M 5	13	SDRT20
C0516	-	-	-	US 66015-T25P	7.5	M 6	15	SDR T25P
C0517	SZN 400322	US 3508-T15P	Flag T15P	US 68020-T30P	15.0	M 8	20	SDRT30P



ZP

	W1 [mm]	D1 [mm]	S [mm]
10	10.000	2.20	1.70
12	12.000	2.90	2.38
16	16.000	2.90	3.18
20	20.000	4.00	3.97
25	25.000	4.70	4.76
32	32.000	5.90	6.35
40	40.000	7.00	7.94
50	50.000	9.60	7.94

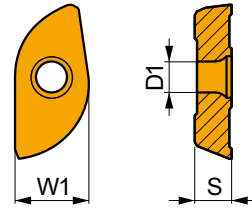

Suitability and starting values for cutting speed (vc), feed (f) and depth of cut (ap). Refer to our Machining Calculator app for further calculations.

Product	RE [mm]	P			M			K			N			S			H		
		vc [m/min]	f [mm/tooth]	ap [mm]	vc [m/min]	f [mm/tooth]	ap [mm]	vc [m/min]	f [mm/tooth]	ap [mm]	vc [m/min]	f [mm/tooth]	ap [mm]	vc [m/min]	f [mm/tooth]	ap [mm]	vc [m/min]	f [mm/tooth]	ap [mm]

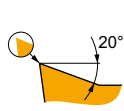

F geometry with highly positive design for light machining.

ZP 20ER-F	M8310	-	305	0.27	1.0	155	0.24	1.0	-	-	-	-	-	-	-	-	-	-
-----------	-------	---	-----	------	-----	-----	------	-----	---	---	---	---	---	---	---	---	---	---



FM geometry with sharp neutral design for light to medium machining.

ZP 10ER-FM	M8310	-	305	0.36	0.5	-	-	-	285	0.36	0.5	-	-	-	-	-	60	0.15	1.0
	M8345	-	210	0.36	0.5	-	-	-	-	-	-	-	-	-	-	-	-	-	
ZP 12ER-FM	M8310	-	300	0.36	0.6	-	-	-	285	0.36	0.6	-	-	-	-	-	60	0.15	1.0
	M8345	-	205	0.36	0.6	-	-	-	-	-	-	-	-	-	-	-	-	-	
ZP 16ER-FM	M8310	-	290	0.36	0.8	-	-	-	275	0.36	0.8	-	-	-	-	-	55	0.15	1.0
	M8345	-	200	0.36	0.8	-	-	-	-	-	-	-	-	-	-	-	-	-	
ZP 20ER-FM	M8310	-	285	0.36	1.0	-	-	-	270	0.36	1.0	-	-	-	-	-	55	0.15	1.0
	M8345	-	195	0.36	1.0	-	-	-	-	-	-	-	-	-	-	-	-	-	
ZP 25ER-FM	M8310	-	275	0.36	1.3	-	-	-	260	0.36	1.3	-	-	-	-	-	55	0.15	1.0
	M8345	-	190	0.36	1.3	-	-	-	-	-	-	-	-	-	-	-	-	-	
ZP 32ER-FM	M8310	-	270	0.36	1.6	-	-	-	255	0.36	1.6	-	-	-	-	-	50	0.15	1.0
	M8345	-	185	0.36	1.6	-	-	-	-	-	-	-	-	-	-	-	-	-	

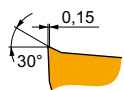

M geometry with very positive design for medium machining.

ZP 12ER-M	M8330	-	280	0.36	0.6	165	0.32	0.6	265	0.36	0.6	-	-	-	70	0.25	0.5	-	-
	M8340	-	260	0.36	0.6	155	0.32	0.6	245	0.36	0.6	-	-	-	65	0.25	0.5	-	-
	M8345	-	205	0.36	0.6	120	0.32	0.6	-	-	-	-	-	50	0.25	0.5	-	-	
ZP 16ER-M	M8330	-	270	0.36	0.8	160	0.32	0.8	255	0.36	0.8	-	-	-	65	0.25	0.6	-	-
	M8340	-	250	0.36	0.8	150	0.32	0.8	235	0.36	0.8	-	-	-	60	0.25	0.6	-	-
	M8345	-	200	0.36	0.8	120	0.32	0.8	-	-	-	-	-	50	0.25	0.6	-	-	
ZP 20ER-M	M8330	-	265	0.36	1.0	155	0.32	1.0	250	0.36	1.0	-	-	-	65	0.25	0.8	-	-
	M8345	-	195	0.36	1.0	115	0.32	1.0	-	-	-	-	-	45	0.25	0.8	-	-	
ZP 25ER-M	M8330	-	260	0.36	1.3	155	0.32	1.3	245	0.36	1.3	-	-	-	65	0.25	1.0	-	-
	M8345	-	190	0.36	1.3	110	0.32	1.3	-	-	-	-	-	45	0.25	1.0	-	-	
ZP 32ER-M	M8330	-	255	0.36	1.6	150	0.32	1.6	240	0.36	1.6	-	-	-	60	0.25	1.3	-	-
	M8345	-	185	0.36	1.6	110	0.32	1.6	-	-	-	-	-	45	0.25	1.3	-	-	

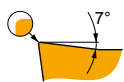

R geometry with sharp slightly positive design for light to medium machining.

ZP 16ER-R	M8345	-	190	0.45	0.8	110	0.41	0.8	-	-	-	-	-	45	0.32	0.6	-	-
ZP 20ER-R	M8345	-	185	0.45	1.0	110	0.41	1.0	-	-	-	-	-	45	0.32	0.8	-	-



Suitability and starting values for cutting speed (vc), feed (f) and depth of cut (ap). Refer to our Machining Calculator app for further calculations.

Product		RE (mm)	P			M			K			N			S			H		
			vc	f	ap	vc	f	ap	vc	f	ap	vc	f	ap	vc	f	ap	vc	f	ap
			[m/min]	[mm/tooth]	[mm]	[m/min]	[mm/tooth]	[mm]	[m/min]	[mm/tooth]	[mm]	[m/min]	[mm/tooth]	[mm]	[m/min]	[mm/tooth]	[mm]	[m/min]	[mm/tooth]	[mm]

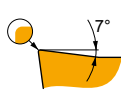

R geometry with sharp slightly positive design for light to medium machining.

ZP 25ER-R	M8345	—	■	180	0.45	1.3	■	105	0.41	1.3	—	—	—	—	—	—	■	45	0.32	1.0	—	—	—		
ZP 32ER-R	M8330	—	■	240	0.45	1.6	■	140	0.41	1.6	▣	225	0.45	1.6	—	—	—	■	60	0.32	1.3	▣	45	0.15	1.0
	M8345	—	■	175	0.45	1.6	■	105	0.41	1.6	—	—	—	—	—	—	■	40	0.32	1.3	—	—	—		
ZP 40ER-R	M8345	—	■	170	0.45	2.0	■	100	0.41	2.0	—	—	—	—	—	—	■	40	0.32	1.6	—	—	—		
ZP 50ER-R	M8345	—	■	165	0.45	2.5	■	95	0.41	2.5	—	—	—	—	—	—	■	40	0.32	2.0	—	—	—		



a_e / DCX	5 %	10 %	15 %	20 %	25 %	30 %	40 %	50 %	60 %	70 %	75 %	80 %	90 %	100 %
	1.48	1.35	1.27	1.22	1.19	1.16	1.11	1.08	1.05	1.03	1.00	1.00	1.00	1.00
	2.20	1.60	1.35	1.20	1.10	0.95	0.85	0.75	0.85	0.95	1.00	1.00	1.00	1.00
	0.64	0.64	0.64	0.64	0.64	0.65	0.65	0.67	0.68	0.71	0.72	0.74	0.79	1.00

	ZP 20-F	ZP 50-F	ZP 10-FM	ZP 12-FM	ZP 16-FM	ZP 20-FM	ZP 25-FM	ZP 32-FM
	10.0	25.0	5.0	6.0	8.0	10.0	12.5	16.0
	-	-	-	-	-	-	-	-

	ZP 12-M	ZP 16-M	ZP 20-M	ZP 25-M	ZP 32-M
	6.0	8.0	10.0	12.5	16.0
	-	-	-	-	-

	ZP 16-R	ZP 20-R	ZP 25-R	ZP 32-R	ZP 40-R	ZP 50-R
	8.0	10.0	12.5	16.0	20.0	25.0
	-	-	-	-	-	-

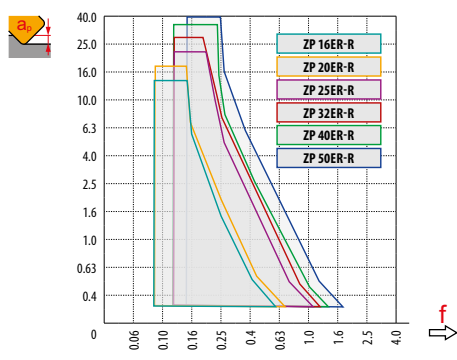
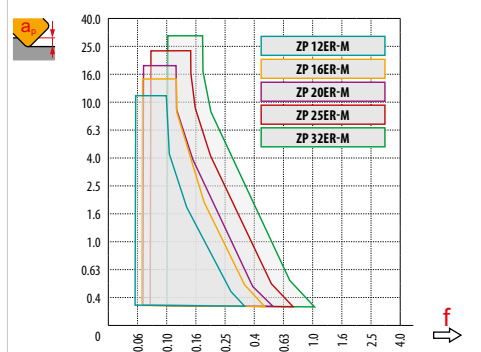
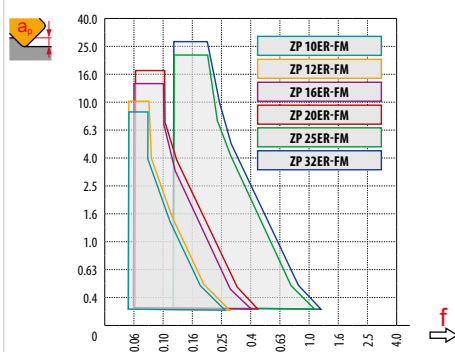
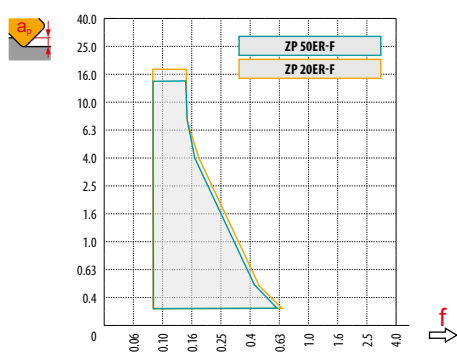



DCX		0.30	0.40	0.50	0.70	1.00	1.25	1.50	2.00	2.50	3.00	4.00	5.00	6.00	8.00	10.00	12.00	15.00	16.00	20.00	22.50	25.00			
10		3.4	3.9	4.4	5.1	6.0	6.6	7.1	8.0	8.7	9.2	9.8	10.0	-	-	-	-	-	-	-	-	-	-		
12		3.7	4.3	4.8	5.6	6.6	7.3	7.9	8.9	9.7	10.4	11.3	11.8	12.0	-	-	-	-	-	-	-	-	-	-	
16		4.3	5.0	5.6	6.5	7.7	8.6	9.3	10.6	11.6	12.5	13.9	14.8	15.5	16.0	-	-	-	-	-	-	-	-	-	-
20		4.9	5.6	6.2	7.4	8.7	9.7	10.5	12.0	13.2	14.3	16.0	17.3	18.3	19.6	20.0	-	-	-	-	-	-	-	-	-
25		5.4	6.3	7.0	8.2	9.8	10.9	11.9	13.6	15.0	16.2	18.3	20.0	21.4	23.3	24.5	25.0	-	-	-	-	-	-	-	-
32		6.2	7.1	7.9	9.4	11.1	12.4	13.5	15.5	17.2	18.7	21.2	23.2	25.0	27.7	29.7	31.2	31.9	32.0	-	-	-	-	-	-
40		6.9	8.0	8.9	10.5	12.5	13.9	15.2	17.4	19.4	21.1	24.0	26.5	28.6	32.0	34.6	37.1	38.7	39.2	40.0	-	-	-	-	-
50		7.7	8.9	9.9	11.7	14.0	15.6	17.1	19.6	21.8	23.7	27.1	30.0	32.5	36.7	40.0	43.3	45.8	46.6	49.0	49.7	50.0	-	-	-

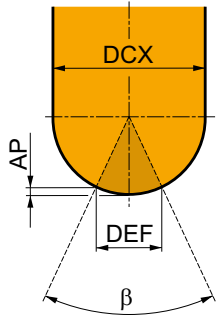

DCX		β	DEF	AP
10	FM	41°	3.496	0.322
12	FM	41°	4.194	0.381
16	FM	42°	5.660	0.520
20	FM	42°	7.100	0.650
25	FM	41°	8.756	0.794
35	FM	41°	11.113	0.998
40	R	41°	14.108	1.298
50	R	45°	19.176	1.915



DCX	μm	3	5	10	15	20	30	40	50	60	80	100
10		0.346	0.447	0.632	0.775	0.894	1.095	1.265	1.414	1.549	1.789	2.000
12		0.379	0.490	0.693	0.849	0.980	1.200	1.386	1.549	1.697	1.960	2.191
16		0.438	0.566	0.800	0.980	1.131	1.386	1.600	1.789	1.960	2.263	2.530
20		0.490	0.632	0.894	1.095	1.265	1.549	1.789	2.000	2.191	2.530	2.828
25		0.548	0.707	1.000	1.225	1.414	1.732	2.000	2.236	2.449	2.828	3.162
32		0.620	0.800	1.131	1.386	1.600	1.960	2.263	2.530	2.771	3.200	3.578
40		0.693	0.894	1.265	1.549	1.789	2.191	2.530	2.828	3.098	3.578	4.000
50		0.775	1.000	1.414	1.732	2.000	2.449	2.828	3.162	3.464	4.000	4.472

DEF	a_e	1%	2.5%	5%	7.5%	10%	15%	20%	25%	30%	35%	40%	45%	50%	60%	70%	75%	80%	90%	100%	
19.9%	1.0%	2.86	1.84	1.33	1.12	1.00	0.89	-	-	-	-	-	-	-	-	-	-	-	-	-	
31.2%	2.5%	3.58	2.28	1.64	1.36	1.20	1.01	0.92	0.88	0.91	-	-	-	-	-	-	-	-	-	-	
43.6%	5.0%	4.22	2.68	1.92	1.58	1.39	1.16	1.03	0.95	0.90	0.88	0.89	-	-	-	-	-	-	-	-	
52.7%	7.5%	4.63	2.95	2.10	1.73	1.51	1.26	1.11	1.02	0.96	0.91	0.89	0.88	0.90	-	-	-	-	-	-	
60.0%	10.0%	4.94	3.14	2.24	1.84	1.61	1.33	1.18	1.07	1.00	0.95	0.91	0.89	0.88	1.00	-	-	-	-	-	
71.4%	15.0%	5.39	3.42	2.43	2.00	1.74	1.44	1.27	1.15	1.07	1.01	0.96	0.93	0.90	0.88	0.93	-	-	-	-	
80.0%	20.0%	5.70	3.62	2.57	2.11	1.84	1.52	1.33	1.21	1.12	1.05	1.00	0.96	0.93	0.89	0.88	0.89	1.00	-	-	
86.6%	25.0%	5.93	3.76	2.67	2.20	1.91	1.58	1.38	1.25	1.16	1.08	1.03	0.99	0.95	0.90	0.88	0.88	0.89	1.00	-	
91.7%	30.0%	6.10	3.87	2.75	2.26	1.96	1.62	1.42	1.28	1.18	1.11	1.05	1.01	0.97	0.92	0.89	0.88	0.88	0.93	-	
95.4%	35.0%	6.23	3.95	2.80	2.30	2.00	1.65	1.44	1.31	1.20	1.13	1.07	1.02	0.98	0.93	0.89	0.88	0.88	0.90	-	
98.0%	40.0%	6.31	4.00	2.84	2.33	2.03	1.67	1.46	1.32	1.22	1.14	1.08	1.03	0.99	0.93	0.90	0.89	0.88	0.89	-	
99.5%	45.0%	6.36	4.03	2.86	2.35	2.04	1.68	1.47	1.33	1.23	1.15	1.09	1.04	1.00	0.94	0.90	0.89	0.88	0.88	-	
100.0%	50.0%	6.38	4.04	2.87	2.35	2.05	1.69	1.48	1.33	1.23	1.15	1.09	1.04	1.00	0.94	0.90	0.89	0.88	0.88	1.00	

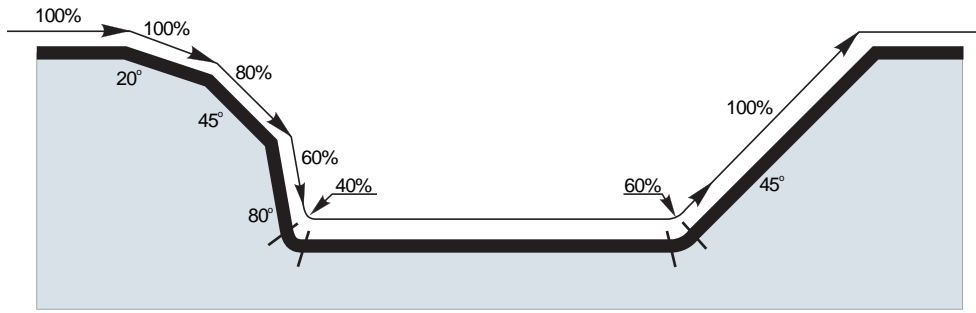

Overhang (multiple of diameter DCX)	<3.0	3.0 – 3.5	3.6 – 4.0	4.1 – 4.5	>4.6
Multiplication factor for speed	1.0	0.9	0.8	0.7	0.5



K3-CXP

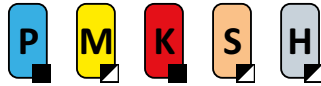

PRAMET

C



MULTISIDE XP Profile Milling Cutter

Ball nose milling cutter utilising XP.. style inserts with APMX from 8 up to 16 mm. Unique clamping enables use of three inserts. Available in cylindrical and modular style, in range Ø16 up to Ø32 mm. Body treated for longer tool life.

MULTISIDE XP

APMX	8.0 - 16.0 mm
------	---------------

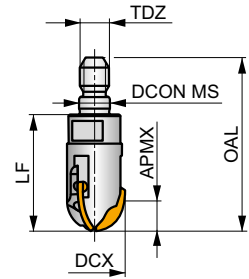
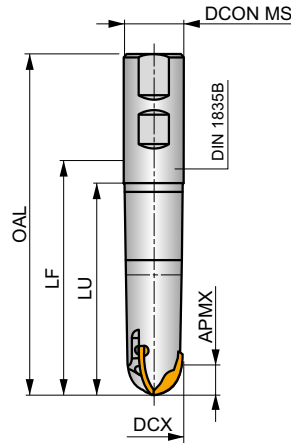
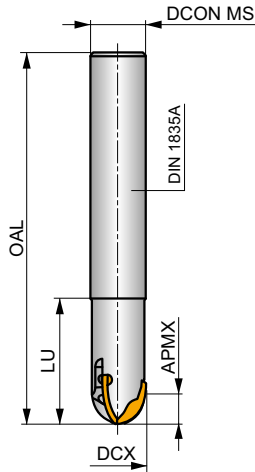
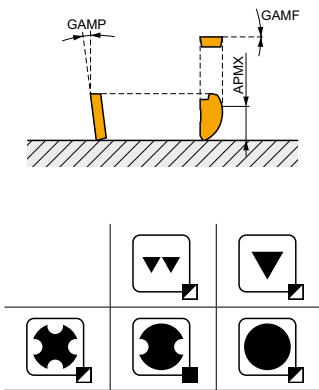

h_m 0.05 - 0.19



Product	DCX	OAL	DCON MS	LU	LUX	LF	TDZ	APMX	GAMF	GAMP							
																	[mm]
	16K3R050A16-CXP16	16	200	16	50	-	-	8.00	0	-5	3	-	22600	-	0.36	GI267	C0520
	16K3R050A20-CXP16	16	200	20	50	-	-	8.00	0	-5	3	-	22600	-	0.51	GI267	C0520
	20K3R050A20-CXP20	20	200	20	50	-	-	10.00	0	-5	3	-	20000	-	0.53	GI268	C0521
	20K3R060A25-CXP20	20	250	25	60	-	-	10.00	0	-5	3	-	20000	-	0.92	GI268	C0521
	25K3R060A25-CXP25	25	250	25	60	-	-	12.50	0	-5	3	-	20000	-	0.96	GI269	C0522
	32K3R080A32-CXP32	32	250	32	80	-	-	16.00	0	-5	3	-	15000	-	1.50	GI270	C0523
	16K3R060B20-CXP16	16	111	20	60	-	86.5	8.00	0	-5	3	-	22600	-	0.24	GI267	C0520
	20K3R070B25-CXP20	20	127	25	70	-	95.5	10.00	0	-5	3	-	20000	-	0.41	GI268	C0521
	25K3R080B25-CXP25	25	137	25	80	-	105	12.50	0	-5	3	-	20000	-	0.49	GI269	C0522
	16K3R035M08-CXP16	16	-	8.5	-	-	35	M8	8.00	0	-5	3	-	-	0.07	GI267	C0520
	16K3R035M10-CXP16	16	-	10.5	-	-	35	M10	8.00	0	-5	3	-	-	0.07	GI267	C0520
	20K3R040M10-CXP20	20	-	10.5	-	-	40	M10	10.00	0	-5	3	-	-	0.07	GI268	C0521
	25K3R045M12-CXP25	25	-	12.5	-	-	45	M12	12.50	0	-5	3	-	-	0.16	GI269	C0522
32K3R055M16-CXP32	32	-	17	-	-	55	M16	16.00	0	-5	3	-	-	0.29	GI270	C0523	

GI267		XP 16..
GI268		XP 20..
GI269		XP 25..
GI270		XP 32..

C0520	US 63009-T09P	1.2	M 3	9	Flag T09P
C0521	US 63513-T15P	3.0	M 3.5	12	Flag T15P



C0522	US 64014-T15P	3.5	M 4	14	Flag T15P
C0523	US 65017-T20P	5.0	M 5	17	Flag T20P

XP



	W1 [mm]	S [mm]
16	16.000	2.00
20	20.000	2.50
25	25.000	3.17
32	32.000	4.00

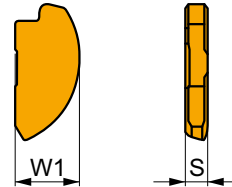

Suitability and starting values for cutting speed (vc), feed (f) and depth of cut (ap). Refer to our Machining Calculator app for further calculations.

Product	RE [mm]	P			M			K			N			S			H		
		vc [m/min]	f [mm/tooth]	ap [mm]	vc [m/min]	f [mm/tooth]	ap [mm]	vc [m/min]	f [mm/tooth]	ap [mm]	vc [m/min]	f [mm/tooth]	ap [mm]	vc [m/min]	f [mm/tooth]	ap [mm]	vc [m/min]	f [mm/tooth]	ap [mm]

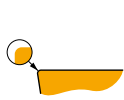

FM geometry with neutral design for light machining.

XP 16ER-FM	M8310	–	■	285	0.27	0.8	☑	145	0.24	0.8	■	270	0.27	0.8	–	–	–	–	–	–	■	55	0.15	1.0	
	M8330	–	■	265	0.27	0.8	☑	155	0.24	0.8	■	250	0.27	0.8	–	–	–	☑	65	0.19	0.6	☑	50	0.15	1.0
	M8345	–	■	195	0.27	0.8	☑	115	0.24	0.8	–	–	–	–	–	–	–	☑	45	0.19	0.6	–	–	–	
XP 20ER-FM	M8310	–	■	275	0.27	1.0	☑	140	0.24	1.0	■	260	0.27	1.0	–	–	–	–	–	–	■	55	0.15	1.0	
	M8330	–	■	260	0.27	1.0	☑	155	0.24	1.0	■	245	0.27	1.0	–	–	–	☑	65	0.19	0.8	☑	50	0.15	1.0
	M8345	–	■	190	0.27	1.0	☑	110	0.24	1.0	–	–	–	–	–	–	–	☑	45	0.19	0.8	–	–	–	
XP 25ER-FM	M8310	–	■	270	0.27	1.3	☑	135	0.24	1.3	■	255	0.27	1.3	–	–	–	–	–	–	■	50	0.15	1.0	
	M8330	–	■	250	0.27	1.3	☑	150	0.24	1.3	■	235	0.27	1.3	–	–	–	☑	60	0.19	1.0	☑	50	0.15	1.0
XP 32ER-FM	M8310	–	■	265	0.27	1.6	☑	135	0.24	1.6	■	250	0.27	1.6	–	–	–	–	–	–	■	50	0.15	1.0	
	M8330	–	■	245	0.27	1.6	☑	145	0.24	1.6	■	230	0.27	1.6	–	–	–	☑	60	0.19	1.3	☑	45	0.15	1.0
	M8345	–	■	180	0.27	1.6	☑	105	0.24	1.6	–	–	–	–	–	–	–	☑	45	0.19	1.3	–	–	–	



	XP 16-FM	XP 20-FM	XP 25-FM	XP 32-FM
	8.0	10.0	12.5	16.0
	-	-	-	-

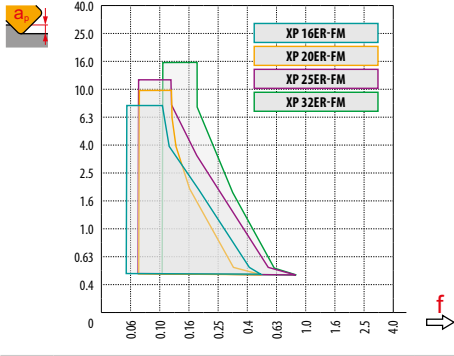

		0.3	0.4	0.5	0.7	1.0	1.25	1.5	2.0	2.5	3.0	4.0	5.0	6.0	8.0	10.0	12.0	15.0	16.0	20.0	22.5	25.0	
16		4.3	5.0	5.6	6.5	7.7	8.6	9.3	10.6	11.6	12.5	13.9	14.8	15.5	16.0	-	-	-	-	-	-	-	-
20		4.9	5.6	6.2	7.4	8.7	9.7	10.5	12.0	13.2	14.3	16.0	17.3	18.3	19.6	20.0	-	-	-	-	-	-	-
25		5.4	6.3	7.0	8.2	9.8	10.9	11.9	13.6	15.0	16.2	18.3	20.0	21.4	23.3	24.5	25.0	-	-	-	-	-	-
32		6.2	7.1	7.9	9.4	11.1	12.4	13.5	15.5	17.2	18.7	21.2	23.2	25.0	27.7	29.7	31.2	31.9	-	-	-	-	-

Effective area for 1 tool cutting edge.

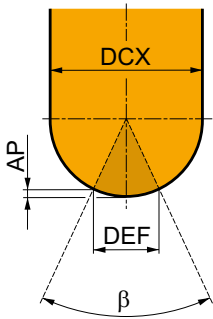



	β		AP
16	41°	5.568	0.51
20	37°	6.314	0.52
25	37°	7.901	0.65
32	37°	10.122	0.83



		3	5	10	15	20	30	40	50	60	80	100
16		0.438	0.566	0.800	0.980	1.131	1.386	1.600	1.789	1.960	2.263	2.530
20		0.490	0.632	0.894	1.095	1.265	1.549	1.789	2.000	2.191	2.530	2.828
25		0.548	0.707	1.000	1.225	1.414	1.732	2.000	2.236	2.449	2.828	3.162
32		0.620	0.800	1.131	1.386	1.600	1.960	2.263	2.530	2.771	3.200	3.578



	a_e	1.0 %	2.5 %	5.0 %	7.5 %	10 %	15 %	20 %	25 %	30 %	35 %	40 %	45 %	50 %	60 %	70 %	75 %	80 %	90 %	100 %	
																					
																					
19.9 %	1.0 %	2.86	1.84	1.33	1.12	1.00	0.89	-	-	-	-	-	-	-	-	-	-	-	-	-	-
31.2 %	2.5 %	3.58	2.28	1.64	1.36	1.20	1.01	0.92	0.88	0.91	-	-	-	-	-	-	-	-	-	-	-
43.6 %	5.0 %	4.22	2.68	1.92	1.58	1.39	1.16	1.03	0.95	0.90	0.88	0.89	-	-	-	-	-	-	-	-	-
52.7 %	7.5 %	4.63	2.95	2.10	1.73	1.51	1.26	1.11	1.02	0.96	0.91	0.89	0.88	0.90	-	-	-	-	-	-	-
60.0 %	10.0 %	4.94	3.14	2.24	1.84	1.61	1.33	1.18	1.07	1.00	0.95	0.91	0.89	0.88	1.00	-	-	-	-	-	-
71.4 %	15.0 %	5.39	3.42	2.43	2.00	1.74	1.44	1.27	1.15	1.07	1.01	0.96	0.93	0.90	0.88	0.93	-	-	-	-	-
80.0 %	20.0 %	5.70	3.62	2.57	2.11	1.84	1.52	1.33	1.21	1.12	1.05	1.00	0.96	0.93	0.89	0.88	0.89	1.00	-	-	-
86.6 %	25.0 %	5.93	3.76	2.67	2.20	1.91	1.58	1.38	1.25	1.16	1.08	1.03	0.99	0.95	0.90	0.88	0.88	0.89	-	-	-
91.7 %	30.0 %	6.10	3.87	2.75	2.26	1.96	1.62	1.42	1.28	1.18	1.11	1.05	1.01	0.97	0.92	0.89	0.88	0.88	0.93	-	-
95.4 %	35.0 %	6.23	3.95	2.80	2.30	2.00	1.65	1.44	1.31	1.20	1.13	1.07	1.02	0.98	0.93	0.89	0.88	0.88	0.90	-	-
98.0 %	40.0 %	6.31	4.00	2.84	2.33	2.03	1.67	1.46	1.32	1.22	1.14	1.08	1.03	0.99	0.93	0.90	0.89	0.88	0.89	-	-
99.5 %	45.0 %	6.36	4.03	2.86	2.35	2.04	1.68	1.47	1.33	1.23	1.15	1.09	1.04	1.00	0.94	0.90	0.89	0.88	0.88	-	-
100.0 %	50.0 %	6.38	4.04	2.87	2.35	2.05	1.69	1.48	1.33	1.23	1.15	1.09	1.04	1.00	0.94	0.90	0.89	0.88	0.88	1.00	-

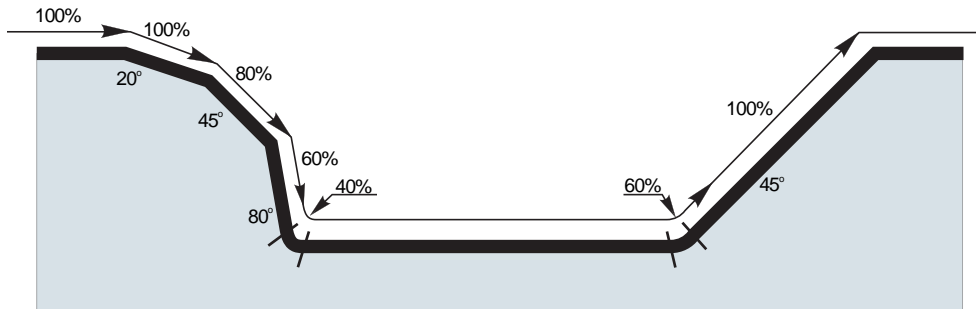

Overhang (multiple of diameter DCX)	<3.0	3.1 – 4.0	4.1 – 6.0	>6.1
Multiplication factor for speed	1.0	0.9	0.7	0.5



K2-SRC



PRAMET



Copy and Profile End Mills

Flexible end mill for a wide range of Die & Mold applications. One tool solution for ball-nosed and toroidal inserts. Available in cylindrical and modular style, in range Ø8 up to Ø32 mm. Body treated for longer tool life.

APMX	0.6 - 3.2 mm
------	--------------

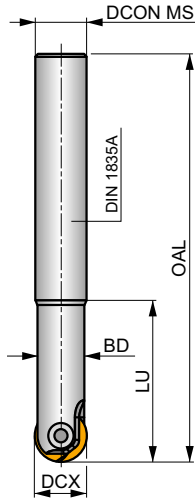
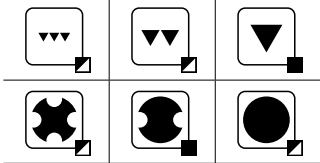
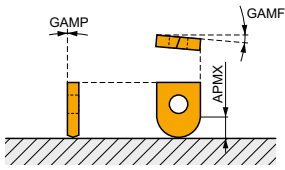

DCX 8 – 20 mm

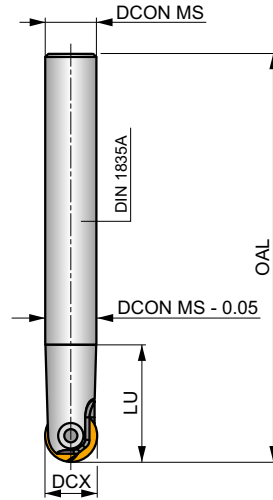

DCX 8 – 20 mm

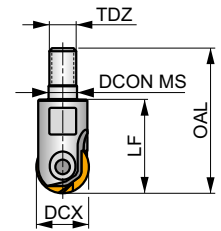

h_m 0.07 - 0.14



Product	DCX	OAL	DCON MS	BD	LU	LF	TDZ					kg		
	[mm]	[mm]	[mm]	[mm]	[mm]	[mm]								
08K2R025A10-SRC08-A	8	110	10	7.5	25	-	-	2	-	56000	-	0.09	GI030	C0530
08K2R050A12-SRC08-A	8	140	12	-	13.5	-	-	2	-	56000	-	0.11	GI030	C0530
10K2R030A12-SRC10-A	10	130	12	9	30	-	-	2	-	42000	-	0.11	GI031	C0531
10K2R060A16-SRC10-A	10	150	16	-	19.5	-	-	2	-	42000	-	0.18	GI031	C0531
12K2R030A12-SRC12-A	12	130	12	10.5	30	-	-	2	-	35000	-	0.11	GI032	C0532
16K2R035A16-SRC16-A	16	140	16	14	35	-	-	2	-	22000	-	0.23	GI033	C0533
20K2R045A20-SRC20-A	20	160	20	18	45	-	-	2	-	16000	-	0.40	GI034	C0534
25K2R045A25-SRC25-A	25	160	25	22.4	45	-	-	2	-	10000	-	0.59	GI035	C0535
32K2R060A32-SRC32-A	32	180	32	28.6	60	-	-	2	-	6000	-	1.10	GI036	C0536
12K2R060A16-SRC12-A	12	160	16	-	24.5	-	-	2	-	35000	-	0.14	GI032	C0532
16K2R065A20-SRC16-A	16	175	20	-	31.5	-	-	2	-	22000	-	0.41	GI033	C0533
20K2R080A25-SRC20-A	20	190	25	-	33.5	-	-	2	-	16000	-	0.66	GI034	C0534
08K2R30M06-SRC08-A	8	45	6.5	-	-	30	M6	2	-	-	-	0.02	GI123	C0530
10K2R30M06-SRC10-A	10	45	6.5	-	-	30	M6	2	-	-	-	0.03	GI124	C0531
12K2R30M06-SRC12-A	12	45	6.5	-	-	30	M6	2	-	-	-	0.16	GI125	C0530
12K2R30M08-SRC12-A	12	48	8.5	-	-	30	M8	2	-	-	-	0.04	GI125	C0532
16K2R35M08-SRC16-A	16	53	8.5	-	-	35	M8	2	-	-	-	0.05	GI033	C0533
20K2R35M10-SRC20-A	20	54	10.5	-	-	35	M10	2	-	-	-	0.08	GI034	C0534

GI030	RC 08	RC 08-F	LC 08-KP	LC 08-KPF	-	-	-
GI031	RC 10	RC 10-F	LC 10-KP	LC 10-KPF	-	-	-
GI032	RC 12	RC 12-F	-	-	LC 12..-CH	-	LC 12..-RE
GI033	RC 16	RC 16-F	-	-	-	-	-
GI034	RC 20	RC 20-F	-	-	-	-	-
GI035	RC 25	RC 25-F	-	-	-	-	-



GI036	RC 32	RC 32-F	-	-	-	-	-	-
GI123	RC 08	RC 08-F	-	-	-	-	-	-
GI124	RC 10	RC 10-F	-	-	-	-	-	-
GI125	RC 12	RC 12-F	-	-	-	-	-	-

C0530	CS 3007-T08P	1.2	M 3	7	-	-	-	Flag T08P
C0531	CS 4008-T15P	3.0	M 4	8	-	D-T08P/T15P	FG-15	-
C0532	CS 5009-T20P	5.0	M 5	9	SDRT20P	-	-	-
C0533	CS 5013-T20P	5.0	M 5	13	SDRT20P	-	-	-
C0534	CS 5015-T20P	5.0	M 5	15	SDRT20P	-	-	-
C0535	CS 6020-T20P	7.5	M 6	20	SDRT20P	-	-	-
C0536	CS 8025-T30P	15.0	M 8	25	SDRT30P	-	-	-

RC



	CDI	D1	INSL	S
	[mm]	[mm]	[mm]	[mm]
08	8.0	3.00	9.5	2.00
10	10.0	4.00	11.5	2.50
12	12.0	5.00	12.0	2.50
16	16.0	5.00	14.0	3.00
20	20.0	5.00	16.0	3.00
25	25.0	6.00	21.5	4.00
32	32.0	8.00	25.8	5.00

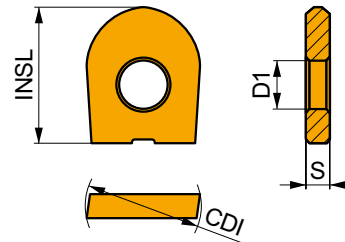

Suitability and starting values for cutting speed (vc), feed (f) and depth of cut (ap). Refer to our Machining Calculator app for further calculations.

Product	RE	P			M			K			N			S			H		
		vc	f	ap	vc	f	ap	vc	f	ap	vc	f	ap	vc	f	ap	vc	f	ap
	[mm]	[m/min]	[mm/tooth]	[mm]	[m/min]	[mm/tooth]	[mm]	[m/min]	[mm/tooth]	[mm]	[m/min]	[mm/tooth]	[mm]	[m/min]	[mm/tooth]	[mm]	[m/min]	[mm/tooth]	[mm]

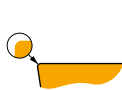

Neutral face with a positive cutting edge design.

RC 08	M4310	-	255	0.36	0.4	-	-	-	240	0.36	0.4	-	-	-	-	-	-	50	0.15	1.0
	M8310	-	295	0.36	0.4	-	-	-	280	0.36	0.4	-	-	-	-	-	-	55	0.15	1.0
	M8330	-	275	0.36	0.4	-	-	-	260	0.36	0.4	-	-	-	-	-	-	55	0.15	1.0
RC 10	M4310	-	250	0.36	0.5	-	-	-	235	0.36	0.5	-	-	-	-	-	-	50	0.15	1.0
	M8310	-	290	0.36	0.5	-	-	-	275	0.36	0.5	-	-	-	-	-	-	55	0.15	1.0
	M8330	-	270	0.36	0.5	-	-	-	255	0.36	0.5	-	-	-	-	-	-	50	0.15	1.0
RC 12	M4310	-	245	0.36	0.6	-	-	-	230	0.36	0.6	-	-	-	-	-	-	45	0.15	1.0
	M8310	-	285	0.36	0.6	-	-	-	270	0.36	0.6	-	-	-	-	-	-	55	0.15	1.0
	M8330	-	265	0.36	0.6	-	-	-	250	0.36	0.6	-	-	-	-	-	-	50	0.15	1.0
RC 16	M4310	-	235	0.36	0.8	-	-	-	220	0.36	0.8	-	-	-	-	-	-	45	0.15	1.0
	M8310	-	275	0.36	0.8	-	-	-	260	0.36	0.8	-	-	-	-	-	-	55	0.15	1.0
	M8330	-	255	0.36	0.8	-	-	-	240	0.36	0.8	-	-	-	-	-	-	50	0.15	1.0
RC 20	M4310	-	235	0.36	1.0	-	-	-	220	0.36	1.0	-	-	-	-	-	-	45	0.15	1.0
	M8310	-	270	0.36	1.0	-	-	-	255	0.36	1.0	-	-	-	-	-	-	50	0.15	1.0
	M8330	-	250	0.36	1.0	-	-	-	235	0.36	1.0	-	-	-	-	-	-	50	0.15	1.0
RC 25	M4310	-	225	0.36	1.3	-	-	-	210	0.36	1.3	-	-	-	-	-	-	45	0.15	1.0
	M8310	-	260	0.36	1.3	-	-	-	245	0.36	1.3	-	-	-	-	-	-	50	0.15	1.0
	M8330	-	245	0.36	1.3	-	-	-	230	0.36	1.3	-	-	-	-	-	-	45	0.15	1.0
RC 32	M4310	-	220	0.36	1.6	-	-	-	205	0.36	1.6	-	-	-	-	-	-	40	0.15	1.0
	M8310	-	240	0.36	1.6	-	-	-	225	0.36	1.6	-	-	-	-	-	-	45	0.15	1.0
	M8330	-	240	0.36	1.6	-	-	-	225	0.36	1.6	-	-	-	-	-	-	45	0.15	1.0



Suitability and starting values for cutting speed (vc), feed (f) and depth of cut (ap). Refer to our Machining Calculator app for further calculations.

Product	RE [mm]	P			M			K			N			S			H		
		vc [m/min]	f [mm/tooth]	ap [mm]	vc [m/min]	f [mm/tooth]	ap [mm]	vc [m/min]	f [mm/tooth]	ap [mm]	vc [m/min]	f [mm/tooth]	ap [mm]	vc [m/min]	f [mm/tooth]	ap [mm]	vc [m/min]	f [mm/tooth]	ap [mm]



F geometry is sharp and suitable for finish machining.

RC 08-F	M4310	-	255	0.36	0.4	130	0.32	0.4	240	0.36	0.4	-	-	-	-	-	-	50	0.15	1.0
RC 10-F	M4310	-	250	0.36	0.5	125	0.32	0.5	235	0.36	0.5	-	-	-	-	-	-	50	0.15	1.0
RC 12-F	M4310	-	245	0.36	0.6	120	0.32	0.6	230	0.36	0.6	-	-	-	-	-	-	45	0.15	1.0
RC 16-F	M4310	-	235	0.36	0.8	115	0.32	0.8	220	0.36	0.8	-	-	-	-	-	-	45	0.15	1.0
RC 20-F	M8330	-	255	0.36	0.8	150	0.32	0.8	240	0.36	0.8	-	-	-	-	-	-	50	0.15	1.0
	M4310	-	235	0.36	1.0	115	0.32	1.0	220	0.36	1.0	-	-	-	-	-	-	45	0.15	1.0
	M8330	-	250	0.36	1.0	150	0.32	1.0	235	0.36	1.0	-	-	-	-	-	-	50	0.15	1.0

LC



	CDI [mm]	D1 [mm]	L [mm]	S [mm]
08	8.0	3.00	9.50	2.00
10	10.0	4.00	11.50	2.50
12	12.0	5.00	14.00	2.50
16	16.0	5.00	16.00	3.00
20	20.0	5.00	18.00	3.00

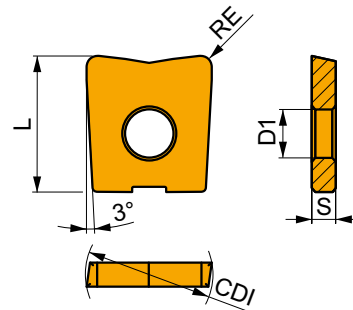

Suitability and starting values for cutting speed (vc), feed (f) and depth of cut (ap). Refer to our Machining Calculator app for further calculations.

Product	RE [mm]	P			M			K			N			S			H		
		vc [m/min]	f [mm/tooth]	ap [mm]	vc [m/min]	f [mm/tooth]	ap [mm]	vc [m/min]	f [mm/tooth]	ap [mm]	vc [m/min]	f [mm/tooth]	ap [mm]	vc [m/min]	f [mm/tooth]	ap [mm]	vc [m/min]	f [mm/tooth]	ap [mm]



KP geometry with zero rake angle design for light to medium machining.

LC 0806-KP	M4310	0.6	280	0.16	0.3	-	-	-	265	0.16	0.3	-	-	-	-	-	-	55	0.15	1.0
	M8310	0.6	325	0.16	0.3	-	-	-	305	0.16	0.3	-	-	-	-	-	-	65	0.15	1.0
	M8330	0.6	295	0.16	0.3	-	-	-	280	0.16	0.3	-	-	-	-	-	-	55	0.15	1.0
LC 0810-KP	M4310	1.0	280	0.16	0.5	-	-	-	265	0.16	0.5	-	-	-	-	-	-	55	0.15	1.0
	M8310	1.0	325	0.16	0.5	-	-	-	305	0.16	0.5	-	-	-	-	-	-	65	0.15	1.0
LC 1008-KP	M4310	0.8	270	0.16	0.4	-	-	-	255	0.16	0.4	-	-	-	-	-	-	50	0.15	1.0
	M8310	0.8	315	0.16	0.4	-	-	-	295	0.16	0.4	-	-	-	-	-	-	60	0.15	1.0
	M8330	0.8	290	0.16	0.4	-	-	-	275	0.16	0.4	-	-	-	-	-	-	55	0.15	1.0
LC 1010-KP	M4310	1.0	280	0.16	0.5	-	-	-	265	0.16	0.5	-	-	-	-	-	-	55	0.15	1.0
	M8310	1.0	325	0.16	0.5	-	-	-	305	0.16	0.5	-	-	-	-	-	-	65	0.15	1.0
	M8330	1.0	295	0.16	0.5	-	-	-	280	0.16	0.5	-	-	-	-	-	-	55	0.15	1.0
LC 1210-KP	M4310	1.0	280	0.16	0.5	-	-	-	265	0.16	0.5	-	-	-	-	-	-	55	0.15	1.0
	M8310	1.0	325	0.16	0.5	-	-	-	305	0.16	0.5	-	-	-	-	-	-	65	0.15	1.0
	M8330	1.0	295	0.16	0.5	-	-	-	280	0.16	0.5	-	-	-	-	-	-	55	0.15	1.0
LC 1220-KP	M4310	2.0	285	0.16	1.0	-	-	-	270	0.16	1.0	-	-	-	-	-	-	55	0.15	1.0
LC 1610-KP	M4310	1.0	280	0.16	0.5	-	-	-	265	0.16	0.5	-	-	-	-	-	-	55	0.15	1.0
	M8310	1.0	325	0.16	0.5	-	-	-	305	0.16	0.5	-	-	-	-	-	-	65	0.15	1.0
	M8330	1.0	295	0.16	0.5	-	-	-	280	0.16	0.5	-	-	-	-	-	-	55	0.15	1.0
LC 1613-KP	M4310	1.3	270	0.16	0.7	-	-	-	255	0.16	0.7	-	-	-	-	-	-	50	0.15	1.0
	M8310	1.3	315	0.16	0.7	-	-	-	295	0.16	0.7	-	-	-	-	-	-	60	0.15	1.0
LC 1630-KP	M4310	3.0	270	0.16	1.5	-	-	-	255	0.16	1.5	-	-	-	-	-	-	50	0.15	1.0
LC 2010-KP	M4310	1.0	280	0.16	0.5	-	-	-	265	0.16	0.5	-	-	-	-	-	-	55	0.15	1.0
	M8310	1.0	325	0.16	0.5	-	-	-	305	0.16	0.5	-	-	-	-	-	-	65	0.15	1.0
	M8330	1.0	295	0.16	0.5	-	-	-	280	0.16	0.5	-	-	-	-	-	-	55	0.15	1.0



Suitability and starting values for cutting speed (vc), feed (f) and depth of cut (ap). Refer to our Machining Calculator app for further calculations.

Product	RE (mm)	P			M			K			N			S			H		
		vc [m/min]	f [mm/tooth]	ap [mm]	vc [m/min]	f [mm/tooth]	ap [mm]	vc [m/min]	f [mm/tooth]	ap [mm]	vc [m/min]	f [mm/tooth]	ap [mm]	vc [m/min]	f [mm/tooth]	ap [mm]	vc [m/min]	f [mm/tooth]	ap [mm]



KP geometry with zero rake angle design for light to medium machining.

LC 2016-KP	M4310	1.6	280	0.16	0.8	—	—	—	265	0.16	0.8	—	—	—	—	—	—	—	55	0.15	1.0
	M8310	1.6	325	0.16	0.8	—	—	—	305	0.16	0.8	—	—	—	—	—	—	—	65	0.15	1.0
LC 2040-KP	M8330	4.0	285	0.16	2.0	—	—	—	270	0.16	2.0	—	—	—	—	—	—	—	55	0.15	1.0

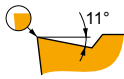

KPF geometry with positive design for light to medium machining.

LC 0806-KPF	M4310	0.6	280	0.16	0.3	140	0.14	0.3	265	0.16	0.3	—	—	—	—	—	—	—	55	0.15	1.0
LC 1008-KPF	M4310	0.8	270	0.16	0.4	135	0.14	0.4	255	0.16	0.4	—	—	—	—	—	—	—	50	0.15	1.0
LC 1210-KPF	M4310	1.0	280	0.16	0.5	140	0.14	0.5	265	0.16	0.5	—	—	—	—	—	—	—	55	0.15	1.0
	M8330	1.0	295	0.16	0.5	175	0.14	0.5	280	0.16	0.5	—	—	—	—	—	—	—	55	0.15	1.0
LC 1613-KPF	M4310	1.3	270	0.16	0.7	135	0.14	0.7	255	0.16	0.7	—	—	—	—	—	—	—	50	0.15	1.0
LC 2016-KPF	M4310	1.6	280	0.16	0.8	140	0.14	0.8	265	0.16	0.8	—	—	—	—	—	—	—	55	0.15	1.0

LC 12-CH



CDI (mm)	D1 (mm)	L (mm)	S (mm)
1245	12.0	5.00	14.00

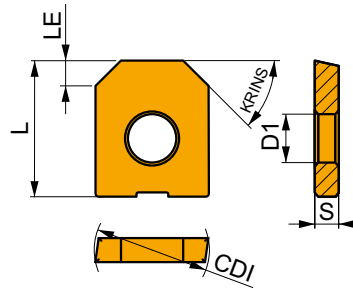

Suitability and starting values for cutting speed (vc), feed (f) and depth of cut (ap). Refer to our Machining Calculator app for further calculations.

Product	RE (mm)	P			M			K			N			S			H		
		vc [m/min]	f [mm/tooth]	ap [mm]	vc [m/min]	f [mm/tooth]	ap [mm]	vc [m/min]	f [mm/tooth]	ap [mm]	vc [m/min]	f [mm/tooth]	ap [mm]	vc [m/min]	f [mm/tooth]	ap [mm]	vc [m/min]	f [mm/tooth]	ap [mm]



CH geometry with zero rake angle design for light to medium machining.

LC 1245-CH	M4310	—	225	0.20	2.0	—	—	—	210	0.20	2.0	—	—	—	—	—	—	—	45	0.15	1.0
-------------------	--------------	---	-----	------	-----	---	---	---	-----	------	-----	---	---	---	---	---	---	---	----	------	-----



LC 12-RE

	CDI	D1	L	S
	[mm]	[mm]	[mm]	[mm]
12	12.0	5.00	14.00	2.50

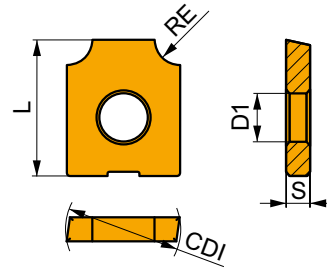

Suitability and starting values for cutting speed (vc), feed (f) and depth of cut (ap). Refer to our Machining Calculator app for further calculations.

Product	RE	P			M			K			N			S			H		
		vc	f	ap	vc	f	ap	vc	f	ap	vc	f	ap	vc	f	ap	vc	f	ap
	[mm]	[m/min]	[mm/tooth]	[mm]	[m/min]	[mm/tooth]	[mm]	[m/min]	[mm/tooth]	[mm]	[m/min]	[mm/tooth]	[mm]	[m/min]	[mm/tooth]	[mm]	[m/min]	[mm/tooth]	[mm]

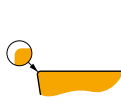

RE geometry with zero rake angle design for light to medium machining.

LC 1220-RE	M4310	2.0	295	0.10	2.0	—	—	—	280	0.10	2.0	—	—	—	—	—	—	—	55	0.15	1.0
LC 1230-RE	M4310	3.0	285	0.10	3.0	—	—	—	270	0.10	3.0	—	—	—	—	—	—	—	55	0.15	1.0



	RC 08	RC 10	RC 12	RC 16	RC 20	RC 25	RC 32
	4.0	5.0	6.0	8.0	10.0	12.5	16.0
	-	-	-	-	-	-	-

	RC 08-F	RC 10-F	RC 12-F	RC 16-F	RC 20-F
	4.0	5.0	6.0	8.0	10.0
	-	-	-	-	-

	LC 08-KP	LC 08-KP	LC 10-KP	LC 10-KP	LC 08-KPF	LC 10-KPF
	0.6	1.0	0.8	1.0	0.6	0.8
	-	-	-	-	-	-

	LC 1245-CH	LC 1260-CH	LC 1210-RE	LC 1220-RE	LC 1230-RE
	3×45	5×60	1.0	2.0	3.0
	-	-	-	-	-

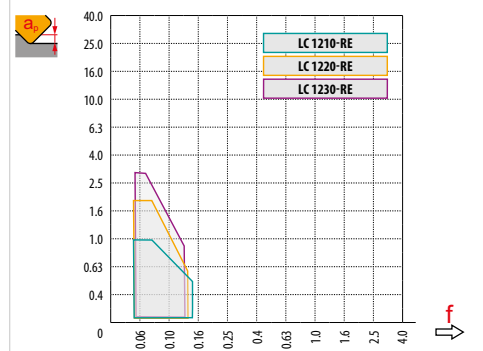
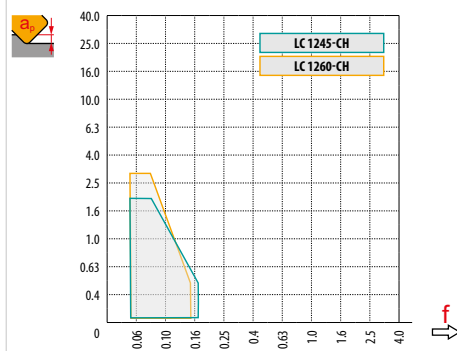
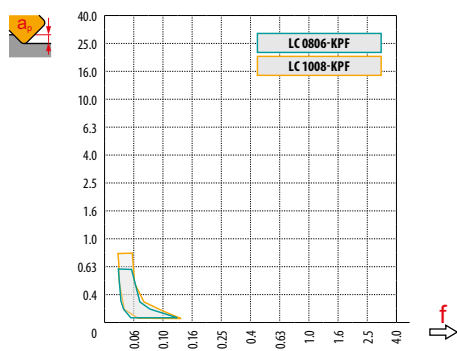
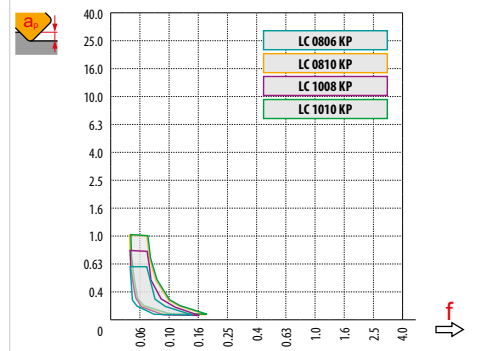
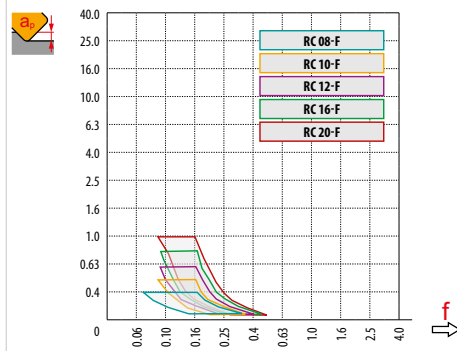
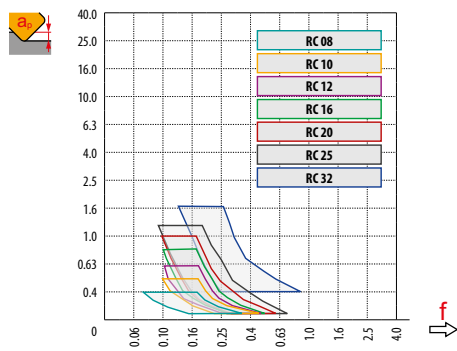



RC 08 / RC 08-F	8
RC 10 / RC 10-F	10
RC 12 / RC 12-F	12
RC 16 / RC 16-F	16
RC 20 / RC 20-F	20
RC 25 / RC 25-F	25
RC 32 / RC 32-F	32

	0.3	0.4	0.5	0.7	1.0	1.25	1.5	2.0	2.5	3.0	4.0	5.0	6.0	8.0	10.0	12.0	15.0	16.0
	3.0	3.5	3.9	4.5	5.3	5.8	6.2	6.9	7.4	7.7	8.0	-	-	-	-	-	-	-
	3.4	3.9	4.4	5.1	6.0	6.6	7.1	8.0	8.7	9.2	9.8	10.0	-	-	-	-	-	-
	3.7	4.3	4.8	5.6	6.6	7.3	7.9	8.9	9.7	10.4	11.3	11.8	12.0	-	-	-	-	-
	4.3	5.0	5.6	6.5	7.7	8.6	9.3	10.6	11.6	12.5	13.9	14.8	15.5	16.0	-	-	-	-
	4.9	5.6	6.2	7.4	8.7	9.7	10.5	12.0	13.2	14.3	16.0	17.3	18.3	19.6	20.0	-	-	-
	5.4	6.3	7.0	8.2	9.8	10.9	11.9	13.6	15.0	16.2	18.3	20.0	21.4	23.3	24.5	25.0	-	-
	6.17	7.11	7.94	9.36	11.14	12.40	13.53	15.49	17.18	18.65	21.17	23.24	24.98	27.71	29.66	30.98	31.94	32.00



RC 08 / RC 08-F	8
RC 10 / RC 10-F	10
RC 12 / RC 12-F	12
RC 16 / RC 16-F	16
RC 20 / RC 20-F	20
RC 25 / RC 25-F	25
RC 32 / RC 32-F	32

	3	5	10	15	20	30	40	50	60	80	100
	0.310	0.400	0.566	0.693	0.800	0.980	1.131	1.265	1.386	1.600	1.789
	0.346	0.447	0.632	0.775	0.894	1.095	1.265	1.414	1.549	1.789	2.000
	0.379	0.490	0.693	0.849	0.980	1.200	1.386	1.549	1.697	1.960	2.191
	0.438	0.566	0.800	0.980	1.131	1.386	1.600	1.789	1.960	2.263	2.530
	0.490	0.632	0.894	1.095	1.265	1.549	1.789	2.000	2.191	2.530	2.828
	0.548	0.707	1.000	1.225	1.414	1.732	2.000	2.236	2.449	2.828	3.162
	0.620	0.800	1.131	1.386	1.600	1.960	2.263	2.530	2.771	3.200	3.578

	a_e	1.0%	2.5%	5.0%	7.5%	10%	15%	20%	25%	30%	35%	40%	45%	50%	60%	70%	75%	80%	90%	100%
19.9%	1.0%	2.86	1.84	1.33	1.12	1.00	0.89	-	-	-	-	-	-	-	-	-	-	-	-	-
31.2%	2.5%	3.58	2.28	1.64	1.36	1.20	1.01	0.92	0.88	0.91	-	-	-	-	-	-	-	-	-	-
43.6%	5.0%	4.22	2.68	1.92	1.58	1.39	1.16	1.03	0.95	0.90	0.88	0.89	-	-	-	-	-	-	-	-
52.7%	7.5%	4.63	2.95	2.10	1.73	1.51	1.26	1.11	1.02	0.96	0.91	0.89	0.88	0.90	-	-	-	-	-	-
60.0%	10.0%	4.94	3.14	2.24	1.84	1.61	1.33	1.18	1.07	1.00	0.95	0.91	0.89	0.88	1.00	-	-	-	-	-
71.4%	15.0%	5.39	3.42	2.43	2.00	1.74	1.44	1.27	1.15	1.07	1.01	0.96	0.93	0.90	0.88	0.93	-	-	-	-
80.0%	20.0%	5.70	3.62	2.57	2.11	1.84	1.52	1.33	1.21	1.12	1.05	1.00	0.96	0.93	0.89	0.88	0.89	1.00	-	-
86.6%	25.0%	5.93	3.76	2.67	2.20	1.91	1.58	1.38	1.25	1.16	1.08	1.03	0.99	0.95	0.90	0.88	0.88	0.89	-	-
91.7%	30.0%	6.10	3.87	2.75	2.26	1.96	1.62	1.42	1.28	1.18	1.11	1.05	1.01	0.97	0.92	0.89	0.88	0.88	0.93	-
95.4%	35.0%	6.23	3.95	2.80	2.30	2.00	1.65	1.44	1.31	1.20	1.13	1.07	1.02	0.98	0.93	0.89	0.88	0.88	0.90	-
98.0%	40.0%	6.31	4.00	2.84	2.33	2.03	1.67	1.46	1.32	1.22	1.14	1.08	1.03	0.99	0.93	0.90	0.89	0.88	0.89	-
99.5%	45.0%	6.36	4.03	2.86	2.35	2.04	1.68	1.47	1.33	1.23	1.15	1.09	1.04	1.00	0.94	0.90	0.89	0.88	0.88	-
100.0%	50.0%	6.38	4.04	2.87	2.35	2.05	1.69	1.48	1.33	1.23	1.15	1.09	1.04	1.00	0.94	0.90	0.89	0.88	0.88	1.00

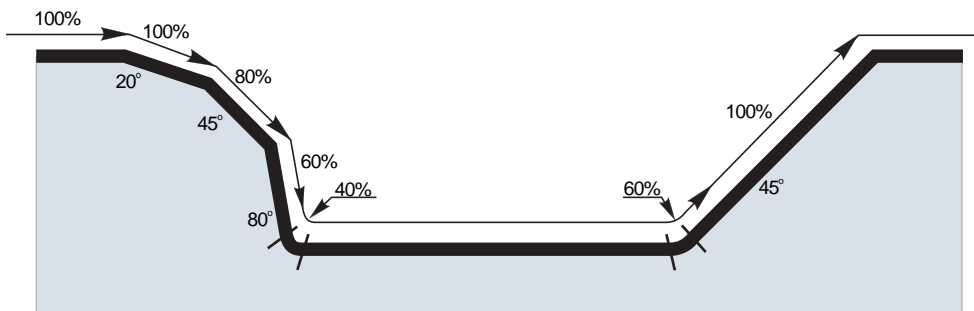



	DCX	RE															
			0.00	0.30	0.40	0.50	0.60	0.70	0.80	0.90	1.00	1.25	1.50	2.00	2.50	3.00	4.00
LC 0806-KP	8	0.6	6.8	7.8	7.9	8.0	8.0	-	-	-	-	-	-	-	-	-	-
LC 0806-KPF		0.6	6.8	7.8	7.9	8.0	8.0	-	-	-	-	-	-	-	-	-	-
LC 0810-KP		1.0	6.0	7.4	7.6	7.7	7.8	7.9	8.0	8.0	8.0	-	-	-	-	-	-
LC 1008-KP	10	0.8	8.4	9.6	9.8	9.9	9.9	10.0	10.0	-	-	-	-	-	-	-	-
LC 1008-KPF		0.8	8.4	9.6	9.8	9.9	9.9	10.0	10.0	-	-	-	-	-	-	-	-
LC 1010-KP		1.0	8.0	9.4	9.6	9.7	9.8	9.9	10.0	10.0	10.0	-	-	-	-	-	-
LC 1245-CH	12	3×45	8.0	8.6	8.8	9.0	9.2	9.4	9.6	9.8	10.0	10.5	11.0	12.0	-	-	-
LC 1260-CH		5×60	9.7	10.0	10.2	10.3	10.4	10.5	10.6	10.7	10.8	11.1	11.4	12.0	-	-	-
LC 1210-RE		1.0	10.0	10.1	10.2	10.3	10.4	10.6	10.8	11.1	12.0	-	-	-	-	-	-
LC 1220-RE		2.0	8.0	8.0	8.1	8.1	8.2	8.3	8.3	8.4	8.5	8.9	9.4	12.0	-	-	-
LC 1230-RE		3.0	6.0	6.0	6.1	6.1	6.1	6.2	6.2	6.3	6.3	6.5	6.8	7.5	8.7	12.0	-



DCX		3	5	10	15	20	30	40	50	60	80	100	
8		0.310	0.400	0.566	0.693	0.800	0.980	1.131	1.265	1.386	1.600	1.789	
		0.346	0.447	0.632	0.775	0.894	1.095	1.265	1.414	1.549	1.789	2.000	
RE		3	5	10	15	20	30	40	50	60	80	100	
		0.6	0.120	0.155	0.219	0.268	0.310	0.379	0.438	0.490	0.537	0.620	0.693
		0.8	0.139	0.179	0.253	0.310	0.358	0.438	0.506	0.566	0.620	0.716	0.800
1.0	0.155	0.200	0.283	0.346	0.400	0.490	0.566	0.632	0.693	0.800	0.89		



	DCX	RE	
LC 0806-KP	8	0.6	3.0
LC 0806-KPF		0.6	2.8
LC 0810-KP		1.0	3.0
LC 1008-KP	10	0.8	3.8
LC 1008-KPF		0.8	3.6
LC 1010-KP		1.0	3.8
LC 1245-CH	12	3×45	-
LC 1260-CH		5×60	-
LC 1210-RE		1.0	-
LC 1220-RE		2.0	-
LC 1230-RE		3.0	-



	DCX	RE	RPMX	APMX/I
LC 0806-KP	8	0.6	2.5	1.5/35
LC 0806-KPF		0.6	2.2	1.5/39
LC 0810-KP		1.0	2.4	1.5/36
LC 1008-KP	10	0.8	2.6	1.5/33
LC 1008-KPF		0.8	2.3	1.5/38
LC 1010-KP		1.0	2.6	1.5/33
LC 1245-CH	12	3×45	-	-
LC 1260-CH		5×60	-	-
LC 1210-RE		1.0	-	-
LC 1220-RE		2.0	-	-
LC 1230-RE		3.0	-	-



			DMIN	DMAX		
LC 0806-KP	8	0.6	9.8	15.9	0.8	1.0
LC 0806-KPF		0.6	10.2	15.9	0.1	0.1
LC 0810-KP		1.0	9.9	15.9	0.1	0.1
LC 1008-KP	10	0.8	12.2	19.9	0.9	1.1
LC 1008-KPF		0.8	12.6	19.9	0.2	0.2
LC 1010-KP		1.0	12.2	19.9	0.2	0.2
LC 1245-CH	12	3×45	–	–	–	–
LC 1260-CH		5×60	–	–	–	–
LC 1210-RE		1.0	–	–	–	–
LC 1220-RE		2.0	–	–	–	–
LC 1230-RE		3.0	–	–	–	–



LC 0806-KP	8	0.6	0.15
LC 0806-KPF		0.6	0.13
LC 0810-KP		1.0	0.13
LC 1008-KP	10	0.8	0.2
LC 1008-KPF		0.8	0.18
LC 1010-KP		1.0	0.19
LC 1245-CH	12	3×45	–
LC 1260-CH		5×60	–
LC 1210-RE		1.0	–
LC 1220-RE		2.0	–
LC 1230-RE		3.0	–



		Chamfer	Coefficient for speed	Feed for APMX		
LC 1245-CH	12	3 × 45	1.26	0.21		
LC 1260-CH		5 × 60	1.26	0.21		
Overhang (multiple of diameter DCX)		<3.0	3.0 – 3.5	3.6 – 4.0	4.1 – 4.5	>4.6
Multiplication factor for speed		1.0	0.9	0.8	0.7	0.5



K2-SLC



PRAMET

S



Copy and Profile End Mills for finishing

End mill for finishing operations in a wide range of applications utilising LC inserts. High precision ground inserts provide excellent accuracy. For profiling, chamfering, helical, progressive plunge milling and ramping. Available in cylindrical style only in range Ø12 up to Ø20 mm. Body treated for longer tool life.

APMX	1.0 - 3.0 mm
------	--------------

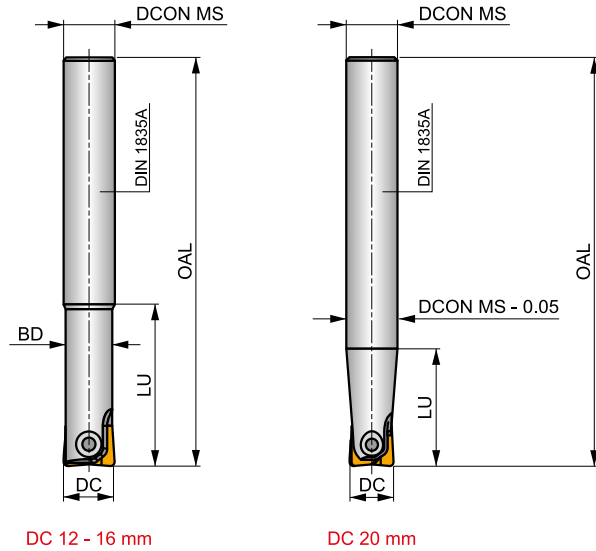
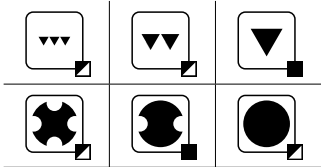
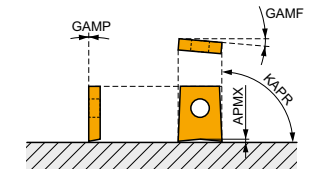

DC 12 - 16 mm

DC 20 mm

h_m 0.03 - 0.10



Product	DC	OAL	DCON MS	LU	BD							
	[mm]	[mm]	[mm]	[mm]	[mm]			max.		kg		
12K2R030A12-SLC12-A	12	130	12	30	10.5	2	-	35000	-	0.11	GI037	C0532
16K2R035A16-SLC16-A	16	140	16	35	14	2	-	22000	-	0.20	GI038	C0533
20K2R045A20-SLC20-A	20	160	20	45	18	2	-	16000	-	0.38	GI039	C0534

GI037	LC 12-KP	LC 12-KPF
GI038	LC 16-KP	LC 16-KPF
GI039	LC 20-KP	LC 20-KPF

C0532	CS 5009-T20P	5.0	M 5	9	SDR T20P
C0533	CS 5013-T20P	5.0	M 5	13	SDR T20P
C0534	CS 5015-T20P	5.0	M 5	15	SDR T20P



LC



	CDI	D1	L	S
	[mm]	[mm]	[mm]	[mm]
08	8.0	3.00	9.50	2.00
10	10.0	4.00	11.50	2.50
12	12.0	5.00	14.00	2.50
16	16.0	5.00	16.00	3.00
20	20.0	5.00	18.00	3.00

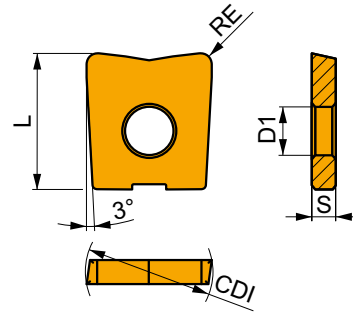

Suitability and starting values for cutting speed (vc), feed (f) and depth of cut (ap). Refer to our Machining Calculator app for further calculations.

Product	RE	P			M			K			N			S			H		
		vc	f	ap	vc	f	ap	vc	f	ap	vc	f	ap	vc	f	ap	vc	f	ap
	[mm]	[m/min]	[mm/tooth]	[mm]	[m/min]	[mm/tooth]	[mm]	[m/min]	[mm/tooth]	[mm]	[m/min]	[mm/tooth]	[mm]	[m/min]	[mm/tooth]	[mm]	[m/min]	[mm/tooth]	[mm]

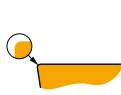

KP geometry with zero rake angle design for light to medium machining.

LC 0806-KP	M4310	0.6	280	0.16	0.3	-	-	-	265	0.16	0.3	-	-	-	-	-	-	55	0.15	1.0
	M8310	0.6	325	0.16	0.3	-	-	-	305	0.16	0.3	-	-	-	-	-	-	65	0.15	1.0
	M8330	0.6	295	0.16	0.3	-	-	-	280	0.16	0.3	-	-	-	-	-	-	55	0.15	1.0
LC 0810-KP	M4310	1.0	280	0.16	0.5	-	-	-	265	0.16	0.5	-	-	-	-	-	-	55	0.15	1.0
	M8310	1.0	325	0.16	0.5	-	-	-	305	0.16	0.5	-	-	-	-	-	-	65	0.15	1.0
LC 1008-KP	M4310	0.8	270	0.16	0.4	-	-	-	255	0.16	0.4	-	-	-	-	-	-	50	0.15	1.0
	M8310	0.8	315	0.16	0.4	-	-	-	295	0.16	0.4	-	-	-	-	-	-	60	0.15	1.0
	M8330	0.8	290	0.16	0.4	-	-	-	275	0.16	0.4	-	-	-	-	-	-	55	0.15	1.0
LC 1010-KP	M4310	1.0	280	0.16	0.5	-	-	-	265	0.16	0.5	-	-	-	-	-	-	55	0.15	1.0
	M8310	1.0	325	0.16	0.5	-	-	-	305	0.16	0.5	-	-	-	-	-	-	65	0.15	1.0
	M8330	1.0	295	0.16	0.5	-	-	-	280	0.16	0.5	-	-	-	-	-	-	55	0.15	1.0
LC 1210-KP	M4310	1.0	280	0.16	0.5	-	-	-	265	0.16	0.5	-	-	-	-	-	-	55	0.15	1.0
	M8310	1.0	325	0.16	0.5	-	-	-	305	0.16	0.5	-	-	-	-	-	-	65	0.15	1.0
	M8330	1.0	295	0.16	0.5	-	-	-	280	0.16	0.5	-	-	-	-	-	-	55	0.15	1.0
LC 1220-KP	M4310	2.0	285	0.16	1.0	-	-	-	270	0.16	1.0	-	-	-	-	-	-	55	0.15	1.0
LC 1610-KP	M4310	1.0	280	0.16	0.5	-	-	-	265	0.16	0.5	-	-	-	-	-	-	55	0.15	1.0
	M8310	1.0	325	0.16	0.5	-	-	-	305	0.16	0.5	-	-	-	-	-	-	65	0.15	1.0
	M8330	1.0	295	0.16	0.5	-	-	-	280	0.16	0.5	-	-	-	-	-	-	55	0.15	1.0
LC 1613-KP	M4310	1.3	270	0.16	0.7	-	-	-	255	0.16	0.7	-	-	-	-	-	-	50	0.15	1.0
	M8310	1.3	315	0.16	0.7	-	-	-	295	0.16	0.7	-	-	-	-	-	-	60	0.15	1.0
LC 1630-KP	M4310	3.0	270	0.16	1.5	-	-	-	255	0.16	1.5	-	-	-	-	-	-	50	0.15	1.0
LC 2010-KP	M4310	1.0	280	0.16	0.5	-	-	-	265	0.16	0.5	-	-	-	-	-	-	55	0.15	1.0
	M8310	1.0	325	0.16	0.5	-	-	-	305	0.16	0.5	-	-	-	-	-	-	65	0.15	1.0
	M8330	1.0	295	0.16	0.5	-	-	-	280	0.16	0.5	-	-	-	-	-	-	55	0.15	1.0
LC 2016-KP	M4310	1.6	280	0.16	0.8	-	-	-	265	0.16	0.8	-	-	-	-	-	-	55	0.15	1.0
	M8310	1.6	325	0.16	0.8	-	-	-	305	0.16	0.8	-	-	-	-	-	-	65	0.15	1.0
LC 2040-KP	M8330	4.0	285	0.16	2.0	-	-	-	270	0.16	2.0	-	-	-	-	-	-	55	0.15	1.0

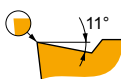

KPF geometry with positive design for light to medium machining.

LC 0806-KPF	M4310	0.6	280	0.16	0.3	140	0.14	0.3	265	0.16	0.3	-	-	-	-	-	-	55	0.15	1.0
LC 1008-KPF	M4310	0.8	270	0.16	0.4	135	0.14	0.4	255	0.16	0.4	-	-	-	-	-	-	50	0.15	1.0
LC 1210-KPF	M4310	1.0	280	0.16	0.5	140	0.14	0.5	265	0.16	0.5	-	-	-	-	-	-	55	0.15	1.0
	M8330	1.0	295	0.16	0.5	175	0.14	0.5	280	0.16	0.5	-	-	-	-	-	-	55	0.15	1.0
LC 1613-KPF	M4310	1.3	270	0.16	0.7	135	0.14	0.7	255	0.16	0.7	-	-	-	-	-	-	50	0.15	1.0
LC 2016-KPF	M4310	1.6	280	0.16	0.8	140	0.14	0.8	265	0.16	0.8	-	-	-	-	-	-	55	0.15	1.0



a_e / DC	5 %	10 %	15 %	20 %	25 %	30 %	40 %	50 %	60 %	70 %	75 %	80 %	90 %	100 %
X.V	1.48	1.35	1.27	1.22	1.19	1.16	1.11	1.08	1.05	1.03	1.00	1.00	1.00	1.00
x.f	2.20	1.60	1.35	1.20	1.10	0.95	0.85	0.75	0.85	0.95	1.00	1.00	1.00	1.00
x.f	0.64	0.64	0.64	0.64	0.64	0.65	0.65	0.67	0.68	0.71	0.72	0.74	0.79	1.00



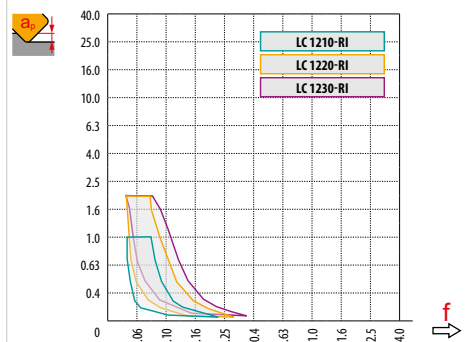
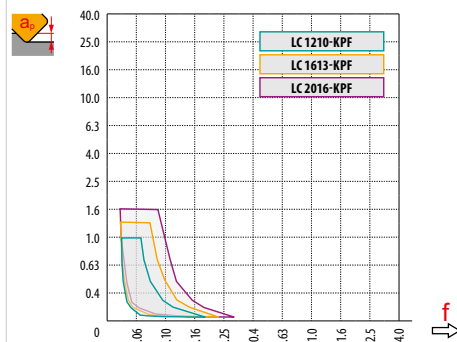
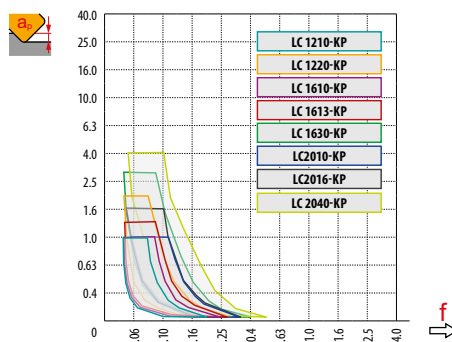

RE	LC 12-KP	LC 12-KP	LC 16-KP	LC 16-KP	LC 16-KP	LC 20-KP	LC 20-KP	LC 20-KP
BS	-	-	-	-	-	-	-	-

RE	LC 12-KPF	LC 16-KPF	LC 20-KP	LC 1215-RI	LC 1220-RI	LC 1230-RI
BS	-	-	-	-	-	-





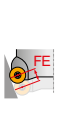

RE	DC	a_e	a_e														
			0.0	0.3	0.4	0.5	0.6	0.7	0.8	0.9	1.0	1.25	1.5	2.0	2.5	3.0	4.0
LC 1210-KP	12	1.0	10.0	11.4	11.6	11.7	11.8	11.9	12.0	12.0	12.0	-	-	-	-	-	-
LC 1210-KPF		1.0	10.0	11.4	11.6	11.7	11.8	11.9	12.0	12.0	12.0	-	-	-	-	-	-
LC 1220-KP		2.0	8.0	10.1	10.4	10.6	10.9	11.0	11.2	11.3	11.5	11.7	11.9	12.0	-	-	-
LC 1210-RI		1.0	10.0	11.4	11.6	11.7	11.8	11.9	12.0	12.0	12.0	-	-	-	-	-	-
LC 1220-RI		2.0	8.0	10.1	10.4	10.6	10.9	11.0	11.2	11.3	11.5	11.7	11.9	12.0	-	-	-
LC 1230-RI		3.0	6.0	8.6	9.0	9.3	9.6	9.9	10.1	10.3	10.5	10.9	11.2	11.7	11.9	-	-
LC 1610-KP	16	1.0	14.0	15.4	15.6	15.7	15.8	15.9	16.0	16.0	16.0	-	-	-	-	-	-
LC 1613-KP		1.3	13.4	15.1	15.3	15.4	15.6	15.7	15.8	15.9	15.9	16.0	-	-	-	-	-
LC 1613-KPF		1.3	13.4	15.1	15.3	15.4	15.6	15.7	15.8	15.9	15.9	16.0	-	-	-	-	-
LC 1630-KP	3.0	10.0	12.6	13.0	13.3	13.6	13.9	14.1	14.3	14.5	14.9	15.2	15.7	15.9	-	-	
LC 2010-KP	20	1.0	18.0	19.4	19.6	19.7	19.8	19.9	20.0	20.0	20.0	-	-	-	-	-	-
LC 2016-KP		1.6	16.8	18.7	18.9	19.1	19.3	19.4	19.6	19.7	19.8	19.9	20.0	-	-	-	-
LC 2016-KPF		1.6	16.8	18.7	18.9	19.1	19.3	19.4	19.6	19.7	19.8	19.9	20.0	-	-	-	-
LC 2040-KP		4.0	12.0	15.0	15.5	15.9	16.2	16.5	16.8	17.1	17.3	17.8	18.2	18.9	19.4	-	-







		3	5	10	15	20	30	40	50	60	80	100
12		0.379	0.490	0.693	0.849	0.980	1.200	1.386	1.549	1.697	1.960	2.191
16		0.438	0.566	0.800	0.980	1.131	1.386	1.600	1.789	1.960	2.263	2.530
20		0.490	0.632	0.894	1.095	1.265	1.549	1.789	2.000	2.191	2.530	2.828
		3	5	10	15	20	30	40	50	60	80	100
1.3		0.177	0.228	0.322	0.395	0.456	0.559	0.645	0.721	0.790	0.912	1.020
1.6		0.196	0.253	0.358	0.438	0.506	0.620	0.716	0.800	0.876	1.012	1.131
2.0		0.219	0.283	0.400	0.490	0.566	0.693	0.800	0.894	0.980	1.131	1.265
3.0		0.268	0.346	0.490	0.600	0.693	0.849	0.980	1.095	1.200	1.386	1.549
4.0		0.310	0.400	0.566	0.693	0.800	0.980	1.131	1.265	1.386	1.600	1.789







			
LC 1210-KP	12	1.0	4.8
LC 1210-KPF		1.0	4.4
LC 1220-KP		2.0	4.8
LC 1210-RI		1.0	–
LC 1220-RI		2.0	–
LC 1230-RI		3.0	–
LC 1610-KP	16	1.0	6.6
LC 1613-KP		1.3	6.6
LC 1613-KPF		1.3	5.9
LC 1630-KP		3.0	6.6
LC 2010-KP	20	1.0	8.5
LC 2016-KP		1.6	8.5
LC 2016-KPF		1.6	7.5
LC 2040-KP		4.0	8.5







				
LC 1210-KP	12	1.0	4.7	1.5/19
LC 1210-KPF		1.0	3.8	1.5/23
LC 1220-KP		2.0	4.4	2.0/26
LC 1210-RI		1.0	–	–
LC 1220-RI		2.0	–	–
LC 1230-RI		3.0	–	–
LC 1610-KP	16	1.0	4.8	1.5/18
LC 1613-KP		1.3	4.8	1.5/18
LC 1613-KPF		1.3	3.8	1.5/23
LC 1630-KP		3.0	4.4	3.0/39
LC 2010-KP	20	1.0	5.0	1.5/18
LC 2016-KP		1.6	4.9	1.6/19
LC 2016-KPF		1.6	3.8	1.6/25
LC 2040-KP		4.0	4.5	4.0/51



			DMIN	DMAX		
LC 1210-KP	12	1.0	14.1	23.9	1.0	1.2
LC 1210-KPF		1.0	15.0	23.9	0.4	0.4
LC 1220-KP		2.0	14.1	23.9	0.3	0.3
LC 1210-RI		1.0	–	–	–	–
LC 1220-RI		2.0	–	–	–	–
LC 1230-RI		3.0	–	–	–	–
LC 1610-KP	16	1.0	18.6	31.9	1.1	1.4
LC 1613-KP		1.3	18.6	31.9	0.6	0.6
LC 1613-KPF		1.3	19.9	31.9	0.5	0.5
LC 1630-KP		3.0	18.6	31.9	0.4	0.4
LC 2010-KP	20	1.0	22.8	39.9	1.3	1.5
LC 2016-KP		1.6	22.8	39.9	0.8	0.8
LC 2016-KPF		1.6	24.8	39.9	0.7	0.7
LC 2040-KP		4.0	22.8	39.9	0.5	0.5



			
LC 1210-KP	12	1.0	0.44
LC 1210-KPF		1.0	0.9
LC 1220-KP		2.0	0.4
LC 1210-RI		1.0	–
LC 1220-RI		2.0	–
LC 1230-RI		3.0	–
LC 1610-KP	16	1.0	0.65
LC 1613-KP		1.3	0.62
LC 1613-KPF		1.3	0.53
LC 1630-KP		3.0	0.44
LC 2010-KP	20	1.0	0.85
LC 2016-KP		1.6	0.79
LC 2016-KPF		1.6	0.67
LC 2040-KP		4.0	0.54

Overhang (multiple of diameter DC)	<3.0	3 – 3.5	3.6 – 4.0	4.1 – 4.5	>4.6
Multiplication factor for speed	1.0	0.9	0.8	0.7	0.5



K2-PPH

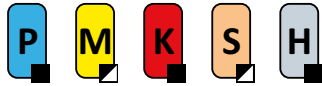

PRAMET

S



Copy and Profile End Mills

Flexible end mill for a wide range of Die & Mold applications. One tool solution for ball-nosed, toroidal and high-feed inserts. High precision ground inserts provide high accuracy. Available in cylindrical and modular style, in range Ø8 up to Ø32 mm. Body treated for longer tool life.

APMX	0.3 - 4.0 mm
------	--------------

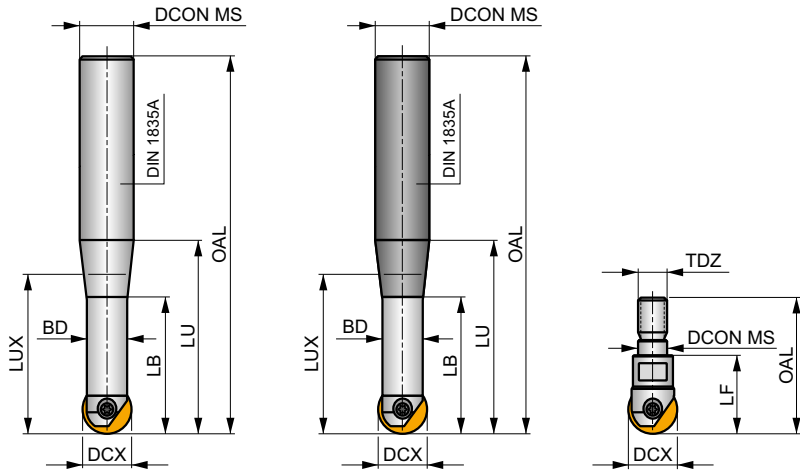
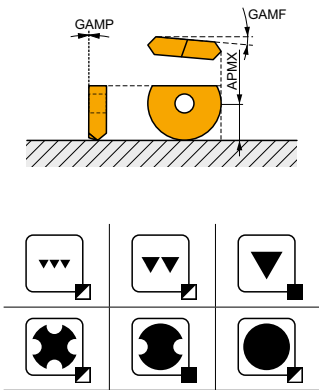

h_m 0.07 - 0.14



Product	DCX	OAL	DCON MS	BD	LB	LU	LUX	LF	TDZ	Carbide	max.	kg	GI	CO
	[mm]	[mm]	[mm]	[mm]	[mm]	[mm]	[mm]	[mm]	[mm]					
PPH-08/02-QC12-092	8	92	12	6.5	19	35	23.1	-	-	-	40000	-	0.14	GI284 C0540
PPH-08/02-QC12-110	8	110	12	6.5	33.5	53	41.5	-	-	-	33600	-	0.15	GI284 C0540
PPH-08/02-QC12-132	8	132	12	6.5	19	75	41.8	-	-	-	16800	-	0.16	GI284 C0540
PPH-10/02-QC12-092	10	92	12	8	22.4	38	30	-	-	-	40000	-	0.12	GI285 C0541
PPH-10/02-QC12-110	10	110	12	8	38.7	53	51.9	-	-	-	40000	-	0.15	GI285 C0541
PPH-10/02-QC12-132	10	132	12	8	21.8	75	73.6	-	-	-	20300	-	0.17	GI285 C0541
PPH-12/02-QC16-145	12	145	16	10	22.5	85	63.3	-	-	-	19800	-	0.25	GI286 C0542
PPH-16/02-QC20-166	16	166	20	14	29.5	100	75.5	-	-	-	20000	-	0.38	GI287 C0543
PPH-20/02-QC25-191	20	191	25	17	35	115	82.2	-	-	-	18400	-	0.64	GI288 C0544
PPH-25/02-QC32-215	25	215	32	21	42.5	135	97	-	-	-	16500	-	1.07	GI289 C0545
PPH-12/02-QC12-083	12	83	12	10	-	26	-	-	-	-	40000	-	0.15	GI286 C0542
PPH-12/02-QC12-110	12	110	12	10	-	53	-	-	-	-	40000	-	0.17	GI286 C0542
PPH-12/02-QC12-145	12	145	12	10	-	45	-	-	-	-	40000	-	0.20	GI286 C0542
PPH-16/02-QC16-092	16	92	16	14	-	92	-	-	-	-	36000	-	0.21	GI287 C0543
PPH-16/02-QC16-123	16	123	16	14	-	63	-	-	-	-	36000	-	0.24	GI287 C0543
PPH-16/02-QC16-166	16	166	16	14	-	55	-	-	-	-	36000	-	0.31	GI287 C0543
PPH-20/02-QC20-104	20	104	20	17	-	38	-	-	-	-	40000	-	0.35	GI288 C0544
PPH-20/02-QC20-141	20	141	20	17	-	75	-	-	-	-	40000	-	0.41	GI288 C0544
PPH-20/02-QC20-191	20	191	20	17	-	65	-	-	-	-	40000	-	0.54	GI288 C0544
PPH-25/02-QC25-121	25	121	25	21	-	45	-	-	-	-	40000	-	0.53	GI289 C0545
PPH-25/02-QC25-166	25	166	25	21	-	90	-	-	-	-	37100	-	0.57	GI289 C0545
PPH-32/02-QC32-186	32	186	32	26	-	107	-	-	-	-	32500	-	1.09	GI290 C0546
PPH-32/02-QC32-240	32	240	32	26	-	160	-	-	-	-	14500	-	1.37	GI290 C0546
PPH-08/02-QC12-110HSCW	8	110	12	6.5	19	53	30.1	-	-	✓	40000	-	0.21	GI284 C0540
PPH-08/02-QC12-132HSCW	8	132	12	6.5	19	75	37.1	-	-	✓	23400	-	0.24	GI284 C0540
PPH-10/02-QC12-092HSCW	10	92	12	8	21.9	38.1	90.9	-	-	✓	40000	-	0.20	GI285 C0541



Product	DCX	OAL	D CON IMS	BD	LB	LU	LUX	LF	TDZ	Carbide				
	[mm]	[mm]	[mm]	[mm]	[mm]	[mm]	[mm]	[mm]						
PPH-10/02-QC12-110HSCW	10	110	12	8	21.8	53.1	41.4	-	-	✓	40000	-	0.22	G1285 C0541
PPH-10/02-QC12-132HSCW	10	132	12	8	21.8	75.1	51.1	-	-	✓	23400	-	0.27	G1285 C0541
PPH-12/02-QC16-145HSCW	12	145	16	10	21.5	85	65.6	-	-	✓	21000	-	0.28	G1286 C0542
PPH-16/02-QC16-166HSCW	16	166	20	14	28.5	100	87.2	-	-	✓	25500	-	0.66	G1287 C0543
PPH-20/02-QC25-191HSCW	20	191	25	17	35	115	75.6	-	-	✓	18500	-	1.09	G1288 C0544
PPH-08/02-QC08-130HSCW	8	130	8	6.5	-	20	-	-	-	✓	40000	-	0.17	G1284 C0540
PPH-10/02-QC10-140HSCW	10	140	10	8	-	25	-	-	-	✓	40000	-	0.25	G1285 C0541
PPH-12/02-QC12-083HSCW	12	83	12	10	-	26	-	-	-	✓	40000	-	0.23	G1286 C0542
PPH-12/02-QC12-110HSCW	12	110	12	10	-	53	-	-	-	✓	40000	-	0.26	G1286 C0542
PPH-16/02-QC16-092HSCW	16	92	16	14	-	32	-	-	-	✓	43000	-	0.32	G1287 C0543
PPH-16/02-QC16-123HSCW	16	123	16	14	-	63	-	-	-	✓	43000	-	0.36	G1287 C0543
PPH-20/02-QC20-104HSCW	20	104	20	17	-	38	-	-	-	✓	40000	-	0.50	G1288 C0544
PPH-20/02-QC20-141HSCW	20	141	20	17	-	75	-	-	-	✓	40000	-	0.62	G1288 C0544
PPH-16/02-025-P08	16	-	8.5	-	-	-	-	25	M8	-	-	-	0.14	G1287 C0543
PPH-20/02-030-P10	20	-	10.5	-	-	-	-	30	M10	-	-	-	0.18	G1288 C0544

G1284	PPH 08..	-	PPHT 08..	PPHF 08..
G1285	PPH 10..	PPHE 10..	PPHT 10..	PPHF 10..
G1286	PPH 12..	PPHE 12..	PPHT 12..	PPHF 12..
G1287	PPH 16..	PPHE 16..	PPHT 16..	PPHF 16..
G1288	PPH 20..	PPHE 20..	PPHT 20..	PPHF 20..
G1289	PPH 25..	-	PPHT 25..	PPHF 25..
G1290	PPH 32..	-	-	-

C0540	CS 42506-T07P	1.0	M 2.5	6	D-T07P/T09P	FG-15	-	-
C0541	CS 43008-T08P	1.2	M 3	8	D-T08P/T15P	FG-15	-	-
C0542	CS 43509-T10P	2.0	M 3.5	9	-	-	SDR T10P	-
C0543	CS 44013-T15P	3.0	M 4	13	D-T08P/T15P	FG-15	-	-
C0544	CS 45016-T20P	5.0	M 5	16	-	-	SDR T20P	-
C0545	CS 46020-T25P	7.5	M 6	20	-	-	-	SDR T25P-T
C0546	CS 48025-T40P	15.0	M 8	25	-	-	-	SDR T40P-T



PPH

	CDI	D1	INSL	S
	[mm]	[mm]	[mm]	[mm]
0800	8.0	2.50	7.0	2.40
1000	10.0	3.00	8.5	2.60
1200	12.0	3.50	10.0	3.00
1600	16.0	4.00	12.0	4.00
2000	20.0	5.00	15.0	5.00
2500	25.0	6.00	18.5	6.00
3000	30.0	8.00	22.5	7.00
3200	32.0	8.00	23.5	7.00

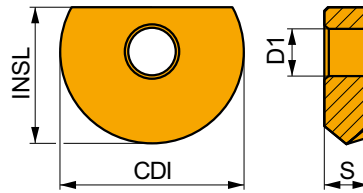

Suitability and starting values for cutting speed (vc), feed (f) and depth of cut (ap). Refer to our Machining Calculator app for further calculations.

Product	RE	P			M			K			N			S			H		
		vc	f	ap	vc	f	ap	vc	f	ap	vc	f	ap	vc	f	ap	vc	f	ap
	[mm]	[m/min]	[mm/tooth]	[mm]	[m/min]	[mm/tooth]	[mm]	[m/min]	[mm/tooth]	[mm]	[m/min]	[mm/tooth]	[mm]	[m/min]	[mm/tooth]	[mm]	[m/min]	[mm/tooth]	[mm]

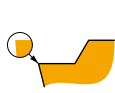

CL1 geometry with sharp design.

PPH 0800-CL1	2003	-	285	0.36	0.4	145	0.32	0.4	270	0.36	0.4	-	-	-	-	-	-	55	0.15	1.0
PPH 1000-CL1	2003	-	280	0.36	0.5	140	0.32	0.5	265	0.36	0.5	-	-	-	-	-	-	55	0.15	1.0
PPH 1200-CL1	2003	-	275	0.36	0.6	140	0.32	0.6	260	0.36	0.6	-	-	-	-	-	-	55	0.15	1.0
PPH 1600-CL1	2003	-	265	0.36	0.8	135	0.32	0.8	250	0.36	0.8	-	-	-	-	-	-	50	0.15	1.0
PPH 2000-CL1	2003	-	260	0.36	1.0	130	0.32	1.0	245	0.36	1.0	-	-	-	-	-	-	50	0.15	1.0
PPH 2500-CL1	2003	-	250	0.36	1.3	125	0.32	1.3	235	0.36	1.3	-	-	-	-	-	-	50	0.15	1.0
PPH 3000-CL1	2003	-	245	0.36	1.5	120	0.32	1.5	230	0.36	1.5	-	-	-	-	-	-	45	0.15	1.0
PPH 3200-CL1	2003	-	245	0.36	1.6	120	0.32	1.6	230	0.36	1.6	-	-	-	-	-	-	45	0.15	1.0

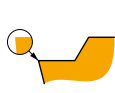

CL4 geometry with sharp design for interrupted cuts.

PPH 0800-CL4	8215	-	270	0.36	0.4	-	-	-	255	0.36	0.4	-	-	-	-	-	-	50	0.15	1.0
PPH 1000-CL4	8215	-	265	0.36	0.5	-	-	-	250	0.36	0.5	-	-	-	-	-	-	50	0.15	1.0
PPH 1200-CL4	8215	-	255	0.36	0.6	-	-	-	240	0.36	0.6	-	-	-	-	-	-	50	0.15	1.0
PPH 1600-CL4	8215	-	250	0.36	0.8	-	-	-	235	0.36	0.8	-	-	-	-	-	-	50	0.15	1.0
PPH 2000-CL4	8215	-	245	0.36	1.0	-	-	-	230	0.36	1.0	-	-	-	-	-	-	45	0.15	1.0
PPH 2500-CL4	8215	-	240	0.36	1.3	-	-	-	225	0.36	1.3	-	-	-	-	-	-	45	0.15	1.0
PPH 3000-CL4	8215	-	235	0.36	1.5	-	-	-	220	0.36	1.5	-	-	-	-	-	-	45	0.15	1.0
PPH 3200-CL4	8215	-	235	0.36	1.6	-	-	-	220	0.36	1.6	-	-	-	-	-	-	45	0.15	1.0

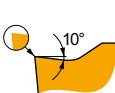

SM1 geometry with sharp design.

PPHE 1000-SM1	8215	-	260	0.31	0.5	155	0.28	0.5	245	0.31	0.5	-	-	-	-	-	-	50	0.15	1.0
PPHE 1200-SM1	8215	-	245	0.36	0.6	145	0.32	0.6	230	0.36	0.6	-	-	-	-	-	-	45	0.15	1.0
PPHE 1600-SM1	8215	-	250	0.31	0.8	150	0.28	0.8	235	0.31	0.8	-	-	-	-	-	-	50	0.15	1.0
PPHE 2000-SM1	8215	-	240	0.31	1.0	140	0.28	1.0	225	0.31	1.0	-	-	-	-	-	-	45	0.15	1.0



PPHF

	BS	LE	CDI	D1	INSL	S
	[mm]	[mm]	[mm]	[mm]	[mm]	[mm]
0800	0.40	2.60	8.0	2.50	7.0	2.40
1000	0.50	3.20	10.0	3.00	8.5	2.60
1200	0.60	3.90	12.0	3.50	10.0	3.00
1600	0.80	5.20	16.0	4.00	12.0	4.00
2000	1.00	6.40	20.0	5.00	15.0	5.00
2500	1.20	7.90	25.0	6.00	18.5	6.00

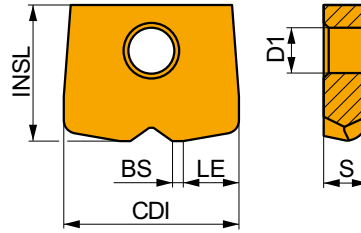

Suitability and starting values for cutting speed (vc), feed (f) and depth of cut (ap). Refer to our Machining Calculator app for further calculations.

Product	RE	P			M			K			N			S			H		
		vc	f	ap	vc	f	ap	vc	f	ap	vc	f	ap	vc	f	ap	vc	f	ap
	[mm]	[m/min]	[mm/tooth]	[mm]	[m/min]	[mm/tooth]	[mm]	[m/min]	[mm/tooth]	[mm]	[m/min]	[mm/tooth]	[mm]	[m/min]	[mm/tooth]	[mm]	[m/min]	[mm/tooth]	[mm]

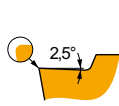

CE1 geometry with strong design for high feed machining.

PPHF 080004-CE1	M8330	-	200	0.30	0.3	120	0.27	0.3	190	0.30	0.3	-	-	-	50	0.27	0.2	40	0.15	1.0
PPHF 100005-CE1	M8330	-	190	0.35	0.3	110	0.32	0.3	180	0.35	0.3	-	-	-	45	0.32	0.2	35	0.15	1.0
PPHF 120006-CE1	M8330	-	205	0.45	0.4	120	0.41	0.4	190	0.45	0.4	-	-	-	50	0.41	0.3	40	0.15	1.0
PPHF 160008-CE1	M8330	-	190	0.60	0.5	110	0.54	0.5	180	0.60	0.5	-	-	-	45	0.54	0.4	35	0.15	1.0
PPHF 200010-CE1	M8330	-	190	0.70	0.6	110	0.63	0.6	180	0.70	0.6	-	-	-	45	0.63	0.5	35	0.15	1.0
PPHF 250012-CE1	M8330	-	175	0.90	0.8	105	0.81	0.8	165	0.90	0.8	-	-	-	40	0.81	0.6	35	0.15	1.0

PPHT

	CDI	D1	INSL	S
	[mm]	[mm]	[mm]	[mm]
0800	8.0	2.50	7.0	2.40
1000	10.0	3.00	8.5	2.60
1200	12.0	3.50	10.0	3.00
1600	16.0	4.00	12.0	4.00
2000	20.0	5.00	15.0	5.00
2500	25.0	6.00	18.5	6.00

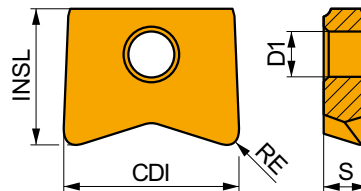

Suitability and starting values for cutting speed (vc), feed (f) and depth of cut (ap). Refer to our Machining Calculator app for further calculations.

Product	RE	P			M			K			N			S			H		
		vc	f	ap	vc	f	ap	vc	f	ap	vc	f	ap	vc	f	ap	vc	f	ap
	[mm]	[m/min]	[mm/tooth]	[mm]	[m/min]	[mm/tooth]	[mm]	[m/min]	[mm/tooth]	[mm]	[m/min]	[mm/tooth]	[mm]	[m/min]	[mm/tooth]	[mm]	[m/min]	[mm/tooth]	[mm]

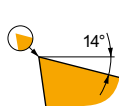
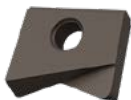

A2 geometry with positive design for light to medium machining.

PPHT 080003-A2	2003	0.3	275	0.10	0.3	140	0.09	0.3	260	0.10	0.3	-	-	-	-	-	-	55	0.15	1.0
PPHT 080005-A2	2003	0.5	270	0.13	0.3	135	0.12	0.3	255	0.13	0.3	-	-	-	-	-	-	50	0.15	1.0
PPHT 080008-A2	2003	0.8	305	0.14	0.4	155	0.13	0.4	285	0.14	0.4	-	-	-	-	-	-	60	0.15	1.0
PPHT 080010-A2	2003	1.0	315	0.14	0.5	160	0.13	0.5	295	0.14	0.5	-	-	-	-	-	-	60	0.15	1.0
PPHT 100005-A2	2003	0.5	270	0.13	0.3	135	0.12	0.3	255	0.13	0.3	-	-	-	-	-	-	50	0.15	1.0
PPHT 100008-A2	2003	0.8	305	0.14	0.4	155	0.13	0.4	285	0.14	0.4	-	-	-	-	-	-	60	0.15	1.0
PPHT 100010-A2	2003	1.0	315	0.14	0.5	160	0.13	0.5	295	0.14	0.5	-	-	-	-	-	-	60	0.15	1.0
PPHT 120005-A2	2003	0.5	270	0.13	0.3	135	0.12	0.3	255	0.13	0.3	-	-	-	-	-	-	50	0.15	1.0
PPHT 120010-A2	2003	1.0	315	0.14	0.5	160	0.13	0.5	295	0.14	0.5	-	-	-	-	-	-	60	0.15	1.0
PPHT 120020-A2	2003	2.0	320	0.14	1.0	160	0.13	1.0	300	0.14	1.0	-	-	-	-	-	-	60	0.15	1.0



Suitability and starting values for cutting speed (vc), feed (f) and depth of cut (ap). Refer to our Machining Calculator app for further calculations.

Product	RE [mm]	P			M			K			N			S			H		
		vc [m/min]	f [mm/tooth]	ap [mm]	vc [m/min]	f [mm/tooth]	ap [mm]	vc [m/min]	f [mm/tooth]	ap [mm]	vc [m/min]	f [mm/tooth]	ap [mm]	vc [m/min]	f [mm/tooth]	ap [mm]	vc [m/min]	f [mm/tooth]	ap [mm]

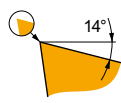
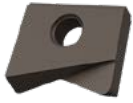

A2 geometry with positive design for light to medium machining.

PPHT 160010-A2	2003	1.0	315	0.14	0.5	160	0.13	0.5	295	0.14	0.5	-	-	-	-	-	-	60	0.15	1.0
PPHT 160013-A2	2003	1.3	300	0.15	0.6	150	0.13	0.6	285	0.15	0.6	-	-	-	-	-	-	60	0.15	1.0
PPHT 160020-A2	2003	2.0	320	0.14	1.0	160	0.13	1.0	300	0.14	1.0	-	-	-	-	-	-	60	0.15	1.0
PPHT 160030-A2	2003	3.0	305	0.14	1.5	155	0.13	1.5	285	0.14	1.5	-	-	-	-	-	-	60	0.15	1.0
PPHT 200010-A2	2003	1.0	315	0.14	0.5	160	0.13	0.5	295	0.14	0.5	-	-	-	-	-	-	60	0.15	1.0
PPHT 200016-A2	2003	1.6	310	0.14	0.8	155	0.13	0.8	290	0.14	0.8	-	-	-	-	-	-	60	0.15	1.0
PPHT 200030-A2	2003	3.0	305	0.14	1.5	155	0.13	1.5	285	0.14	1.5	-	-	-	-	-	-	60	0.15	1.0
PPHT 200040-A2	2003	4.0	295	0.14	2.0	150	0.13	2.0	280	0.14	2.0	-	-	-	-	-	-	55	0.15	1.0
PPHT 250020-A2	2003	2.0	320	0.14	1.0	160	0.13	1.0	300	0.14	1.0	-	-	-	-	-	-	60	0.15	1.0



a_s DCX	5 %	10 %	15 %	20 %	25 %	30 %	40 %	50 %	60 %	70 %	75 %	80 %	90 %	100 %
	1.48	1.35	1.27	1.22	1.19	1.16	1.11	1.08	1.05	1.03	1.00	1.00	1.00	1.00
	2.20	1.60	1.35	1.20	1.10	0.95	0.85	0.75	0.85	0.95	1.00	1.00	1.00	1.00
	0.64	0.64	0.64	0.64	0.64	0.65	0.65	0.67	0.68	0.71	0.72	0.74	0.79	1.00

	PPH 08-CL1	PPH 10-CL1	PPH 12-CL1	PPH 16-CL1	PPH 20-CL1	PPH 25-CL1	PPH 30-CL1	PPH 32-CL1
	4.0	5.0	6.0	8.0	10.0	12.5	15.0	16.0
	-	-	-	-	-	-	-	-

	PPH 08-CL4	PPH 10-CL4	PPH 12-CL4	PPH 16-CL4	PPH 20-CL4	PPH 25-CL4	PPH 30-CL4	PPH 32-CL4
	4.0	5.0	6.0	8.0	10.0	12.5	15.0	16.0
	-	-	-	-	-	-	-	-

	PPHE 10-SM1	PPHE 12-SM1	PPHE 16-SM1	PPHE 20-SM1
	5.0	6.0	8.0	10.0
	-	-	-	-

	PPHF 08-CE1	PPHF 10-CE1	PPHF 12-CE1	PPHF 16-CE1	PPHF 20-CE1	PPHF 25-CE1
	0.6	0.8	1.0	1.3	1.6	1.9
	0.40	0.50	0.60	0.80	1.00	1.20

	PPHT 08-A2	PPHT 08-A2	PPHT 08-A2	PPHT 08-A2	PPHT 10-A2	PPHT 10-A2	PPHT 10-A2	PPHT 12-A2	PPHT 12-A2	PPHT 12-A2	PPHT 16-A2
	0.3	0.5	0.8	1.0	0.5	0.8	1.0	0.5	1.0	2.0	1.0
	-	-	-	-	-	-	-	-	-	-	-

	PPHT 16-A2	PPHT 16-A2	PPHT 16-A2	PPHT 20-A2	PPHT 20-A2	PPHT 20-A2	PPHT 25-A2
	1.3	2.0	3.0	1.0	1.6	3.0	4.0
	-	-	-	-	-	-	-

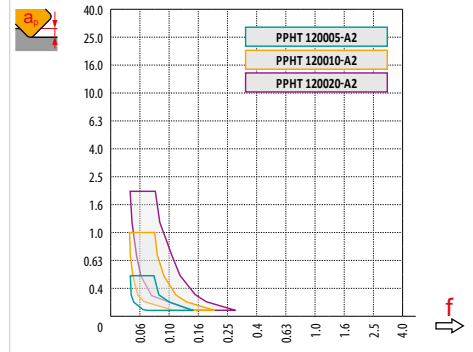
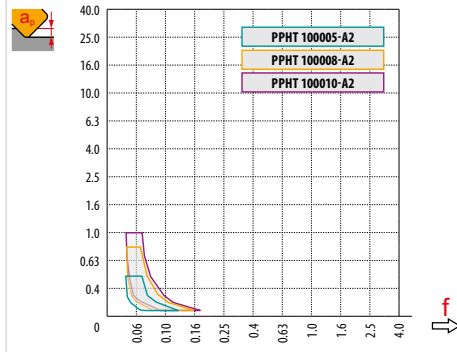
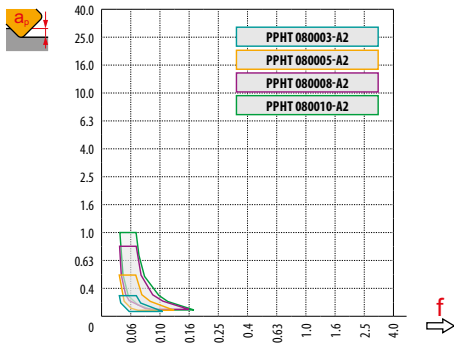
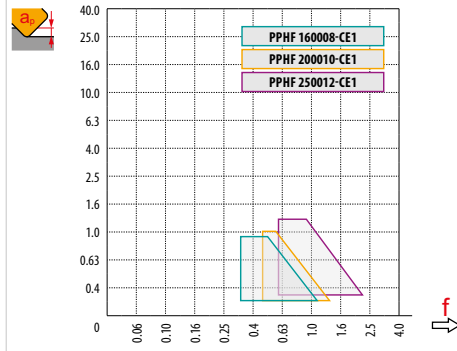
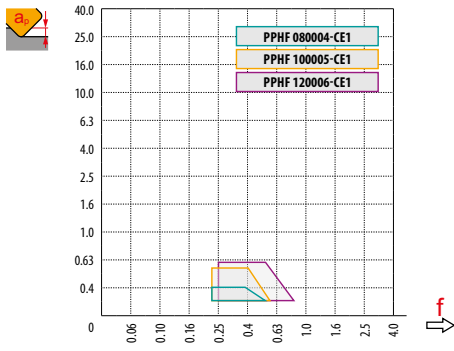
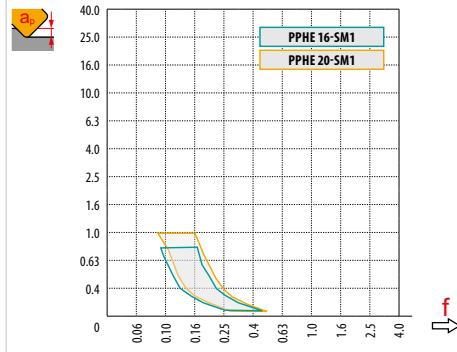
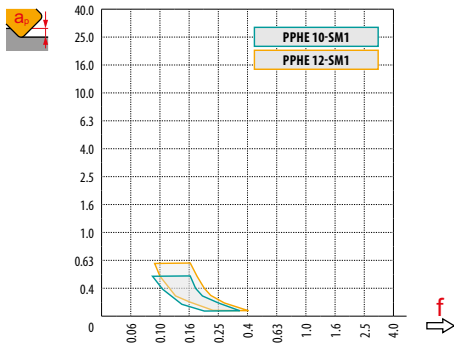
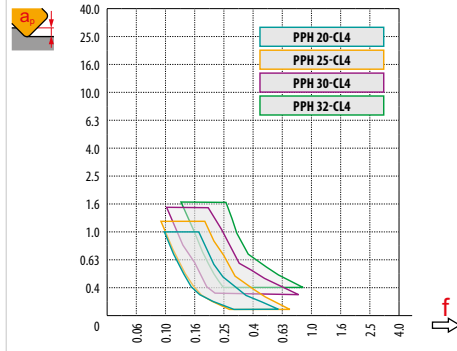
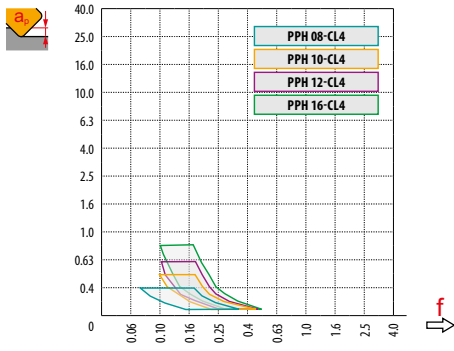
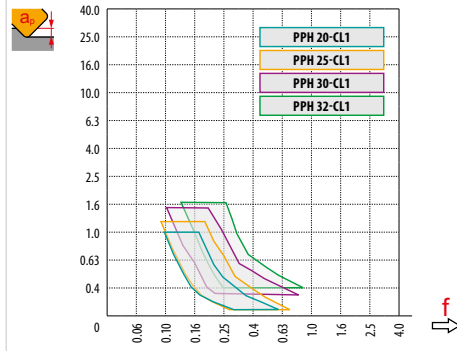
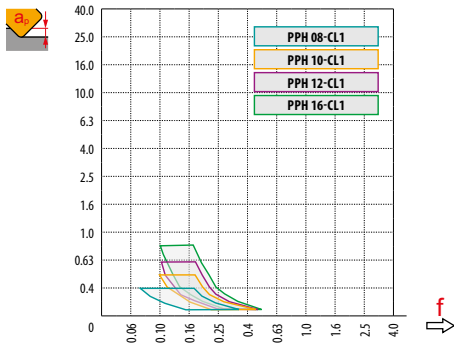

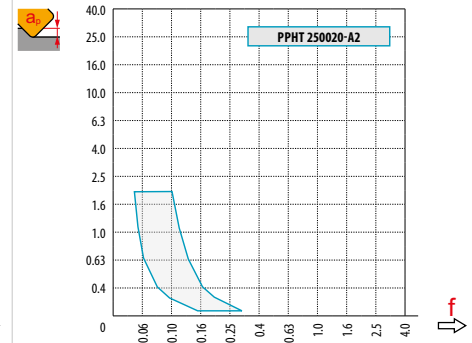
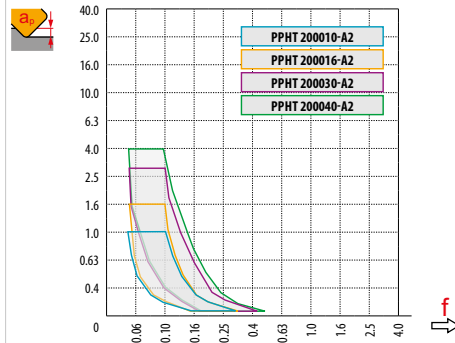
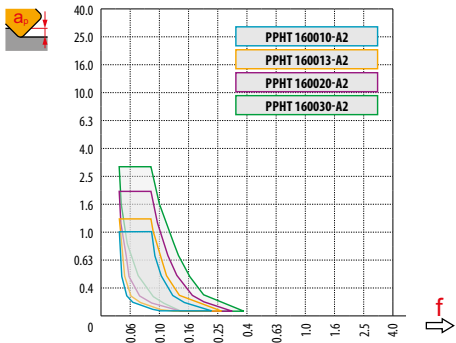



PPH	DCX	DEF	f																
			0.3	0.4	0.5	0.7	1.0	1.25	1.5	2.0	2.5	3.0	4.0	5.0	6.0	8.0	10.0	12.0	15.0
PPH 08	8		3.0	3.5	3.9	4.5	5.3	5.8	6.2	6.9	7.4	7.7	8.0	-	-	-	-	-	-
PPH 10	10		3.4	3.9	4.4	5.1	6.0	6.6	7.1	8.0	8.7	9.2	9.8	10.0	-	-	-	-	-
PPH 12	12		3.7	4.3	4.8	5.6	6.6	7.3	7.9	8.9	9.7	10.4	11.3	11.8	12.0	-	-	-	-
PPH 16	16		4.3	5.0	5.6	6.5	7.7	8.6	9.3	10.6	11.6	12.5	13.9	14.8	15.5	16.0	-	-	-
PPH 20	20		4.9	5.6	6.2	7.4	8.7	9.7	10.5	12.0	13.2	14.3	16.0	17.3	18.3	19.6	20.0	-	-
PPH 25	25		5.4	6.3	7.0	8.2	9.8	10.9	11.9	13.6	15.0	16.2	18.3	20.0	21.4	23.3	24.5	25.0	-
PPH 30	30		5.97	6.88	7.68	9.06	10.77	11.99	13.08	14.97	16.58	18.00	20.40	22.36	24.00	26.53	28.28	29.39	30.00
PPH 32	32		6.17	7.11	7.94	9.36	11.14	12.40	13.53	15.49	17.18	18.65	21.17	23.24	24.98	27.71	29.66	30.98	31.94





PPH	DCX	FE	μm										
			3	5	10	15	20	30	40	50	60	80	100
PPH 08	8		0.310	0.400	0.566	0.693	0.800	0.980	1.131	1.265	1.386	1.600	1.789
PPH 10	10		0.346	0.447	0.632	0.775	0.894	1.095	1.265	1.414	1.549	1.789	2.000
PPH 12	12		0.379	0.490	0.693	0.849	0.980	1.200	1.386	1.549	1.697	1.960	2.191
PPH 16	16		0.438	0.566	0.800	0.980	1.131	1.386	1.600	1.789	1.960	2.263	2.530
PPH 20	20		0.490	0.632	0.894	1.095	1.265	1.549	1.789	2.000	2.191	2.530	2.828
PPH 25	25		0.548	0.707	1.000	1.225	1.414	1.732	2.000	2.236	2.449	2.828	3.162
PPH 30	30		0.600	0.775	1.095	1.342	1.549	1.897	2.191	2.449	2.683	3.098	3.464
PPH 32	32		0.620	0.800	1.131	1.386	1.600	1.960	2.263	2.530	2.771	3.200	3.578









	a_e	1%	2.5%	5%	7.5%	10%	15%	20%	25%	30%	35%	40%	45%	50%	60%	70%	75%	80%	90%	100%
																				
19.9%	1.0%	2.86	1.84	1.33	1.12	1.00	0.89	–	–	–	–	–	–	–	–	–	–	–	–	–
31.2%	2.5%	3.58	2.28	1.64	1.36	1.20	1.01	0.92	0.88	0.91	–	–	–	–	–	–	–	–	–	–
43.6%	5.0%	4.22	2.68	1.92	1.58	1.39	1.16	1.03	0.95	0.90	0.88	0.89	–	–	–	–	–	–	–	–
52.7%	7.5%	4.63	2.95	2.10	1.73	1.51	1.26	1.11	1.02	0.96	0.91	0.89	0.88	0.90	–	–	–	–	–	–
60.0%	10.0%	4.94	3.14	2.24	1.84	1.61	1.33	1.18	1.07	1.00	0.95	0.91	0.89	0.88	1.00	–	–	–	–	–
71.4%	15.0%	5.39	3.42	2.43	2.00	1.74	1.44	1.27	1.15	1.07	1.01	0.96	0.93	0.90	0.88	0.93	–	–	–	–
80.0%	20.0%	5.70	3.62	2.57	2.11	1.84	1.52	1.33	1.21	1.12	1.05	1.00	0.96	0.93	0.89	0.88	0.89	1.00	–	–
86.6%	25.0%	5.93	3.76	2.67	2.20	1.91	1.58	1.38	1.25	1.16	1.08	1.03	0.99	0.95	0.90	0.88	0.88	0.89	–	–
91.7%	30.0%	6.10	3.87	2.75	2.26	1.96	1.62	1.42	1.28	1.18	1.11	1.05	1.01	0.97	0.92	0.89	0.88	0.88	0.93	–
95.4%	35.0%	6.23	3.95	2.80	2.30	2.00	1.65	1.44	1.31	1.20	1.13	1.07	1.02	0.98	0.93	0.89	0.88	0.88	0.90	–
98.0%	40.0%	6.31	4.00	2.84	2.33	2.03	1.67	1.46	1.32	1.22	1.14	1.08	1.03	0.99	0.93	0.90	0.89	0.88	0.89	–
99.5%	45.0%	6.36	4.03	2.86	2.35	2.04	1.68	1.47	1.33	1.23	1.15	1.09	1.04	1.00	0.94	0.90	0.89	0.88	0.88	–
100.0%	50.0%	6.38	4.04	2.87	2.35	2.05	1.69	1.48	1.33	1.23	1.15	1.09	1.04	1.00	0.94	0.90	0.89	0.88	0.88	1.00









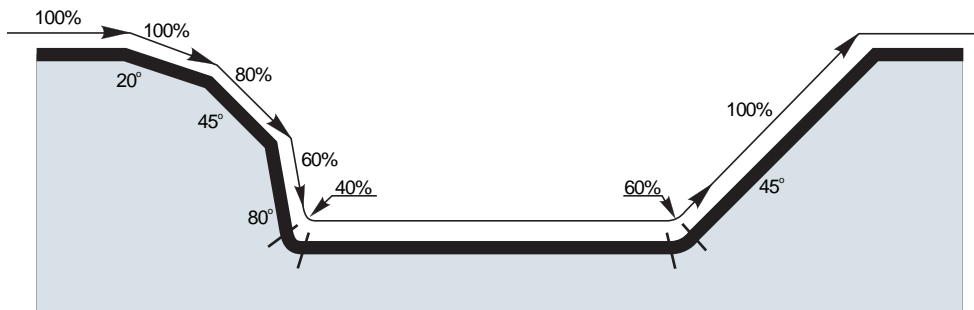

			0.0	0.3	0.4	0.5	0.6	0.7	0.8	0.9	1.0	1.25	1.5	2.0	2.5	3.0	4.0
PPHT 08-A2	8	0.3	7.4	8.0	–	–	–	–	–	–	–	–	–	–	–	–	–
PPHT 08-A2		0.5	7.0	7.9	8.0	8.0	–	–	–	–	–	–	–	–	–	–	–
PPHT 08-A2		0.8	6.4	7.6	7.8	7.9	7.9	8.0	8.0	–	–	–	–	–	–	–	–
PPHT 08-A2		1.0	6.0	7.4	7.6	7.7	7.8	7.9	8.0	8.0	8.0	–	–	–	–	–	–
PPHT 10-A2	10	0.5	9.0	9.9	10.0	10.0	–	–	–	–	–	–	–	–	–	–	–
PPHT 10-A2		0.8	8.4	9.6	9.8	9.9	9.9	10.0	10.0	–	–	–	–	–	–	–	–
PPHT 10-A2		1.0	8.0	9.4	9.6	9.7	9.8	9.9	10.0	10.0	10.0	–	–	–	–	–	–
PPHT 12-A2	12	0.5	11.0	11.9	12.0	12.0	–	–	–	–	–	–	–	–	–	–	–
PPHT 12-A2		1.0	10.0	11.4	11.6	11.7	11.8	11.9	12.0	12.0	12.0	–	–	–	–	–	–
PPHT 12-A2		2.0	8.0	10.1	10.4	10.6	10.9	11.0	11.2	11.3	11.5	11.7	11.9	12.0	–	–	–
PPHT 16-A2	16	1.0	14.0	15.4	15.6	15.7	15.8	15.9	16.0	16.0	16.0	–	–	–	–	–	–
PPHT 16-A2		1.3	13.4	15.1	15.3	15.4	15.6	15.7	15.8	15.9	15.9	16.0	–	–	–	–	–
PPHT 16-A2		2.0	12.0	14.1	14.4	14.6	14.9	15.0	15.2	15.3	15.5	15.7	15.9	16.0	–	–	–
PPHT 16-A2		3.0	10.0	12.6	13.0	13.3	13.6	13.9	14.1	14.3	14.5	14.9	15.2	15.7	15.9	16.0	–
PPHT 20-A2	20	1.0	18.0	19.4	19.6	19.7	19.8	19.9	20.0	20.0	20.0	–	–	–	–	–	–
PPHT 20-A2		1.6	16.8	18.7	18.9	19.1	19.3	19.4	19.6	19.7	19.8	19.9	20.0	–	–	–	–
PPHT 20-A2		3.0	14.0	16.6	17.0	17.3	17.6	17.9	18.1	18.3	18.5	18.9	19.2	19.7	19.9	20.0	–
PPHT 20-A2		4.0	12.0	15.0	15.5	15.9	16.2	16.5	16.8	17.1	17.3	17.8	18.2	18.9	19.4	19.7	20.0
PPHT 25-A2	25	2.0	21.0	23.1	23.4	23.6	23.9	24.0	24.2	24.3	24.5	24.7	24.9	25.0	–	–	–
PPHF 08-CE1	8	0.6	2.8	6.0	7.1	–	–	–	–	–	–	–	–	–	–	–	–
PPHF 10-CE1	10	0.8	3.6	6.8	7.9	9.0	–	–	–	–	–	–	–	–	–	–	–
PPHF 12-CE1	12	1.0	4.2	7.4	8.5	9.6	10.7	11.8	–	–	–	–	–	–	–	–	–
PPHF 16-CE1	16	1.3	5.6	8.8	9.9	11.0	12.1	13.2	14.2	15.3	–	–	–	–	–	–	–
PPHF 20-CE1	20	1.6	7.2	10.4	11.5	12.6	13.7	14.8	15.8	16.9	18.0	–	–	–	–	–	–
PPHF 25-CE1	25	1.9	9.2	12.4	13.5	14.6	15.7	16.8	17.8	18.9	20.0	22.7	–	–	–	–	–



		3	5	10	15	20	30	40	50	60	80	100
8		0.310	0.400	0.566	0.693	0.800	0.980	1.131	1.265	1.386	1.600	1.789
10		0.346	0.447	0.632	0.775	0.894	1.095	1.265	1.414	1.549	1.789	2.000
12		0.379	0.490	0.693	0.849	0.980	1.200	1.386	1.549	1.697	1.960	2.191
16		0.438	0.566	0.800	0.980	1.131	1.386	1.600	1.789	1.960	2.263	2.530
20		0.490	0.632	0.894	1.095	1.265	1.549	1.789	2.000	2.191	2.530	2.828
25		0.548	0.707	1.000	1.225	1.414	1.732	2.000	2.236	2.449	2.828	3.162
		3	5	10	15	20	30	40	50	60	80	100
1.3		0.177	0.228	0.322	0.395	0.456	0.559	0.645	0.721	0.790	0.912	1.020
1.6		0.196	0.253	0.358	0.438	0.506	0.620	0.716	0.800	0.876	1.012	1.131
1.9		0.214	0.276	0.390	0.477	0.551	0.675	0.780	0.872	0.955	1.103	1.233
2.0		0.219	0.283	0.400	0.490	0.566	0.693	0.800	0.894	0.980	1.131	1.265
3.0		0.268	0.346	0.490	0.600	0.693	0.849	0.980	1.095	1.200	1.386	1.549
4.0		0.310	0.400	0.566	0.693	0.800	0.980	1.131	1.265	1.386	1.600	1.789



			
PPHT 08-A2	8	0.3	2.4
PPHT 08-A2		0.5	2.4
PPHT 08-A2		0.8	2.5
PPHT 08-A2		1.0	2.7
PPHT 10-A2		0.5	3.2
PPHT 10-A2	10	0.8	3.3
PPHT 10-A2		1.0	3.4
PPHT 12-A2		0.5	4.0
PPHT 12-A2	12	1.0	4.2
PPHT 12-A2		2.0	4.6
PPHT 16-A2		1.0	5.7
PPHT 16-A2	16	1.3	5.8
PPHT 16-A2		2.0	6.0
PPHT 16-A2		3.0	6.4
PPHT 20-A2	20	1.0	7.2
PPHT 20-A2		1.6	7.4
PPHT 20-A2		3.0	7.8
PPHT 20-A2		4.0	8.2
PPHT 25-A2	25	2.0	9.3

			
PPHF 08-CE1	8	0.6	2.0
PPHF 10-CE1	10	0.8	2.5
PPHF 12-CE1	12	1.0	3.0
PPHF 16-CE1	16	1.3	4.0
PPHF 20-CE1	20	1.6	5.0
PPHF 25-CE1	25	1.9	6.0



PPHT 08-A2	8	0.3	6.3	1.2/11
PPHT 08-A2		0.5	6.1	1.2/12
PPHT 08-A2		0.8	5.7	1.2/12
PPHT 08-A2		1.0	6.8	1.2/11
PPHT 10-A2	10	0.5	6.9	1.5/13
PPHT 10-A2		0.8	6.6	1.5/13
PPHT 10-A2		1.0	7.5	1.5/12
PPHT 12-A2	12	0.5	7.9	1.8/13
PPHT 12-A2		1.0	7.5	1.8/14
PPHT 12-A2		2.0	9.0	1.8/12
PPHT 16-A2	16	1.0	8.9	2.4/16
PPHT 16-A2		1.3	8.9	2.4/16
PPHT 16-A2		2.0	8.5	2.4/17
PPHT 16-A2		3.0	12.3	2.4/11
PPHT 20-A2	20	1.0	9.3	3/19
PPHT 20-A2		1.6	9.1	3/19
PPHT 20-A2		3.0	8.8	3/20
PPHT 20-A2		4.0	11.4	3/15
PPHT 25-A2	25	2.0	8.3	3.7/26

PPHF 08-CE1	8	0.6	8.0	0.4/3
PPHF 10-CE1	10	0.8	8.0	0.5/4
PPHF 12-CE1	12	1.0	8.0	0.6/5
PPHF 16-CE1	16	1.3	8.0	0.8/6
PPHF 20-CE1	20	1.6	8.0	1.0/8
PPHF 25-CE1	25	1.9	8.0	1.2/9



			DMIN	DMAX		
					DMIN	DMAX
PPHT 08-A2	8	0.3	11.0	15.9	0.5	0.5
PPHT 08-A2		0.5	10.9	15.9	0.5	0.5
PPHT 08-A2		0.8	10.7	15.9	0.4	0.4
PPHT 08-A2		1.0	10.3	15.9	0.4	0.4
PPHT 10-A2	10	0.5	13.4	19.9	0.7	0.7
PPHT 10-A2		0.8	13.2	19.9	0.6	0.6
PPHT 10-A2		1.0	12.9	19.9	0.6	0.6
PPHT 12-A2	12	0.5	15.8	23.9	1.0	1.0
PPHT 12-A2		1.0	15.4	23.9	0.8	0.8
PPHT 12-A2		2.0	14.6	23.9	0.7	0.7
PPHT 16-A2	16	1.0	20.4	31.9	1.3	1.3
PPHT 16-A2		1.3	20.2	31.9	1.3	1.3
PPHT 16-A2		2.0	19.7	31.9	1.0	1.0
PPHT 16-A2		3.0	18.9	31.9	1.2	1.2
PPHT 20-A2	20	1.0	25.4	39.9	1.8	1.8
PPHT 20-A2		1.6	24.9	39.9	1.6	1.6
PPHT 20-A2		3.0	24.1	39.9	1.2	1.2
PPHT 20-A2		4.0	23.3	39.9	1.3	1.3
PPHT 25-A2	25	2.0	31.1	49.9	1.8	1.8

			DMIN	DMAX		
					DMIN	DMAX
PPHF 08-CE1	8	0.6	10.0	14.7	0.40	0.40
PPHF 10-CE1	10	0.8	13.0	18.4	0.50	0.50
PPHF 12-CE1	12	1.0	15.7	22.0	0.60	0.60
PPHF 16-CE1	16	1.3	20.9	29.4	0.80	0.80
PPHF 20-CE1	20	1.6	26.2	36.7	1.00	1.00
PPHF 25-CE1	25	1.9	33.0	46.1	1.20	1.20



PPHT 08-A2	8	0.3	0.52
PPHT 08-A2		0.5	0.47
PPHT 08-A2		0.8	0.39
PPHT 08-A2		1.0	0.40
PPHT 10-A2		10	0.5
PPHT 10-A2	0.8		0.61
PPHT 10-A2	1.0		0.62
PPHT 12-A2	12	0.5	0.97
PPHT 12-A2		1.0	0.79
PPHT 12-A2		2.0	0.68
PPHT 16-A2	16	1.0	1.33
PPHT 16-A2		1.3	1.26
PPHT 16-A2		2.0	1.03
PPHT 16-A2		3.0	1.15
PPHT 20-A2	20	1.0	1.80
PPHT 20-A2		1.6	1.59
PPHT 20-A2		3.0	1.21
PPHT 20-A2		4.0	1.27
PPHT 25-A2	25	2.0	1.83

PPHF 08-CE1	8	0.6	0.40
PPHF 10-CE1	10	0.8	0.50
PPHF 12-CE1	12	1.0	0.60
PPHF 16-CE1	16	1.3	0.80
PPHF 20-CE1	20	1.6	1.00
PPHF 25-CE1	25	1.9	1.20

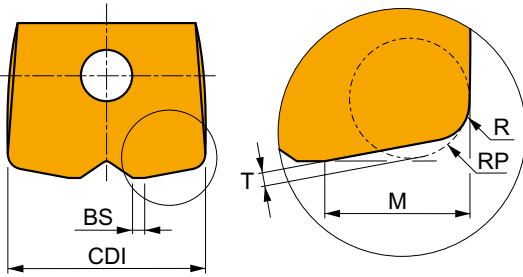

	R	RP	M	T
08	0.6	1.0	2.6	0.3
10	0.8	1.2	3.2	0.4
12	1.0	1.5	3.9	0.4
16	1.3	2.0	5.2	0.6
20	1.6	2.5	6.4	0.7
25	1.9	3.0	7.9	0.9



Overhang (multiple of diameter DCX)	<3.0	3.0 – 3.5	3.6 – 4.0	4.1 – 4.5	>4.6
Multiplication factor for speed	1.0	0.9	0.8	0.7	0.5

SVC22C

N

PRAMET

S



Milling Cutters for Machining Non ferrous materials with Internal Coolant

Highly productive cutter for aluminium and non ferrous material utilising VCGT 22 inserts with APMX of 16 mm. Internal coolant. Suitable for face, progressive plunge, shoulder, ramping and slot milling. Available in cylindrical, modular and arbor style, in range of Ø32 up to Ø80 mm. Body treated for longer tool life.

KAPR	90°
APMX	3.0 (16.0) mm

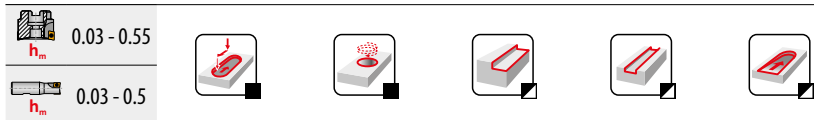
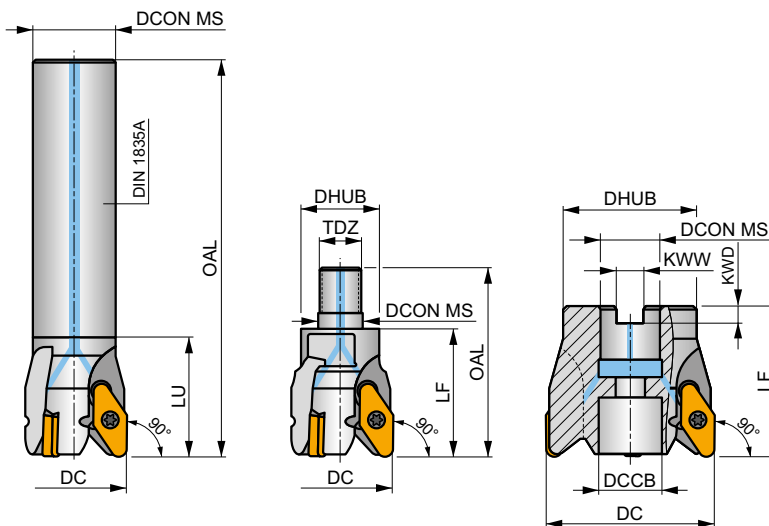
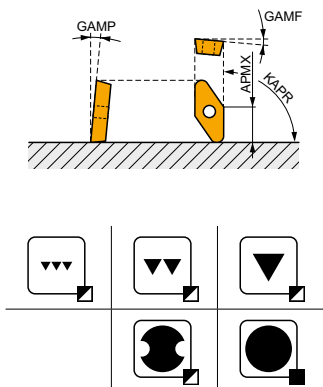

Product	DC	OAL	DCON MS	DCCB	LU	LF	DHUB	TDZ	KWW	KWD	GAMF	GAMP	max.		kg	C0560		
	[mm]	[mm]	[mm]	[mm]	[mm]	[mm]	[mm]	[mm]	[mm]	[mm]	[°]	[°]						
32A2R045A25-SVC22C	32	120	25	-	45	-	-	-	-	-	4	3	2	-	10400	✓	0.46	GI141 C0560
40A3R045A32-SVC22C	40	150	32	-	45	-	-	-	-	-	8	3	3	-	9300	✓	0.91	GI141 C0560
32A2R048M16-SVC22C	32	71	17	-	-	48	29	M16	-	-	11	3	2	-	-	✓	0.23	GI141 C0560
40A3R048M16-SVC22C	40	71	17	-	-	48	29	M16	-	-	13	3	3	-	-	✓	0.26	GI141 C0560
50A03R-S90VC22C	50	-	22	18	-	56	40	-	10	6.3	4	3	3	-	8400	✓	0.44	GI141 C0563
63A04R-S90VC22C	63	-	22	18	-	56	50	-	10	6.3	6	3	4	-	7400	✓	0.68	GI141 C0563
80A05R-S90VC22C	80	-	27	20	-	56	63	-	12	7	8	3	5	-	6600	✓	1.15	GI141 C0562

	GI141		VCGT 220530F-FA
--	-------	--	-----------------

C0560	US 4511-T20	5.0	M 4.5	11	-	-	Flag T20
C0562	US 4511-T20	5.0	M 4.5	11	SDR T20-T	-	-
C0563	US 4511-T20	5.0	M 4.5	11	SDR T20-T	HS 1030C	-



VCGT 22-FA

	IC	D1	L	S
	[mm]	[mm]	[mm]	[mm]
2205	12.700	5.20	22.00	5.50

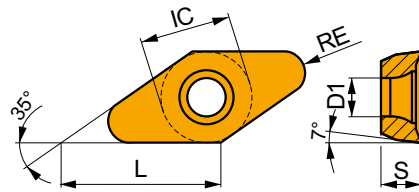

Suitability and starting values for cutting speed (vc), feed (f) and depth of cut (ap). Refer to our Machining Calculator app for further calculations.

Product	RE [mm]	P			M			K			N			S			H		
		vc [m/min]	f [mm/tooth]	ap [mm]	vc [m/min]	f [mm/tooth]	ap [mm]	vc [m/min]	f [mm/tooth]	ap [mm]	vc [m/min]	f [mm/tooth]	ap [mm]	vc [m/min]	f [mm/tooth]	ap [mm]	vc [m/min]	f [mm/tooth]	ap [mm]

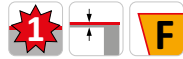
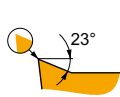

FA geometry with highly positive design for medium to rough machining.

VCGT 220530F-FA	HF7	3.0	-	-	-	-	-	-	-	210	0.48	1.0	-	-	-	-	-	-
-----------------	-----	-----	---	---	---	---	---	---	---	-----	------	-----	---	---	---	---	---	---



a_e / DC	5 %	10 %	15 %	20 %	25 %	30 %	40 %	50 %	60 %	70 %	75 %	80 %	90 %	100 %
	1.48	1.35	1.27	1.22	1.19	1.16	1.11	1.08	1.05	1.03	1.00	1.00	1.00	1.00
	2.20	1.60	1.35	1.20	1.10	0.95	0.85	0.75	0.85	0.95	1.00	1.00	1.00	1.00
	0.64	0.64	0.64	0.64	0.64	0.65	0.65	0.67	0.68	0.71	0.72	0.74	0.79	1.00

	VCGT 22-FA
	3.0
	-

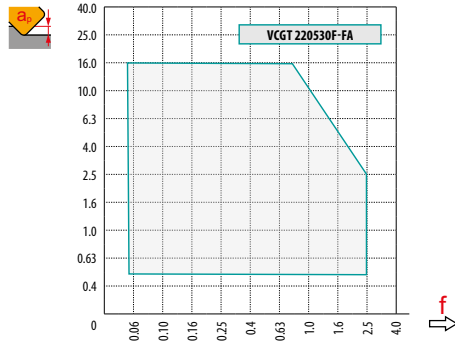

	0.5	3.0	12.0
	0.86	0.31	0.05

	RPMX	APMX/I
32	8.0	12.0/87
40	8.0	12.0/87
50	6.0	10.4/100
63	4.2	7.2/100
80	3.1	5.3/100

	DMIN	DMAX		
32	42.0	64.0	4.2	12.0
40	58.0	80.0	7.7	12.0
50	78.0	100.0	9.0	12.0
63	104.0	126.0	9.3	12.0
80	138.0	160.0	9.7	12.0

	9

		3	5	10	15	20	30	40	50	60	80	100
32		0.620	0.800	1.131	1.386	1.600	1.960	2.263	2.530	2.771	3.200	3.578
40		0.693	0.894	1.265	1.549	1.789	2.191	2.530	2.828	3.098	3.578	4.000
50		0.775	1.000	1.414	1.732	2.000	2.449	2.828	3.162	3.464	4.000	4.472
63		0.869	1.122	1.587	1.944	2.245	2.750	3.175	3.550	3.888	4.490	5.020
80		0.980	1.265	1.789	2.191	2.530	3.098	3.578	4.000	4.382	5.060	5.657
		3	5	10	15	20	30	40	50	60	80	100
3.0		0.268	0.346	0.490	0.600	0.693	0.849	0.980	1.095	1.200	1.386	1.549



SWN04C



End Mills for Die & Mold Applications with Internal Coolant

End mill for a wide range of applications in the finishing area for Die & Mold with APMX of 0.5 mm. High precision ground WNHX 04 inserts with 6 cutting edges, provide high accuracy and economy. Available in cylindrical and modular style, in range Ø20 up to Ø35 mm. Body treated for longer tool life.

KAPR	90° (93°)
APMX	0.5 (2.0 mm)

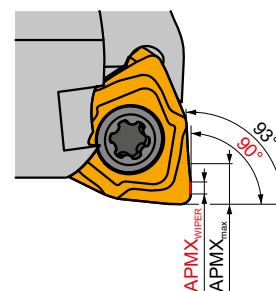
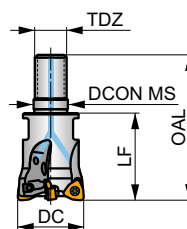
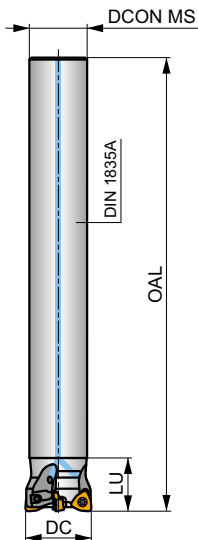
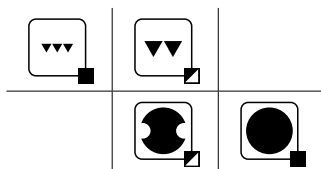
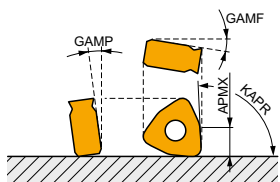

h_m 0.02 - 0.07



Product	DC	OAL	DCON MS	LU	LF	TDZ	GAMF	GAMP	GAMF	GAMP	max.	kg	G1331	C0602	
															[mm]
20A3R020A18-SWN04C-C	20	160	18	20	-	-	-12	-8	3	-	19700	-	0.27	G1331	C0602
25A4R020A22-SWN04C-C	25	180	22	20	-	-	-11.5	-8	4	-	26600	-	0.45	G1331	C0602
32A6R020A25-SWN04C-C	32	200	25	20	-	-	-11.2	-8	6	-	23500	-	0.69	G1331	C0602
20A3R030M10-SWN04C-C	20	49	10.5	-	30	M10	-12	-8	3	-	-	-	0.08	G1331	C0602
25A4R033M12-SWN04C-C	25	55	12.5	-	33	M12	-11.5	-8	4	-	-	-	0.11	G1331	C0602
32A6R040M16-SWN04C-C	32	63	17	-	40	M16	-11.2	-8	6	-	-	-	0.19	G1331	C0602
35A6R043M16-SWN04C-C	35	66	17	-	43	M16	-11.1	-8	6	-	-	-	0.22	G1331	C0602



G1331



WNHX0403..



C0602



US 42507-T07P



1.2



M 2.5



7



Flag T07P



WNHX 04



	IC	D1	S
	[mm]	[mm]	[mm]
0403	6.200	2.60	3.38

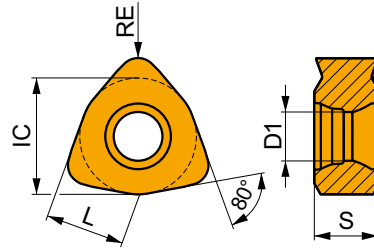

Suitability and starting values for cutting speed (vc), feed (f) and depth of cut (ap). Refer to our Machining Calculator app for further calculations.

Product	RE [mm]	P			M			K			N			S			H		
		vc [m/min]	f [mm/tooth]	ap [mm]	vc [m/min]	f [mm/tooth]	ap [mm]	vc [m/min]	f [mm/tooth]	ap [mm]	vc [m/min]	f [mm/tooth]	ap [mm]	vc [m/min]	f [mm/tooth]	ap [mm]	vc [m/min]	f [mm/tooth]	ap [mm]

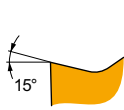
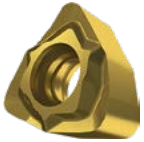

WM geometry with wiper design for semi-finish to finish machining.

WNHX 040305ER-WM	M4310	0.5	290	0.15	1.0	-	-	-	275	0.15	1.0	-	-	-	-	-	-	55	0.15	1.0
	M8330	0.5	260	0.15	1.0	-	-	-	245	0.15	1.0	-	-	-	-	-	-	50	0.15	1.0
WNHX 040310ER-WM	M4310	1.0	370	0.15	1.0	-	-	-	350	0.15	1.0	-	-	-	-	-	-	70	0.15	1.0
	M8330	1.0	330	0.15	1.0	-	-	-	310	0.15	1.0	-	-	-	-	-	-	65	0.15	1.0
WNHX 040315ER-WM	M4310	1.5	390	0.15	1.0	-	-	-	370	0.15	1.0	-	-	-	-	-	-	75	0.15	1.0
	M8330	1.5	345	0.15	1.0	-	-	-	325	0.15	1.0	-	-	-	-	-	-	65	0.15	1.0



a_s DC	5 %	10 %	15 %	20 %	25 %	30 %	40 %	50 %	60 %	70 %	75 %	80 %	90 %	100 %
$X.V$	1.48	1.35	1.27	1.22	1.19	1.16	1.11	1.08	1.05	1.03	1.00	1.00	1.00	1.00



a_s DC	0.5 %	1.0 %	2.0 %	3.0 %	4.0 %	5.0 %
$X.V$	2.04	1.85	1.68	1.59	1.53	1.48



WNHX 04-WM

RE	0.5	1.0	1.5
BS	0.50	0.50	0.50

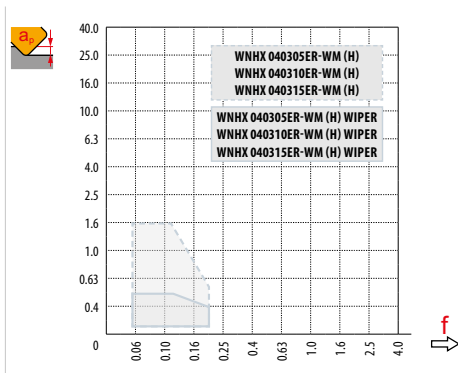
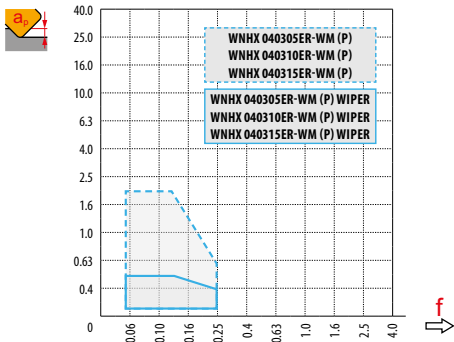

DC	max
20	0.4
25	0.5
32	0.5
35	0.5



DC	RPMX	APMX/I
20	0.7	1.1/100
25	0.5	0.75/100
32	0.3	0.4/100
35	0.3	0.4/100



SCN05C



PRAMET

S



End Mills for Die & Mold Applications with Internal Coolant

End mill for a wide range of applications in the finishing area for Die & Mold with APMX of 0.5 mm. High precision ground double-sided CNHX 05 inserts with 4 cutting edges provide high accuracy and economy. Available in cylindrical and modular style, in range Ø12 up to Ø20 mm. Body treated for longer tool life.

KAPR	90° (93°)
APMX	0.5 (1.0 mm)

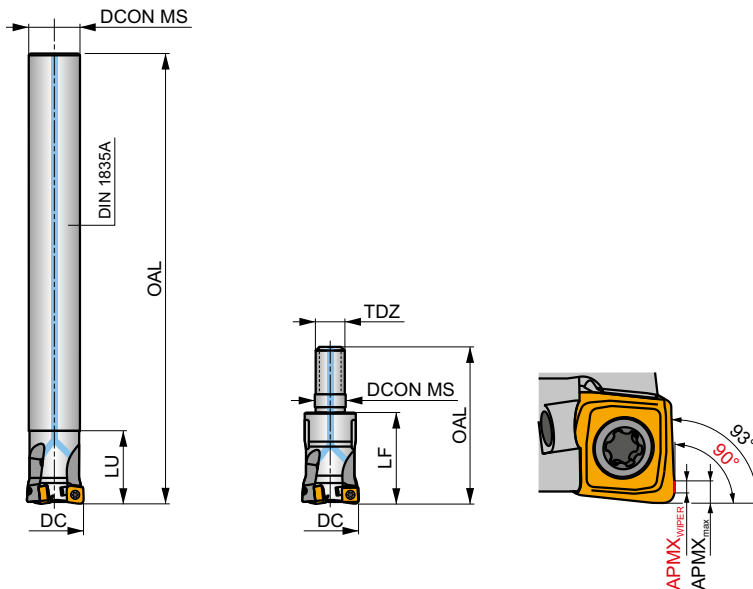
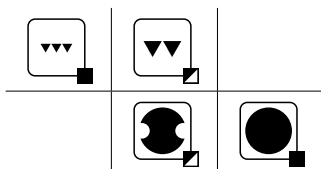
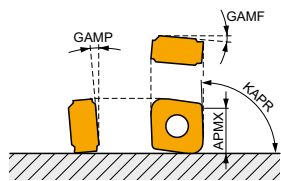

h_m 0.02 - 0.07



Product	DC [mm]	OAL [mm]	DCON MS [mm]	LU [mm]	LF [mm]	TDZ	GAMF [°]	GAMP [°]	Icons	max.	kg	GI330	C0601		
12A2R020A10-SCN05C-C	12	100	10	20	-	-	-15	-8	2	-	48700	✓	0.08	GI330	C0601
16A3R020A14-SCN05C-C	16	130	14	20	-	-	-13.5	-7.8	3	-	42200	✓	0.13	GI330	C0601
20A5R020A18-SCN05C-C	20	160	18	20	-	-	-12.7	-7.5	5	✓	37700	✓	0.28	GI330	C0601
12A2R020M06-SCN05C-C	12	35	6.5	-	20	M6	-15	-8	2	-	-	✓	0.04	GI330	C0601
16A3R025M08-SCN05C-C	16	43	8.5	-	25	M8	-13.5	-7.8	3	-	-	✓	0.06	GI330	C0601
20A5R030M10-SCN05C-C	20	49	10.5	-	30	M10	-12.7	-7.5	5	✓	-	✓	0.08	GI330	C0601

	GI330		CNHX0502..
--	-------	--	------------

	C0601		US 62005-T06P		0.9		M 2		4.9		Flag T06P
--	-------	--	---------------	--	-----	--	-----	--	-----	--	-----------



CNHX 05

	IC	D1	S
	[mm]	[mm]	[mm]
0502	4.800	2.10	2.40

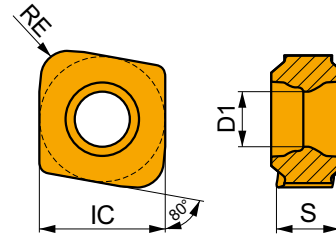

Suitability and starting values for cutting speed (vc), feed (f) and depth of cut (ap). Refer to our Machining Calculator app for further calculations.

Product	RE [mm]	P			M			K			N			S			H		
		vc [m/min]	f [mm/tooth]	ap [mm]	vc [m/min]	f [mm/tooth]	ap [mm]	vc [m/min]	f [mm/tooth]	ap [mm]	vc [m/min]	f [mm/tooth]	ap [mm]	vc [m/min]	f [mm/tooth]	ap [mm]	vc [m/min]	f [mm/tooth]	ap [mm]

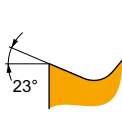

WM geometry with wiper design for semi-finish to finish machining.

CNHX 050205ER-WM	M4310	0.5	350	0.10	0.5	–	–	–	335	0.10	0.5	–	–	–	–	–	–	–	70	0.15	1.0
	M8330	0.5	310	0.10	0.5	–	–	–	290	0.10	0.5	–	–	–	–	–	–	–	60	0.15	1.0
CNHX 050210ER-WM	M4310	1.0	440	0.10	0.5	–	–	–	420	0.10	0.5	–	–	–	–	–	–	–	85	0.15	1.0
	M8330	1.0	390	0.10	0.5	–	–	–	370	0.10	0.5	–	–	–	–	–	–	–	75	0.15	1.0



$\frac{a_e}{DC}$	5 %	10 %	15 %	20 %	25 %	30 %	40 %	50 %	60 %	70 %	75 %	80 %	90 %	100 %
$\frac{X.V}{\text{REV}}$	1.48	1.35	1.27	1.22	1.19	1.16	1.11	1.08	1.05	1.03	1.00	1.00	1.00	1.00



$\frac{a_e}{DC}$	0.5 %	1.0 %	2.0 %	3.0 %	4.0 %	5.0 %
$\frac{X.V}{\text{REV}}$	2.04	1.85	1.68	1.59	1.53	1.48



CNHX 05-WM

RE	0.5	1.0
BS	0.50	0.50

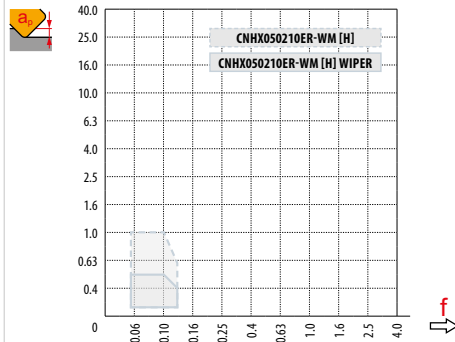
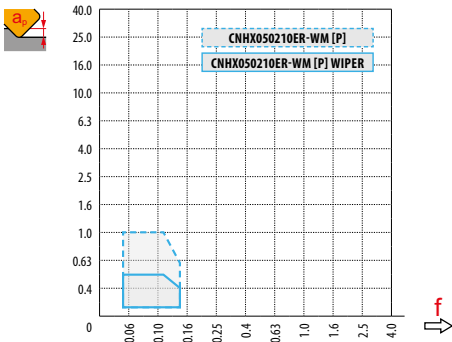

$\frac{DC}{\text{REV}}$	max
12	0.4
16	0.4
20	0.5



$\frac{DC}{\text{REV}}$	RPMX	APMX/I
12	2.4	1/25
16	1.5	1/40
20	1.1	1/54





























INDEXABLE HIGH FEED MILLS



INDEXABLE HIGH FEED MILLS – NAVIGATOR

HIGH FEED MILLING















	SBN10		SSN11		SPD09		SZD07		SZD09							
	20°		18°		19°		-		-							
	APMX [mm]	1.0	APMX [mm]	1.7	APMX [mm]	2.0	APMX [mm]	1.0	APMX [mm]	1.0						
	DCX [mm]	16 – 42	DCX [mm]	32 – 125	DCX [mm]	32 – 140	DCX [mm]	16 – 32	DCX [mm]	25 – 66						
Cylindrical shank		DCX = 16 – 35 [mm]		DCX = 32 – 35 [mm]		DCX = 32 – 40 [mm]		DCX = 16 – 25 [mm]								
Weldon										DCX = 25 – 32 [mm]						
Modular		DCX = 16 – 40 [mm]		DCX = 32 – 40 [mm]				DCX = 16 – 32 [mm]		DCX = 25 – 42 [mm]						
Shell mill		DCX = 40 – 42 [mm]		DCX = 40 – 125 [mm]		DCX = 42 – 140 [mm]				DCX = 40 – 66 [mm]						
Page	616		622		627		633		637							
ISO	P	M	K	S	H	P	M	K	S	H	P	K	H	P	K	H
Insert shape																
Inserts	BNGX 10T3 ANHX 10T3		SNGX 1104		PD.. 0905		ZDCW 0703		ZDCW 09T3							
No. of cutting edges	4/2		8		5		4		4							
Face milling 	■		■		■		■		■							
Helical interpolation 	■		▣		■		▣		▣							
Shallow shoulder milling 	■		■		■		▣		▣							
Plunge milling 	■		■		■		▣		▣							
Progressive plunging 	■		▣		■		▣		▣							
Ramping 	■		▣		■											
Shape surfaces milling (copy milling) 	■		■		▣		▣		▣							
Shallow slot milling 	▣		▣		▣		▣		▣							



INDEXABLE HIGH FEED MILLS – NAVIGATOR



HIGH FEED MILLING

SZD12									
-									
APMX [mm]	1.6								
DCX [mm]	32 – 80								
	DCX = 40 [mm]								
	DCX = 32 – 40 [mm]								
	DCX = 50 – 80 [mm]								
	641								
P	K	H							
									
ZDEW 1204									
4									
	<input type="checkbox"/>								
	<input checked="" type="checkbox"/>								
	<input checked="" type="checkbox"/>								
	<input checked="" type="checkbox"/>								
	<input checked="" type="checkbox"/>								
									
	<input checked="" type="checkbox"/>								
	<input checked="" type="checkbox"/>								



SBN10

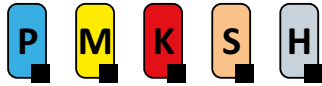

PRAMET

S



High Feed Milling Cutter for BN.. 10 inserts with Internal Coolant, Next Generation

High-feed milling cutter for smaller diameters utilising double-sided BNGX 10 inserts with four cutting edges and APMX of 1 mm. Internal coolant. Suitable for a wide range of applications. Available in cylindrical, modular and arbor style in range of Ø16 up to Ø42 mm. Body treated for longer tool life.

KAPR	20°
APMX	1.0 mm

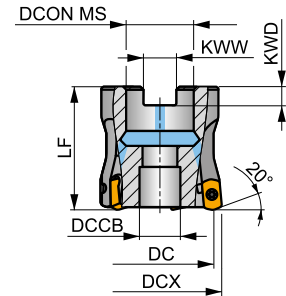
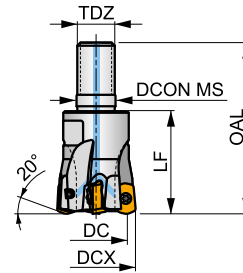
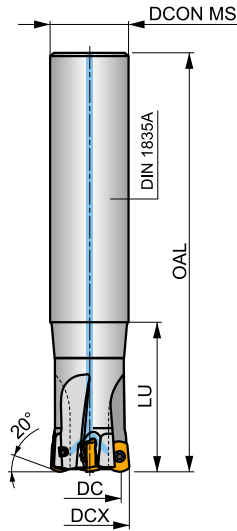
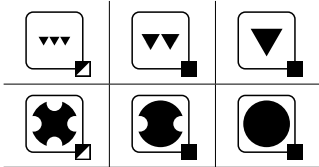
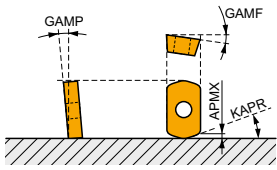

	0.17 - 0.41
	0.17 - 0.41



Product	DCX	DC	OAL	DCON MS	DCCB	LU	LF	TDZ	KWW	KWD	GAMF	GAMP	max.		kg	G329	C0310		
	[mm]	[mm]	[mm]	[mm]	[mm]	[mm]	[mm]	[mm]	[mm]	[mm]	[°]	[°]	max.	max.					
16E2R030A16-SBN10-C	16	9.4	100	16	-	30	-	-	-	-	-12	-10	2	✓	31100	✓	0.13	G329	C0310
16E2R050A16-SBN10-C	16	9.4	150	16	-	50	-	-	-	-	-12	-10	2	-	31100	✓	0.18	G329	C0310
16E2R030A14-SBN10-C	16	9.4	150	14	-	30	-	-	-	-	-12	-10	2	-	31100	✓	0.15	G329	C0310
18E2R030A16-SBN10-C	18	11.4	150	16	-	30	-	-	-	-	-11	-10	2	-	29200	✓	0.20	G329	C0310
20E3R040A20-SBN10-C	20	13.4	130	20	-	40	-	-	-	-	-10	-10	3	-	27700	✓	0.25	G329	C0310
20E3R080A20-SBN10-C	20	13.4	160	20	-	80	-	-	-	-	-10	-10	3	-	27700	✓	0.29	G329	C0310
20E3R040A18-SBN10-C	20	13.4	180	18	-	40	-	-	-	-	-10	-10	3	-	27700	✓	0.30	G329	C0310
20E4R040A20-SBN10-C	20	13.4	130	20	-	40	-	-	-	-	-10	-10	4	-	27700	✓	0.26	G329	C0310
25E4R050A25-SBN10-C	25	18.4	140	25	-	50	-	-	-	-	-9	-10	4	✓	24800	✓	0.42	G329	C0310
25E4R100A25-SBN10-C	25	18.4	180	25	-	100	-	-	-	-	-9	-10	4	✓	24800	✓	0.51	G329	C0310
25E4R050A22-SBN10-C	25	18.4	220	22	-	50	-	-	-	-	-9	-10	4	✓	24800	✓	0.54	G329	C0310
25E5R050A25-SBN10-C	25	18.4	140	25	-	50	-	-	-	-	-9	-10	5	-	24800	✓	0.42	G329	C0310
32E5R070A32-SBN10-C	32	25.4	150	32	-	70	-	-	-	-	-8	-10	5	✓	21900	✓	0.73	G329	C0310
32E6R070A32-SBN10-C	32	25.4	150	32	-	70	-	-	-	-	-8	-10	6	✓	21900	✓	0.73	G329	C0310
32E5R120A32-SBN10-C	32	25.4	200	32	-	120	-	-	-	-	-8	-10	5	✓	21900	✓	1.02	G329	C0310
35E5R050A32-SBN10-C	35	28.4	200	32	-	50	-	-	-	-	-7.5	-10	5	✓	21000	✓	1.08	G329	C0310
35E6R050A32-SBN10-C	35	28.4	200	32	-	50	-	-	-	-	-7.5	-10	6	✓	21000	✓	1.08	G329	C0310
16E2R025M08-SBN10-C	16	9.4	43	8.5	-	25	M8	-	-	-	-12	-10	2	-	31100	✓	0.03	G329	C0310
18E2R025M08-SBN10-C	18	11.4	43	8.5	-	25	M8	-	-	-	-11	-10	2	-	29200	✓	0.06	G329	C0310
20E3R030M10-SBN10-C	20	13.4	49	10.5	-	30	M10	-	-	-	-10	-10	3	-	27700	✓	0.08	G329	C0310
20E4R030M10-SBN10-C	20	13.4	49	10.5	-	30	M10	-	-	-	-10	-10	4	-	27700	✓	0.08	G329	C0310
25E4R033M12-SBN10-C	25	18.4	55	12.5	-	33	M12	-	-	-	-9	-10	4	✓	24800	✓	0.08	G329	C0310
25E5R033M12-SBN10-C	25	18.4	55	12.5	-	33	M12	-	-	-	-9	-10	5	-	24800	✓	0.10	G329	C0310
28E5R035M12-SBN10-C	28	21.4	57	12.5	-	35	M12	-	-	-	-8.5	-10	5	✓	23400	✓	0.13	G329	C0310
32E5R040M16-SBN10-C	32	25.4	63	17	-	40	M16	-	-	-	-8	-10	5	✓	21900	✓	0.21	G329	C0310
32E6R040M16-SBN10-C	32	25.4	63	17	-	40	M16	-	-	-	-8	-10	6	✓	21900	✓	0.21	G329	C0310
35E6R043M16-SBN10-C	35	28.4	66	17	-	43	M16	-	-	-	-7.5	-10	6	✓	21000	✓	0.24	G329	C0310



Product	DCX	DC	OAL	D CON MS	DCB	LU	LF	TDZ	KWW	KWD	GAMF	GAMP	max.		kg	G329	C0310	
	[mm]	[mm]	[mm]	[mm]	[mm]	[mm]	[mm]	[mm]	[mm]	[mm]	[°]	[°]						
40E6R043M16-SBN10-C	40	33.4	66	17	-	-	43	M16	-	-	-7	-10	6	✓	19600	✓	0.27	G329 C0310
40E7R043M16-SBN10-C	40	33.4	66	17	-	-	43	M16	-	-	-7	-10	7	✓	19600	✓	0.26	G329 C0310
40A05R-SMOBN10-C	40	33.4	-	16	14.1	-	40	-	8.4	5.6	-7	-10	5	✓	19600	✓	0.23	G329 C0312
40A07R-SMOBN10-C	40	33.4	-	16	14.1	-	40	-	8.4	5.6	-7	-10	7	✓	19600	✓	0.27	G329 C0312
42A05R-SMOBN10-C	42	35.4	-	16	14.1	-	40	-	8.4	5.6	-7	-10	5	✓	19100	✓	0.23	G329 C0312
42A07R-SMOBN10-C	42	35.4	-	16	14.1	-	40	-	8.4	5.6	-7	-10	7	✓	19100	✓	0.26	G329 C0312

G329	BNGX 10T3...	ANHX 10T3..

C0310	US 42507-T07P	3.0	M 2.5	7	Flag T07P	-	-
C0312	US 42507-T07P	3.0	M 2.5	7	D-T07P/T09P	FG-15	HS 0830C

BNGX 10



	W1	D1	L	S
	[mm]	[mm]	[mm]	[mm]
10T3	5.800	2.76	9.92	3.90

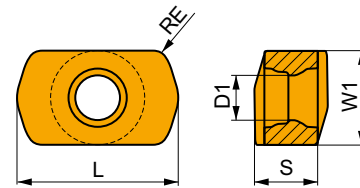

Suitability and starting values for cutting speed (vc), feed (f) and depth of cut (ap). Refer to our Machining Calculator app for further calculations.

Product	RE	P			M			K			N			S			H		
		vc	f	ap	vc	f	ap	vc	f	ap	vc	f	ap	vc	f	ap	vc	f	ap
	[mm]	[m/min]	[mm/tooth]	[mm]	[m/min]	[mm/tooth]	[mm]	[m/min]	[mm/tooth]	[mm]	[m/min]	[mm/tooth]	[mm]	[m/min]	[mm/tooth]	[mm]	[m/min]	[mm/tooth]	[mm]



M geometry with positive design for high feed machining.

BNGX 10T308SR-M	8215	0.8	■	240	0.65	0.7	■	-	-	-	■	225	0.65	0.7	■	-	-	-	■	45	0.15	1.0
	M6330	0.8	■	210	0.65	0.7	■	-	-	-	■	-	-	-	■	-	-	-	■	-	-	-
	M8310	0.8	■	250	0.65	0.7	■	-	-	-	■	235	0.65	0.7	■	-	-	-	■	50	0.15	1.0
	M8330	0.8	■	240	0.65	0.7	■	-	-	-	■	225	0.65	0.7	■	-	-	-	■	45	0.15	1.0
	M8340	0.8	■	225	0.65	0.7	■	-	-	-	■	210	0.65	0.7	■	-	-	-	■	-	-	-
	M8345	0.8	■	180	0.65	0.7	■	-	-	-	■	-	-	-	■	-	-	-	■	-	-	-
	M9325	0.8	■	275	0.65	0.7	■	-	-	-	■	260	0.65	0.7	■	-	-	-	■	55	0.15	1.0



Suitability and starting values for cutting speed (vc), feed (f) and depth of cut (ap). Refer to our Machining Calculator app for further calculations.

Product	RE [mm]	P			M			K			N			S			H		
		vc [m/min]	f [mm/tooth]	ap [mm]	vc [m/min]	f [mm/tooth]	ap [mm]	vc [m/min]	f [mm/tooth]	ap [mm]	vc [m/min]	f [mm/tooth]	ap [mm]	vc [m/min]	f [mm/tooth]	ap [mm]	vc [m/min]	f [mm/tooth]	ap [mm]

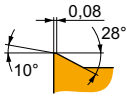

MM geometry with highly positive design for high feed machining.

BNGX 10T308SR-MM	M6330	0.8	215	0.65	0.6	150	0.59	0.6	–	–	–	–	–	–	60	0.46	0.5	–	–	–	
	M8310	0.8	255	0.65	0.6	130	0.59	0.6	–	–	–	–	–	–	–	–	–	–	–	–	
	M8330	0.8	245	0.65	0.6	145	0.59	0.6	–	–	–	–	–	–	60	0.46	0.5	–	–	–	
	M8340	0.8	230	0.65	0.6	135	0.59	0.6	–	–	–	–	–	–	55	0.46	0.5	–	–	–	
	M8345	0.8	180	0.65	0.6	105	0.59	0.6	–	–	–	–	–	–	45	0.46	0.5	–	–	–	
	M9325	0.8	280	0.65	0.6	–	–	–	–	–	–	–	–	–	–	–	–	–	–	–	–
	M9340	0.8	250	0.65	0.6	150	0.59	0.6	–	–	–	–	–	–	60	0.46	0.5	–	–	–	

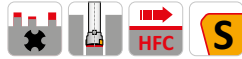
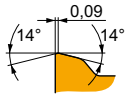

HM geometry with strong design for high feed machining.

BNGX 10T308SR-HM	8215	0.8	–	–	–	290	0.30	0.4	–	–	–	–	–	–	60	0.15	1.0	–	–	–
	M8310	0.8	–	–	–	305	0.30	0.4	–	–	–	–	–	–	65	0.15	1.0	–	–	–
	M8330	0.8	–	–	–	285	0.30	0.4	–	–	–	–	–	–	60	0.15	1.0	–	–	–

ANHX 10



	W1	D1	L	S
	[mm]	[mm]	[mm]	[mm]
10T3	5.800	2.76	9.72	4.70

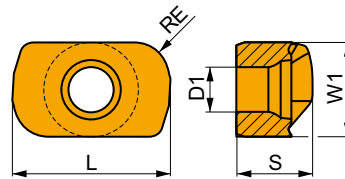

Suitability and starting values for cutting speed (vc), feed (f) and depth of cut (ap). Refer to our Machining Calculator app for further calculations.

Product	RE [mm]	P			M			K			N			S			H		
		vc [m/min]	f [mm/tooth]	ap [mm]	vc [m/min]	f [mm/tooth]	ap [mm]	vc [m/min]	f [mm/tooth]	ap [mm]	vc [m/min]	f [mm/tooth]	ap [mm]	vc [m/min]	f [mm/tooth]	ap [mm]	vc [m/min]	f [mm/tooth]	ap [mm]

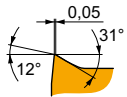

F geometry with positive design for finish and semi-finish machining.

ANHX 10T320SR-F	M8310	2.0	380	0.10	2.5	190	0.09	2.5	–	–	–	–	–	–	–	–	–	–	–	–
	M8330	2.0	340	0.10	2.5	200	0.09	2.5	–	–	–	–	–	–	–	–	–	–	–	–



a_e DCX	5 %	10 %	15 %	20 %	25 %	30 %	40 %	50 %	60 %	70 %	75 %	80 %	90 %	100 %
	1.48	1.35	1.27	1.22	1.19	1.16	1.11	1.08	1.05	1.03	1.00	1.00	1.00	1.00
	2.20	1.60	1.35	1.20	1.10	0.95	0.85	0.75	0.85	0.95	1.00	1.00	1.00	1.00
	0.64	0.64	0.64	0.64	0.64	0.65	0.65	0.67	0.68	0.71	0.72	0.74	0.79	1.00

	BNGX 10-M	BNGX 10-MM	BNGX 10-HM		ANHX 10-F
	0.8	0.8	0.8		2.0
	-	-	-		0.92

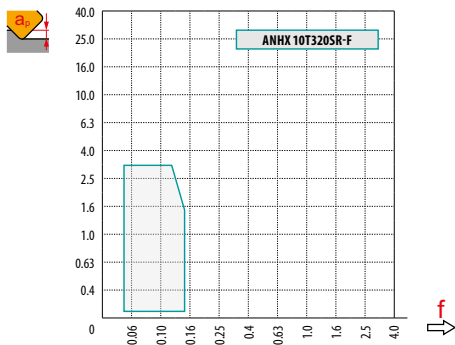
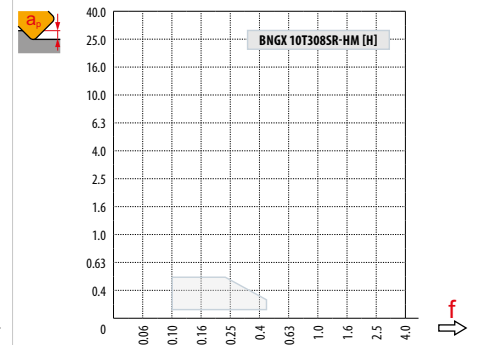
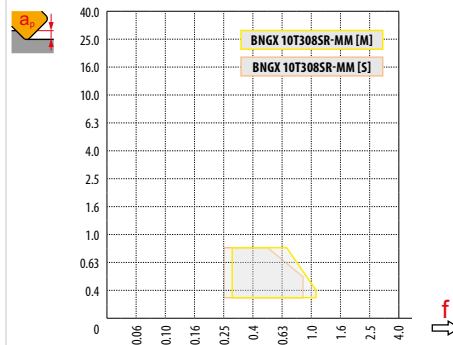
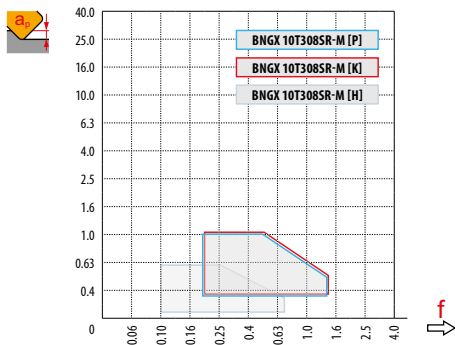



BNGX 10 (HFC)

		0.00	0.30	0.40	0.50	0.60	0.70	0.80	0.90	1.00
16		9.40	12.85	13.36	13.80	14.20	14.56	14.88	15.19	15.47
18		11.40	14.85	15.36	15.80	16.20	16.56	16.88	17.19	17.47
20		13.40	16.85	17.36	17.80	18.20	18.56	18.88	19.19	19.47
25		18.40	21.85	22.36	22.80	23.20	23.56	23.88	24.19	24.47
28		21.40	24.85	25.36	25.80	26.20	26.56	26.88	27.19	27.47
32		25.40	28.85	29.36	29.80	30.20	30.56	30.88	31.19	31.47
35		28.40	31.85	32.36	32.80	33.20	33.56	33.88	34.19	34.47
40		33.40	36.85	37.36	37.80	38.20	38.56	38.88	39.19	39.47
42		35.40	38.85	39.36	39.80	40.20	40.56	40.88	41.19	41.47
		0.00	0.30	0.40	0.50	0.60	0.70	0.80	0.90	1.00
		-	1.30	1.10	0.90	0.80	0.72	0.68	0.65	0.50



BNGX 10

		f_{max}
16	3.5	0.12
18	3.5	0.12
20	4.0	0.15
25	4.0	0.15
28	4.0	0.17
32	4.0	0.17
35	4.0	0.17
40	4.0	0.17
42	4.0	0.17



BNGX 10 (HFC)

	0.3	0.6	1.0
	1.10	0.60	0.30



BNGX 10 (HFC)

16	4.0	1/16
18	4.0	1/16
20	4.0	1/16
25	2.8	1/22
28	2.3	1/26
32	1.9	1/32
35	1.7	1/35
40	1.3	1/46
42	1.3	1/46

ANHX 10

16	1.6	2.65/100
18	1.3	2.15/100
20	1.1	1.80/100
25	0.8	1.25/100
28	0.7	1.10/100
32	0.5	0.75/100
35	0.5	0.75/100
40	0.4	0.55/100
42	0.4	0.55/100



BNGX 10 (HFC)

		f_{max}
16	0.4	0.15
18	0.7	0.15
20	0.7	0.15
25	0.7	0.15
28	0.7	0.2
32	0.7	0.2
35	0.7	0.2
40	0.7	0.2
42	0.7	0.2



BNGX 10 (HFC)

	DMIN	DMAX		
16	22.4	31.8	0.5	0.5
18	25.4	35.8	0.5	0.5
20	29.4	39.8	0.5	0.5
25	39.4	49.8	0.5	0.5
28	45.4	55.8	0.5	0.5
32	53.4	63.8	0.5	0.5
35	59.4	69.8	0.5	0.5
40	69.4	79.8	0.5	0.5
42	73.4	83.8	0.5	0.5



	μm	3	5	10	15	20	30	40	50	60	80	100
16		0.438	0.566	0.800	0.980	1.131	1.386	1.600	1.789	1.960	2.263	2.530
18		0.465	0.600	0.849	1.039	1.200	1.470	1.697	1.897	2.078	2.400	2.683
20		0.490	0.632	0.894	1.095	1.265	1.549	1.789	2.000	2.191	2.530	2.828
25		0.548	0.707	1.000	1.225	1.414	1.732	2.000	2.236	2.449	2.828	3.162
28		0.580	0.748	1.058	1.296	1.497	1.833	2.117	2.366	2.592	2.993	3.347
32		0.620	0.800	1.131	1.386	1.600	1.960	2.263	2.530	2.771	3.200	3.578
35		0.648	0.837	1.183	1.449	1.673	2.049	2.366	2.646	2.898	3.347	3.742
40		0.693	0.894	1.265	1.549	1.789	2.191	2.530	2.828	3.098	3.578	4.000
42		0.710	0.917	1.296	1.587	1.833	2.245	2.592	2.898	3.175	3.666	4.099

ANHX 10

	μm	3	5	10	15	20	30	40	50	60	80	100
2.0		0.219	0.283	0.400	0.490	0.566	0.693	0.800	0.894	0.980	1.131	1.265

i

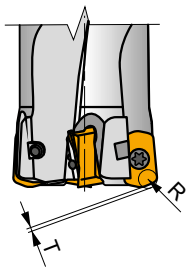

	R	T
BNGX 10T308	1.60	0.44

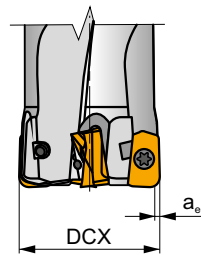

	max a_e / DCX
ANHX 10T320	0.05



SSN11



PRAMET

S



High Feed Milling Cutter for SN.. 11 inserts with Internal Coolant, Next Generation

High-feed milling cutter for bigger diameters utilising double-sided SNXG 11 inserts with eight cutting edges and APMX of 1.7 mm. Internal coolant. Suitable for a wide range of applications. Available in cylindrical, modular and arbor style in range of Ø32 up to Ø125 mm. Body treated for longer tool life.

KAPR	18°
APMX	1.7 mm

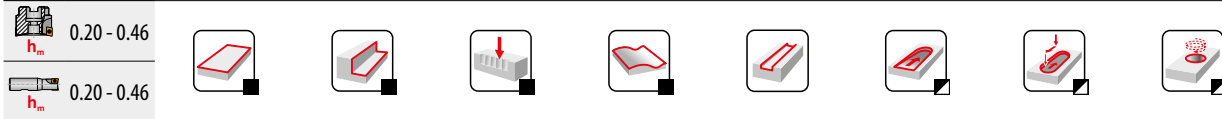
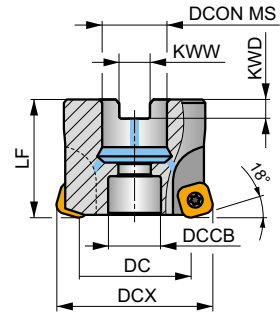
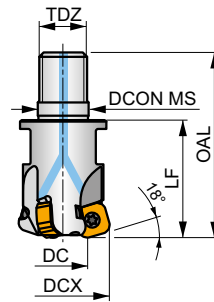
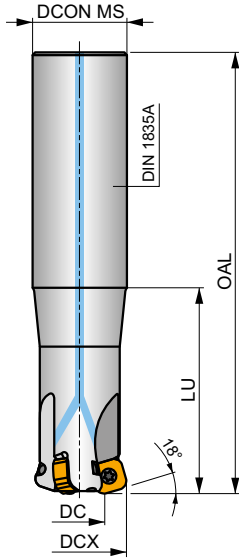
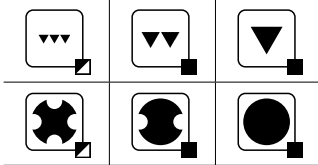
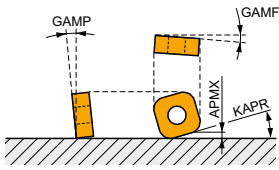

Product	DCX	DC	OAL	DCON MS	DCCB	LU	LF	TDZ	KWW	KWD	GAMF	GAMP	ZNP	max.	kg	G1339	C0314	C0318	C0320	C0322	C0324	AC001	AC002	AC003
	[mm]	[mm]	[mm]	[mm]	[mm]	[mm]	[mm]	[mm]	[mm]	[mm]	[°]	[°]												
32E3R070A32-SSN11-C	32	18.3	150	32	-	70	-	-	-	-	-11.5	-10	3	-	-	17500	✓	0.69	G1339	C0314	-	-	-	-
32E3R120A32-SSN11-C	32	18.3	200	32	-	120	-	-	-	-	-11.5	-10	3	-	-	17500	✓	0.89	G1339	C0314	-	-	-	-
35E3R050A32-SSN11-C	35	21.2	200	32	-	50	-	-	-	-	-11	-10	3	-	-	16800	✓	1.11	G1339	C0314	-	-	-	-
32E3R040M16-SSN11-C	32	18.3	63	17	-	-	40	M16	-	-	-11.5	-10	3	-	-	17500	✓	0.17	G1339	C0314	-	-	-	-
35E3R040M16-SSN11-C	35	21.2	63	17	-	-	40	M16	-	-	-11	-10	3	-	-	16800	✓	0.19	G1339	C0314	-	-	-	-
40E4R043M16-SSN11-C	40	26.2	66	17	-	-	43	M16	-	-	-10.5	-10	4	-	✓	15700	✓	0.23	G1339	C0314	-	-	-	-
40A04R-SMOSN11-C	40	26.2	-	16	12.4	-	40	-	8.4	5.6	-10.5	-10	4	-	✓	15700	✓	0.19	G1339	C0316	-	-	-	-
42A04R-SMOSN11-C	42	28.2	-	16	14.1	-	40	-	8.4	5.6	-10.5	-10	4	-	✓	15300	✓	0.21	G1339	C0318	-	-	-	-
50A05R-SMOSN11-C	50	36.1	-	22	18.1	-	40	-	10.4	6.3	-10	-10	5	-	✓	14000	✓	0.31	G1339	C0320	-	-	-	-
50A06R-SMOSN11-C	50	36.1	-	22	18.1	-	40	-	10.4	6.3	-10	-10	6	-	✓	14000	✓	0.31	G1339	C0320	-	-	-	-
52A05R-SMOSN11-C	52	38.1	-	22	18.1	-	40	-	10.4	6.3	-10	-10	5	-	✓	13800	✓	0.34	G1339	C0320	-	-	-	-
52A06R-SMOSN11-C	52	38.1	-	22	18.1	-	40	-	10.4	6.3	-10	-10	6	-	✓	13800	✓	0.33	G1339	C0320	-	-	-	-
63A06R-SMOSN11-C	63	49.1	-	22	18.1	-	40	-	10.4	6.3	-10	-10	6	-	✓	12500	✓	0.46	G1339	C0320	-	-	-	-
63A08R-SMOSN11-C	63	49.1	-	22	18.1	-	40	-	10.4	6.3	-10	-10	8	-	✓	12500	✓	0.47	G1339	C0320	-	-	-	-
66A06R-SMOSN11-C	66	52.1	-	27	18.1	-	50	-	12.4	7	-10	-10	6	-	✓	12200	✓	0.74	G1339	C0322	-	-	-	-
66A08R-SMOSN11-C	66	52.1	-	27	18.1	-	50	-	12.4	7	-10	-10	8	-	✓	12200	✓	0.75	G1339	C0322	-	-	-	-
80A07R-SMOSN11-C	80	66.1	-	27	38.1	-	50	-	12.4	7	-10	-10	7	-	✓	11100	✓	0.95	G1339	C0324	AC001	-	-	-
80A09R-SMOSN11-C	80	66.1	-	27	38.1	-	50	-	12.4	7	-10	-10	9	-	✓	11100	✓	1.04	G1339	C0324	AC001	-	-	-
100A08R-SMOSN11-C	100	86.1	-	32	45.1	-	50	-	14.4	8	-10	-10	8	-	✓	9900	✓	1.63	G1339	C0324	AC002	-	-	-
115A08R-SMOSN11-C	115	101.1	-	32	45.1	-	50	-	14.4	8	-10	-10	8	-	✓	9200	✓	2.34	G1339	C0324	AC002	-	-	-
125A08R-SMOSN11-C	125	111.1	-	40	56.1	-	63	-	16.4	9	-10	-10	8	-	✓	8900	✓	3.39	G1339	C0324	AC003	-	-	-



G1339



SNXG 1104..



C0314	US 44012-T15P	3.5	M 4	12	–	–	Flag T15P	–	–
C0316	US 44012-T15P	3.5	M 4	12	D-T08P/T15P	FG-15	–	–	HCS 0840C
C0318	US 44012-T15P	3.5	M 4	12	D-T08P/T15P	FG-15	–	–	HS 90835
C0320	US 44012-T15P	3.5	M 4	12	D-T08P/T15P	FG-15	–	–	HS 1030C
C0322	US 44012-T15P	3.5	M 4	12	D-T08P/T15P	FG-15	–	–	HS 1230C
C0324	US 44012-T15P	3.5	M 4	12	D-T08P/T15P	FG-15	–	–	–

AC001		KS 1230	K.FMH27
AC002		KS 1635	K.FMH32
AC003		KS 2040	K.FMH40

SNGX 11



	IC	D1	S
	[mm]	[mm]	[mm]
1104	10.600	4.56	4.76

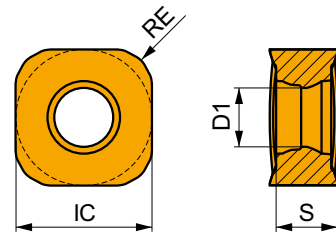

Suitability and starting values for cutting speed (vc), feed (f) and depth of cut (ap). Refer to our Machining Calculator app for further calculations.

Product	RE	P			M			K			N			S			H		
		vc	f	ap	vc	f	ap	vc	f	ap	vc	f	ap	vc	f	ap	vc	f	ap
	[mm]	[m/min]	[mm/tooth]	[mm]	[m/min]	[mm/tooth]	[mm]	[m/min]	[mm/tooth]	[mm]	[m/min]	[mm/tooth]	[mm]	[m/min]	[mm/tooth]	[mm]	[m/min]	[mm/tooth]	[mm]

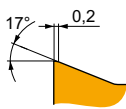

M geometry with positive design for high feed machining.

SNGX 110416SR-M	8215	1.6	■	260	0.60	1.0	■	–	–	–	■	245	0.60	1.0	■	–	–	–	–	–	–
	M8310	1.6	■	275	0.60	1.0	■	–	–	–	■	260	0.60	1.0	■	–	–	–	–	–	–
	M8330	1.6	■	260	0.60	1.0	■	–	–	–	■	245	0.60	1.0	■	–	–	–	–	–	–
	M8340	1.6	■	245	0.60	1.0	■	–	–	–	■	230	0.60	1.0	■	–	–	–	–	–	–
	M9325	1.6	■	305	0.60	1.0	■	–	–	–	■	285	0.60	1.0	■	–	–	–	–	–	–
	M9340	1.6	■	270	0.60	1.0	■	–	–	–	■	–	–	–	■	–	–	–	–	–	–

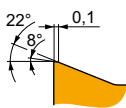

MM geometry with highly positive design for high feed machining.

SNGX 110416SR-MM	M6330	1.6	■	175	0.60	1.0	■	125	0.54	1.0	■	–	–	–	■	50	0.42	0.8	■	–	–	–
	M8340	1.6	■	190	0.60	1.0	■	110	0.54	1.0	■	–	–	–	■	45	0.42	0.8	■	–	–	–
	M8345	1.6	■	150	0.60	1.0	■	90	0.54	1.0	■	–	–	–	■	35	0.42	0.8	■	–	–	–
	M9340	1.6	■	210	0.60	1.0	■	125	0.54	1.0	■	–	–	–	■	50	0.42	0.8	■	–	–	–



a_e / DCX	5 %	10 %	15 %	20 %	25 %	30 %	40 %	50 %	60 %	70 %	75 %	80 %	90 %	100 %
	1.48	1.35	1.27	1.22	1.19	1.16	1.11	1.08	1.05	1.03	1.00	1.00	1.00	1.00
	2.20	1.60	1.35	1.20	1.10	0.95	0.85	0.75	0.85	0.95	1.00	1.00	1.00	1.00
	0.64	0.64	0.64	0.64	0.64	0.65	0.65	0.67	0.68	0.71	0.72	0.74	0.79	1.00

	SNGX 11 - M	SNGX 11 - MM
	1.6	1.6
	-	-

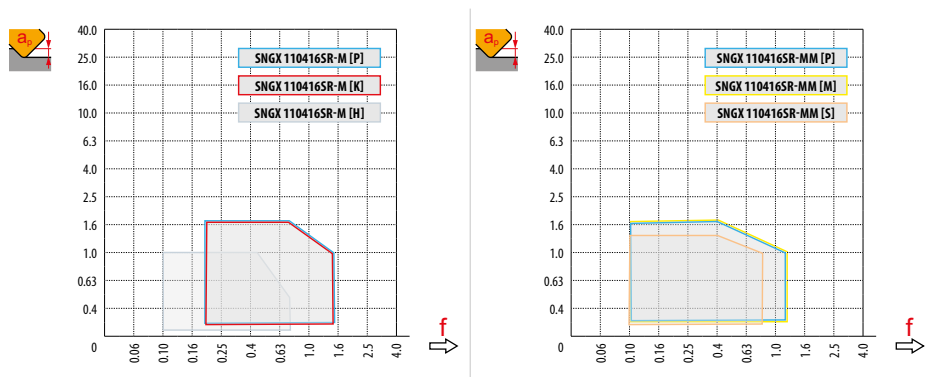

HFC														
DCX	a_e	0.00	0.20	0.40	0.60	0.80	1.00	1.10	1.20	1.30	1.40	1.50	1.60	1.70
32		18.30	19.53	20.76	21.99	23.22	24.46	25.07	25.69	26.30	26.92	27.53	28.15	28.76
35		21.20	22.43	23.66	24.89	26.12	27.36	27.97	28.59	29.20	29.82	30.43	31.05	31.66
40		26.20	27.43	28.66	29.89	31.12	32.36	32.97	33.59	34.20	34.82	35.43	36.05	36.66
42		28.20	29.43	30.66	31.89	33.12	34.36	34.97	35.59	36.20	36.82	37.43	38.05	38.66
50		36.10	37.33	38.56	39.79	41.02	42.26	42.87	43.49	44.10	44.72	45.33	45.95	46.56
52		38.10	39.33	40.56	41.79	43.02	44.26	44.87	45.49	46.10	46.72	47.33	47.95	48.56
63		49.10	50.33	51.56	52.79	54.02	55.26	55.87	56.49	57.10	57.72	58.33	58.95	59.56
66		52.10	53.33	54.56	55.79	57.02	58.26	58.87	59.49	60.10	60.72	61.33	61.95	62.56
80		66.10	67.33	68.56	69.79	71.02	72.26	72.87	73.49	74.10	74.72	75.33	75.95	76.56
100		86.10	87.33	88.56	89.79	91.02	92.26	92.87	93.49	94.10	94.72	95.33	95.95	96.56
115		101.10	102.33	103.56	104.79	106.02	107.26	107.87	108.49	109.10	109.72	110.33	110.95	111.56
125	111.10	112.33	113.56	114.79	116.02	117.26	117.87	118.49	119.10	119.72	120.33	120.95	121.56	
		-	0.20	0.40	0.60	0.80	1.00	1.10	1.20	1.30	1.40	1.50	1.60	1.70
		-	1.37	0.98	0.81	0.71	0.64	0.62	0.59	0.58	0.56	0.54	0.53	0.52

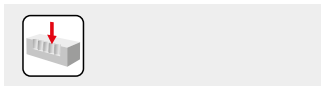

SNGX		
DCX	$d_{e\max}$	f_{\max}
32	5.0	0.25
35	5.0	0.25
40	5.2	0.30
42	5.2	0.30
50	5.3	0.30
52	5.3	0.30
63	5.4	0.30
66	5.4	0.30
80	5.5	0.35
100	5.5	0.35
115	5.5	0.35
125	5.5	0.35

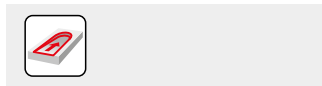

SNGX (HFC)		
DCX	RPMX	APMX/II
32	0.8	1.4/100
35	0.8	1.4/100
40	0.7	1.2/100
42	0.7	1.2/100
50	0.5	0.9/100
52	0.5	0.9/100
63	0.4	0.7/100
66	0.4	0.7/100
80	0.3	0.5/100
100	0.2	0.3/100
115	0.2	0.3/100
125	0.2	0.3/100

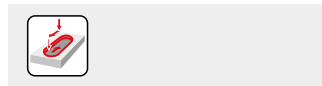

SNGX (HFC)		
DCX	a_p	f_{\max}
32	0.2	0.3
35	0.2	0.3
40	0.2	0.3
42	0.2	0.3
50	0.3	0.4
52	0.3	0.4
63	0.3	0.4
66	0.3	0.4
80	0.3	0.4
100	0.3	0.4
115	0.3	0.4
125	0.3	0.4





DCX	μm	3	5	10	15	20	30	40	50	60	80	100
32		0.620	0.800	1.131	1.386	1.600	1.960	2.263	2.530	2.771	3.200	3.578
35		0.648	0.837	1.183	1.449	1.673	2.049	2.366	2.646	2.898	3.347	3.742
40		0.693	0.894	1.265	1.549	1.789	2.191	2.530	2.828	3.098	3.578	4.000
42		0.710	0.917	1.296	1.587	1.833	2.245	2.592	2.898	3.175	3.666	4.099
50		0.775	1.000	1.414	1.732	2.000	2.449	2.828	3.162	3.464	4.000	4.472
52		0.790	1.020	1.442	1.766	2.040	2.498	2.884	3.225	3.533	4.079	4.561
63		0.869	1.122	1.587	1.944	2.245	2.750	3.175	3.550	3.888	4.490	5.020
66		0.890	1.149	1.625	1.990	2.298	2.814	3.250	3.633	3.980	4.596	5.138
80		0.980	1.265	1.789	2.191	2.530	3.098	3.578	4.000	4.382	5.060	5.657
100		1.095	1.414	2.000	2.449	2.828	3.464	4.000	4.472	4.899	5.657	6.325
115		1.175	1.517	2.145	2.627	3.033	3.715	4.290	4.796	5.254	6.066	6.782
125		1.225	1.581	2.236	2.739	3.162	3.873	4.472	5.000	5.477	6.325	7.071



SNGX				
a_p	0.2	0.5	1.0	1.7
f	1.20	1.00	0.50	0.25



SNGX (HFC)

	DMIN	DMAX		
32	48.0	63.8	0.7	1.4
35	54.0	69.8	0.8	1.5
40	64.0	79.8	0.9	1.5
42	68.0	83.8	1.0	1.6
50	84.0	99.8	0.9	1.4
52	88.0	103.8	1.0	1.4
63	109.0	125.8	1.0	1.4
66	115.0	131.8	1.1	1.4
80	143.0	159.8	1.0	1.3
100	183.0	199.8	0.9	1.1
115	213.0	229.8	1.1	1.3
125	233.0	249.8	1.2	1.4

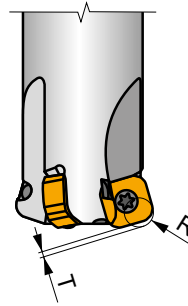

SNGX	R	T
SNGX 110416	4.6	0.92



SPD09



PRAMET

S



PENTA HF High-Feed Milling Cutter with Internal Coolant

Productive high-feed milling cutter utilising single-sided positive PD. 09 insert with 5 cutting edges and APMX of 2 mm. Internal coolant. Suitable for a wide range of applications. Available in cylindrical and arbor style, in range of Ø32 up to Ø140 mm. Body treated for longer tool life.

PENTA HF

KAPR	19°
APMX	2.0 mm

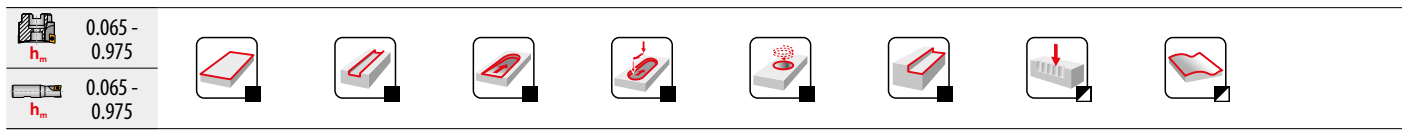
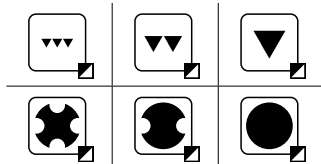
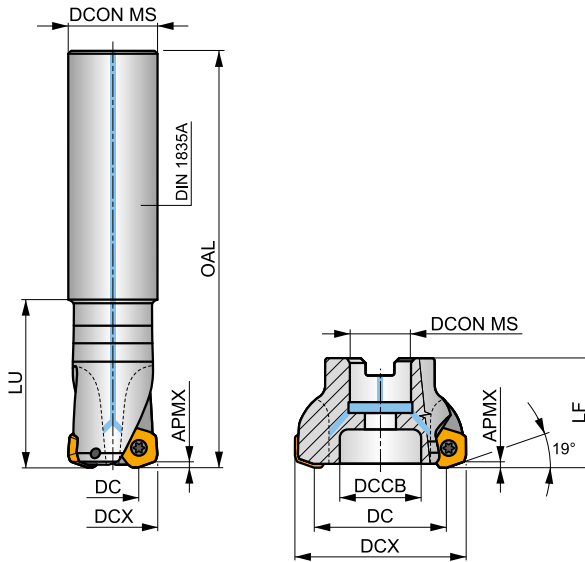
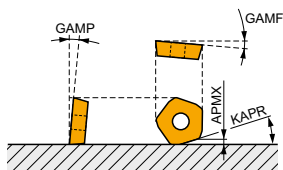

Product	DCX	DC	OAL	DCON MS	DCCB	LU	LF	GAMF	GAMP	max.	kg	GI245	C0340	C0341	C0342	C0343	C0349
	[mm]	[mm]	[mm]	[mm]	[mm]	[mm]	[mm]	[°]	[°]								
32E2R060A32-SPD09-C	32	18.4	250	32	-	60	-	-24	10	2	-	13100	✓	1.54	GI245	C0340	-
40E3R060A32-SPD09-C	40	25.5	250	32	-	60	-	-11	10	3	-	11700	✓	1.43	GI245	C0340	-
42A03R-S19PD09-C	42	27.5	-	16	12	-	40	-8	10	3	-	11500	✓	0.18	GI245	C0342	-
50A04R-S19PD09-C	50	35.3	-	22	18	-	40	-3	10	4	-	10500	✓	0.23	GI245	C0343	-
50A05R-S19PD09-C	50	35.3	-	22	18	-	40	-3	10	5	-	10500	✓	0.36	GI245	C0343	-
52A04R-S19PD09-C	52	37.3	-	22	18	-	40	-3	10	4	-	10300	✓	0.25	GI245	C0343	-
63A05R-S19PD09-C	63	48.2	-	22	18	-	40	-1	10	5	-	9400	✓	0.33	GI245	C0343	-
63A06R-S19PD09-C	63	48.2	-	22	18	-	40	-1	10	6	-	9300	✓	0.46	GI245	C0343	-
66A06R-S19PD09-C	66	51.2	-	22	18	-	40	-1	10	6	-	9200	✓	0.35	GI245	C0343	-
66A06R-S19PD09-CF	66	51.2	-	27	22	-	50	-1	10	6	-	9100	✓	0.68	GI245	C0344	-
80A05R-S19PD09-C	80	65.3	-	27	37	-	50	-1	10	5	-	8300	✓	0.84	GI245	C0341	AC001
80A06R-S19PD09-C	80	65.3	-	27	37	-	50	-1	10	6	-	8300	✓	0.88	GI245	C0341	AC001
100A06R-S19PD09-C	100	58.3	-	32	45	-	50	-1	10	6	-	7400	✓	1.46	GI245	C0341	AC002
100A08R-S19PD09-C	100	85.3	-	32	45	-	50	-1	10	8	-	7400	✓	1.40	GI245	C0341	AC002
125A08R-S19PD09-C	125	110.3	-	40	36	-	63	-1	10	8	-	6600	✓	3.16	GI245	C0349	-
125A10R-S19PD09-C	125	110.3	-	40	36	-	63	-1	10	10	-	6600	✓	3.15	GI245	C0349	-
140A08R-S19PD09-C	140	125.3	-	40	36	-	63	-1	10	8	-	6200	✓	3.62	GI245	C0349	-

GI245	PD.X 0905ZE..	PDKT 0905..	PDMW 0905..

C0340	US 45011-T20P	5.0	M 5	11	-	Flag T20P
C0341	US 45011-T20P	5.0	M 5	11	SDR T20P-T	-



C0342	US 45011-T20P	5.0	M 5	11	SDR T20P-T	HS 90835	–
C0343	US 45011-T20P	5.0	M 5	11	SDR T20P-T	HS 1030C	–
C0344	US 45011-T20P	5.0	M 5	11	SDR T20P-T	HS 1230C	–
C0349	US 45011-T20P	5.0	M 5	11	SDR T20P-T	HSD 2040	–

AC001	KS 1230	K.FMH27
AC002	KS 1635	K.FMH32

PDKX 09



	BS	IC	D1	L	S
	[mm]	[mm]	[mm]	[mm]	[mm]
0905	2.00	13.500	5.50	9.00	5.47

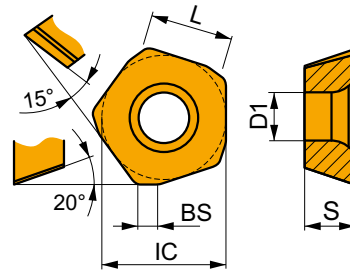

Suitability and starting values for cutting speed (vc), feed (f) and depth of cut (ap). Refer to our Machining Calculator app for further calculations.

Product	RE [mm]	P			M			K			N			S			H		
		vc [m/min]	f [mm/tooth]	ap [mm]	vc [m/min]	f [mm/tooth]	ap [mm]	vc [m/min]	f [mm/tooth]	ap [mm]	vc [m/min]	f [mm/tooth]	ap [mm]	vc [m/min]	f [mm/tooth]	ap [mm]			

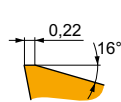

FM geometry with highly positive design for medium high feed machining.

PDKX 0905ZEER-FM	M6330	–	■ 195	1.00	1.2	■ 135	0.90	1.2	–	–	–	–	–	–	■ 55	0.70	1.0	–	–	–
	M8345	–	■ 165	1.00	1.2	■ 95	0.90	1.2	–	–	–	–	–	–	■ 40	0.70	1.0	–	–	–
	M9340	–	■ 215	1.00	1.2	■ 125	0.90	1.2	–	–	–	–	–	–	■ 50	0.70	1.0	–	–	–



PDMX 09

	BS	IC	D1	L	S
	[mm]	[mm]	[mm]	[mm]	[mm]
0905	2.00	13.500	5.50	9.00	5.47

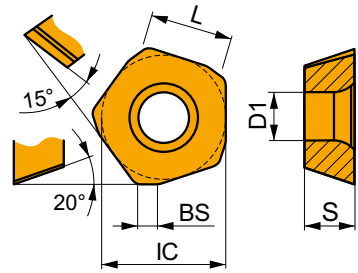

Suitability and starting values for cutting speed (vc), feed (f) and depth of cut (ap). Refer to our Machining Calculator app for further calculations.

Product	RE [mm]	P			M			K			N			S			H		
		vc [m/min]	f [mm/tooth]	ap [mm]	vc [m/min]	f [mm/tooth]	ap [mm]	vc [m/min]	f [mm/tooth]	ap [mm]	vc [m/min]	f [mm/tooth]	ap [mm]	vc [m/min]	f [mm/tooth]	ap [mm]	vc [m/min]	f [mm/tooth]	ap [mm]

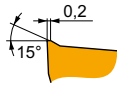

M geometry with positive design for medium high feed machining.

PDMX 0905ZEER-M	8215	–	■	215	1.00	1.2	☑	125	0.90	1.2	☑	200	1.00	1.2	–	–	–	–	–	–
	M8330	–	■	220	1.00	1.2	■	130	0.90	1.2	☑	205	1.00	1.2	–	–	–	–	–	–
	M8345	–	■	165	1.00	1.2	■	95	0.90	1.2	–	–	–	–	–	–	–	–	–	–
	M9340	–	■	215	1.00	1.2	■	125	0.90	1.2	–	–	–	–	–	–	–	–	–	–

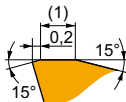

R geometry with strong design for high feed machining.

PDMX 0905ZESR-R	8215	–	☑	215	1.00	1.3	–	–	–	–	■	200	1.00	1.3	–	–	–	–	–	■	40	0.15	1.0
	M8330	–	☑	215	1.00	1.3	–	–	–	■	200	1.00	1.3	–	–	–	–	–	–	■	40	0.15	1.0
	M8345	–	☑	165	1.00	1.3	–	–	–	–	–	–	–	–	–	–	–	–	–	–	–	–	–
	M9325	–	☑	245	1.00	1.3	–	–	–	■	230	1.00	1.3	–	–	–	–	–	–	■	45	0.15	1.0



PDKT 09

PRAMET

	IC	D1	L	S
	[mm]	[mm]	[mm]	[mm]
0905	13.500	5.50	9.00	5.47

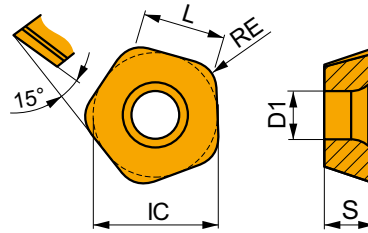

Suitability and starting values for cutting speed (vc), feed (f) and depth of cut (ap). Refer to our Machining Calculator app for further calculations.

Product	RE	P			M			K			N			S			H		
		vc	f	ap	vc	f	ap	vc	f	ap	vc	f	ap	vc	f	ap	vc	f	ap
	[mm]	[m/min]	[mm/tooth]	[mm]	[m/min]	[mm/tooth]	[mm]	[m/min]	[mm/tooth]	[mm]	[m/min]	[mm/tooth]	[mm]	[m/min]	[mm/tooth]	[mm]	[m/min]	[mm/tooth]	[mm]

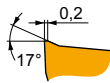

FM geometry with highly positive design for light to medium high feed machining.

PDKT 090530ER-FM	8215	3.0	240	1.00	1.2	140	0.90	1.2	225	1.00	1.2	-	-	-	60	0.70	1.0	-	-	-
	M6330	3.0	210	1.00	1.2	150	0.90	1.2	-	-	-	-	-	-	60	0.70	1.0	-	-	-
	M8310	3.0	250	1.00	1.2	125	0.90	1.2	235	1.00	1.2	-	-	-	-	-	-	-	-	-
	M8330	3.0	245	1.00	1.2	145	0.90	1.2	230	1.00	1.2	-	-	-	60	0.70	1.0	-	-	-
	M8345	3.0	180	1.00	1.2	105	0.90	1.2	-	-	-	-	-	-	45	0.70	1.0	-	-	-
	M9325	3.0	275	1.00	1.2	-	-	-	260	1.00	1.2	-	-	-	-	-	-	-	-	-

PDMW 09

PRAMET

	IC	D1	L	S
	[mm]	[mm]	[mm]	[mm]
0905	13.500	5.50	9.00	5.47

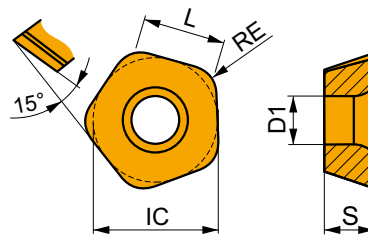

Suitability and starting values for cutting speed (vc), feed (f) and depth of cut (ap). Refer to our Machining Calculator app for further calculations.

Product	RE	P			M			K			N			S			H		
		vc	f	ap	vc	f	ap	vc	f	ap	vc	f	ap	vc	f	ap	vc	f	ap
	[mm]	[m/min]	[mm/tooth]	[mm]	[m/min]	[mm/tooth]	[mm]	[m/min]	[mm/tooth]	[mm]	[m/min]	[mm/tooth]	[mm]	[m/min]	[mm/tooth]	[mm]	[m/min]	[mm/tooth]	[mm]

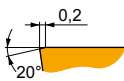

Zero rake angle design for high feed machining.

PDMW 090530SR	M8310	3.0	245	1.00	1.4	-	-	-	230	1.00	1.4	-	-	-	-	-	-	45	0.15	1.0
	M8345	3.0	180	1.00	1.4	-	-	-	-	-	-	-	-	-	-	-	-	-	-	-
	M9325	3.0	270	1.00	1.4	-	-	-	255	1.00	1.4	-	-	-	-	-	-	50	0.15	1.0

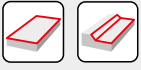

a_s DCX	5%	10%	15%	20%	25%	30%	40%	50%	60%	70%	75%	80%	90%	100%
	1.48	1.35	1.27	1.22	1.19	1.16	1.11	1.08	1.05	1.03	1.00	1.00	1.00	1.00
	2.20	1.60	1.35	1.20	1.10	0.95	0.85	0.75	0.85	0.95	1.00	1.00	1.00	1.00
	0.64	0.64	0.64	0.64	0.64	0.65	0.65	0.67	0.68	0.71	0.72	0.74	0.79	1.00

	PDKX 09-FM	PDMX 09-M	PDMX 09-R	PDKT 09-FM	PDMW 09
	-	-	-	3.0	3.0
	2.00	2.00	2.00	-	-

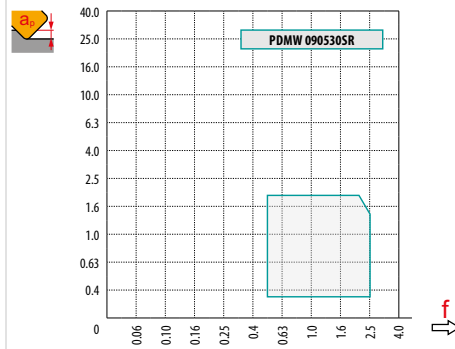
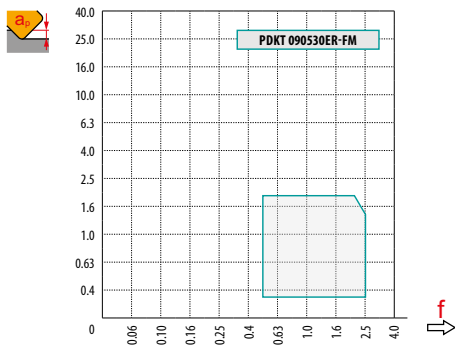
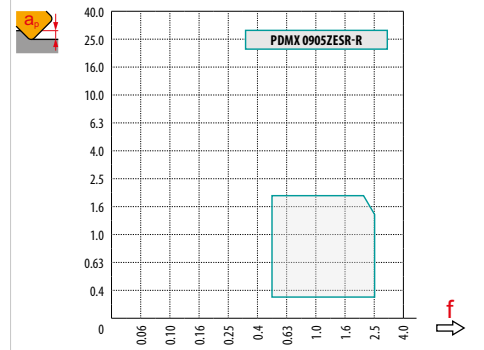
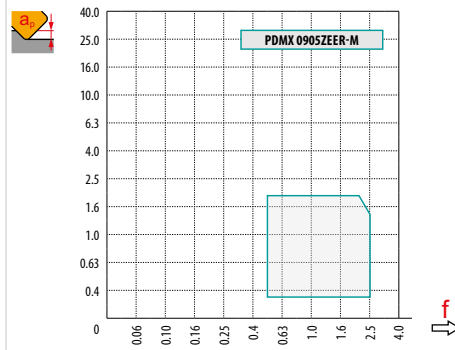
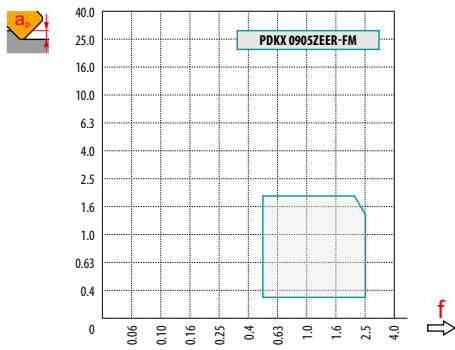

		0.00	0.30	0.40	0.50	0.60	0.70	0.80	0.90	1.00	1.25	1.50	2.00
32		18.4	20.1	20.7	21.3	21.9	22.5	23.0	23.6	24.2	25.7	27.1	30.0
40		25.5	27.2	27.8	28.4	29.0	29.6	30.1	30.7	31.3	32.8	34.2	37.1
42		27.5	29.2	29.8	30.4	31.0	31.6	32.1	32.7	33.3	34.8	36.2	39.1
50		35.3	37.0	37.6	38.2	38.8	39.4	39.9	40.5	41.1	42.6	44.0	46.9
52		37.3	39.0	39.6	40.2	40.8	41.4	41.9	42.5	43.1	44.6	46.0	48.9
63		48.2	49.9	50.5	51.1	51.7	52.3	52.8	53.4	54.0	55.5	56.9	59.8
66		51.2	52.9	53.5	54.1	54.7	55.3	55.8	56.4	57.0	58.5	59.9	62.8
80		65.3	67.0	67.6	68.2	68.8	69.4	69.9	70.5	71.1	72.6	74.0	76.9
100		85.3	87.0	87.6	88.2	88.8	89.4	89.9	90.5	91.1	92.6	94.0	96.9
125		110.3	112.3	112.9	113.5	114.1	114.6	115.2	115.8	116.4	117.9	119.3	122.2
140	125.3	127.3	127.9	128.5	129.1	129.7	130.2	130.8	131.4	132.9	134.3	137.2	
		0.00	0.30	0.40	0.50	0.60	0.70	0.80	0.90	1.00	1.25	1.50	2.00
		-	3.00	3.00	2.90	2.80	2.70	2.60	2.50	2.40	2.25	1.50	1.50



Follow instructions provided for flat surface milling. When milling close to vertical surfaces, decrease feed per tooth (f_z) by 50 % to prevent vibrations and damage of the cutting edge.



DCX	max	f_{max}
32	5.0	0.20
40	5.0	0.20
42	5.0	0.20
50	6.0	0.20
52	6.0	0.20
63	7.0	0.25
66	7.0	0.25
80	8.0	0.30
100	8.0	0.30



	HFC		
a_p	0.5	1.0	2.0
f	3.0	2.3	1.5



DCX	RPMX	APMX/l
40	8.0	1.80/16
42	8.0	2.00/16
50	8.0	2.00/16
52	8.0	2.00/16
63	7.0	2.00/18
66	6.0	2.00/21
80	5.0	2.00/24
100	3.0	2.00/40



DCX	DMIN	DMAX	$\frac{J}{S_{MAX}}$ DMIN	$\frac{J}{S_{MAX}}$ DMAX
40	63.7	80.0	2.00	2.00
42	67.5	84.0	2.00	2.00
50	83.3	100.0	2.00	2.00
52	87.3	104.0	2.00	2.00
63	109.2	126.0	2.00	2.00
66	115.2	132.0	2.00	2.00
80	143.3	160.0	2.00	2.00
100	183.3	200.0	2.00	2.00



DCX	a_p	f_{max}
32	1.8	0.20
40	1.8	0.20
42	2.0	0.20
50	2.0	0.20
52	2.0	0.20
63	2.0	0.25
66	2.0	0.25
80	2.0	0.30
100	2.0	0.30



DCX	μm	3	5	10	15	20	30	40	50	60	80	100
32		0.620	0.800	1.131	1.386	1.600	1.960	2.263	2.530	2.771	3.200	3.578
40		0.693	0.894	1.265	1.549	1.789	2.191	2.530	2.828	3.098	3.578	4.000
42		0.710	0.917	1.296	1.587	1.833	2.245	2.592	2.898	3.175	3.666	4.099
50		0.775	1.000	1.414	1.732	2.000	2.449	2.828	3.162	3.464	4.000	4.472
52		0.790	1.020	1.442	1.766	2.040	2.498	2.884	3.225	3.533	4.079	4.561
63		0.869	1.122	1.587	1.944	2.245	2.750	3.175	3.550	3.888	4.490	5.020
66		0.890	1.149	1.625	1.990	2.298	2.814	3.250	3.633	3.980	4.596	5.138
80		0.980	1.265	1.789	2.191	2.530	3.098	3.578	4.000	4.382	5.060	5.657

i

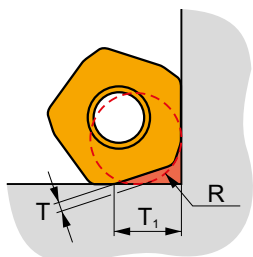

DCX	R	T	T_1
32	4.5	1.1	6.8
40 - 140	4.5	1.1	7.3



SZD07

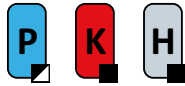

PRAMET



FEED ZD07 High-Feed Milling Cutter with Internal Coolant

Productive high-feed milling cutter utilising single-sided ZD..07 insert with 4 cutting edges and a APMX of 1 mm. Internal coolant. Suitable for a wide range of applications. Available in cylindrical and modular style, in range of Ø16 up to Ø32 mm. Body treated for longer tool life.

FEED ZD

APMX	1.0 mm
------	--------

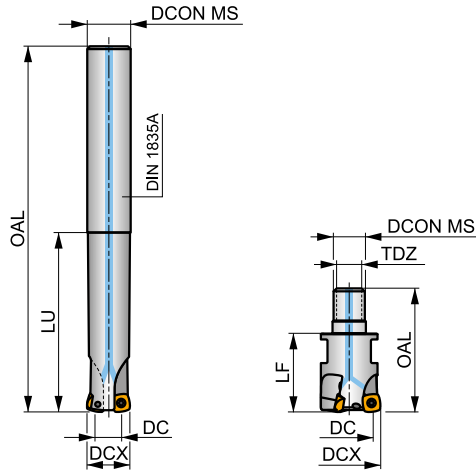
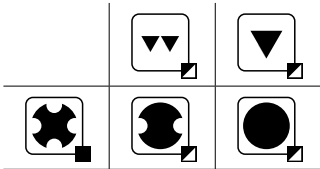
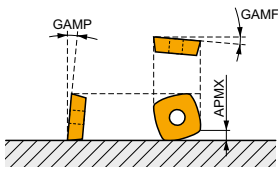

h_m 0.175 - 0.44



Product	DCX	DC	OAL	DCON MS	LU	LF	TDZ	GAMF	GAMP				kg	GI201	C0350	
	[mm]	[mm]	[mm]	[mm]	[mm]	[mm]	[mm]	[°]	[°]							
	16E2R030A16-SZD07	16	6	100	16	30	-	-5	8	2	-	47400	✓	0.13	GI201	C0350
	16E2R065A16-SZD07	16	6	145	16	65	-	-5	8	2	-	47400	✓	0.19	GI201	C0350
	20E3R040A20-SZD07	20	10	120	20	40	-	-5	8	3	-	42400	✓	0.25	GI201	C0350
	20E3R080A20-SZD07	20	10	165	20	80	-	-5	8	3	-	42400	✓	0.33	GI201	C0350
	25E3R050A25-SZD07	25	15	140	25	50	-	-5	8	3	-	37900	✓	0.47	GI201	C0350
25E3R100A25-SZD07	25	15	190	25	100	-	-5	8	3	-	37900	✓	0.60	GI201	C0350	
	16E2R030M08-SZD07	16	6	48	8.5	-	30	M8	-5	8	2	-	✓	0.04	GI201	C0350
	20E3R030M10-SZD07	20	10	49	10.5	-	30	M10	-5	8	3	-	✓	0.08	GI201	C0350
	25E3R032M12-SZD07	25	15	54	12.5	-	32	M12	-5	8	3	-	✓	0.15	GI201	C0350
	25E4R032M12-SZD07	25	15	54	12.5	-	32	M12	-5	8	4	✓	✓	0.04	GI201	C0350
	32E4R040M16-SZD07	32	22	65	17	-	40	M16	-5	8	4	✓	✓	0.22	GI201	C0350

	GI201		ZDCW 0703..
--	-------	--	-------------

	C0350		US 2205-T07P		0.9		M 2.2		5		Flag T07P
--	-------	--	--------------	--	-----	--	-------	--	---	--	-----------



ZDCW 07



	IC	D1	S
	[mm]	[mm]	[mm]
0703	6.800	2.60	3.18

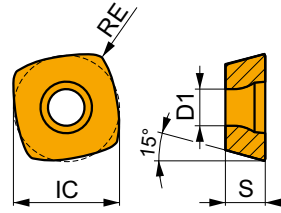

Suitability and starting values for cutting speed (vc), feed (f) and depth of cut (ap). Refer to our Machining Calculator app for further calculations.

Product	RE [mm]	P			M			K			N			S			H		
		vc [m/min]	f [mm/tooth]	ap [mm]	vc [m/min]	f [mm/tooth]	ap [mm]	vc [m/min]	f [mm/tooth]	ap [mm]	vc [m/min]	f [mm/tooth]	ap [mm]	vc [m/min]	f [mm/tooth]	ap [mm]			

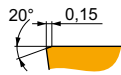
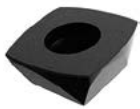

Special geometry for high feed machining.

ZDCW 070304	M8310	0.4	420	0.60	0.4	—	—	—	395	0.60	0.4	—	—	—	—	—	—	—	80	0.15	1.0
	M8325	0.4	325	0.60	0.4	—	—	—	—	—	—	—	—	—	—	—	—	—	—	—	—
	M8345	0.4	305	0.60	0.4	—	—	—	—	—	—	—	—	—	—	—	—	—	—	—	—



a_e DCX	5 %	10 %	15 %	20 %	25 %	30 %	40 %	50 %	60 %	70 %	75 %	80 %	90 %	100 %
	1.48	1.35	1.27	1.22	1.19	1.16	1.11	1.08	1.05	1.03	1.00	1.00	1.00	1.00
	2.20	1.60	1.35	1.20	1.10	0.95	0.85	0.75	0.85	0.95	1.00	1.00	1.00	1.00
	0.64	0.64	0.64	0.64	0.64	0.65	0.65	0.67	0.68	0.71	0.72	0.74	0.79	1.00

ZDCW 07	
	0.4
	-

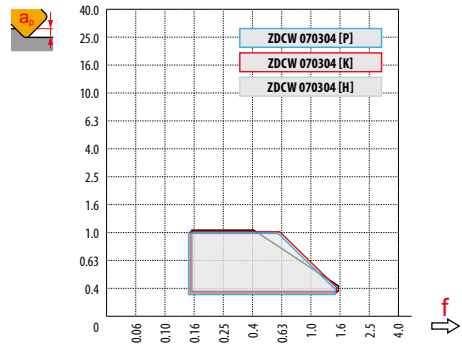

		0.00	0.30	0.40	0.50	0.60	0.70	0.80	0.90	1.00
16		6.0	12.0	12.9	13.7	14.4	15.1	15.7	16.2	16.8
20		10.0	16.0	16.9	17.7	18.4	19.1	19.7	20.2	20.8
25		15.0	21.0	21.9	22.7	23.4	24.1	24.7	25.2	25.8
32		22.0	28.0	28.9	29.7	30.4	31.1	31.7	32.2	32.8
		0.00	0.30	0.40	0.50	0.60	0.70	0.80	0.90	1.00
		-	1.50	1.50	1.13	1.00	0.88	0.75	0.61	0.60

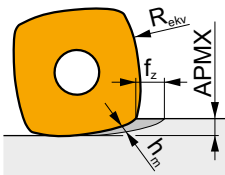

$$f_z = h_m \sqrt{\frac{2R_{ekv}}{APMX}} \quad [\text{mm/tooth}]$$



Follow instructions provided for flat surface milling. When milling close to vertical surfaces, decrease feed per tooth (f_z) by 50 % to prevent vibrations and damage of the cutting edge.

	max.	f_{max}
16	5.6	0.12
20	5.6	0.15
25	5.6	0.17
32	5.6	0.17

HFC			
	0.3	0.6	1.0
	1.50	0.80	0.40

	RPMX	APMX/I
16	7.8	1.0/9
20	9.7	1.0/7
25	4.9	1.0/13
32	2.8	1.0/22

HFC		
	RPMX	APMX/I
16	0.5	0.75/100
20	0.3	0.40/100
25	0.2	0.20/100
32	0.1	0.05/100



DCX	D _{MIN}	D _{MAX}	S _{MAX} D _{MIN}	S _{MAX} D _{MAX}
16	21.0	32.0	0.10	0.40
20	29.0	40.0	0.10	0.30
25	39.0	50.0	0.15	0.25
32	53.0	64.0	0.10	0.15



DCX	a _p	f _{max}
16	0.05	0.12
20	0.05	0.15
25	0.05	0.17
32	0.05	0.17



DCX	μm	3	5	10	15	20	30	40	50	60	80	100
16	FE	0.438	0.566	0.800	0.980	1.131	1.386	1.600	1.789	1.960	2.263	2.530
20		0.490	0.632	0.894	1.095	1.265	1.549	1.789	2.000	2.191	2.530	2.828
25		0.548	0.707	1.000	1.225	1.414	1.732	2.000	2.236	2.449	2.828	3.162
32		0.620	0.800	1.131	1.386	1.600	1.960	2.263	2.530	2.771	3.200	3.578

i

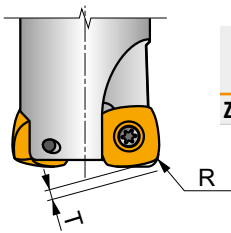

	R	T
ZDCW 070304	1.70	0.60



SZD09

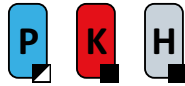

PRAMET

S



FEED ZD09 High-Feed Milling Cutter with Internal Coolant

Productive high-feed milling cutter utilising single-sided ZD..09 insert with 4 cutting edges and APMX of 1 mm. Internal coolant. Suited for a wide range of applications. Available in cylindrical, modular and arbor style, in range of Ø25 up to Ø66 mm. Body treated for longer tool life.

FEED ZD

APMX	1.0 mm
------	--------

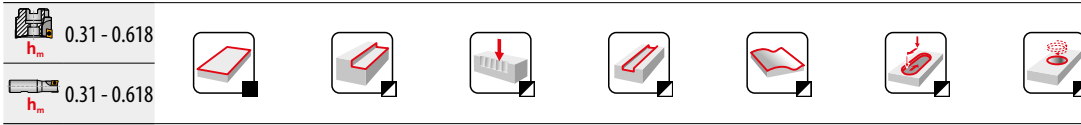
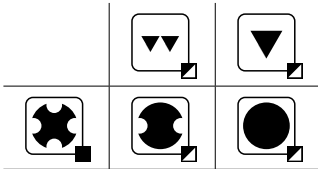
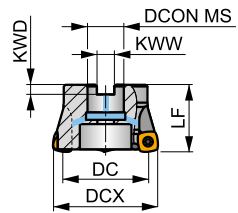
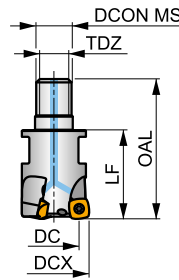
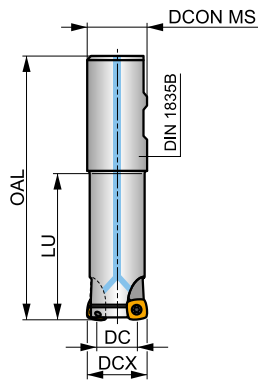
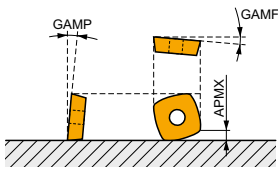

Product	DCX	DC	OAL	DCON MS	LU	LF	TDZ	KWW	KWD	GAMP	GAMP	max.		kg	SQ			
	[mm]	[mm]	[mm]	[mm]	[mm]	[mm]	[mm]	[mm]	[mm]	[°]	[°]							
DIN 1835B	25E2R080B25-SZD09-C	25	11.6	140	25	80	-	-	-	-6	10	2	-	22800	✓	0.49	GI191 SQ400	
	25E2R140B25-SZD09-C	25	11.6	200	25	140	-	-	-	-6	10	2	-	22800	✓	0.63	GI191 SQ400	
	25E2R240B25-SZD09-C	25	11.6	300	25	240	-	-	-	-6	10	2	-	22800	✓	0.90	GI191 SQ400	
	32E2R080B32-SZD09-C	32	18.7	140	32	80	-	-	-	-6	10	2	-	20100	✓	0.80	GI191 SQ400	
	32E2R140B32-SZD09-C	32	18.7	200	32	140	-	-	-	-6	10	2	-	20100	✓	1.07	GI191 SQ400	
	32E2R240B32-SZD09-C	32	18.7	300	32	240	-	-	-	-6	10	2	-	20100	✓	1.57	GI191 SQ400	
MODULAR	25E2R032M12-SZD09-C	25	11.6	54	12.5	-	32	M12	-	-6	10	2	-	-	✓	0.15	GI191 SQ400	
	25E3R032M12-SZD09-C	25	11.6	54	12.5	-	32	M12	-	-6	10	3	-	-	✓	0.14	GI191 SQ400	
	32E3R040M16-SZD09-C	32	18.7	63	17	-	40	M16	-	-6	10	3	-	-	✓	0.26	GI191 SQ400	
	35E4R040M16-SZD09-C	35	21.7	63	17	-	40	M16	-	-6	10	4	✓	-	✓	0.22	GI191 SQ400	
	42E4R040M16-SZD09-C	42	28.7	63	17	-	40	M16	-	-6	10	4	✓	-	✓	0.27	GI191 SQ400	
ISO 6462 DIN 8036	40A03R-SMOZD09-C	40	26.7	-	16	-	40	-	8.4	5.6	-6	10	3	-	18000	✓	0.36	GI191 SQ402
	40A04R-SMOZD09-C	40	26.7	-	16	-	40	-	8.4	5.6	-6	10	4	✓	18000	✓	0.44	GI191 SQ402
	50A05R-SMOZD09-C	50	36.7	-	22	-	40	-	10.4	6.4	-6	10	5	✓	16000	✓	0.43	GI191 SQ403
	52A05R-SMOZD09-C	52	38.7	-	22	-	40	-	10.4	6.4	-6	10	5	✓	15700	✓	0.46	GI191 SQ403
	63A06R-SMOZD09-C	63	49.7	-	22	-	40	-	10.4	6.4	-6	10	6	✓	14300	✓	0.60	GI191 SQ403
	66A06R-SMOZD09-C	66	52.7	-	27	-	50	-	12	7	-6	10	6	✓	14000	✓	0.89	GI191 CO364



CO364	US 3006-T09P	2.0	M 3	6	D-T07P/T09P	FG-15	HS 1230C	-
SQ400	US 3006-T09P	2.0	M 3	6	-	-	Flag T09P	-



SQ402	US 3006-T09P	2.0	M 3	6	D-T07P/T09P	FG-15	–	HS 0830C
SQ403	US 3006-T09P	2.0	M 3	6	D-T07P/T09P	FG-15	–	HS 1030C

ZDCW 09



	IC	D1	S
	[mm]	[mm]	[mm]
09T3	9.525	3.40	3.97

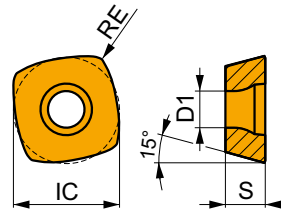

Suitability and starting values for cutting speed (vc), feed (f) and depth of cut (ap). Refer to our Machining Calculator app for further calculations.

Product	RE [mm]	P			M			K			N			S			H		
		vc	f	ap	vc	f	ap	vc	f	ap	vc	f	ap	vc	f	ap			
		[m/min]	[mm/tooth]	[mm]	[m/min]	[mm/tooth]	[mm]	[m/min]	[mm/tooth]	[mm]	[m/min]	[mm/tooth]	[mm]	[m/min]	[mm/tooth]	[mm]	[m/min]	[mm/tooth]	[mm]

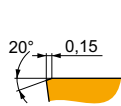
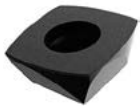

Special geometry for high feed machining.

Product	M	vc	f	ap	M	vc	f	ap	K	vc	f	ap	N	vc	f	ap	S	vc	f	ap	H	vc	f	ap
ZDCW 09T304	M8310	0.4	320	1.00	0.6	–	–	–	M8325	0.4	250	1.00	0.6	–	–	–	–	–	–	–	–	–	–	–
	M8345	0.4	235	1.00	0.6	–	–	–																



a_p DCX	5 %	10 %	15 %	20 %	25 %	30 %	40 %	50 %	60 %	70 %	75 %	80 %	90 %	100 %
	1.48	1.35	1.27	1.22	1.19	1.16	1.11	1.08	1.05	1.03	1.00	1.00	1.00	1.00
	2.20	1.60	1.35	1.20	1.10	0.95	0.85	0.75	0.85	0.95	1.00	1.00	1.00	1.00
	0.64	0.64	0.64	0.64	0.64	0.65	0.65	0.67	0.68	0.71	0.72	0.74	0.79	1.00

ZDCW 09	
	0.4
	-

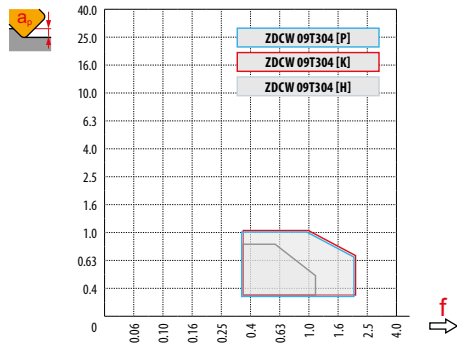

DCX	a_p	0.00	0.30	0.40	0.50	0.60	0.70	0.80	0.90	1.00
25		11.6	17.4	18.2	19.0	19.7	20.3	20.9	21.5	22.0
32		18.7	24.5	25.3	26.1	26.8	27.4	28.0	28.6	29.1
35		21.7	27.3	28.1	28.8	29.5	30.1	30.7	31.2	31.7
40		27.7	33.5	34.3	35.1	35.8	36.4	37.0	37.6	38.1
42		28.7	34.3	35.1	35.8	36.5	37.1	37.7	38.2	38.7
50		36.7	42.3	43.1	43.8	44.5	45.1	45.7	46.2	46.7
52		38.7	44.3	45.1	45.8	46.5	47.1	47.7	48.2	48.7
63		49.7	55.3	56.1	56.8	57.5	58.1	58.7	59.2	59.7
66	52.7	58.3	59.1	59.8	60.5	61.1	61.7	62.2	62.7	
	a_p	0.00	0.30	0.40	0.50	0.60	0.70	0.80	0.90	1.00
		-	2.00	2.00	2.00	1.75	1.50	1.25	1.13	1.00

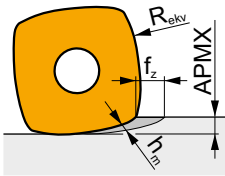

$$f_z = h_m \sqrt{\frac{2R_{ekv}}{APMX}} \quad [\text{mm/tooth}]$$



Follow instructions provided for flat surface milling. When milling close to vertical surfaces, decrease feed per tooth (f_z) by 50 % to prevent vibrations and damage of the cutting edge.



DCX	max	f_{max}
25	7.7	0.15
32	7.7	0.17
40	7.7	0.20



	HFC		
	0.3	0.6	1.0
	2.00	1.50	1.00



	HFC			
DCX	RPMX	APMX/l	RPMX	APMX/l
25	12.0	1.0/6	0.9	1.00/65
32	7.5	1.0/11	0.5	0.75/100
40	3.6	1.0/17	0.4	0.55/100



DCX	DMIN	DMAX	SMAX DMIN	SMAX DMAX
25	35.0	50.0	0.45	1.00
32	49.0	64.0	0.45	0.85
40	65.0	80.0	0.50	0.85



DCX	a	f_{max}
25	0.15	0.15
32	0.15	0.17
40	0.15	0.20



DCX	μm	3	5	10	15	20	30	40	50	60	80	100
25		0,548	0,707	1,000	1,225	1,414	1,732	2,000	2,236	2,449	2,828	3,162
32		0,620	0,800	1,131	1,386	1,600	1,960	2,263	2,530	2,771	3,200	3,578
35		0,648	0,837	1,183	1,449	1,673	2,049	2,366	2,646	2,898	3,347	3,742
40		0,693	0,894	1,265	1,549	1,789	2,191	2,530	2,828	3,098	3,578	4,000
42		0,710	0,917	1,296	1,587	1,833	2,245	2,592	2,898	3,175	3,666	4,099
52		0,790	1,020	1,442	1,766	2,040	2,498	2,884	3,225	3,533	4,079	4,561
63		0,869	1,122	1,587	1,944	2,245	2,750	3,175	3,550	3,888	4,490	5,020
66		0,890	1,149	1,625	1,990	2,298	2,814	3,250	3,633	3,980	4,596	5,138

i

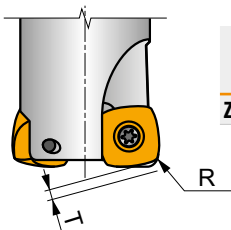

	R	T
ZDCW 09T304	2.27	0.52



SZD12

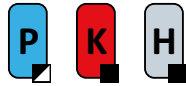

PRAMET

S



FEED ZD12 High-Feed Milling Cutter with Internal Coolant

Highly productive high-feed milling cutter utilising single-sided ZD.. 12 insert with 4 cutting edges and APMX of 1.6 mm. Internal coolant. Suitable for a wide range of applications. Available in cylindrical, modular and arbor style, in range of Ø32 up to Ø80 mm. Body treated for longer tool life.

FEED ZD

APMX	1.6 mm
------	--------

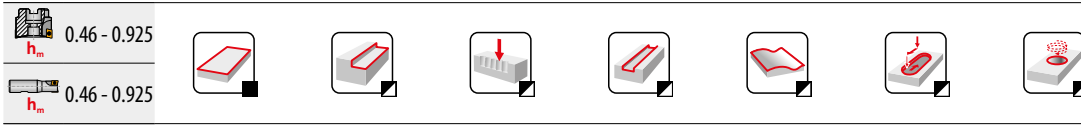
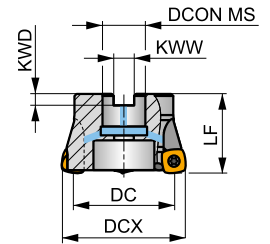
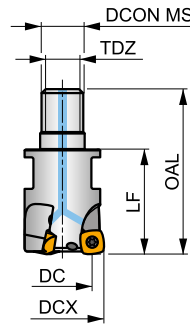
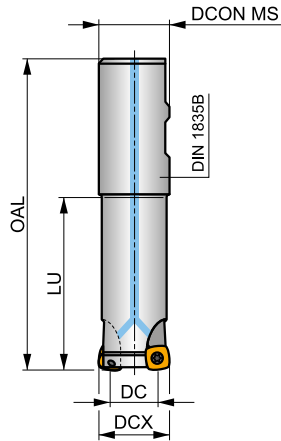
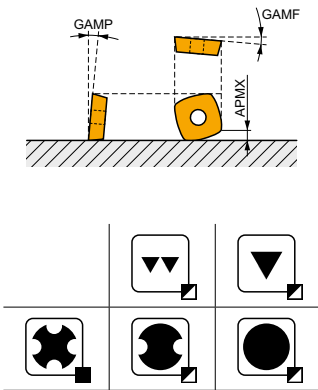

Product	DCX	DC	OAL	DCON MS	LU	LF	TDZ	KWW	KWD	GAMF	GAMP	max.	kg	Icons					
	[mm]	[mm]	[mm]	[mm]	[mm]	[mm]		[mm]	[mm]	[°]	[°]								
40E4R080B32-SZD12-C	40	22.5	140	32	80	-	-	-	-	-6	10	4	✓	15700	✓	0.78	GI192	SQ220	-
40E4R140B32-SZD12-C	40	22.5	200	32	140	-	-	-	-	-6	10	4	✓	15700	✓	1.13	GI192	SQ220	-
32E3R040M16-SZD12-C	32	14.5	63	17	-	40	M16	-	-	-6	10	3	-	-	✓	0.24	GI192	SQ220	-
40E4R040M16-SZD12-C	40	22.5	63	17	-	40	M16	-	-	-6	10	4	-	-	✓	0.23	GI192	SQ220	-
50A04R-SMOZD12-C	50	32.5	-	22	-	40	-	10.4	6.4	-6	10	4	✓	14000	✓	0.47	GI192	SQ033	-
63A05R-SMOZD12-C	63	45.5	-	22	-	40	-	10.4	6.4	-6	10	5	✓	12500	✓	0.63	GI192	SQ033	-
80A05R-SMOZD12-C	80	62.5	-	27	-	50	-	12	7	-6	10	5	✓	11100	✓	1.12	GI192	C0371	AC001

GI192	ZDEW 1204..

Icon	Part Number	Nm	Thread	Length	Material	Material	Material
	US 4011-T15P	3.5	M 4	10.6	D-T08P/T15P	FG-15	-
	US 4011-T15P	3.5	M 4	10.6	D-T08P/T15P	FG-15	HS 1030C
	US 4011-T15P	3.5	M 4	10.6	-	-	Flag T15P

AC001	KS 1230	K.FMH27



ZDEW 12



	IC	D1	S
	[mm]	[mm]	[mm]
1204	12.700	4.40	4.76

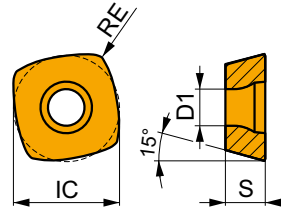

Suitability and starting values for cutting speed (vc), feed (f) and depth of cut (ap). Refer to our Machining Calculator app for further calculations.

Product	RE [mm]	P			M			K			N			S			H		
		vc [m/min]	f [mm/tooth]	ap [mm]	vc [m/min]	f [mm/tooth]	ap [mm]	vc [m/min]	f [mm/tooth]	ap [mm]	vc [m/min]	f [mm/tooth]	ap [mm]	vc [m/min]	f [mm/tooth]	ap [mm]			

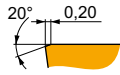

Special geometry for high feed machining.

ZDEW 120408	M8310	0.8	270	1.00	1.0	—	—	—	255	1.00	1.0	—	—	—	—	—	—	50	0.15	1.0
	M8325	0.8	205	1.00	1.0	—	—	—	—	—	—	—	—	—	—	—	—	—	—	—
	M8345	0.8	195	1.00	1.0	—	—	—	—	—	—	—	—	—	—	—	—	—	—	—



a_p DCX	5 %	10 %	15 %	20 %	25 %	30 %	40 %	50 %	60 %	70 %	75 %	80 %	90 %	100 %
	1.48	1.35	1.27	1.22	1.19	1.16	1.11	1.08	1.05	1.03	1.00	1.00	1.00	1.00
	2.20	1.60	1.35	1.20	1.10	0.95	0.85	0.75	0.85	0.95	1.00	1.00	1.00	1.00
	0.64	0.64	0.64	0.64	0.64	0.65	0.65	0.67	0.68	0.71	0.72	0.74	0.79	1.00

ZDEW 12	
	0.8
	-

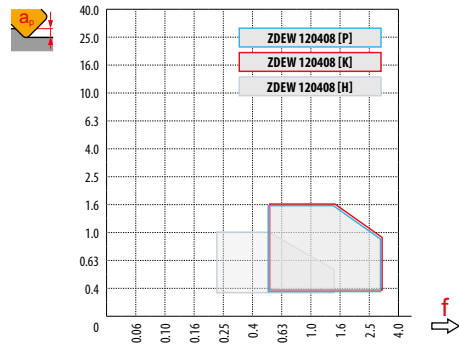

		0.00	0.50	0.60	0.70	0.80	0.90	1.00	1.10	1.20	1.30	1.40	1.50	1.60
32		14.5	22.7	23.5	24.2	24.8	25.4	26.0	26.5	27.0	27.5	28.0	28.5	28.9
40		22.5	30.7	31.5	32.2	32.8	33.4	34.0	34.5	35.0	35.5	36.0	36.5	36.9
50		32.5	40.7	41.5	42.2	42.8	43.4	44.0	44.5	45.0	45.5	46.0	46.5	46.9
52		34.5	42.7	43.5	44.2	44.8	45.4	46.0	46.5	47.0	47.5	48.0	48.5	48.9
63		45.5	53.7	54.5	55.2	55.8	56.4	57.0	57.5	58.0	58.5	59.0	59.5	59.9
66		48.5	56.7	57.5	58.2	58.8	59.4	60.0	60.5	61.0	61.5	62.0	62.5	62.9
80		62.5	70.7	71.5	72.2	72.8	73.4	74.0	74.5	75.0	75.5	76.0	76.5	76.9
		0.00	0.50	0.60	0.70	0.80	0.90	1.00	1.10	1.20	1.30	1.40	1.50	1.60
		-	3.00	3.00	3.00	3.00	3.00	3.00	2.50	2.25	2.00	1.80	1.65	1.50

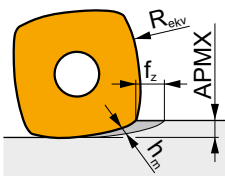

$$f_z = h_m \sqrt{\frac{2R_{ekv}}{APMX}} \quad [\text{mm/tooth}]$$





Follow instructions provided for flat surface milling. When milling close to vertical surfaces, decrease feed per tooth (f_z) by 50 % to prevent vibrations and damage of the cutting edge.

DCX	max	f _{max}
32	10.0	0.15
40	10.0	0.17
50	10.0	0.20
52	10.0	0.20
63	10.0	0.20
66	10.0	0.20
80	10.0	0.25





HFC			
	0.5	1.0	1.6
	3.00	2.00	1.50





HFC			HFC	
DCX	RPMX	APMX/I	RPMX	APMX/I
32	10	1.6/11	1.2	1.60/78
40	5.5	1.6/18	0.7	1.10/100
50	3.3	1.6/29	0.5	0.75/100
52	3.1	1.6/31	0.5	0.75/100
63	2.2	1.6/43	0.3	0.40/100
66	2.0	1.6/47	0.3	0.40/100
80	1.5	1.6/63	0.2	0.20/100



DCX	DMIN	DMAX	 SMAX DMIN	 SMAX DMAX
32	44.0	64.0	0.75	1.60
40	60.0	80.0	0.75	1.50
50	80.0	100.0	0.80	1.35
52	84.0	104.0	0.80	1.35
63	106.0	126.0	0.70	1.00
66	112.0	132.0	0.70	1.00
80	140.0	160.0	0.65	0.85



DCX		f _{max}
32	0.25	0.15
40	0.25	0.17
50	0.25	0.20
52	0.25	0.20
63	0.25	0.20
66	0.25	0.20
80	0.25	0.25



DCX	μm	3	5	10	15	20	30	40	50	60	80	100
32		0.620	0.800	1.131	1.386	1.600	1.960	2.263	2.530	2.771	3.200	3.578
40		0.693	0.894	1.265	1.549	1.789	2.191	2.530	2.828	3.098	3.578	4.000
50		0.775	1.000	1.414	1.732	2.000	2.449	2.828	3.162	3.464	4.000	4.472
52		0.790	1.020	1.442	1.766	2.040	2.498	2.884	3.225	3.533	4.079	4.561
63		0.869	1.122	1.587	1.944	2.245	2.750	3.175	3.550	3.888	4.490	5.020
66		0.890	1.149	1.625	1.990	2.298	2.814	3.250	3.633	3.980	4.596	5.138
80		0.980	1.265	1.789	2.191	2.530	3.098	3.578	4.000	4.382	5.060	5.657

i

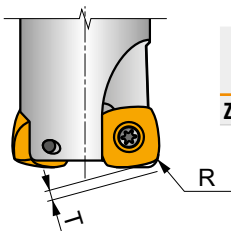

	R	T
ZDEW 120408	3.52	0.64

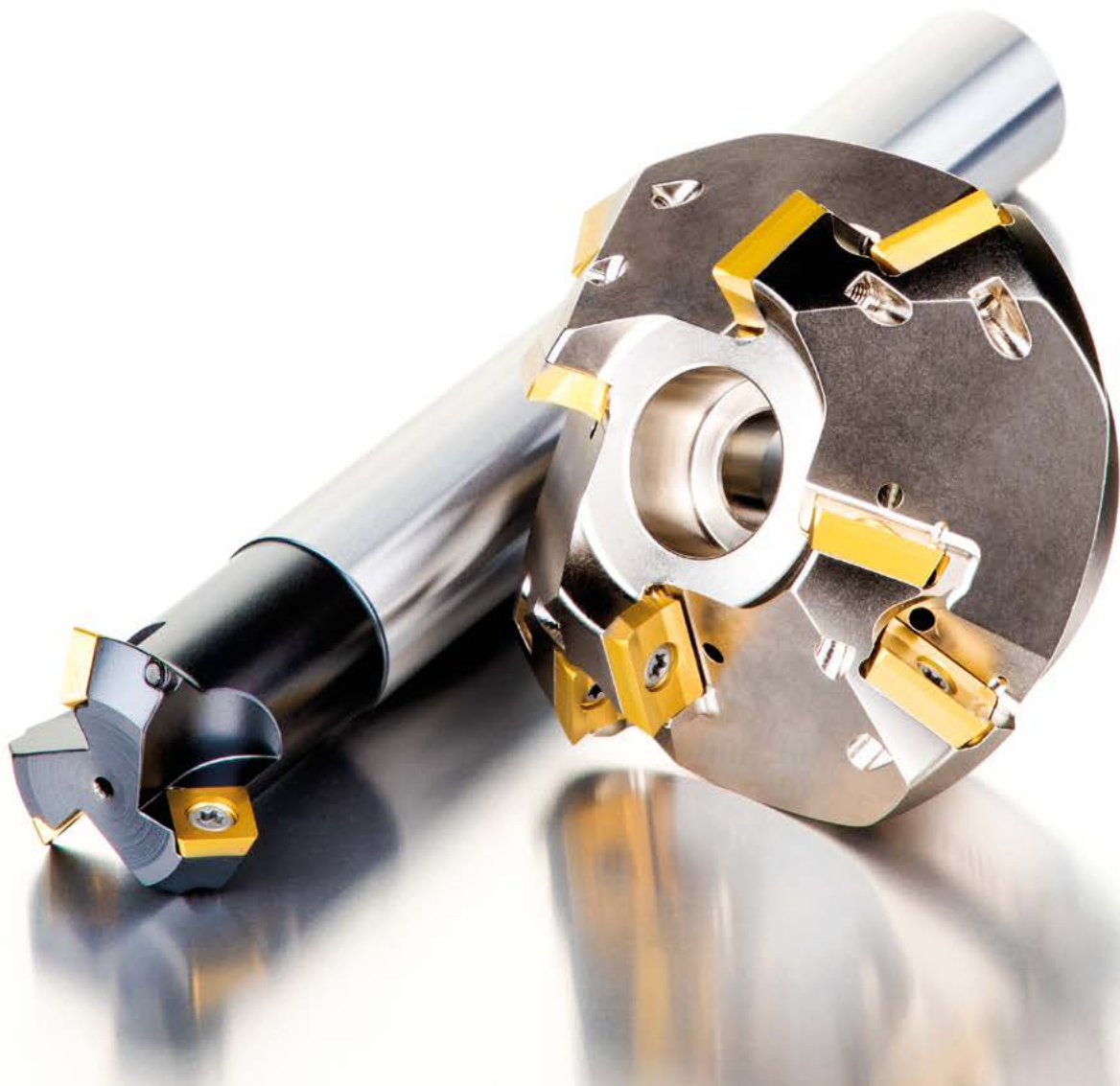

















INDEXABLE CHAMFER & T-SLOTS MILLS



INDEXABLE CHAMFER & T-SLOTS MILLS – NAVIGATOR

CHAMFER, T-SLOT MILLING









	SSD09		N-SS09		2516		2636		J(T)-SXP16								
	45°		45°		45°		10°–80°		15°–75°								
	APMX [mm]	4.5	APMX [mm]	4.5	APMX [mm]	8.5	APMX [mm]	8.5	APMX [mm]	7.0–28.0							
	DC [mm]	10–25	DC [mm]	8–25	DC [mm]	11–19	DC [mm]	5–23	DC [mm]	35–45							
Cylindrical shank																	
	DC = 16–25 [mm]																
Weldon																	
	DC = 10–25 [mm]																
Morse																	
	DC = 10–25 [mm]																
Shell mill																	
Page	648		651		654		657		660								
ISO	P	M	K	S	H	P	M	K	S	P	M	K	S	P	M	K	N
Insert shape																	
Inserts	SDE.0903		SOMT.09T3		TCMT.16T3		TCMT.16T3		XPHT.1604								
No. of cutting edges	4		4		3		3		2								
Chamfer milling 	■		■		■		■		■								
Rear face milling 																	
T-slot milling 																	
Shallow shoulder milling 																	
Shallow slot milling 																	



INDEXABLE CHAMFER & T-SLOTS MILLS – NAVIGATOR



CHAMFER, T-SLOT MILLING

F-SCC									
90°									
APMX [mm]	11.0 – 18.0								
DC [mm]	25 – 40								
									
664									
P	M	K							
									
CCMX									
2									
									
	■								
	■								
	▣								
	▣								



SSD09



PRAMET

S



45° Chamfer Milling Cutter for Square Insert SD.. 09

A 45° chamfer milling cutter utilising single-sided SD.. 09 inserts with APMX of 4.5 mm. Suitable for top and bottom side chamfering. Available in cylindrical, Weldon and Morse taper style and outside Ø22, Ø28 and Ø37 mm . Body treated for longer tool life.

KAPR	45°
APMX	4.5 mm

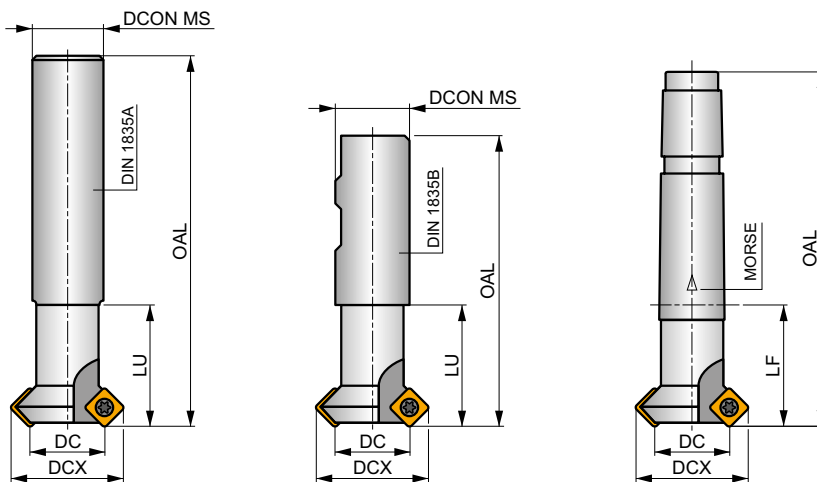
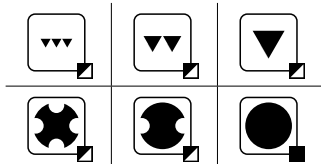
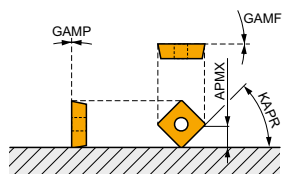

h_m 0.095 - 0.15



Product	DC	DCX	OAL	DCON MS	LU	LF	CZC MS	GAMF	GAMP						
	[mm]	[mm]	[mm]	[mm]	[mm]	[mm]		[°]	[°]				[kg]		
16N2R027A16-SSD09	16	28	200	16	27	-	-	0	0	2	-	32200	-	0.37	GI129 C0070
25N3R042A25-SSD09	25	37	200	25	42	-	-	0	0	3	-	25800	-	0.78	GI129 CH011
10N1R027B16-SSD09-A	10	22	75	16	27	-	-	0	0	1	-	40700	-	0.14	GI129 C0070
16N2R027B16-SSD09-A	16	28	75	16	27	-	-	0	0	2	-	32200	-	0.14	GI129 C0070
25N3R042B25-SSD09-A	25	37	98	25	42	-	-	0	0	3	-	25800	-	0.37	GI129 CH011
10N1R030E02-SSD09-A	10	22	94	-	-	30	2	0	0	1	-	40700	-	0.17	GI129 C0070
16N2R030E02-SSD09-A	16	28	94	-	-	30	2	0	0	2	-	32200	-	0.25	GI129 C0070
25N3R043E03-SSD09-A	25	37	124	-	-	43	3	0	0	3	-	25800	-	0.38	GI129 CH011

GI129	SDEW 0903..	SDEX 0903..

C0070	US 3507-T15	3.0	M 3.5	7	Flag T15
CH011	US 3509-T15	3.0	M 3.5	9	Flag T15



SDEW 09

	IC	D1	S
	[mm]	[mm]	[mm]
0903	9.525	4.40	3.18

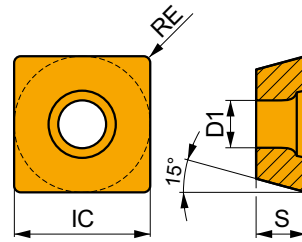

Suitability and starting values for cutting speed (vc), feed (f) and depth of cut (ap). Refer to our Machining Calculator app for further calculations.

Product	RE	P			M			K			N			S			H		
		vc	f	ap	vc	f	ap	vc	f	ap	vc	f	ap	vc	f	ap	vc	f	ap
	[mm]	[m/min]	[mm/tooth]	[mm]	[m/min]	[mm/tooth]	[mm]	[m/min]	[mm/tooth]	[mm]	[m/min]	[mm/tooth]	[mm]	[m/min]	[mm/tooth]	[mm]	[m/min]	[mm/tooth]	[mm]

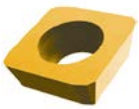

EN geometry with zero rake angle design for 45° chamfer milling.

SDEW 090308EN	M8330	0.8	235	0.10	4.5	–	–	–	220	0.10	4.5	–	–	–	–	–	–	–	45	0.15	1.0
	M8340	0.8	210	0.10	4.5	–	–	–	195	0.10	4.5	–	–	–	–	–	–	–	–	–	–



SN geometry with zero rake angle design for 45° chamfer milling.

SDEW 090308SN	8215	0.8	215	0.15	4.5	–	–	–	200	0.15	4.5	–	–	–	–	–	–	–	40	0.15	1.0
	M8330	0.8	215	0.15	4.5	–	–	–	200	0.15	4.5	–	–	–	–	–	–	–	40	0.15	1.0
	M8340	0.8	195	0.15	4.5	–	–	–	185	0.15	4.5	–	–	–	–	–	–	–	–	–	–

SDEX 09

	IC	D1	S
	[mm]	[mm]	[mm]
0903	9.525	4.40	3.18

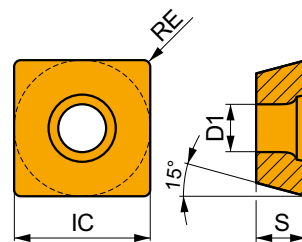

Suitability and starting values for cutting speed (vc), feed (f) and depth of cut (ap). Refer to our Machining Calculator app for further calculations.

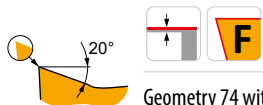

Product	RE	P			M			K			N			S			H		
		vc	f	ap	vc	f	ap	vc	f	ap	vc	f	ap	vc	f	ap	vc	f	ap
	[mm]	[m/min]	[mm/tooth]	[mm]	[m/min]	[mm/tooth]	[mm]	[m/min]	[mm/tooth]	[mm]	[m/min]	[mm/tooth]	[mm]	[m/min]	[mm/tooth]	[mm]	[m/min]	[mm/tooth]	[mm]







Geometry 74 with positive design for 45° chamfer milling.

SDEX 090308FN-74	M8330	0.8	305	0.12	4.5	180	0.11	4.5	285	0.12	4.5	–	–	–	75	0.11	3.6	–	–	–
-------------------------	--------------	-----	-----	------	-----	-----	------	-----	-----	------	-----	---	---	---	----	------	-----	---	---	---

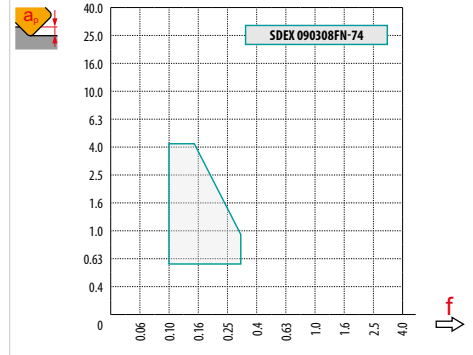
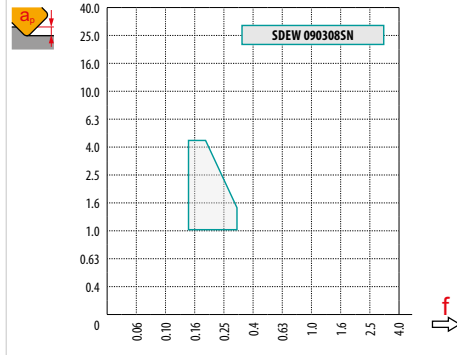
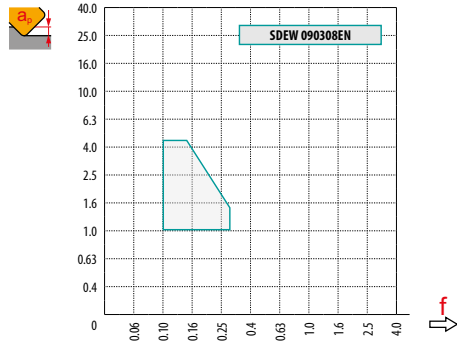



	SDEW 09 EN	SDEW 09 SN	SDEX 09-74
	0.8	0.8	0.8
	-	-	-



DC	DCX		f_{\min} 	f_{\max} 
10	22	1.09	0.20	0.30
16	28	1.17	0.25	0.34
25	37	1.24	0.32	0.39



a_b / DC	0.10	0.15	0.20	0.25	0.30	0.35	0.40	0.50 – 1.00																
	f 																							
45°	0.42	0.54	0.67	0.35	0.44	0.55	0.30	0.38	0.47	0.27	0.34	0.42	0.25	0.31	0.39	0.23	0.29	0.36	0.21	0.27	0.34	0.19	0.24	0.30
	1.35	1.27	1.22	1.19	1.16	1.13	1.11	1.00																



N-SS009

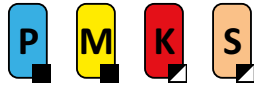

PRAMET



45° Chamfer Milling Cutter for Square Insert SOMT 09 with Internal Coolant

A 45° chamfer milling cutter utilising single-sided SOMT 09 inserts with APMX of 4.5 mm. Internal coolant. Suitable for top and bottom side chamfering. Available in cylindrical, Weldon and Morse taper style and outside Ø20.5, Ø28.8 and Ø37.8 mm. Body treated for longer tool life.

KAPR	45°
APMX	4.5 mm

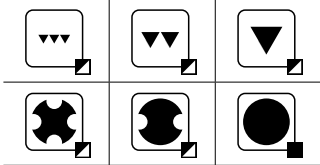
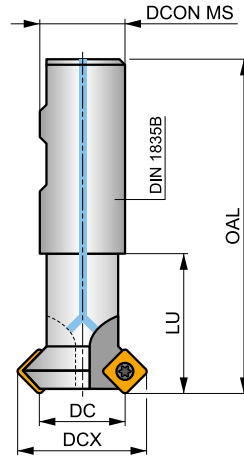
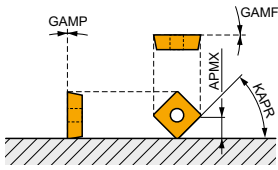

h_m 0.095 - 0.18



Product	DC	DCX	OAL	DCON MS	LU	GAMF	GAMP						
	[mm]	[mm]	[mm]	[mm]	[mm]	[°]	[°]			max.		kg	
16N2R027B16-SS009-C	16	28.8	110	16	27	0	0	2	—	26600	✓	0.23	G146 SQ500
25N3R042B25-SS009-C	25	37.8	125	25	42	0	0	3	—	21300	✓	0.50	G146 SQ500
8N1R027B16-SS009-C	8	20.5	90	16	27	0	0	1	—	37700	✓	0.12	G146 SQ500

	G146		SOMT 09T3..
--	------	--	-------------

	SQ500		US 3006-T09P		2.0		M 3		6		Flag T09P
--	-------	--	--------------	--	-----	--	-----	--	---	--	-----------



SOMT 09



	IC	D1	L	S
	[mm]	[mm]	[mm]	[mm]
09T3	9.550	3.50	9.55	3.97

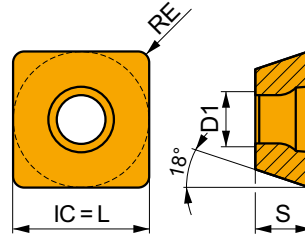

Suitability and starting values for cutting speed (vc), feed (f) and depth of cut (ap). Conditions are valid for setting angle 90°. Refer to our Machining Calculator app for further calculations.

Product	RE	P			M			K			N			S			H		
		vc	f	ap	vc	f	ap	vc	f	ap	vc	f	ap	vc	f	ap	vc	f	ap
	[mm]	[m/min]	[mm/tooth]	[mm]	[m/min]	[mm/tooth]	[mm]	[m/min]	[mm/tooth]	[mm]	[m/min]	[mm/tooth]	[mm]	[m/min]	[mm/tooth]	[mm]	[m/min]	[mm/tooth]	[mm]

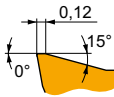
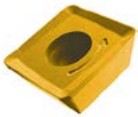

M geometry with positive design for medium machining.

SOMT 09T308-M	8215	0.8	275	0.14	2.5	165	0.13	2.5	260	0.14	2.5	65	0.13	2.0			
	M5315	0.8	390	0.14	2.5	—	—	—	370	0.14	2.5	—	—	—	—	—	—
	M8330	0.8	270	0.14	2.5	160	0.13	2.5	255	0.14	2.5	65	0.13	2.0	—	—	—
	M8340	0.8	250	0.14	2.5	150	0.13	2.5	235	0.14	2.5	60	0.13	2.0	—	—	—
	M9315	0.8	380	0.14	2.5	—	—	—	360	0.14	2.5	—	—	—	—	—	—

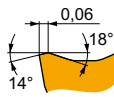
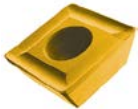

MI geometry with stable positive design for medium machining.

SOMT 09T304-MI	8215	0.4	230	0.14	2.5	135	0.13	2.5	215	0.14	2.5	55	0.10	2.0	—	—	—
	M8310	0.4	255	0.14	2.5	130	0.13	2.5	240	0.14	2.5	—	—	—	—	—	—
	M8330	0.4	230	0.14	2.5	135	0.13	2.5	215	0.14	2.5	55	0.10	2.0	—	—	—
	M8340	0.4	210	0.14	2.5	125	0.13	2.5	195	0.14	2.5	50	0.10	2.0	—	—	—
	M9315	0.4	320	0.14	2.5	—	—	—	300	0.14	2.5	—	—	—	—	—	—
	M9340	0.4	265	0.14	2.5	155	0.13	2.5	—	—	—	65	0.10	2.0	—	—	—

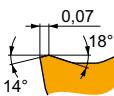
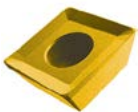

P geometry with highly positive design for medium machining.

SOMT 09T304-P	M8330	0.4	250	0.14	2.5	150	0.13	2.5	235	0.14	2.5	60	0.10	2.0	—	—	—
	M8340	0.4	230	0.14	2.5	135	0.13	2.5	215	0.14	2.5	55	0.10	2.0	—	—	—
	M9325	0.4	320	0.14	2.5	—	—	—	300	0.14	2.5	—	—	—	—	—	—



	SOMT 09-M	SOMT 09-MI	SOMT 09-P
	0.8	0.4	0.4
	-	-	-

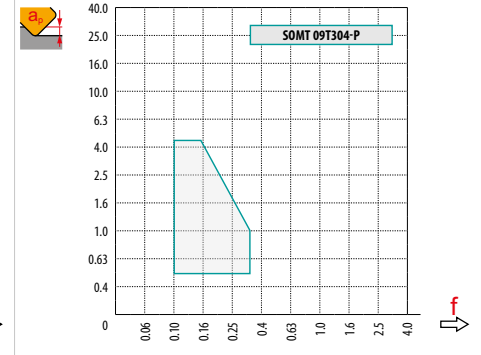
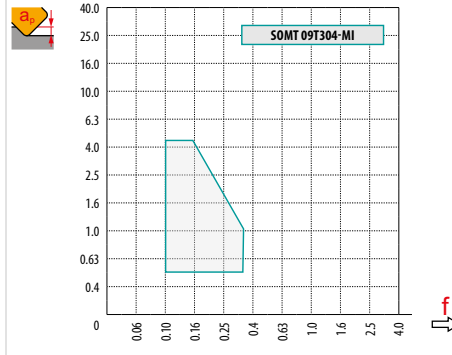
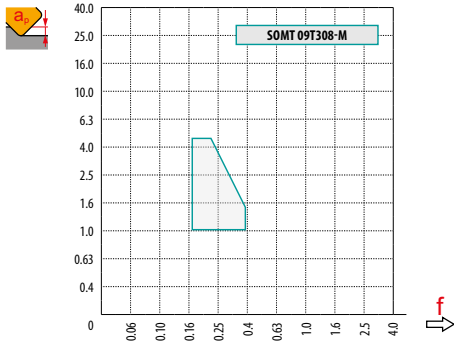

DC	DCX		f_{min}	f_{max}
8	20.5	1.06	0.18	0.29
16	28.8	1.17	0.25	0.34
25	37.8	1.24	0.32	0.39



a_s / DC	0.10		0.15		0.20		0.25		0.30		0.35		0.40		0.50 – 1.00									
	f																							
45°	0.42	0.63	0.80	0.35	0.51	0.66	0.30	0.44	0.57	0.27	0.40	0.51	0.25	0.36	0.46	0.23	0.33	0.43	0.21	0.31	0.40	0.19	0.28	0.36
	1.35		1.27		1.22		1.19		1.16		1.13		1.11		1.00									



2516



PRAMET

S



KAPR	45°
APMX	8,5 mm

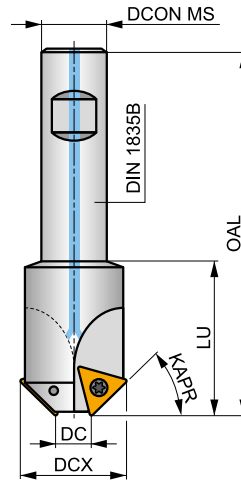
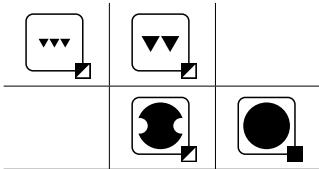
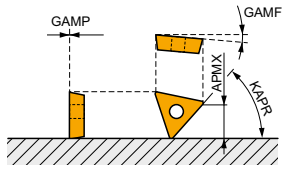

h_m 0.065 - 0.095



	DCX	DC	OAL	DCON MS	LU							
	[mm]	[mm]	[mm]	[mm]	[mm]			max.		kg		
2516-45-11	31	11	100	16	30	2	-	18100	✓	0.24	GI155	SQ220
2516-45-19	39	19	100	20	30	2	-	16200	✓	0.35	GI155	SQ220

	GI155		TCMT 16T308E-FM:T83..
--	-------	--	-----------------------

SQ220	US 4011-T15P	3.5	M 4	10.6	Flag T15P



TCMT

	IC	D1	L	S
	[mm]	[mm]	[mm]	[mm]
16T3	9.525	4.4	16.5	3.97

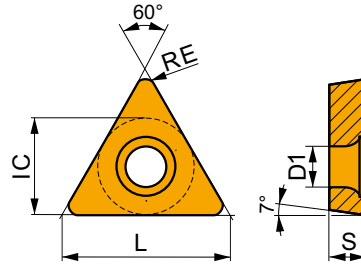

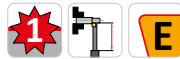
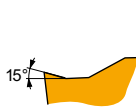

RE	P			M			K			N			S			H		
	vc	f	ap	vc	f	ap	vc	f	ap	vc	f	ap	vc	f	ap	vc	f	ap
[mm]	[m/min]	[mm/rev]	[mm]	[m/min]	[mm/rev]	[mm]	[m/min]	[mm/rev]	[mm]	[m/min]	[mm/rev]	[mm]	[m/min]	[mm/rev]	[mm]	[m/min]	[mm/rev]	[mm]



TCMT 16T308E-FM		0.80	P			M			K			N			S			H		
			vc	f	ap	vc	f	ap	vc	f	ap	vc	f	ap	vc	f	ap	vc	f	ap
T8315	0.80	170	0.17	1.7	100	0.15	1.7	160	0.17	1.7	510	0.20	1.7	-	-	-	-	-	-	
T8330	0.80	160	0.17	1.7	95	0.15	1.7	150	0.17	1.7	480	0.20	1.7	-	-	-	-	-	-	



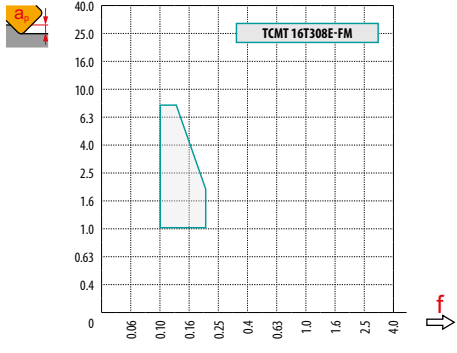

	TCMT 16-FM
	0.8
	-



DC	DCX		f_{min}	f_{max}
11.0	31.0	1.02	0.10	0.18
19.0	39.0	1.10	0.14	0.20



a_e / DC	0.10		0.15		0.20		0.25		0.30		0.35		0.40		0.50 - 1.00									
	f																							
45°	0.29	0.34	0.42	0.24	0.27	0.35	0.21	0.24	0.30	0.18	0.21	0.27	0.17	0.19	0.25	0.16	0.18	0.23	0.15	0.17	0.21	0.13	0.15	0.19
	1.35		1.27		1.22		1.19		1.16		1.13		1.11		1.00									



2636

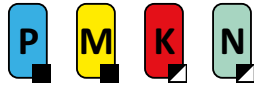

PRAMET



Adjustable Milling Cutter for TCMT 16 insert

Adjustable chamfering milling cutter utilising TCMT 16 inserts with APMX of 8.5 mm. Adjustable angle range from 10° up to 80°. Available in Weldon style Ø25 mm only. Body treated for longer tool life.

KAPR	10°- 80°
APMX	8,5 mm

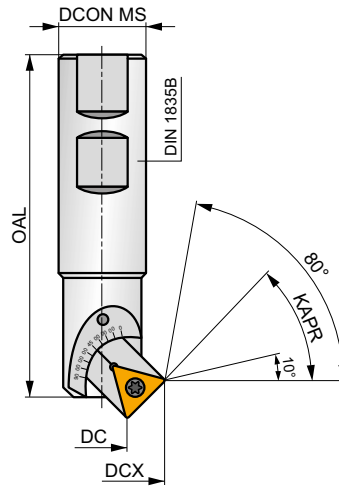
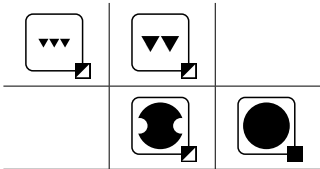
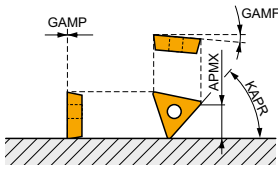

h_m 0.03 - 0.08



Product	DC	DCX	OAL	DCON MS	KAPR	GAMF	GAMP							
	[mm]	[mm]	[mm]	[mm]	[°]	[°]	[°]							
2636-05-25	5.0	31.0			10									
	5.5	31.0			15									
	7.0	29.5			30									
	11.0	29.5	100	25	45	-8	0	1	-	18100	-	0.35	GI294	CH040
	16.0	28.5			60									
	21.0	26.5			75									
	23.0	26.0			80									

GI294	TCMT 16T304E-FM:T83..	TCMT 16T308E-FM:T83..

CH040	USI 0614	CA 2669	US 4011-T15P	3.5	M 4	10.6	Flag T15



TCMT

	IC	D1	L	S
	[mm]	[mm]	[mm]	[mm]
16T3	9.525	4.4	16.5	3.97

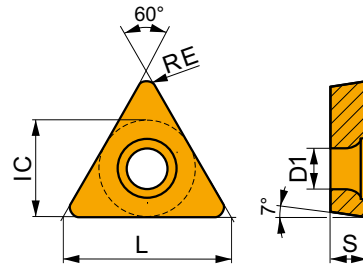

Suitability and starting values for cutting speed (vc), feed (f) and depth of cut (ap). Refer to our Machining Calculator app for further calculations.

Product	RE [mm]	P			M			K			N			S			H		
		vc [m/min]	f [mm/rev]	ap [mm]	vc [m/min]	f [mm/rev]	ap [mm]	vc [m/min]	f [mm/rev]	ap [mm]	vc [m/min]	f [mm/rev]	ap [mm]	vc [m/min]	f [mm/rev]	ap [mm]	vc [m/min]	f [mm/rev]	ap [mm]

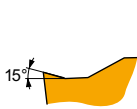
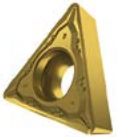

FM geometry for finish to semi-rough machining, continuous to slightly interrupted cuts.

TCMT 16T304E-FM	T8315	0.40	✓	155	0.12	1.7	■	90	0.11	1.7	✓	145	0.12	1.7	✓	465	0.14	1.7	—	—	—	—	—	—
	T8330	0.40	■	150	0.12	1.7	■	90	0.11	1.7	✓	140	0.12	1.7	✓	450	0.14	1.7	—	—	—	—	—	—
TCMT 16T308E-FM	T8315	0.80	✓	170	0.17	1.7	■	100	0.15	1.7	✓	160	0.17	1.7	✓	510	0.20	1.7	—	—	—	—	—	—
	T8330	0.80	■	160	0.17	1.7	■	95	0.15	1.7	✓	150	0.17	1.7	✓	480	0.20	1.7	—	—	—	—	—	—



TCMT 16-FM		
	0.8	0.4
	-	-

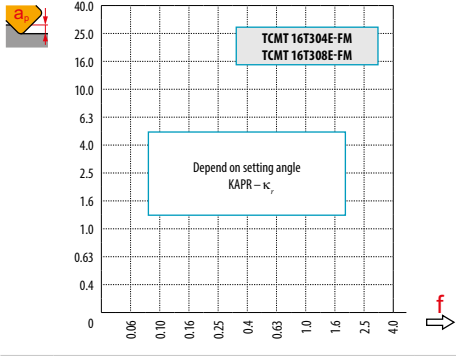

		DC	DCX		f_{min}	f_{max}
10°	2.6	5.0	31.0	1.38	0.24	0.59
15°	3.9	5.5	31.0	1.30	0.17	0.40
30°	7.6	7.0	29.5	1.18	0.10	0.20
45°	10.7	11.0	29.5	1.13	0.09	0.14
60°	13.2	16.0	28.5	1.09	0.09	0.11
75°	14.7	21.0	26.5	1.06	0.09	0.10
80°	15.0	23.0	26.0	1.06	0.09	0.10



a_e / DC	0.10	0.15	0.20	0.25	0.30	0.35	0.40	0.50 - 1.00																
	f																							
10°	0.55	0.91	1.46	0.45	0.74	1.19	0.39	0.64	1.03	0.35	0.58	0.92	0.32	0.53	0.84	0.29	0.49	0.78	0.27	0.46	0.73	0.24	0.41	0.65
15°	0.37	0.61	0.98	0.30	0.50	0.80	0.26	0.43	0.69	0.23	0.39	0.62	0.21	0.35	0.56	0.20	0.33	0.52	0.18	0.31	0.49	0.16	0.27	0.44
30°	0.19	0.32	0.51	0.15	0.26	0.41	0.13	0.22	0.36	0.12	0.20	0.32	0.11	0.18	0.29	0.10	0.17	0.27	0.09	0.16	0.25	0.08	0.14	0.23
45°	0.13	0.22	0.36	0.11	0.18	0.29	0.09	0.16	0.25	0.08	0.14	0.23	0.08	0.13	0.21	0.07	0.12	0.19	0.07	0.11	0.18	0.06	0.10	0.16
60°	0.11	0.18	0.29	0.09	0.15	0.24	0.08	0.13	0.21	0.07	0.12	0.18	0.06	0.11	0.17	0.06	0.10	0.16	0.05	0.09	0.15	0.05	0.08	0.13
75°	0.10	0.16	0.26	0.08	0.13	0.21	0.07	0.12	0.19	0.06	0.10	0.17	0.06	0.09	0.15	0.05	0.09	0.14	0.05	0.08	0.13	0.04	0.07	0.12
80°	0.10	0.16	0.26	0.08	0.13	0.21	0.07	0.11	0.18	0.06	0.10	0.16	0.06	0.09	0.15	0.05	0.09	0.14	0.05	0.08	0.13	0.04	0.07	0.11
	1.35		1.27		1.22		1.19		1.16		1.13		1.11		1.00									



J(T)-SXP16



PRAMET

S



Long Edge Chamfer Milling Cutter for XPHT 16 insert with Internal Coolant

Chamfer milling cutter utilising single-sided XPHT 16 inserts with APMX from 7 up to 28 mm. Internal coolant. Suitable for top chamfering. Available in arbor style only. Minor Ø35 and Ø45 mm, in range of 15°, 25°, 30°, 35°, 40°, 45°, 50°, 55°, 60° and 75° chamfer angle. Body treated for longer tool life.

KAPR	15° - 75°
APMX	7.0 - 28.0 mm

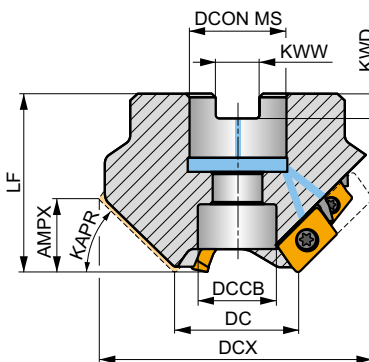
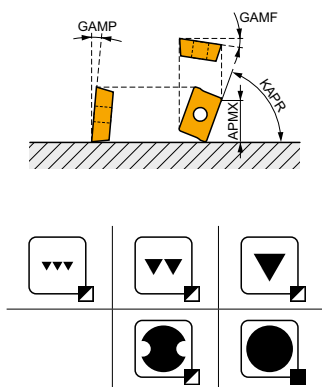

0.05 - 0.11



Product	DC	DCX	LF	DCON MS	DCCB	KAPR	KWW	KWD	APMX	GAMF	GAMP	NOF							
	[mm]	[mm]	[mm]	[mm]	[mm]	[°]	[mm]	[mm]	[mm]	[°]	[°]			max.	[kg]				
35T03R-S15XP1607-C	35	90.6	50	27	22	15	12.4	7	7.00	-6	-1	3	6	-	15200	✓	1.38	GI208	CH050
35T03R-S25XP1612-C	35	87.3	50	27	22	25	12.4	7	12.00	-6	0	3	6	-	15200	✓	1.24	GI208	CH050
35T03R-S30XP1614-C	35	85.1	50	27	22	30	12.4	7	14.00	-6	0	3	6	-	15200	✓	1.28	GI208	CH050
35T03R-S35XP1616-C	35	82.4	50	27	22	35	12.4	7	16.00	-6	0	3	6	-	15200	✓	1.15	GI208	CH050
35T03R-S40XP1618-C	35	79.4	50	27	22	40	12.4	7	18.00	-6	1	3	6	-	15200	✓	1.07	GI208	CH050
35T03R-S45XP1620-C	35	76.1	50	27	22	45	12.4	7	20.00	-6	2	3	6	-	15200	✓	0.97	GI208	CH050
35T03R-S50XP1622-C	35	72.4	50	27	22	50	12.4	7	22.00	-6	2	3	6	-	15200	✓	0.91	GI208	CH050
35T03R-S55XP1623-C	35	68.4	50	27	22	55	12.4	7	23.00	-6	2	3	6	-	15200	✓	0.83	GI208	CH050
35T03R-S60XP1625-C	35	64.2	50	27	22	60	12.4	7	25.00	-5	4	3	6	-	15200	✓	0.67	GI208	CH050
45T03R-S75XP1628-C	45	60.1	50	27	22	75	12.4	7	28.00	-5	5	3	6	-	13400	✓	0.73	GI208	CH050
45T04R-S25XP1612-C	45	97.3	50	27	22	25	12.4	7	12.00	-6	0	4	8	✓	13400	✓	1.63	GI208	CH050
45T04R-S30XP1614-C	45	95.1	50	27	22	30	12.4	7	14.00	-6	0	4	8	✓	13400	✓	1.22	GI208	CH050
45T04R-S35XP1616-C	45	92.4	50	27	22	35	12.4	7	16.00	-6	2	4	8	✓	13400	✓	1.30	GI208	CH050
45T04R-S40XP1618-C	45	89.5	50	27	22	40	12.4	7	18.00	-6	2	4	8	✓	13400	✓	1.18	GI208	CH050
45T04R-S45XP1620-C	45	86.1	50	27	22	45	12.4	7	20.00	-6	2	4	8	✓	13400	✓	1.11	GI208	CH050
45T04R-S50XP1622-C	45	82.4	50	27	22	50	12.4	7	22.00	-6	2	4	8	✓	13400	✓	1.04	GI208	CH050
45T04R-S55XP1623-C	45	78.4	50	27	22	55	12.4	7	23.00	-6	2	4	8	✓	13400	✓	0.96	GI208	CH050
45T04R-S60XP1625-C	45	74.2	50	27	22	60	12.4	7	25.00	-5	4	4	8	✓	13400	✓	0.82	GI208	CH050



GI208



XPHT 1604..



CH050



US 3509-T15



3.0



M 3.5



9



D-T07/T15



FG-15



HS 1230C



XPHT 16

	W1	D1	L	S
	[mm]	[mm]	[mm]	[mm]
1604	9.525	4.40	15.88	4.76

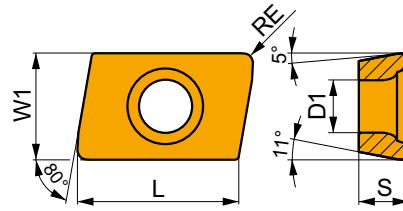

Suitability and starting values for cutting speed (vc), feed (f) and depth of cut (ap). Refer to our Machining Calculator app for further calculations.

Product	RE	P			M			K			N			S			H		
		vc	f	ap	vc	f	ap	vc	f	ap	vc	f	ap	vc	f	ap	vc	f	ap
	[mm]	[m/min]	[mm/tooth]	[mm]	[m/min]	[mm/tooth]	[mm]	[m/min]	[mm/tooth]	[mm]	[m/min]	[mm/tooth]	[mm]	[m/min]	[mm/tooth]	[mm]	[m/min]	[mm/tooth]	[mm]

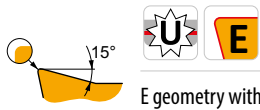

E geometry with highly positive design for chamfer milling.

XPHT 160412E	8215	1.2	225	0.10	15.0	135	0.09	15.0	210	0.10	15.0	-	-	-	-	-	-	-	-
	M6330	1.2	190	0.10	15.0	135	0.09	15.0	-	-	-	-	-	-	-	-	-	-	-
	M8330	1.2	220	0.10	15.0	130	0.09	15.0	205	0.10	15.0	-	-	-	-	-	-	-	-
	M8340	1.2	195	0.10	15.0	115	0.09	15.0	185	0.10	15.0	-	-	-	-	-	-	-	-

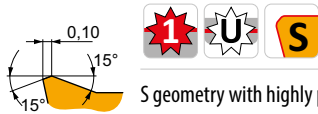

S geometry with highly positive design for chamfer milling.

XPHT 160412S	8215	1.2	210	0.12	15.0	125	0.11	15.0	195	0.12	15.0	-	-	-	-	-	-	-	-
	M8330	1.2	210	0.12	15.0	125	0.11	15.0	195	0.12	15.0	-	-	-	-	-	-	-	-
	M8340	1.2	190	0.12	15.0	110	0.11	15.0	180	0.12	15.0	-	-	-	-	-	-	-	-
	M9325	1.2	270	0.12	15.0	-	-	-	255	0.12	15.0	-	-	-	-	-	-	-	-
	M9340	1.2	245	0.12	15.0	145	0.11	15.0	-	-	-	-	-	-	-	-	-	-	-



XPHT 16-FA

	W1	D1	L	S
	[mm]	[mm]	[mm]	[mm]
1604	9.525	4.40	15.88	4.76

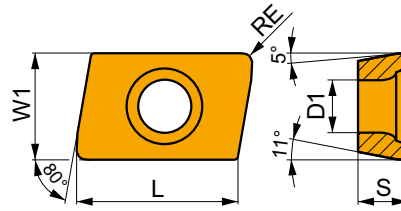

Suitability and starting values for cutting speed (vc), feed (f) and depth of cut (ap). Refer to our Machining Calculator app for further calculations.

Product	RE [mm]	P			M			K			N			S			H		
		vc [m/min]	f [mm/tooth]	ap [mm]	vc [m/min]	f [mm/tooth]	ap [mm]	vc [m/min]	f [mm/tooth]	ap [mm]	vc [m/min]	f [mm/tooth]	ap [mm]	vc [m/min]	f [mm/tooth]	ap [mm]	vc [m/min]	f [mm/tooth]	ap [mm]

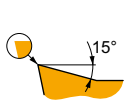

FA geometry with highly positive design for chamfer milling.

XPHT 160408F-FA	HF7	0.8	-	-	-	-	-	-	-	255	0.12	15.0	-	-	-	-	-	-
-----------------	-----	-----	---	---	---	---	---	---	---	-----	------	------	---	---	---	---	---	---



	XPHT 16 E	XPHT 16 S	XPHT 16-FA
	1.2	1.2	0.8
	-	-	-

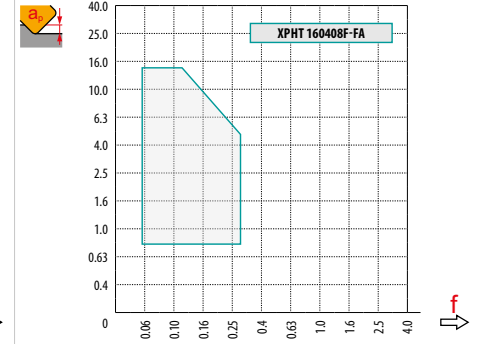
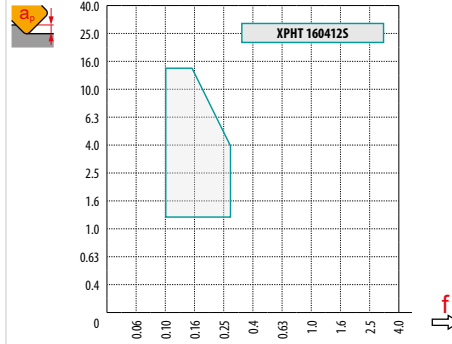
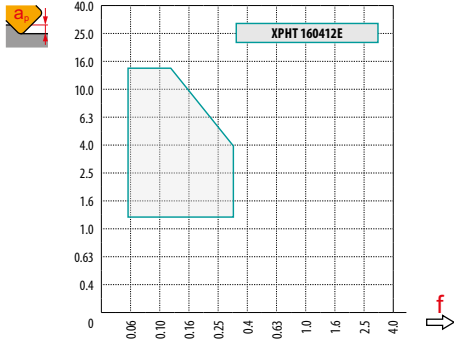

a_e / DC	0.10		0.15		0.20		0.25		0.30		0.35		0.40		0.50 - 1.00									
	f																							
15°	0.61	0.98	1.34	0.50	0.80	1.10	0.43	0.69	0.95	0.39	0.62	0.85	0.35	0.56	0.78	0.33	0.52	0.72	0.31	0.49	0.67	0.27	0.44	0.60
25°	0.37	0.60	0.82	0.31	0.49	0.67	0.26	0.42	0.58	0.24	0.38	0.52	0.22	0.35	0.48	0.20	0.32	0.44	0.19	0.30	0.41	0.17	0.27	0.37
30°	0.32	0.51	0.70	0.26	0.41	0.57	0.22	0.36	0.49	0.20	0.32	0.44	0.18	0.29	0.40	0.17	0.27	0.37	0.16	0.25	0.35	0.14	0.23	0.31
35°	0.28	0.44	0.61	0.23	0.36	0.50	0.19	0.31	0.43	0.17	0.28	0.38	0.16	0.25	0.35	0.15	0.24	0.32	0.14	0.22	0.30	0.12	0.20	0.27
40°	0.25	0.39	0.54	0.20	0.32	0.44	0.17	0.28	0.38	0.16	0.25	0.34	0.14	0.23	0.31	0.13	0.21	0.29	0.12	0.20	0.27	0.11	0.18	0.24
45°	0.22	0.36	0.49	0.18	0.29	0.40	0.16	0.25	0.35	0.14	0.23	0.31	0.13	0.21	0.28	0.12	0.19	0.26	0.11	0.18	0.25	0.10	0.16	0.22
50°	0.21	0.33	0.45	0.17	0.27	0.37	0.15	0.23	0.32	0.13	0.21	0.29	0.12	0.19	0.26	0.11	0.18	0.24	0.10	0.17	0.23	0.10	0.15	0.20
55°	0.19	0.31	0.42	0.16	0.25	0.35	0.14	0.22	0.30	0.12	0.20	0.27	0.11	0.18	0.25	0.10	0.17	0.23	0.10	0.15	0.21	0.09	0.14	0.19
60°	0.18	0.29	0.40	0.15	0.24	0.33	0.13	0.21	0.28	0.12	0.18	0.25	0.11	0.17	0.23	0.10	0.16	0.21	0.09	0.15	0.20	0.08	0.13	0.18
75°	0.16	0.26	0.36	0.13	0.21	0.29	0.12	0.19	0.25	0.10	0.17	0.23	0.09	0.15	0.21	0.09	0.14	0.19	0.08	0.13	0.18	0.07	0.12	0.16
	1.35		1.27		1.22		1.19		1.16		1.13		1.11		1.00									



		DC	DCX		f_{min}	f_{max}
15°	7	35.0	90.6	1.16	0.43	0.70
25°	12	35.0	87.3	1.16	0.20	0.32
30°	14	35.0	85.1	1.17	0.16	0.25
35°	16	35.0	82.4	1.17	0.13	0.20
40°	18	35.0	79.4	1.17	0.11	0.16
45°	20	35.0	76.0	1.18	0.09	0.14
50°	22	35.0	72.4	1.18	0.08	0.12
55°	23	35.0	68.4	1.20	0.08	0.11
60°	25	35.0	64.1	1.20	0.07	0.09
25°	12	45.0	97.3	1.18	0.23	0.34
30°	14	45.0	95.0	1.18	0.18	0.26
35°	16	45.0	92.4	1.19	0.15	0.21
40°	18	45.0	89.5	1.19	0.12	0.17
45°	20	45.0	86.0	1.20	0.11	0.15
50°	22	45.0	82.4	1.21	0.09	0.13

		DC	DCX		f_{min}	f_{max}
55°	23	45.0	78.4	1.22	0.09	0.11
60°	25	45.0	74.1	1.23	0.08	0.10
75°	28	45.0	60.1	1.31	0.07	0.08

Cutters with setting angle 15° can be used as HFC. Use feeds from chamfers table.



F-SCC

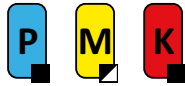

PRAMET

S



T-Slot Milling Cutter for CCMX insert with Internal Coolant

T-slot milling cutter utilising single-sided CCMX inserts. Internal coolant. Suitable for T-slot, back-face, shallow shoulder and shallow slot milling. Available in Weldon style only in outside Ø25, Ø32 and Ø40 mm. Body treated for longer tool life.

KAPR	90°
APMX	11.0 - 18.0 mm

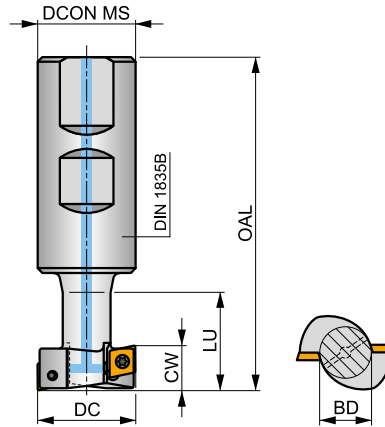
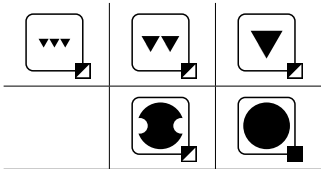
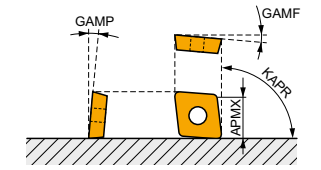

h_m 0.05 - 0.08



Product	DC	BD	OAL	DCON MS	LU	CW	$\frac{x}{1}$					kg		
	[mm]	[mm]	[mm]	[mm]	[mm]	[mm]								
25F1R030B25-SCC06-C	25	12	86	25	25	11.00	1	2	-	28100	✓	0.26	GI148	SQ213
32F1R038B32-SCC08-C	32	16	98	32	33	14.00	1	2	-	19100	✓	0.50	GI149	SQ212
40F2R046B32-SCC09-C	40	20	105	32	41	18.00	2	4	-	14900	✓	0.56	GI150	SQ212

GI148	CCMX 060304
GI149	CCMX 08T308
GI150	CCMX 09T308

SQ212	US 3007-T09P	2.0	M 3	7.3	Flag T09P
SQ213	US 2506-T07P	1.2	M 2.5	6.3	Flag T07P



CCMX



	IC	D1	L	S
	[mm]	[mm]	[mm]	[mm]
0603	6.350	2.80	6.40	3.50
08T3	8.030	3.50	8.10	4.40
09T3	9.525	3.50	9.70	3.97

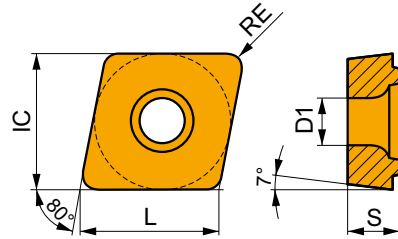

Suitability and starting values for cutting speed (vc), feed (f) and depth of cut (ap). Refer to our Machining Calculator app for further calculations.

Product	RE [mm]	P			M			K			N			S			H		
		vc [m/min]	f [mm/tooth]	ap [mm]	vc [m/min]	f [mm/tooth]	ap [mm]	vc [m/min]	f [mm/tooth]	ap [mm]	vc [m/min]	f [mm/tooth]	ap [mm]	vc [m/min]	f [mm/tooth]	ap [mm]			

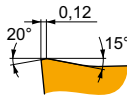

Special design for T-Slot milling fo+1250r light to medium cutting conditions.

CCMX 060304S-TS1	M8330	0.4	240	0.10	—	140	0.09	—	225	0.10	—	—	—	—	—	—	—	—
	M8340	0.4	215	0.10	—	125	0.09	—	200	0.10	—	—	—	—	—	—	—	—
CCMX 08T308S-TS1	M8330	0.8	275	0.10	—	165	0.10	—	260	0.10	—	—	—	—	—	—	—	—
	M8340	0.8	245	0.10	—	145	0.10	—	230	0.10	—	—	—	—	—	—	—	—
CCMX 09T308S-TS1	M8330	0.8	270	0.10	—	160	0.10	—	255	0.10	—	—	—	—	—	—	—	—
	M8340	0.8	240	0.10	—	140	0.10	—	225	0.10	—	—	—	—	—	—	—	—



	CCMX 06-TS1	CCMX 08-TS1	CCMX 09-TS1
	0.4	0.8	0.8
	-	-	-

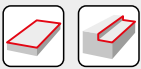
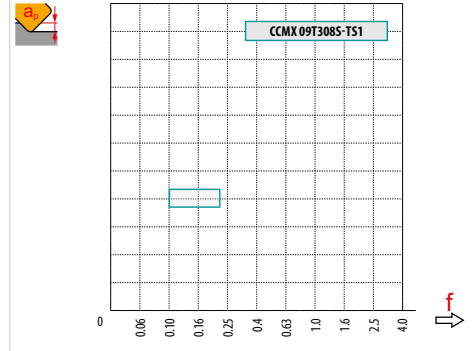
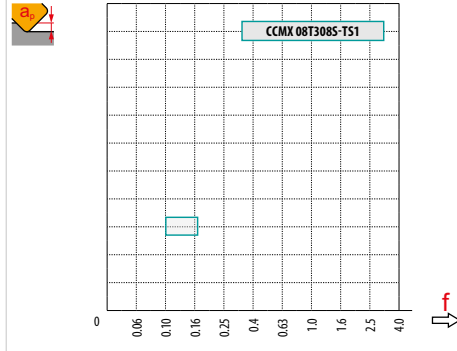
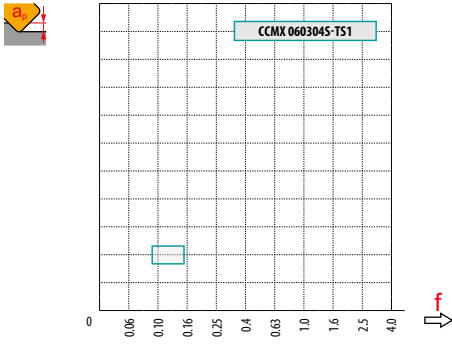

a_e / DC	5 %	10 %	15 %	20 %	25 %	30 %	40 %	50 %	60 %	70 %	75 %	80 %	90 %	100 %
	1.48	1.35	1.27	1.22	1.19	1.16	1.11	1.08	1.05	1.03	1.00	1.00	1.00	1.00



	$a_e = 1$		$a_e = 2$		$a_e = 3$		$a_e = 4$		$a_e = 5$		$a_e = 8$		$a_e = 10$	
	f_{min}	f_{max}	f_{min}	f_{max}	f_{min}	f_{max}	f_{min}	f_{max}	f_{min}	f_{max}	f_{min}	f_{max}	f_{min}	f_{max}
25	0.25	0.40	0.18	0.29	0.15	0.24	0.13	0.21	0.12	0.19	0.09	0.15	0.09	0.14
32	0.28	0.45	0.20	0.32	0.17	0.27	0.14	0.23	0.13	0.21	0.10	0.17	0.09	0.15
40	0.32	0.51	0.23	0.36	0.18	0.30	0.16	0.26	0.14	0.23	0.12	0.19	0.10	0.17

	$a_e = 12$		$a_e = 16$		$a_e = 20$		$a_e = 25$		$a_e = 32$		$a_e = 40$	
	f_{min}	f_{max}	f_{min}	f_{max}	f_{min}	f_{max}	f_{min}	f_{max}	f_{min}	f_{max}	f_{min}	f_{max}
25	0.08	0.13	0.07	0.12	0.07	0.11	0.08	0.13	-	-	-	-
32	0.09	0.14	0.08	0.13	0.07	0.12	0.07	0.11	0.08	0.13	-	-
40	0.10	0.15	0.09	0.14	0.08	0.13	0.07	0.12	0.07	0.11	0.08	0.13

- Valid for T-slot milling
- Valid for shoulder and inverse face milling
- Valid for shoulder milling

























25	1	11	6.4
32	1	14	8.0
40	2	18	9.7



OTHER MILLING INSERTS

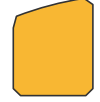

OTHER MILLING INSERTS – NAVIGATOR

ADKT 15  670	ADKX 15  670	APMT 16  671	CNM  672	ODMT 05  672
OFKR 07  673	RDET  673	RDEX  674	RDHX 20  674	RPET 12  675
RPEW 12  675	RPEX  676	SEEN  676	SEER  677	SEET 12  678
SEET 12-FA  678	SEET 12-PM  679	SEEW 12  679	SFCN  680	SNHF  680
SNHN  681	SNKX  681	SNUN  682	SPGN  682	SPGN 25 DZ  683
SPKN  683	SPKR  684	SPKX  685	SPUN  685	TNJF  686
TPCN 16  687	TPKN  687	TPKR  688	TPUN  689	VCGT 22-FA  690



XDHW



 690



ADKT 15

PRAMET

	W1	D1	L	S
	[mm]	[mm]	[mm]	[mm]
1505	9.525	4.40	15.55	5.60

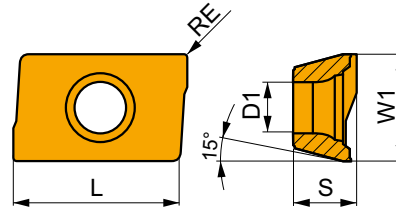

Suitability and starting values for cutting speed (vc), feed (f) and depth of cut (ap). Refer to our Machining Calculator app for further calculations.

Product	RE	P			M			K			N			S			H		
		vc	f	ap	vc	f	ap	vc	f	ap	vc	f	ap	vc	f	ap	vc	f	ap
	[mm]	[m/min]	[mm/tooth]	[mm]	[m/min]	[mm/tooth]	[mm]	[m/min]	[mm/tooth]	[mm]	[m/min]	[mm/tooth]	[mm]	[m/min]	[mm/tooth]	[mm]	[m/min]	[mm/tooth]	[mm]

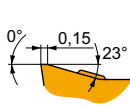

M geometry with highly positive design for medium machining.

ADKT 1505PDER-M	M8330	0.8	235	0.20	5.0	140	0.18	5.0	220	0.20	5.0	-	-	-	55	0.16	4.0	-	-	-
	M8340	0.8	210	0.20	5.0	125	0.18	5.0	195	0.20	5.0	-	-	-	50	0.16	4.0	-	-	-
	M9325	0.8	290	0.20	5.0	-	-	-	275	0.20	5.0	-	-	-	-	-	-	-	-	-

ADKX 15

PRAMET

	W1	L	S
	[mm]	[mm]	[mm]
15T3	9.525	12.60	3.97

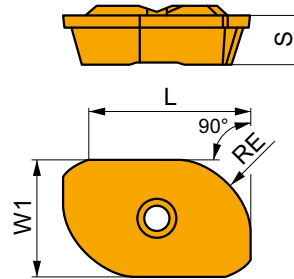

Suitability and starting values for cutting speed (vc), feed (f) and depth of cut (ap). Refer to our Machining Calculator app for further calculations.

Product	RE	P			M			K			N			S			H		
		vc	f	ap	vc	f	ap	vc	f	ap	vc	f	ap	vc	f	ap	vc	f	ap
	[mm]	[m/min]	[mm/tooth]	[mm]	[m/min]	[mm/tooth]	[mm]	[m/min]	[mm/tooth]	[mm]	[m/min]	[mm/tooth]	[mm]	[m/min]	[mm/tooth]	[mm]	[m/min]	[mm/tooth]	[mm]



F geometry with very sharp positive design for light to medium machining.

ADKX 15T308ER-F	M8330	0.8	245	0.10	10.0	145	0.09	10.0	-	-	-	-	-	-	60	0.07	8.0	-	-	-
	M8345	0.8	170	0.10	10.0	100	0.09	10.0	-	-	-	-	-	-	40	0.07	8.0	-	-	-
ADKX 15T330ER-F	M8330	3.0	280	0.10	10.0	165	0.09	10.0	-	-	-	-	-	-	70	0.07	8.0	-	-	-
	M8345	3.0	200	0.10	10.0	120	0.09	10.0	-	-	-	-	-	-	50	0.07	8.0	-	-	-
ADKX 15T340ER-F	M8330	4.0	280	0.10	10.0	165	0.09	10.0	-	-	-	-	-	-	70	0.07	8.0	-	-	-
	M8345	4.0	200	0.10	10.0	120	0.09	10.0	-	-	-	-	-	-	50	0.07	8.0	-	-	-
ADKX 15T360ER-F	M8330	6.0	280	0.10	10.0	165	0.09	10.0	-	-	-	-	-	-	70	0.07	8.0	-	-	-







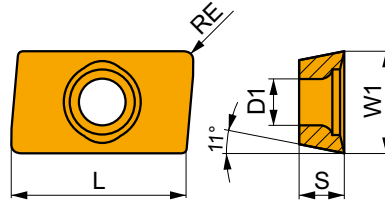



APMT 16

	W1	D1	L	S
	[mm]	[mm]	[mm]	[mm]
1604	9.600	4.50	17.00	4.76



Suitability and starting values for cutting speed (vc), feed (f) and depth of cut (ap). Refer to our Machining Calculator app for further calculations.

Product	RE	P			M			K			N			S			H				
		vc	f	ap	vc	f	ap	vc	f	ap	vc	f	ap	vc	f	ap	vc	f	ap		
	[mm]	[m/min]	[mm/tooth]	[mm]	[m/min]	[mm/tooth]	[mm]	[m/min]	[mm/tooth]	[mm]	[m/min]	[mm/tooth]	[mm]	[m/min]	[mm/tooth]	[mm]	[m/min]	[mm/tooth]	[mm]		
  <p>F geometry with positive design for light machining.</p>																					
APMT 1604PDER-F	M8330	-	290	0.15	2.0	170	0.14	2.0	275	0.15	2.0	-	-	-	70	0.11	1.6	-	-	-	
  <p>FM geometry with positive design for light to medium machining.</p>																					
APMT 1604PDER-FM	M8330	-	285	0.16	2.0	170	0.14	2.0	270	0.16	2.0	-	-	-	70	0.13	1.6	-	-	-	
	M8345	-	205	0.16	2.0	120	0.14	2.0	-	-	-	-	-	-	50	0.13	1.6	-	-	-	
  <p>ER-R geometry with positive design for rough machining.</p>																					
APMT 1604PDER-R	M8330	-	255	0.16	5.0	-	-	-	240	0.16	5.0	-	-	-	-	-	-	-	-	-	
	M8345	-	185	0.16	5.0	-	-	-	-	-	-	-	-	-	-	-	-	-	-	-	
  <p>SR-R geometry with positive design for rough machining.</p>																					
APMT 1604PDSR-R	M8330	-	255	0.18	5.0	-	-	-	240	0.18	5.0	-	-	-	-	-	-	-	-	-	
	M8345	-	180	0.18	5.0	-	-	-	-	-	-	-	-	-	-	-	-	-	-	-	



CNM

	D1	L	S
	[mm]	[mm]	[mm]
63	5.50	15.00	8.00

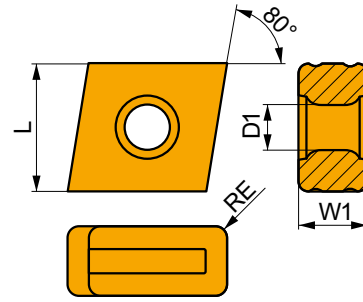

Suitability and starting values for cutting speed (vc), feed (f) and depth of cut (ap). Refer to our Machining Calculator app for further calculations.

Product	RE	P			M			K			N			S			H		
		vc	f	ap	vc	f	ap	vc	f	ap	vc	f	ap	vc	f	ap	vc	f	ap
	[mm]	[m/min]	[mm/tooth]	[mm]	[m/min]	[mm/tooth]	[mm]	[m/min]	[mm/tooth]	[mm]	[m/min]	[mm/tooth]	[mm]	[m/min]	[mm/tooth]	[mm]	[m/min]	[mm/tooth]	[mm]

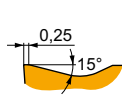

Universal geometry.

CNM 563	M8330	1.2	■	185	0.30	10.0	■	–	–	–	■	175	0.30	10.0	■	–	–	–	■	–	–	–
	M8340	1.2	■	220	0.30	10.0	■	–	–	–	■	205	0.30	10.0	■	–	–	–	■	–	–	–

ODMT 05

	IC	D1	S
	[mm]	[mm]	[mm]
0504	12.700	4.40	4.76

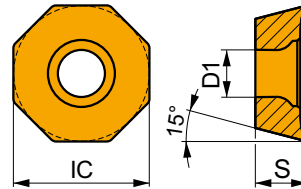

Suitability and starting values for cutting speed (vc), feed (f) and depth of cut (ap). Refer to our Machining Calculator app for further calculations.

Product	RE	P			M			K			N			S			H		
		vc	f	ap	vc	f	ap	vc	f	ap	vc	f	ap	vc	f	ap	vc	f	ap
	[mm]	[m/min]	[mm/tooth]	[mm]	[m/min]	[mm/tooth]	[mm]	[m/min]	[mm/tooth]	[mm]	[m/min]	[mm/tooth]	[mm]	[m/min]	[mm/tooth]	[mm]	[m/min]	[mm/tooth]	[mm]

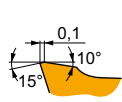

Slightly positive design for medium machining.

ODMT 0504ZZN	M8340	–	■	195	0.25	1.5	■	–	–	–	■	185	0.25	1.5	■	–	–	–	■	–	–	–
--------------	-------	---	---	-----	------	-----	---	---	---	---	---	-----	------	-----	---	---	---	---	---	---	---	---



OFKR 07

	IC	D1	S
	[mm]	[mm]	[mm]
0704	17.845	2.65	4.56

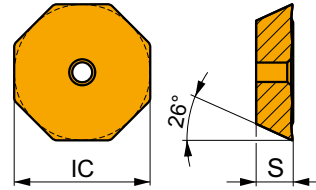

Suitability and starting values for cutting speed (vc), feed (f) and depth of cut (ap). Refer to our Machining Calculator app for further calculations.

Product	RE	P			M			K			N			S			H		
		vc	f	ap	vc	f	ap	vc	f	ap	vc	f	ap	vc	f	ap	vc	f	ap
	[mm]	[m/min]	[mm/tooth]	[mm]	[m/min]	[mm/tooth]	[mm]	[m/min]	[mm/tooth]	[mm]	[m/min]	[mm/tooth]	[mm]	[m/min]	[mm/tooth]	[mm]	[m/min]	[mm/tooth]	[mm]

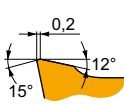
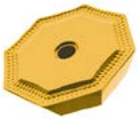

M geometry with positive design for light to medium machining.

OFKR 0704SN-M	M8330	-	■	235	0.25	1.5	■	140	0.23	1.5	■	220	0.25	1.5	-	-	-	-	-	-
	M8340	-	■	215	0.25	1.5	■	125	0.23	1.5	■	200	0.25	1.5	-	-	-	-	-	-

RDET

	INSD	D1	S
	[mm]	[mm]	[mm]
0802	8.0	3.40	2.38
1003	10.0	4.40	3.18
12T3	12.0	4.40	3.97

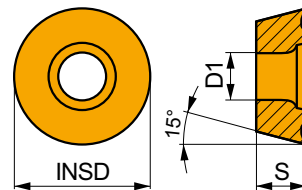

Suitability and starting values for cutting speed (vc), feed (f) and depth of cut (ap). Refer to our Machining Calculator app for further calculations.

Product	RE	P			M			K			N			S			H		
		vc	f	ap	vc	f	ap	vc	f	ap	vc	f	ap	vc	f	ap	vc	f	ap
	[mm]	[m/min]	[mm/tooth]	[mm]	[m/min]	[mm/tooth]	[mm]	[m/min]	[mm/tooth]	[mm]	[m/min]	[mm/tooth]	[mm]	[m/min]	[mm/tooth]	[mm]	[m/min]	[mm/tooth]	[mm]

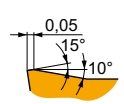

Positive design for finish machining.

RDET 0802MOSN	M8340	-	■	335	0.15	0.5	■	200	0.14	0.5	■	315	0.15	0.5	-	-	-	■	80	0.12	0.4	-	-	-
RDET 1003MOSN	M8340	-	■	310	0.15	1.0	■	185	0.14	1.0	■	290	0.15	1.0	-	-	-	■	75	0.12	0.8	-	-	-
RDET 12T3MOSN	M8340	-	■	280	0.20	1.5	■	165	0.18	1.5	■	265	0.20	1.5	-	-	-	■	70	0.14	1.2	-	-	-



RDEX

	INSD	D1	S
	[mm]	[mm]	[mm]
1204	12.0	4.40	4.76
1604	16.0	5.50	4.76

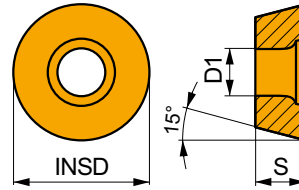

Suitability and starting values for cutting speed (vc), feed (f) and depth of cut (ap). Refer to our Machining Calculator app for further calculations.

Product	RE	P			M			K			N			S			H		
		vc	f	ap	vc	f	ap	vc	f	ap	vc	f	ap	vc	f	ap	vc	f	ap
	[mm]	[m/min]	[mm/tooth]	[mm]	[m/min]	[mm/tooth]	[mm]	[m/min]	[mm/tooth]	[mm]	[m/min]	[mm/tooth]	[mm]	[m/min]	[mm/tooth]	[mm]	[m/min]	[mm/tooth]	[mm]

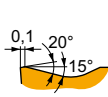

Positive design for finish machining.

RDEX 1204MOSN-12	M8340	-	205	0.30	1.5	120	0.27	1.5	190	0.30	1.5	-	-	-	50	0.21	1.2	-	-	-
RDEX 1604MOSN-12	M8340	-	195	0.30	2.0	115	0.27	2.0	185	0.30	2.0	-	-	-	45	0.24	1.6	-	-	-

RDHX 20

	INSD	D1	S
	[mm]	[mm]	[mm]
2006	20.0	5.20	6.35

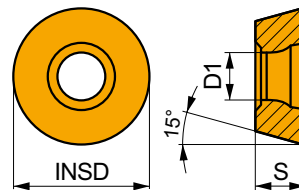

Suitability and starting values for cutting speed (vc), feed (f) and depth of cut (ap). Refer to our Machining Calculator app for further calculations.

Product	RE	P			M			K			N			S			H		
		vc	f	ap	vc	f	ap	vc	f	ap	vc	f	ap	vc	f	ap	vc	f	ap
	[mm]	[m/min]	[mm/tooth]	[mm]	[m/min]	[mm/tooth]	[mm]	[m/min]	[mm/tooth]	[mm]	[m/min]	[mm/tooth]	[mm]	[m/min]	[mm/tooth]	[mm]	[m/min]	[mm/tooth]	[mm]

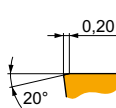

Zero rake angle design for finish machining.

RDHX 2006MOT	M8310	-	240	0.35	3.0	-	-	-	225	0.35	3.0	-	-	-	-	-	-	45	0.15	1.0
	M8325	-	180	0.35	3.0	-	-	-	-	-	-	-	-	-	-	-	-	-	-	-



RPET 12

	INSD	D1	S
	[mm]	[mm]	[mm]
1204	12.0	4.40	4.76

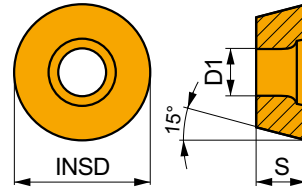

Suitability and starting values for cutting speed (vc), feed (f) and depth of cut (ap). Refer to our Machining Calculator app for further calculations.

Product	RE	P			M			K			N			S			H		
		vc	f	ap	vc	f	ap	vc	f	ap	vc	f	ap	vc	f	ap	vc	f	ap
	[mm]	[m/min]	[mm/tooth]	[mm]	[m/min]	[mm/tooth]	[mm]	[m/min]	[mm/tooth]	[mm]	[m/min]	[mm/tooth]	[mm]	[m/min]	[mm/tooth]	[mm]	[m/min]	[mm/tooth]	[mm]

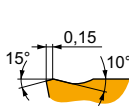

Positive design for finish machining.

RPET 1204MOSN	8215	–	■	325	0.20	1.5	▣	195	0.18	1.5	▣	305	0.20	1.5	–	–	–	▣	80	0.14	1.2	–	–	–
	M8330	–	■	320	0.20	1.5	▣	190	0.18	1.5	▣	300	0.20	1.5	–	–	–	▣	80	0.14	1.2	–	–	–
	M8340	–	■	295	0.20	1.5	▣	175	0.18	1.5	▣	280	0.20	1.5	–	–	–	▣	70	0.14	1.2	–	–	–

RPEW 12

	INSD	D1	S
	[mm]	[mm]	[mm]
1204	12.0	4.40	4.76

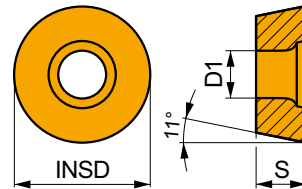

Suitability and starting values for cutting speed (vc), feed (f) and depth of cut (ap). Refer to our Machining Calculator app for further calculations.

Product	RE	P			M			K			N			S			H		
		vc	f	ap	vc	f	ap	vc	f	ap	vc	f	ap	vc	f	ap	vc	f	ap
	[mm]	[m/min]	[mm/tooth]	[mm]	[m/min]	[mm/tooth]	[mm]	[m/min]	[mm/tooth]	[mm]	[m/min]	[mm/tooth]	[mm]	[m/min]	[mm/tooth]	[mm]	[m/min]	[mm/tooth]	[mm]

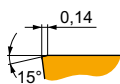

Zero rake angle design for finish machining.

RPEW 1204MOSN	M8330	–	▣	285	0.20	1.5	–	–	–	■	270	0.20	1.5	–	–	–	–	–	–	▣	55	0.15	1.0
	M8340	–	▣	265	0.20	1.5	–	–	–	▣	250	0.20	1.5	–	–	–	–	–	–	–	–	–	–



RPEX

PRAMET

	INSD	D1	S
	[mm]	[mm]	[mm]
1204	12.0	4.40	4.76

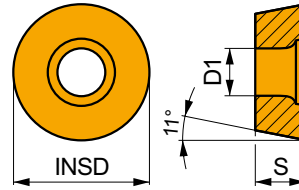

Suitability and starting values for cutting speed (vc), feed (f) and depth of cut (ap). Refer to our Machining Calculator app for further calculations.

Product	RE	P			M			K			N			S			H		
		vc	f	ap	vc	f	ap	vc	f	ap	vc	f	ap	vc	f	ap	vc	f	ap
	[mm]	[m/min]	[mm/tooth]	[mm]	[m/min]	[mm/tooth]	[mm]	[m/min]	[mm/tooth]	[mm]	[m/min]	[mm/tooth]	[mm]	[m/min]	[mm/tooth]	[mm]	[m/min]	[mm/tooth]	[mm]

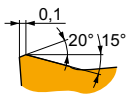

Positive design for finish machining.

RPEX 1204MOSN-12	M8330	–	235	0.30	1.5	140	0.27	1.5	220	0.30	1.5	–	–	–	55	0.21	1.2	–	–	–
	M8340	–	215	0.30	1.5	125	0.27	1.5	200	0.30	1.5	–	–	–	50	0.21	1.2	–	–	–

SEEN

PRAMET

	IC	M	S
	[mm]	[mm]	[mm]
1203	12.700	2	3.18
1504	15.875	2	4.76

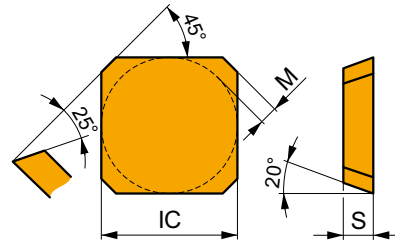

Suitability and starting values for cutting speed (vc), feed (f) and depth of cut (ap). Refer to our Machining Calculator app for further calculations.

Product	RE	P			M			K			N			S			H		
		vc	f	ap	vc	f	ap	vc	f	ap	vc	f	ap	vc	f	ap	vc	f	ap
	[mm]	[m/min]	[mm/tooth]	[mm]	[m/min]	[mm/tooth]	[mm]	[m/min]	[mm/tooth]	[mm]	[m/min]	[mm/tooth]	[mm]	[m/min]	[mm/tooth]	[mm]	[m/min]	[mm/tooth]	[mm]

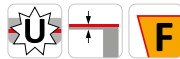
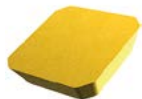

AFFN edge preparation, zero rake angle geometry for light to medium machining.

SEEN 1203AFFN	M8330	–	270	0.15	2.0	160	0.14	2.0	255	0.15	2.0	–	–	–	–	–	–	–	–	–
	M8340	–	245	0.15	2.0	145	0.14	2.0	230	0.15	2.0	–	–	–	–	–	–	–	–	–

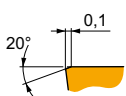
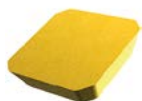

AFSN edge preparation, zero rake angle geometry for medium to heavy machining.

SEEN 1203AFSN	8215	–	255	0.20	2.0	–	–	–	240	0.20	2.0	–	–	–	–	–	–	50	0.15	1.0
	M8330	–	255	0.20	2.0	–	–	–	240	0.20	2.0	–	–	–	–	–	–	50	0.15	1.0
	M8340	–	230	0.20	2.0	–	–	–	215	0.20	2.0	–	–	–	–	–	–	–	–	–
	M9315	–	340	0.20	2.0	–	–	–	320	0.20	2.0	–	–	–	–	–	–	65	0.15	1.0
	M9325	–	315	0.20	2.0	–	–	–	295	0.20	2.0	–	–	–	–	–	–	60	0.15	1.0
	M9340	–	285	0.20	2.0	–	–	–	–	–	–	–	–	–	–	–	–	–	–	–



Suitability and starting values for cutting speed (vc), feed (f) and depth of cut (ap). Refer to our Machining Calculator app for further calculations.

Product	RE [mm]	P			M			K			N			S			H		
		vc [m/min]	f [mm/tooth]	ap [mm]	vc [m/min]	f [mm/tooth]	ap [mm]	vc [m/min]	f [mm/tooth]	ap [mm]	vc [m/min]	f [mm/tooth]	ap [mm]	vc [m/min]	f [mm/tooth]	ap [mm]	vc [m/min]	f [mm/tooth]	ap [mm]

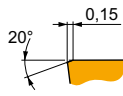
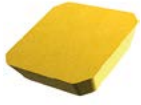

AFEN edge preparation, zero rake angle geometry for medium to heavy machining.

SEEN 1504AFSN	M8330	-	■	240	0.20	3.0	■	-	-	-	■	225	0.20	3.0	■	-	-	-	■	45	0.15	1.0
	M8340	-	■	225	0.20	3.0	■	-	-	-	■	210	0.20	3.0	■	-	-	-	■	-	-	-
	M9315	-	■	320	0.20	3.0	■	-	-	-	■	300	0.20	3.0	■	-	-	-	■	60	0.15	1.0
	M9325	-	■	300	0.20	3.0	■	-	-	-	■	285	0.20	3.0	■	-	-	-	■	60	0.15	1.0

SEER



	IC [mm]	M [mm]	S [mm]
1203	12.700	2	3.18
1204	12.700	2	4.76
1504	15.875	2	4.76

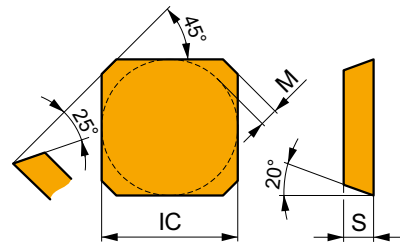

Suitability and starting values for cutting speed (vc), feed (f) and depth of cut (ap). Refer to our Machining Calculator app for further calculations.

Product	RE [mm]	P			M			K			N			S			H		
		vc [m/min]	f [mm/tooth]	ap [mm]	vc [m/min]	f [mm/tooth]	ap [mm]	vc [m/min]	f [mm/tooth]	ap [mm]	vc [m/min]	f [mm/tooth]	ap [mm]	vc [m/min]	f [mm/tooth]	ap [mm]	vc [m/min]	f [mm/tooth]	ap [mm]

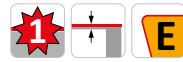
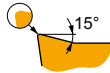

AFEN edge preparation, chipbreaker geometry for medium to heavy machining.

SEER 1203AFEN	M8330	-	■	265	0.24	2.5	■	155	0.22	2.5	■	250	0.24	2.5	■	-	-	-	■	65	0.22	2.0	■	-	-	-
	M8340	-	■	245	0.24	2.5	■	145	0.22	2.5	■	230	0.24	2.5	■	-	-	-	■	60	0.22	2.0	■	-	-	-
SEER 1504AFEN	M8330	-	■	250	0.27	3.5	■	150	0.24	3.5	■	235	0.27	3.5	■	-	-	-	■	60	0.24	2.8	■	-	-	-

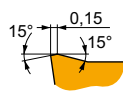

AFEN edge preparation, chipbreaker geometry for medium to heavy machining.

SEER 1203AFSN	M8330	-	■	265	0.25	2.5	■	155	0.23	2.5	■	250	0.25	2.5	■	-	-	-	■	65	0.20	2.0	■	-	-	-
	M8340	-	■	240	0.25	2.5	■	140	0.23	2.5	■	225	0.25	2.5	■	-	-	-	■	60	0.20	2.0	■	-	-	-
	M9325	-	■	315	0.25	2.5	■	-	-	-	■	295	0.25	2.5	■	-	-	-	■	-	-	-	■	-	-	-
	M9340	-	■	285	0.25	2.5	■	170	0.23	2.5	■	-	-	-	■	-	-	-	■	70	0.20	2.0	■	-	-	-
SEER 1204AFSN	M8330	-	■	265	0.25	2.5	■	155	0.23	2.5	■	250	0.25	2.5	■	-	-	-	■	65	0.20	2.0	■	-	-	-
SEER 1504AFSN	M8330	-	■	255	0.25	3.5	■	150	0.23	3.5	■	240	0.25	3.5	■	-	-	-	■	60	0.20	2.8	■	-	-	-
	M8340	-	■	230	0.25	3.5	■	135	0.23	3.5	■	215	0.25	3.5	■	-	-	-	■	55	0.20	2.8	■	-	-	-
	M9325	-	■	305	0.25	3.5	■	-	-	-	■	285	0.25	3.5	■	-	-	-	■	-	-	-	■	-	-	-



SEET 12

PRAMET

	IC	D1	M	S
	[mm]	[mm]	[mm]	[mm]
1204	12.700	5.50	2	4.76

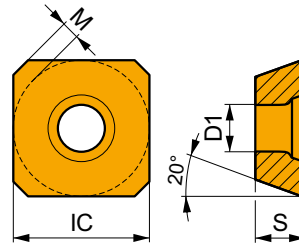

Suitability and starting values for cutting speed (vc), feed (f) and depth of cut (ap). Refer to our Machining Calculator app for further calculations.

Product	RE	P			M			K			N			S			H		
		vc	f	ap	vc	f	ap	vc	f	ap	vc	f	ap	vc	f	ap	vc	f	ap
	[mm]	[m/min]	[mm/tooth]	[mm]	[m/min]	[mm/tooth]	[mm]	[m/min]	[mm/tooth]	[mm]	[m/min]	[mm/tooth]	[mm]	[m/min]	[mm/tooth]	[mm]	[m/min]	[mm/tooth]	[mm]

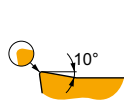
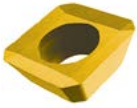

AFEN edge preparation, positive all purpose geometry.

SEET 1204AFEN	M8330	-	265	0.24	2.5	155	0.22	2.5	250	0.24	2.5	-	-	-	65	0.22	2.0	-	-	-
---------------	-------	---	-----	------	-----	-----	------	-----	-----	------	-----	---	---	---	----	------	-----	---	---	---

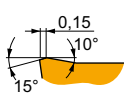
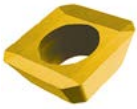

AFSN edge preparation, positive all purpose geometry.

SEET 1204AFSN	8215	-	265	0.23	2.5	155	0.21	2.5	250	0.23	2.5	-	-	-	65	0.21	2.0	-	-	-
	M8330	-	265	0.24	2.5	155	0.22	2.5	250	0.24	2.5	-	-	-	65	0.22	2.0	-	-	-
	M8340	-	240	0.25	2.5	140	0.23	2.5	225	0.25	2.5	-	-	-	60	0.23	2.0	-	-	-
	M9325	-	340	0.20	2.5	-	-	-	320	0.20	2.5	-	-	-	-	-	-	-	-	-
	M9340	-	290	0.23	2.5	170	0.21	2.5	-	-	-	-	-	-	70	0.21	2.0	-	-	-

SEET 12-FA

PRAMET

	IC	D1	M	S
	[mm]	[mm]	[mm]	[mm]
1204	12.700	5.50	2	4.76

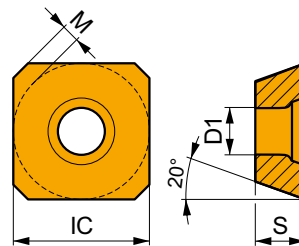

Suitability and starting values for cutting speed (vc), feed (f) and depth of cut (ap). Refer to our Machining Calculator app for further calculations.

Product	RE	P			M			K			N			S			H		
		vc	f	ap	vc	f	ap	vc	f	ap	vc	f	ap	vc	f	ap	vc	f	ap
	[mm]	[m/min]	[mm/tooth]	[mm]	[m/min]	[mm/tooth]	[mm]	[m/min]	[mm/tooth]	[mm]	[m/min]	[mm/tooth]	[mm]	[m/min]	[mm/tooth]	[mm]	[m/min]	[mm/tooth]	[mm]

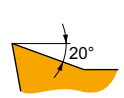
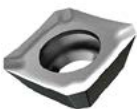

FA geometry with highly positive design for fine-finish to medium machining.

SEET 1204AFFN-FA	HF7	-	-	-	-	-	-	-	330	0.18	3.0	-	-	-	-	-	-	-	-	-
	M0315	-	-	-	-	-	-	-	780	0.18	3.0	-	-	-	-	-	-	-	-	-



SEET 12-PM

	IC	D1	M	S
	[mm]	[mm]	[mm]	[mm]
12T3	13.400	4.20	2	3.97

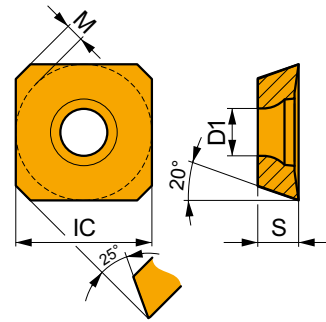

Suitability and starting values for cutting speed (vc), feed (f) and depth of cut (ap). Refer to our Machining Calculator app for further calculations.

Product	RE	P			M			K			N			S			H		
		vc	f	ap	vc	f	ap	vc	f	ap	vc	f	ap	vc	f	ap	vc	f	ap
	[mm]	[m/min]	[mm/tooth]	[mm]	[m/min]	[mm/tooth]	[mm]	[m/min]	[mm/tooth]	[mm]	[m/min]	[mm/tooth]	[mm]	[m/min]	[mm/tooth]	[mm]	[m/min]	[mm/tooth]	[mm]

PM geometry with positive all purpose design.

SEET 12T3M-PM	M8330	-	265	0.25	2.0	155	0.23	2.0	250	0.25	2.0	-	-	-	65	0.20	1.6	-	-	-	
	M8340	-	245	0.25	2.0	145	0.23	2.0	230	0.25	2.0	-	-	-	60	0.20	1.6	-	-	-	
	M9325	-	325	0.25	2.0	-	-	-	305	0.25	2.0	-	-	-	-	-	-	-	-	-	-
	M9340	-	290	0.25	2.0	170	0.23	2.0	-	-	-	-	-	-	70	0.20	1.6	-	-	-	

SEEW 12

	IC	D1	M	S
	[mm]	[mm]	[mm]	[mm]
1204	12.700	5.50	2	4.76

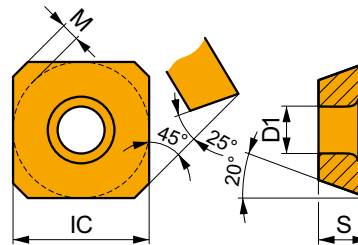

Suitability and starting values for cutting speed (vc), feed (f) and depth of cut (ap). Refer to our Machining Calculator app for further calculations.

Product	RE	P			M			K			N			S			H		
		vc	f	ap	vc	f	ap	vc	f	ap	vc	f	ap	vc	f	ap	vc	f	ap
	[mm]	[m/min]	[mm/tooth]	[mm]	[m/min]	[mm/tooth]	[mm]	[m/min]	[mm/tooth]	[mm]	[m/min]	[mm/tooth]	[mm]	[m/min]	[mm/tooth]	[mm]	[m/min]	[mm/tooth]	[mm]

AFEN edge preparation with zero rake angle geometry for light to medium machining.

SEEW 1204AFEN	M8330	-	265	0.15	2.5	-	-	-	250	0.15	2.5	-	-	-	-	-	-	-	-	-
	M8340	-	240	0.15	2.5	-	-	-	225	0.15	2.5	-	-	-	-	-	-	-	-	-

AFSN edge preparation with zero rake angle geometry for light to medium machining.

SEEW 1204AFSN	8215	-	250	0.20	2.5	-	-	-	235	0.20	2.5	-	-	-	-	-	-	50	0.15	1.0
	M8330	-	245	0.20	2.5	-	-	-	230	0.20	2.5	-	-	-	-	-	-	45	0.15	1.0
	M8340	-	225	0.20	2.5	-	-	-	210	0.20	2.5	-	-	-	-	-	-	-	-	-
	M9325	-	305	0.20	2.5	-	-	-	285	0.20	2.5	-	-	-	-	-	-	60	0.15	1.0



SFCN

PRAMET

	IC [mm]	M [mm]	S [mm]	BS [mm]
1203	12.700	1	3.18	2.00

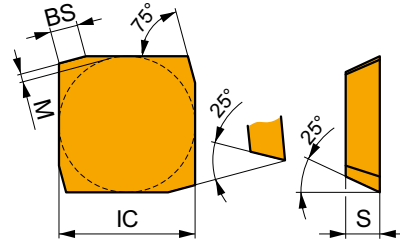

Suitability and starting values for cutting speed (vc), feed (f) and depth of cut (ap). Refer to our Machining Calculator app for further calculations.

Product	RE [mm]	P			M			K			N			S			H		
		vc [m/min]	f [mm/tooth]	ap [mm]	vc [m/min]	f [mm/tooth]	ap [mm]	vc [m/min]	f [mm/tooth]	ap [mm]	vc [m/min]	f [mm/tooth]	ap [mm]	vc [m/min]	f [mm/tooth]	ap [mm]	vc [m/min]	f [mm/tooth]	ap [mm]

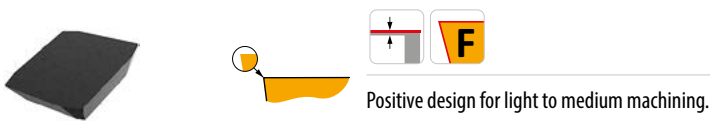

SFCN 1203EFFR	H10	-	-	-	-	-	-	-	-	405	0.12	3.0	-	-	-	-	-	-
	M0315	-	-	-	-	-	-	-	-	765	0.12	3.0	-	-	-	-	-	-

SNHF

PRAMET

	BS [mm]	IC [mm]	M [mm]	S [mm]
1204	2.00	12.700	1	4.76
1504	1.40	15.875	1	4.76

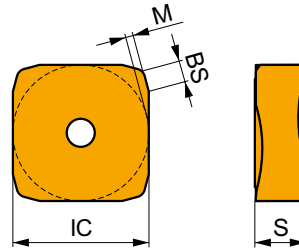

Suitability and starting values for cutting speed (vc), feed (f) and depth of cut (ap). Refer to our Machining Calculator app for further calculations.

Product	RE [mm]	P			M			K			N			S			H		
		vc [m/min]	f [mm/tooth]	ap [mm]	vc [m/min]	f [mm/tooth]	ap [mm]	vc [m/min]	f [mm/tooth]	ap [mm]	vc [m/min]	f [mm/tooth]	ap [mm]	vc [m/min]	f [mm/tooth]	ap [mm]	vc [m/min]	f [mm/tooth]	ap [mm]

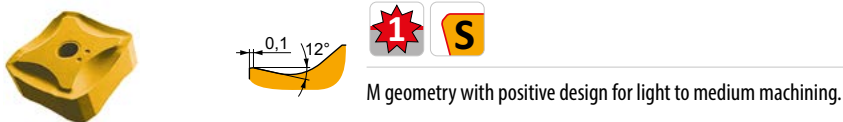

SNHF 1204ENSR-M	M8330	-	235	0.15	4.0	-	-	-	220	0.15	4.0	-	-	-	-	-	-	-
	M8340	-	230	0.15	4.0	-	-	-	215	0.15	4.0	-	-	-	-	-	-	-
SNHF 1504ENSR-M	M8330	-	225	0.15	6.0	-	-	-	210	0.15	6.0	-	-	-	-	-	-	-
	M8340	-	220	0.15	6.0	-	-	-	205	0.15	6.0	-	-	-	-	-	-	-



SNHN



	BS [mm]	IC [mm]	M [mm]	S [mm]
1204	1.40	12.700	1	4.76
1504	1.40	15.875	1	4.76

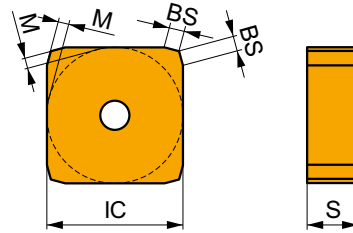

Suitability and starting values for cutting speed (vc), feed (f) and depth of cut (ap). Refer to our Machining Calculator app for further calculations.

Product	RE [mm]	P			M			K			N			S			H		
		vc [m/min]	f [mm/tooth]	ap [mm]	vc [m/min]	f [mm/tooth]	ap [mm]	vc [m/min]	f [mm/tooth]	ap [mm]	vc [m/min]	f [mm/tooth]	ap [mm]	vc [m/min]	f [mm/tooth]	ap [mm]	vc [m/min]	f [mm/tooth]	ap [mm]

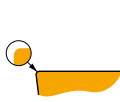
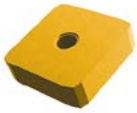

Standard negative milling geometry for 75° face milling.

SNHN 1204ENEN	8215	-	✓	275	0.15	6.0	-	-	-	■	260	0.15	6.0	-	-	-	-	-	-	✓	55	0.15	1.0
	M8330	-	✓	270	0.15	6.0	-	-	-	■	255	0.15	6.0	-	-	-	-	-	-	✓	50	0.15	1.0
	M8340	-	✓	245	0.15	6.0	-	-	-	■	230	0.15	6.0	-	-	-	-	-	-	-	-	-	-
	M9325	-	✓	340	0.15	6.0	-	-	-	■	320	0.15	6.0	-	-	-	-	-	-	✓	65	0.15	1.0
	S26	-	✓	110	0.15	6.0	-	-	-	-	-	-	-	-	-	-	-	-	-	-	-	-	-
SNHN 1504ENEN	8215	-	✓	260	0.15	9.0	-	-	-	■	245	0.15	9.0	-	-	-	-	-	-	✓	50	0.15	1.0
	M8330	-	✓	260	0.15	9.0	-	-	-	■	245	0.15	9.0	-	-	-	-	-	-	✓	50	0.15	1.0
	M8340	-	✓	235	0.15	9.0	-	-	-	■	220	0.15	9.0	-	-	-	-	-	-	-	-	-	-
	S26	-	✓	105	0.15	9.0	-	-	-	-	-	-	-	-	-	-	-	-	-	-	-	-	-

SNKX



	IC [mm]	M [mm]	S [mm]
1204	12.700	1	4.76
1504	15.875	1	4.76

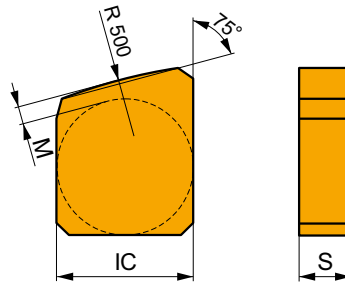

Suitability and starting values for cutting speed (vc), feed (f) and depth of cut (ap). Refer to our Machining Calculator app for further calculations.

Product	RE [mm]	P			M			K			N			S			H		
		vc [m/min]	f [mm/tooth]	ap [mm]	vc [m/min]	f [mm/tooth]	ap [mm]	vc [m/min]	f [mm/tooth]	ap [mm]	vc [m/min]	f [mm/tooth]	ap [mm]	vc [m/min]	f [mm/tooth]	ap [mm]	vc [m/min]	f [mm/tooth]	ap [mm]



Standard negative wiper geometry for 75° face milling.

SNKX 1204ENFN	H10	-	-	-	-	-	-	■	115	0.15	6.0	-	-	-	-	-	-	-	-	-	-	-	-
SNKX 1504ENFN	H10	-	-	-	-	-	-	■	110	0.15	9.0	-	-	-	-	-	-	-	-	-	-	-	-



SNUN



	IC [mm]	S [mm]
1204	12.700	4.76
1504	15.875	4.76

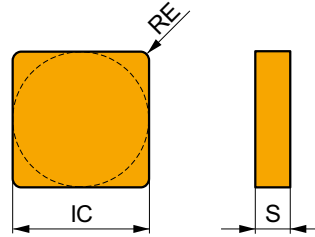

Suitability and starting values for cutting speed (vc), feed (f) and depth of cut (ap). Refer to our Machining Calculator app for further calculations.

Product	RE [mm]	P			M			K			N			S			H		
		vc [m/min]	f [mm/tooth]	ap [mm]	vc [m/min]	f [mm/tooth]	ap [mm]	vc [m/min]	f [mm/tooth]	ap [mm]	vc [m/min]	f [mm/tooth]	ap [mm]	vc [m/min]	f [mm/tooth]	ap [mm]			

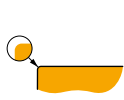
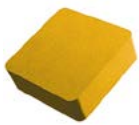

Negative geometry milling insert, can also be used for turning.

SNUN 120408	M8330	0.8	✓ 260	0.13	4.5	–	–	–	✗ 245	0.13	4.5	–	–	–	–	–	–	–	✗ 50	0.15	1.0
SNUN 120412	M8330	1.2	✓ 275	0.13	4.5	–	–	–	✗ 260	0.13	4.5	–	–	–	–	–	–	–	✗ 55	0.15	1.0
	S26	1.2	✓ 110	0.13	4.5	–	–	–	–	–	–	–	–	–	–	–	–	–	–	–	–
SNUN 150412	M8330	1.2	✓ 255	0.15	6.0	–	–	–	✗ 240	0.15	6.0	–	–	–	–	–	–	–	✗ 50	0.15	1.0

SPGN



	IC [mm]	S [mm]
0903	9.525	3.18
1203	12.700	3.18
1504	15.875	4.76

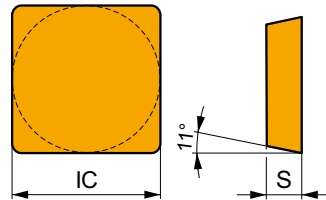

Suitability and starting values for cutting speed (vc), feed (f) and depth of cut (ap). Refer to our Machining Calculator app for further calculations.

Product	RE [mm]	P			M			K			N			S			H		
		vc [m/min]	f [mm/tooth]	ap [mm]	vc [m/min]	f [mm/tooth]	ap [mm]	vc [m/min]	f [mm/tooth]	ap [mm]	vc [m/min]	f [mm/tooth]	ap [mm]	vc [m/min]	f [mm/tooth]	ap [mm]			

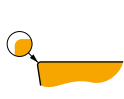

Zero rake angle design milling insert, can also be used for turning.

SPGN 090308	M8340	0.8	✗ 225	0.15	2.0	–	–	–	✓ 210	0.15	2.0	–	–	–	–	–	–	–	–	–	–
SPGN 120304	M8330	0.4	✗ 195	0.15	4.0	–	–	–	✗ 185	0.15	4.0	–	–	–	–	–	–	–	–	–	–
	M8340	0.4	✗ 175	0.15	4.0	–	–	–	✓ 165	0.15	4.0	–	–	–	–	–	–	–	–	–	–
SPGN 120308	M8330	0.8	✗ 230	0.15	4.0	–	–	–	✗ 215	0.15	4.0	–	–	–	–	–	–	–	–	–	–
SPGN 150412	M8330	1.2	✗ 225	0.20	5.0	–	–	–	✓ 210	0.20	5.0	–	–	–	–	–	–	–	–	–	–



SPGN 25 DZ



	IC	M	S	BS
	[mm]	[mm]	[mm]	[mm]
2506	25.000	3	6.35	2.40

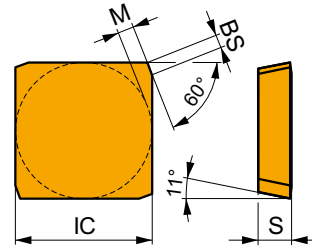

Suitability and starting values for cutting speed (vc), feed (f) and depth of cut (ap). Refer to our Machining Calculator app for further calculations.

Product	RE	P			M			K			N			S			H		
		vc	f	ap	vc	f	ap	vc	f	ap	vc	f	ap	vc	f	ap	vc	f	ap
	[mm]	[m/min]	[mm/tooth]	[mm]	[m/min]	[mm/tooth]	[mm]	[m/min]	[mm/tooth]	[mm]	[m/min]	[mm/tooth]	[mm]	[m/min]	[mm/tooth]	[mm]	[m/min]	[mm/tooth]	[mm]

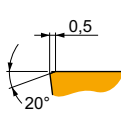

DZ geometry with zero rake angle design for heavy machining.

SPGN 2506DZSR	M8326	-	110	0.50	12.0	-	-	-	100	0.50	12.0	-	-	-	-	-	-	-	-
	M8346	-	90	0.50	12.0	-	-	-	-	-	-	-	-	-	-	-	-	-	-

SPKN



	IC	M	S	BS
	[mm]	[mm]	[mm]	[mm]
1203	12.700	1	3.18	1.60
1504	15.875	1	4.76	1.70

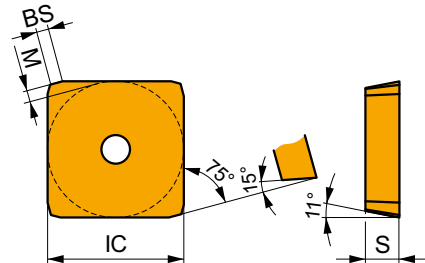

Suitability and starting values for cutting speed (vc), feed (f) and depth of cut (ap). Refer to our Machining Calculator app for further calculations.

Product	RE	P			M			K			N			S			H		
		vc	f	ap	vc	f	ap	vc	f	ap	vc	f	ap	vc	f	ap	vc	f	ap
	[mm]	[m/min]	[mm/tooth]	[mm]	[m/min]	[mm/tooth]	[mm]	[m/min]	[mm/tooth]	[mm]	[m/min]	[mm/tooth]	[mm]	[m/min]	[mm/tooth]	[mm]	[m/min]	[mm/tooth]	[mm]



EDER edge preparation with zero rake angle geometry for light to medium machining.

SPKN 1203EDER	H10	-	-	-	-	-	-	110	0.15	4.0	-	-	-	-	-	-	-	-
	M8330	-	255	0.15	4.0	-	-	-	240	0.15	4.0	-	-	-	-	-	-	-
	M8340	-	230	0.15	4.0	-	-	-	215	0.15	4.0	-	-	-	-	-	-	-
SPKN 1504EDER	H10	-	-	-	-	-	-	100	0.20	5.0	-	-	-	-	-	-	-	-
	M8330	-	235	0.20	5.0	-	-	-	220	0.20	5.0	-	-	-	-	-	-	-
	M8340	-	210	0.20	5.0	-	-	-	195	0.20	5.0	-	-	-	-	-	-	-

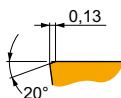

EDSR edge preparation with zero rake angle geometry for medium machining.

SPKN 1203EDSL	M8330	-	240	0.20	4.0	-	-	-	225	0.20	4.0	-	-	-	-	-	-	45	0.15	1.0
---------------	-------	---	-----	------	-----	---	---	---	-----	------	-----	---	---	---	---	---	---	----	------	-----



Suitability and starting values for cutting speed (vc), feed (f) and depth of cut (ap). Refer to our Machining Calculator app for further calculations.

Product	RE (mm)	P			M			K			N			S			H		
		vc [m/min]	f [mm/tooth]	ap [mm]	vc [m/min]	f [mm/tooth]	ap [mm]	vc [m/min]	f [mm/tooth]	ap [mm]	vc [m/min]	f [mm/tooth]	ap [mm]	vc [m/min]	f [mm/tooth]	ap [mm]	vc [m/min]	f [mm/tooth]	ap [mm]

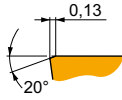

EDSR edge preparation with zero rake angle geometry for medium machining.

SPKN 1203EDSR	8215	–	240	0.20	4.0	–	–	–	225	0.20	4.0	–	–	–	–	–	–	45	0.15	1.0
	H10	–	–	–	–	–	–	–	100	0.20	4.0	–	–	–	–	–	–	–	–	–
	M8330	–	240	0.20	4.0	–	–	–	225	0.20	4.0	–	–	–	–	–	–	45	0.15	1.0
	M8340	–	215	0.20	4.0	–	–	–	200	0.20	4.0	–	–	–	–	–	–	–	–	–
	M9325	–	290	0.20	4.0	–	–	–	275	0.20	4.0	–	–	–	–	–	–	55	0.15	1.0
	S26	–	95	0.20	4.0	–	–	–	–	–	–	–	–	–	–	–	–	–	–	–

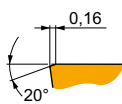
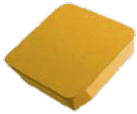

EDSR (right-hand cut) / EDSL (left-hand cut) edge preparation with zero rake angle geometry for medium machining.

SPKN 1504EDSL	M8340	–	205	0.25	5.0	–	–	–	190	0.25	5.0	–	–	–	–	–	–	–	–	–
SPKN 1504EDSR	8215	–	220	0.25	5.0	–	–	–	205	0.25	5.0	–	–	–	–	–	–	40	0.15	1.0
	H10	–	–	–	–	–	–	–	95	0.25	5.0	–	–	–	–	–	–	–	–	–
	M8330	–	220	0.25	5.0	–	–	–	205	0.25	5.0	–	–	–	–	–	–	40	0.15	1.0
	M8340	–	205	0.25	5.0	–	–	–	190	0.25	5.0	–	–	–	–	–	–	–	–	–
	M9315	–	285	0.25	5.0	–	–	–	270	0.25	5.0	–	–	–	–	–	–	55	0.15	1.0
	M9325	–	270	0.25	5.0	–	–	–	255	0.25	5.0	–	–	–	–	–	–	50	0.15	1.0
S26	–	90	0.25	5.0	–	–	–	–	–	–	–	–	–	–	–	–	–	–	–	

SPKR



	IC (mm)	L (mm)	M (mm)	S (mm)
1203	12.700	12.70	1	3.18
1504	15.875	15.88	1	4.76

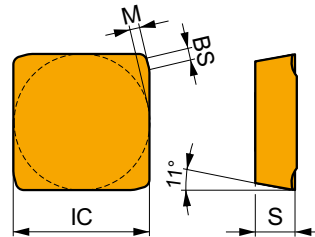

Suitability and starting values for cutting speed (vc), feed (f) and depth of cut (ap). Refer to our Machining Calculator app for further calculations.

Product	RE (mm)	P			M			K			N			S			H		
		vc [m/min]	f [mm/tooth]	ap [mm]	vc [m/min]	f [mm/tooth]	ap [mm]	vc [m/min]	f [mm/tooth]	ap [mm]	vc [m/min]	f [mm/tooth]	ap [mm]	vc [m/min]	f [mm/tooth]	ap [mm]	vc [m/min]	f [mm/tooth]	ap [mm]

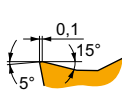

EDSR edge preparation, chipbreaker geometry for medium to heavy machining.

SPKR 1203EDSR	M8330	–	265	0.20	4.0	155	0.18	4.0	250	0.20	4.0	–	–	–	–	–	–	–	–	–
	M8340	–	240	0.20	4.0	140	0.18	4.0	225	0.20	4.0	–	–	–	–	–	–	–	–	–
	M9340	–	295	0.20	4.0	175	0.18	4.0	–	–	–	–	–	–	–	–	–	–	–	–

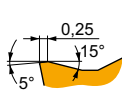

EDSR edge preparation, chipbreaker geometry for medium to heavy machining.

SPKR 1504EDSR	M8330	–	245	0.25	5.0	145	0.25	5.0	230	0.25	5.0	–	–	–	–	–	–	–	–	–
	M8340	–	225	0.25	5.0	135	0.25	5.0	210	0.25	5.0	–	–	–	–	–	–	–	–	–



SPKX

	IC [mm]	M [mm]	S [mm]
1203	12.700	1	3.18
1504	15.875	1	4.76

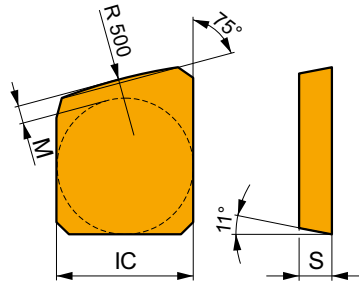

Suitability and starting values for cutting speed (vc), feed (f) and depth of cut (ap). Refer to our Machining Calculator app for further calculations.

Product	RE [mm]	P			M			K			N			S			H		
		vc [m/min]	f [mm/tooth]	ap [mm]	vc [m/min]	f [mm/tooth]	ap [mm]	vc [m/min]	f [mm/tooth]	ap [mm]	vc [m/min]	f [mm/tooth]	ap [mm]	vc [m/min]	f [mm/tooth]	ap [mm]	vc [m/min]	f [mm/tooth]	ap [mm]

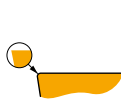
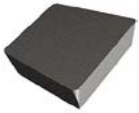

Zero rake wiper geometry for improved surface finish

SPKX 1203EDFR	H10	-	-	-	-	-	-	100	0.20	4.0	-	-	-	-	-	-	-	-
SPKX 1504EDFR	H10	-	-	-	-	-	-	95	0.25	5.0	-	-	-	-	-	-	-	-

SPUN

	IC [mm]	S [mm]
1203	12.700	3.18
1504	15.875	4.76
1904	19.050	4.76
2506	25.400	6.35

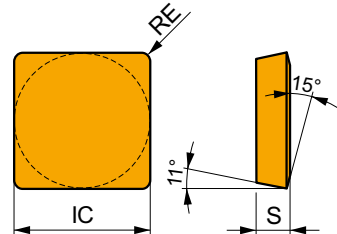

Suitability and starting values for cutting speed (vc), feed (f) and depth of cut (ap). Refer to our Machining Calculator app for further calculations.

Product	RE [mm]	P			M			K			N			S			H		
		vc [m/min]	f [mm/tooth]	ap [mm]	vc [m/min]	f [mm/tooth]	ap [mm]	vc [m/min]	f [mm/tooth]	ap [mm]	vc [m/min]	f [mm/tooth]	ap [mm]	vc [m/min]	f [mm/tooth]	ap [mm]	vc [m/min]	f [mm/tooth]	ap [mm]



Zero rake geometry milling insert, can also be used for turning.

SPUN 120304	M8330	0.4	195	0.15	4.0	-	-	-	185	0.15	4.0	-	-	-	-	-	-	-
SPUN 120308	H10	0.8	-	-	-	-	-	-	95	0.15	4.0	-	-	-	-	-	-	-
	M8330	0.8	230	0.15	4.0	-	-	-	215	0.15	4.0	-	-	-	-	-	-	-
	S26	0.8	95	0.15	4.0	-	-	-	-	-	-	-	-	-	-	-	-	-
SPUN 120312	M8330	1.2	245	0.15	4.0	-	-	-	230	0.15	4.0	-	-	-	-	-	-	-



Zero rake geometry milling insert, can also be used for turning.

SPUN 150412	M8330	1.2	225	0.20	5.0	-	-	-	210	0.20	5.0	-	-	-	-	-	-	-
SPUN 190408	M8330	0.8	210	0.20	6.0	-	-	-	195	0.20	6.0	-	-	-	-	-	-	-
SPUN 190412	M8330	1.2	220	0.20	6.0	-	-	-	205	0.20	6.0	-	-	-	-	-	-	-



Suitability and starting values for cutting speed (vc), feed (f) and depth of cut (ap). Refer to our Machining Calculator app for further calculations.

Product	RE [mm]	P			M			K			N			S			H		
		vc [m/min]	f [mm/tooth]	ap [mm]	vc [m/min]	f [mm/tooth]	ap [mm]	vc [m/min]	f [mm/tooth]	ap [mm]	vc [m/min]	f [mm/tooth]	ap [mm]	vc [m/min]	f [mm/tooth]	ap [mm]	vc [m/min]	f [mm/tooth]	ap [mm]

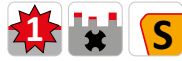
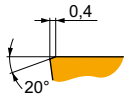

Zero rake geometry milling insert, can also be used for turning.

SPUN 250616S	M8326	1.6	115	0.40	12.0	–	–	–	105	0.40	12.0	–	–	–	–	–	–	–
SPUN 250620S	M5326	2.0	145	0.40	12.0	–	–	–	135	0.40	12.0	–	–	–	–	–	–	–
	M8326	2.0	120	0.40	12.0	–	–	–	110	0.40	12.0	–	–	–	–	–	–	–
	M8346	2.0	100	0.40	12.0	–	–	–	–	–	–	–	–	–	–	–	–	–
	S26	2.0	45	0.40	12.0	–	–	–	–	–	–	–	–	–	–	–	–	–

TNJF



	IC [mm]	L [mm]	M [mm]	S [mm]
1204	12.700	22.00	2	4.76

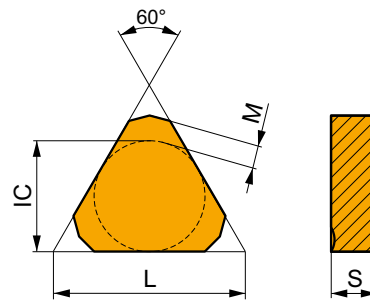

Suitability and starting values for cutting speed (vc), feed (f) and depth of cut (ap). Refer to our Machining Calculator app for further calculations.

Product	RE [mm]	P			M			K			N			S			H		
		vc [m/min]	f [mm/tooth]	ap [mm]	vc [m/min]	f [mm/tooth]	ap [mm]	vc [m/min]	f [mm/tooth]	ap [mm]	vc [m/min]	f [mm/tooth]	ap [mm]	vc [m/min]	f [mm/tooth]	ap [mm]	vc [m/min]	f [mm/tooth]	ap [mm]

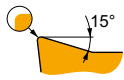

Positive rake angle with chip breaking geometry.

TNJF 1204ANEN	M8330	–	270	0.15	4.0	160	0.14	4.0	255	0.15	4.0	–	–	–	–	–	–	–
---------------	-------	---	-----	------	-----	-----	------	-----	-----	------	-----	---	---	---	---	---	---	---



TPCN 16

	BS	IC	L	M	S
	[mm]	[mm]	[mm]	[mm]	[mm]
1603	1.20	9.530	16.10	2	3.18

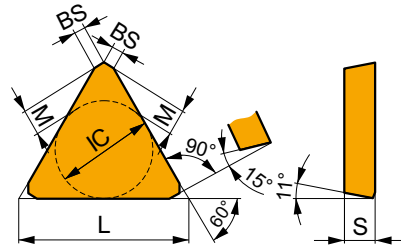

Suitability and starting values for cutting speed (vc), feed (f) and depth of cut (ap). Refer to our Machining Calculator app for further calculations.

Product	RE	P			M			K			N			S			H		
		vc	f	ap	vc	f	ap	vc	f	ap	vc	f	ap	vc	f	ap	vc	f	ap
	[mm]	[m/min]	[mm/tooth]	[mm]	[m/min]	[mm/tooth]	[mm]	[m/min]	[mm/tooth]	[mm]	[m/min]	[mm/tooth]	[mm]	[m/min]	[mm/tooth]	[mm]	[m/min]	[mm/tooth]	[mm]

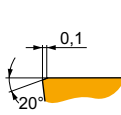

Special design for disc milling.

TPCN 1603PDSN	M8330	-	■	195	0.20	-	-	-	■	185	0.20	-	-	-	-	-	-	-	-	-
	M8340	-	■	175	0.20	-	-	-	■	165	0.20	-	-	-	-	-	-	-	-	-

TPKN

	IC	L	M	S	BCH	BS
	[mm]	[mm]	[mm]	[mm]	[mm]	[mm]
1603	9.530	16.50	2	3.18	1.20	1.30
2204	12.700	22.00	4	4.76	1.20	1.50

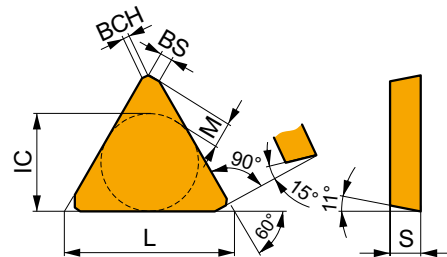

Suitability and starting values for cutting speed (vc), feed (f) and depth of cut (ap). Refer to our Machining Calculator app for further calculations.

Product	RE	P			M			K			N			S			H		
		vc	f	ap	vc	f	ap	vc	f	ap	vc	f	ap	vc	f	ap	vc	f	ap
	[mm]	[m/min]	[mm/tooth]	[mm]	[m/min]	[mm/tooth]	[mm]	[m/min]	[mm/tooth]	[mm]	[m/min]	[mm/tooth]	[mm]	[m/min]	[mm/tooth]	[mm]	[m/min]	[mm/tooth]	[mm]

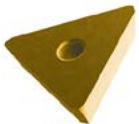

PDER edge preparation, zero rake angle geometry for light to medium machining.

TPKN 1603PDER	M8330	-	■	195	0.15	4.0	-	-	-	■	185	0.15	4.0	-	-	-	-	-	-	-
	M8340	-	■	175	0.15	4.0	-	-	-	■	165	0.15	4.0	-	-	-	-	-	-	-
TPKN 2204PDER	8215	-	■	190	0.15	5.5	-	-	-	■	180	0.15	5.5	-	-	-	-	-	-	-
	M8330	-	■	190	0.15	5.5	-	-	-	■	180	0.15	5.5	-	-	-	-	-	-	-
	M8340	-	■	170	0.15	5.5	-	-	-	■	160	0.15	5.5	-	-	-	-	-	-	-

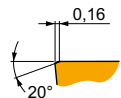
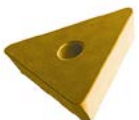

PDSR edge preparation, zero rake angle geometry for medium machining.

TPKN 1603PDSR	M8330	-	■	185	0.20	4.0	-	-	-	■	175	0.20	4.0	-	-	-	-	-	-	■	35	0.15	1.0
	M8340	-	■	165	0.20	4.0	-	-	-	■	155	0.20	4.0	-	-	-	-	-	-	-	-	-	-
	S26	-	■	75	0.20	4.0	-	-	-	-	-	-	-	-	-	-	-	-	-	-	-	-	-



Suitability and starting values for cutting speed (vc), feed (f) and depth of cut (ap). Refer to our Machining Calculator app for further calculations.

Product	RE [mm]	P			M			K			N			S			H		
		vc [m/min]	f [mm/tooth]	ap [mm]	vc [m/min]	f [mm/tooth]	ap [mm]	vc [m/min]	f [mm/tooth]	ap [mm]	vc [m/min]	f [mm/tooth]	ap [mm]	vc [m/min]	f [mm/tooth]	ap [mm]	vc [m/min]	f [mm/tooth]	ap [mm]

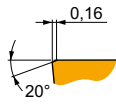
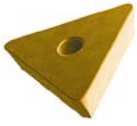

PDSR edge preparation, zero rake angle geometry for medium machining.

TPKN 2204PDSR	H10	-	-	-	-	-	-	80	0.20	5.5	-	-	-	-	-	-	-	-
	M5315	-	235	0.20	5.5	-	-	220	0.20	5.5	-	-	-	-	-	45	0.15	1.0
	M8310	-	195	0.20	5.5	-	-	185	0.20	5.5	-	-	-	-	-	35	0.15	1.0
	M8330	-	175	0.20	5.5	-	-	165	0.20	5.5	-	-	-	-	-	35	0.15	1.0
	M8340	-	160	0.20	5.5	-	-	150	0.20	5.5	-	-	-	-	-	-	-	-
	M9325	-	220	0.20	5.5	-	-	205	0.20	5.5	-	-	-	-	-	40	0.15	1.0
	S26	-	75	0.20	5.5	-	-	-	-	-	-	-	-	-	-	-	-	-

TPKR



	IC [mm]	L [mm]	M [mm]	S [mm]	BS [mm]
1603	9.530	16.50	2	3.18	1.40
2204	12.700	22.00	4	4.76	1.40

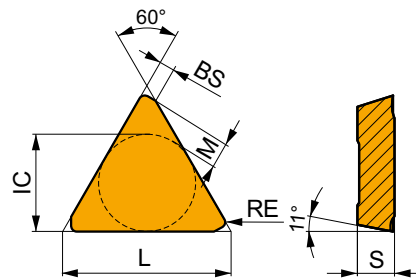

Suitability and starting values for cutting speed (vc), feed (f) and depth of cut (ap). Refer to our Machining Calculator app for further calculations.

Product	RE [mm]	P			M			K			N			S			H		
		vc [m/min]	f [mm/tooth]	ap [mm]	vc [m/min]	f [mm/tooth]	ap [mm]	vc [m/min]	f [mm/tooth]	ap [mm]	vc [m/min]	f [mm/tooth]	ap [mm]	vc [m/min]	f [mm/tooth]	ap [mm]	vc [m/min]	f [mm/tooth]	ap [mm]

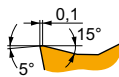

PDSR edge preparation, chipbreaker geometry for medium to heavy machining.

TPKR 1603PDSR	M8330	-	185	0.20	4.0	110	0.18	4.0	175	0.20	4.0	-	-	-	-	-	-
	M8340	-	165	0.20	4.0	95	0.18	4.0	155	0.20	4.0	-	-	-	-	-	-
TPKR 2204PDSR	M8330	-	175	0.20	5.5	105	0.18	5.5	165	0.20	5.5	-	-	-	-	-	-
	M8340	-	160	0.20	5.5	95	0.18	5.5	150	0.20	5.5	-	-	-	-	-	-
	M9325	-	220	0.20	5.5	-	-	-	205	0.20	5.5	-	-	-	-	-	-
	M9340	-	195	0.20	5.5	115	0.18	5.5	-	-	-	-	-	-	-	-	-



TPUN



	IC [mm]	L [mm]	S [mm]
1103	6.350	11.00	3.18
1603	9.525	16.50	3.18
2204	12.700	22.00	4.76

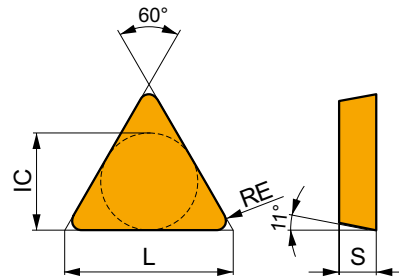

Suitability and starting values for cutting speed (vc), feed (f) and depth of cut (ap). Refer to our Machining Calculator app for further calculations.

Product	RE [mm]	P			M			K			N			S			H		
		vc [m/min]	f [mm/tooth]	ap [mm]	vc [m/min]	f [mm/tooth]	ap [mm]	vc [m/min]	f [mm/tooth]	ap [mm]	vc [m/min]	f [mm/tooth]	ap [mm]	vc [m/min]	f [mm/tooth]	ap [mm]	vc [m/min]	f [mm/tooth]	ap [mm]

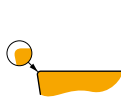

Zero rake geometry milling insert, can also be used for turning.

TPUN 110304	H10	0.4	–	–	–	–	–	–	–	90	0.10	0.8	–	–	–	–	–	–	–			
	M8330	0.4	–	–	–	–	–	–	–	150	0.10	1.2	–	–	–	–	–	–	30	0.15	1.0	
TPUN 110308	M8330	0.8	–	–	–	–	–	–	–	155	0.18	1.2	–	–	–	–	–	–	30	0.15	1.0	
TPUN 160304	8215	0.4	✓	155	0.15	4.0	–	–	–	✓	145	0.15	4.0	–	–	–	–	–	–	–	–	
	H10	0.4	–	–	–	–	–	–	–	✓	65	0.15	4.0	–	–	–	–	–	–	–	–	
	M8330	0.4	✓	155	0.15	4.0	–	–	–	✓	145	0.15	4.0	–	–	–	–	–	–	–	–	
	S26	0.4	✓	65	0.15	4.0	–	–	–	–	–	–	–	–	–	–	–	–	–	–	–	
TPUN 160308	8215	0.8	✓	185	0.15	4.0	–	–	–	✓	175	0.15	4.0	–	–	–	–	–	–	–	–	
	H10	0.8	–	–	–	–	–	–	–	✓	80	0.15	4.0	–	–	–	–	–	–	–	–	
	M8330	0.8	–	–	–	–	–	–	–	155	0.18	1.5	–	–	–	–	–	–	✓	30	0.15	1.0
	S26	0.8	✓	75	0.15	4.0	–	–	–	–	–	–	–	–	–	–	–	–	–	–	–	
TPUN 160312	M8330	1.2	–	–	–	–	–	–	–	155	0.20	1.5	–	–	–	–	–	–	✓	30	0.15	1.0
TPUN 220408	8215	0.8	✓	170	0.20	5.0	–	–	–	✓	160	0.20	5.0	–	–	–	–	–	–	–	–	
	M8330	0.8	✓	170	0.20	5.0	–	–	–	✓	160	0.20	5.0	–	–	–	–	–	–	–	–	
	S26	0.8	✓	70	0.20	5.0	–	–	–	–	–	–	–	–	–	–	–	–	–	–	–	
TPUN 220412	M8330	1.2	–	–	–	–	–	–	–	155	0.20	2.0	–	–	–	–	–	–	✓	30	0.15	1.0



VCGT 22-FA

PRAMET

	IC	D1	L	S
	[mm]	[mm]	[mm]	[mm]
2205	12.700	5.20	22.00	5.50

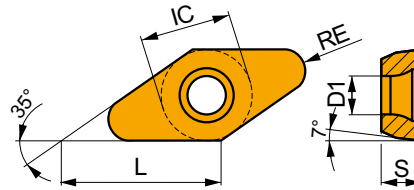

Suitability and starting values for cutting speed (vc), feed (f) and depth of cut (ap). Refer to our Machining Calculator app for further calculations.

Product	RE	P			M			K			N			S			H		
		vc	f	ap	vc	f	ap	vc	f	ap	vc	f	ap	vc	f	ap	vc	f	ap
	[mm]	[m/min]	[mm/tooth]	[mm]	[m/min]	[mm/tooth]	[mm]	[m/min]	[mm/tooth]	[mm]	[m/min]	[mm/tooth]	[mm]	[m/min]	[mm/tooth]	[mm]	[m/min]	[mm/tooth]	[mm]

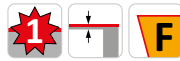
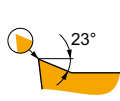

FA geometry with highly positive design for medium to rough machining.

VCGT 220515F-FA	HF7	1.5	–	–	–	–	–	–	–	–	–	–	–	–	–	–	–	–	–	–
VCGT 220520F-FA	HF7	2.0	–	–	–	–	–	–	–	–	–	–	–	–	–	–	–	–	–	–
VCGT 220530F-FA	HF7	3.0	–	–	–	–	–	–	–	–	–	–	–	–	–	–	–	–	–	–

XDHW

PRAMET

	IC	D1	L	S
	[mm]	[mm]	[mm]	[mm]
0702	6.500	2.95	6.90	2.38
10T3	10.000	3.95	10.60	3.97

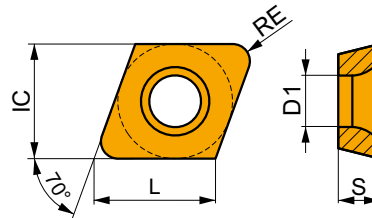

Suitability and starting values for cutting speed (vc), feed (f) and depth of cut (ap). Refer to our Machining Calculator app for further calculations.

Product	RE	P			M			K			N			S			H		
		vc	f	ap	vc	f	ap	vc	f	ap	vc	f	ap	vc	f	ap	vc	f	ap
	[mm]	[m/min]	[mm/tooth]	[mm]	[m/min]	[mm/tooth]	[mm]	[m/min]	[mm/tooth]	[mm]	[m/min]	[mm/tooth]	[mm]	[m/min]	[mm/tooth]	[mm]	[m/min]	[mm/tooth]	[mm]

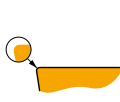

EN geometry with zero rake angle design for slot milling.

XDHW 070210EN	M8310	1.0	310	0.10	1.0	–	–	–	290	0.10	1.0	–	–	–	–	–	–	–	60	0.15	1.0
---------------	-------	-----	-----	------	-----	---	---	---	-----	------	-----	---	---	---	---	---	---	---	----	------	-----

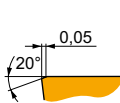

SN geometry with zero rake angle design for slot milling.

XDHW 070210SN	M8310	1.0	310	0.10	1.0	–	–	–	290	0.10	1.0	–	–	–	–	–	–	–	60	0.15	1.0
	M8325	1.0	230	0.10	1.0	–	–	–	–	–	–	–	–	–	–	–	–	–	–	–	–
XDHW 10T310SN	M8310	1.0	275	0.15	1.0	–	–	–	260	0.15	1.0	–	–	–	–	–	–	–	55	0.15	1.0
	M8325	1.0	210	0.15	1.0	–	–	–	–	–	–	–	–	–	–	–	–	–	–	–	–



INDEXABLE MILLS – TECHNICAL INFORMATION



WORKPIECE MATERIAL GROUP (WGM)

ISO To select a cutting grade and geometry for a broad range of workpiece materials

General definition
i.e. Steel, Stainless Steel...

P **M** **K** **N** **S** **H**

Subgroup To navigate and select a tool by suitability for a more specific range of workpiece materials

Definition by structure/composition
i.e. Plain Carbon Steel, Alloy Steel...

P **M** **K** **N** **S** **H**

P1

P2

P3

P4

WGM To select and provide cutting conditions within a bandwidth of $\pm 10\%$

Definition by hardness/ultimate tensile strength
i.e. $160 < 220$ HB, $620 < 900$ N/mm² ...

P

P1 **P1.1** **P1.2** **P1.3**

P2 **P2.1** **P2.2** **P2.3**

P3 **P3.1** **P3.2** **P3.3**

P4 **P4.1** **P4.2** **P4.3**

ABOUT DORMER PRAMET'S WORKPIECE MATERIAL CLASSIFICATION

Workpiece **Material Groups (WGM)** are used to support easy and reliable selection of the right cutting tool and starting values for machining conditions in particular applications.

Dormer Pramet classifies workpiece materials into six different coloured groups;

- **Blue:** Steel and cast steel (P-group)
- **Yellow:** Stainless steel (M-group)
- **Red:** Cast iron (K-group)
- **Green:** Non-ferrous metals (N-group)
- **Brown:** High-temperature alloys (S-group)
- **Grey:** Hardened materials (H-group)

Each of these are divided into subgroups on the basis of their structure and/or composition. For example, P-group steel and cast steel is split into four subgroups, namely;

- **P1** – Free machining steel
- **P2** – Plain carbon steel
- **P3** – Alloy steel
- **P4** – Tool steel

A final division includes material properties, such as hardness and ultimate tensile strength. This is to provide our customers with a complete tool recommendation, including starting values for cutting speed and feed.

The table on the next page includes a description of each workpiece material group, as well as examples of commonly used designations.

WORKPIECE MATERIAL GROUP (WMG)

ISO group	Subgroup	WMG (Work Material Group)	k_{vc}	Examples of material (AISI, EN, DIN, ČSN, GB, SS, STN, BS, UNE, AFNOR, ASTM, GOST, UNS, UNI, ...)
P Steel and cast steel (steels with alloy content ≤ 10 % and a hardness of < 45HRC)	P1 Free machining steel (carbon steels with increased machinability)	P1.1 Free machining sulfurized carbon steel with a hardness of < 220 HB	1.33	AISI 1108, EN 15522, DIN 1.0723, SS 1922, ČSN 11120, BS 210A15, UNE F.210F, GB Y15, AFNOR 10F1, GOST A30, UNI CF10S20
		P1.2 Free machining sulfurized and phosphorized carbon steel with a hardness of < 180 HB	1.49	AISI 1211, EN 115Mn30, DIN 1.0715, SS 1912, ČSN 11109, BS 230M7, UNE F.2111, GB Y15, AFNOR S250, GOST A40G, UNI CF95Mn28
		P1.3 Free machining sulfurized/phosphorized and leaded carbon steel with a hardness of < 160 HB	1.53	AISI 12L13, EN 115MnPb30, DIN 1.0718, SS 1914, ČSN 12110, BS 210M16, UNE F.2114, GB Y15Pb, AFNOR S250Pb, GOST A35G2, UNI CF10SPb20
	P2 Plain carbon steel (steels comprised of mainly iron and carbon)	P2.1 Plain low carbon steel containing < 0.25 % C with a hardness of < 180 HB	1.14	AISI 1015, EN C15, DIN 1.0401, SS 1350, ČSN 11301, BS 080A15, UNE F.111, GB 15, AFNOR C18RR, GOST S22ps, UNI Fe360
		P2.2 Plain medium carbon steel containing < 0.55 % C with a hardness of < 240 HB	1.00	AISI 1030, EN C30, DIN 1.0528, SS 1550, ČSN 12031, BS 080M32, UNE F.1130, GB 30, AFNOR AF50C30, GOST 30G, UNI Fe590
		P2.3 Plain high carbon steel containing > 0.55 % C, with a hardness of < 300 HB	0.89	AISI 1060, EN C60, DIN 1.0601, SS 1655, ČSN 12061, BS 080A62, UNE F.513, GB 60, AFNOR 1C60, GOST 60G, UNI C60
	P3 Alloy steel (carbon steels with an alloying content ≤ 10 %)	P3.1 Alloy steel with a hardness of < 180 HB	0.92	AISI 5015, EN 16Mo3, DIN 1.5415, SS 2912, ČSN 15020, BS 1501-240, UNE F.2601, GB 16Mo, AFNOR 15D3, GOST 15M, UNI 16Mo3KW
		P3.2 Alloy steel with a hardness of 180 – 260 HB	0.74	AISI 4140, EN 42CrMo4, DIN 1.7225, SS 2244, ČSN 15142, BS 708M40, UNE F.8232, GB 42CrMo, AFNOR 42CD4, GOST 40CHFA, UNI 42CrMo4
		P3.3 Alloy steel with a hardness of 260 – 360 HB	0.63	AISI 4140, EN 42CrMo4, DIN 1.7225, SS 2244, ČSN 15142, BS 708M40, UNE F.8232, GB 42CrMo, AFNOR 42CD4, GOST 40CHFA, UNI 42CrMo4
	P4 Tool steel (special alloy steel for tools, dies and molds)	P4.1 Tool steel with a hardness of < 26 HRC	0.55	AISI D2, EN X155CrVMo12-1, DIN 1.2370, SS 2736, ČSN 19573, BS BD2, UNE F.520A, GB Cr12Mo1V1, AFNOR Z160CDV12, GOST Ch12MF, UNI X155CrVMo121KU
		P4.2 Tool steel with a hardness of 26 – 39 HRC	0.47	AISI D2, EN X155CrVMo12-1, DIN 1.2370, SS 2736, ČSN 19573, BS BD2, UNE F.520A, GB Cr12Mo1V1, AFNOR Z160CDV12, GOST Ch12MF, UNI X155CrVMo121KU
		P4.3 Tool steel with a hardness of 39 – 45 HRC	0.38	AISI D2, EN X155CrVMo12-1, DIN 1.2370, SS 2736, ČSN 19573, BS BD2, UNE F.520A, GB Cr12Mo1V1, AFNOR Z160CDV12, GOST Ch12MF, UNI X155CrVMo121KU



WORKPIECE MATERIAL GROUP (WMG)

ISO group	Subgroup	WMG (Work Material Group)	k_{vg}	Examples of material (AISI, EN, DIN, ČSN, GB, SS, STN, BS, UNE, AFNOR, ASTM, GOST, UNS, UNI, ...)
M Stainless steel (corrosion resistant steels with $\geq 11\%$ chromium content)	M1 Ferritic stainless steel (straight chromium non-hardenable alloys)	M1.1 Stainless steel, ferritic with a hardness of < 160 HB	1.22	AISI 5429, EN X7Cr14, DIN 1.4001, SS 2326, BS 434517, UNE F.3401, AFNOR Z8C12, GOST 08Ch13, UNI X6CrTi12
		M1.2 Stainless steel, ferritic with a hardness of 160 – 220 HB	1.03	AISI 446, EN X10CrAl24, DIN 1.4762, SS 2322, ČSN 17113, BS 430517, UNE F.3154, GB 10Cr17, AFNOR Z10CA524, GOST 12Ch17, UNI X16Cr26
		M2.1 Stainless steel, martensitic with a hardness of < 200 HB	1.08	AISI 430F, EN X14CrMo517, DIN 1.4104, SS 2383, ČSN 17140, BS 410521, UNE F.3117, AFNOR Z10CF17, UNI X10Cr517
	M2 Martensitic stainless steel (straight chromium hardenable alloys)	M2.2 Stainless steel, martensitic with a hardness of 200 – 280 HB	0.89	AISI 440C, EN X105CrMo17, DIN 1.4125, SS 2385, ČSN 17023, BS 425C11, UNE F.3402, GB 102Cr17Mo, AFNOR Z100CD17, GOST 95Ch18, UNI GX6CrNi 13 04
		M2.3 Stainless steel, martensitic with a hardness of 280 – 380 HB	0.75	AISI 420, EN X45Cr13, DIN 1.4034, ČSN 17029, BS 425C11, UNE F.3405, AFNOR Z44C14, GOST 20X17H12, UNI X30Cr13
		M3.1 Stainless steel, austenitic with a hardness of < 200 HB	1.00	AISI 304, EN X5CrNi18-12, DIN 1.4303, SS 2352, ČSN 17249, BS 305517, UNE F.3513, GB 10Cr18Ni12, AFNOR Z8CN18.12, UNI X7CrNi18 10
	M3 Austenitic stainless steel (chromium-nickel and chromium-nickel-manganese alloys)	M3.2 Stainless steel, austenitic with a hardness of 200 – 260 HB	0.86	AISI 309, EN X15CrNiSi20-12, DIN 1.4828, ČSN 17251, BS 309S24, UNE F.3312, GB 1G23Ni13, AFNOR Z15CNS20.12, GOST 20Ch20Ni452, UNI 16CrNi23 14
		M3.3 Stainless steel, austenitic with a hardness of 260 – 300 HB	0.77	AISI 5848, EN X45CrNiW18-9, DIN 1.4873, BS 331540, UNE F.3211, AFNOR Z35CNW514-4, UNI X45CrNiW 18 9
		M4 Super-austenitic, Duplex or Precipitation Hardening stainless steel (austenitic alloys with $> 20\%$ Ni, austenitic-ferritic microstructure or precipitation hardened)	M4.1 Stainless steel, austenitic-ferritic or super-austenitic with a hardness of < 300 HB	0.75
	M4.2 Stainless steel, precipitation hardening austenitic with a hardness of 300 – 380 HB		0.64	AISI 631 (17-7PH), EN X7CrNiAl17-7, DIN 1.4568, SS 2388, ČSN 17465, BS 301513, UNE F.3217, GB 07Cr17Ni7Al, AFNOR Z9CNAl17-07, GOST 09Ch17Ni7Al, UNI X53CrMnNi21 9



WORKPIECE MATERIAL GROUP (WMG)

ISO group	Subgroup	WMG (Work Material Group)	k_{wc}	Examples of material (AISI, EN, DIN, ČSN, GB, SS, STN, BS, UNE, AFNOR, ASTM, GOST, UNS, UNI, ...)
K Cast Iron (castings of iron and carbon alloys with > 2 % carbon content)	K1 Gray iron (GG) (iron-carbon castings with a lamellar graphite microstructure)	K1.1 Gray iron, ferritic or ferritic-pearlitic with a hardness of < 180 HB	1.35	ASTM A48 Grade 20 (F11401), EN-JL-100, DIN GG-10 (0.6010), SS 0110, STN 422410, BS Grade 150, UNE FG10, GB HAT 100, AFNOR Fc10D, GOST SC 10, UNI G10
		K1.2 Gray iron, ferritic-pearlitic or pearlitic with a hardness of 180 – 240 HB	1.00	ASTM A48 Grade 30 (F12101), EN-JL-1030, DIN GG-20 (0.6020), SS 0120, STN 422420, BS Grade 220, UNE FG20, GB HT200, AFNOR Fc20D, GOST Ч420, UNI G20
		K1.3 Gray iron, pearlitic with a hardness of 240 – 280 HB	0.75	ASTM A48 Grade 50 (F13501), EN-JL-1060, DIN GG-35 (0.6035), SS 0135, STN 422435, BS Grade 350, UNE FG35, GB HAT300, AFNOR Fc35D, GOST SC35, UNI G35
	K2 Malleable iron (GTS/GTW) (heat-treated iron-carbon castings with a graphite-free microstructure)	K2.1 Malleable iron, ferritic with a hardness of < 160 HB	1.39	ASTM A602 Grade M3210 (F20000), EN-JM-1130, DIN GTS-35 (0.8135), SS 0815, BS B340/12, UNE Type A, AFNOR MN 35-10, GOST K435-10
		K2.2 Malleable iron, ferritic or pearlitic with a hardness of 160 – 200 HB	1.13	ASTM A602 Grade M4504 (F20001), EN-JM-1040, DIN GTS-50-05 (0.8045), BS P50-05, AFNOR MB 45-7
		K2.3 Malleable iron, pearlitic with a hardness of 200 – 240 HB	0.90	ASTM A602 Grade M7002 (F20004), EN-JM-1140, DIN GTS-45 (0.8145), SS 0854, STN 422540, BS P 45-06, UNE Typ B, AFNOR MP 50-5, GOST K445-7, UNI GMN 45
	K3 Ductile iron (GGG) (iron-carbon castings with a nodular graphite microstructure)	K3.1 Ductile (nodular/spheroidal) iron, ferritic with a hardness of < 180 HB	1.23	ASTM A536 Grade 60-40-18 (F32800), EN-JS-1030, DIN GGG-40 (0.7040), SS 0717, STN 422304, BS 420/12, UNE FGE 42-12, GB QT 400, AFNOR FGS 400-12, GOST B440
		K3.2 Ductile (nodular/spheroidal) iron, ferritic or pearlitic with a hardness of 180 – 220 HB	0.94	ASTM A536 Grade 80-55-06 (F33800), EN-JS-1050, DIN GGG-50 (0.7050), SS 0727, STN 422305, BS 500/7, UNE FGE 50-7, GB QT 500-7, AFNOR FGS 500-7, GOST B450
		K3.3 Ductile (nodular/spheroidal) iron, pearlitic with a hardness of 220 – 260 HB	0.76	ASTM A536 Grade 100-70-03 (F34800), EN-JS-1060, DIN GGG-60 (0.7060), SS 0732, STN 422306, BS 600/3, UNE FGT-2, GB QT 600-3, AFNOR FGS 600-3, GOST B460
	K4 Austenitic or austempered ductile iron (NI-Resist/ADI) (iron-carbon alloy castings with an austenitic or ausferrite microstructure)	K4.1 Austenitic cast iron with a hardness of < 180 HB	1.14	ASTM A436 Type 1 (L-NiCuCr 15 6 2, F41000), EN-JL-3011, DIN GGL-NiMn 13 7 (0.6652), SS 0523, BS Grade F1, AFNOR FGL-Ni13Mn7, GOST S-NiMn 13 7
		K4.2 Austenitic cast iron with a hardness of 180 – 240 HB	0.86	ASTM A439 Type D-2B (S-NiCr 20 3, F43001), EN-JS-3021, DIN GGG-NiMn 23 4, SS 0776, BS Grade S2M, AFNOR FGS Ni23 Mn4, GOST ЧН19Х3U
		K4.3 Austempered ductile iron with a hardness of 240 – 280 HB	0.63	ASTM A897 Grade 110-70-11
K5 Compacted graphite iron (CGI) (iron-carbon castings with a vermicular graphite structure)	K4.4 Austempered ductile iron with a hardness of 280 – 320 HB	0.54	ASTM A897 Grade 125-80-10, EN-JS-1100, DIN GGG-90 (5.3400)	
	K4.5 Austempered ductile iron with a hardness of 320 – 360 HB	0.45	ASTM A897 Grade 2 (150-110-07), EN-JS-1110, DIN GGG-100 (5.3403)	
	K5.1 Vermicular, compacted graphite iron with a hardness of < 180 HB	1.29	ASTM A842 Grade 300, EN-GJV-300, DIN GGV 30, GOST ЧВТ30,	
K5.2 Vermicular, compacted graphite iron with a hardness of 180 – 220 HB	K5.2 Vermicular, compacted graphite iron with a hardness of 180 – 220 HB	0.97	ASTM A842 Grade 350, EN-GJV-350, DIN GGV 35 (5.2200), GOST ЧВТ30,	
	K5.3 Vermicular, compacted graphite iron with a hardness of 220 – 260 HB	0.75	ASTM A842 Grade 450, EN-GJV-450, DIN GGV 45, GOST ЧВТ45,	



WORKPIECE MATERIAL GROUP (WMG)

ISO group	Subgroup	WMG (Work Material Group)	k_{vg}	Examples of material (AISI, EN, DIN, ČSN, GB, SS, STN, BS, UNE, AFNOR, ASTM, GOST, UNI, ...)
N Non-ferrous metals (metals including alloys without an appreciable amount of iron)	N1 Wrought aluminium	N1.1 Pure aluminium and wrought aluminium alloys with a hardness of < 60 HB	1.33	UNS A91200, EN AL99.6, DIN 3.0205, SS 4010, STN 424009, BS 1C, UNE L-3001, GB L5, AFNOR A4, GOST AĐC, UNI 3567
		N1.2 Wrought aluminium alloys with a hardness of 60 – 100 HB	1.00	UNS A93004, EN AlMn0.5Mg0.5, DIN 3.0505, SS 4054, STN 424432, BS N31, UNE L-3831, GB LF2, AFNOR A-M1, GOST AMu, UNI 3568
		N1.3 Wrought aluminium alloys with a hardness of 100 – 150 HB	0.67	UNS A95083, EN AlMg4.5Mn0.7, DIN 3.3547, SS 4140, STN 424415, BS N8, UNE L-3321, GB AlMg4.5Mn, AFNOR A-G4.5Mn, GOST Amg 4.5, UNI P-AlMg4.4
	N2 Cast aluminium	N2.1 Cast aluminium alloys with a hardness of < 75 HB	0.67	UNS A02080, EN AlCu45, BS LM11, STN 424331, UNE AlSi1Cu, GOST AMg5K, UNI G-AlSi7Mg
		N2.2 Cast aluminium alloys with a hardness of 75 – 90 HB	0.60	UNS A02420, EN AlCu4Ni2Mg2, SS AlSi7MgFe, BS LM6, STN 424519, UNE Al-7SiMg, AFNOR A-S7G, GOST AK7, UNI G-AlSi7Mg
		N2.3 Cast aluminium alloys with a hardness of 90 < 140 HB	0.43	UNS A03360, EN G-ALCu4NiMg2, SS AlSi10Mg, STN 424336, BS LM 30, AFNOR A-S10G, UNI G-AlSi9Mg
	N3 Copper or copper alloys	N3.1 Free-cutting copper-alloys materials with excellent machining properties	0.70	UNS C14700, EN CuPb1P, DIN 2.1498, STN 423214, BS C111, AFNOR CuZn35Pb2, GOST L63-3, UNI CuS(P0.01)
		N3.2 Short-chip copper-alloys with good to moderate machining properties	0.41	UNS C81540, EN CuNi25Cr, DIN 2.0857, STN 423220, BS NS113, UNE CuSn12, AFNOR CuZn40, GOST L60, UNI P-CuZn-40
		N3.3 Electrolytic copper and long-chip copper-alloys with moderate to poor machining properties	0.21	UNS C10100, EN CuAg0.1, DIN 2.1203, SS 5010, UNE CUSi3Mn1, AFNOR Cu-C2, GOST M1f, UNI Cu-0F
	N4 Polymers (synthetic or semi-synthetic materials)	N4.1 Thermoplastic polymers	0.70	ABS, Acryl, Duraplast, Elastomer, EP, Epoxid, FEP, Fluor, Gummi, Kautschuk, Latex, ME, MPF, PA, PC, PE, PEEK, PEI, PES, PET, PF, Phenolharze, PI, PMMA, Polyamide, Polyester, Polyolefine, Polysulfon, POM, PP, PPE, PPS, PS, PSU, PTFE, PU, PUR, PVDF, SAN, SI, Styrol, UF, Ureol
		N4.2 Thermosetting polymers	0.27	Aramid, Epoxy, Fluoropolymer, Methacrylate, Melamine, Phenolic, Polyester, Polyimide, Polymethacrylimide, Polyurethane
		N4.3 Reinforced polymers or composites	0.29	CFK, GFK, GMT, Honeycomb, Kevlar, LFT, Organo, SMC
	N5 Graphite	N5.1	1.0	CGM-1, CM-00, GM-10, GM-11, GR030, GR030PI, GR060, GR060PI, GR125, MC-01, MC-01R0, MC-03, MC-03M, IG11, IG-15, IG-32, IG-43, IG-45, IG-70, ISEM-1, ISEM-2, ISEM-3, R8340, R8500X, Technograph 15, Technograph 30, ISO-63, EDM C-3, EDM1, EDM3, ISO-90, ISO-93, ISO-95, R8510, R8650, R8650



WORKPIECE MATERIAL GROUP (WMG)

ISO group	Subgroup	WMG (Work Material Group)	$k_{w,c}$	Examples of material (AISI, EN, DIN, ČSN, GB, SS, STN, BS, UNE, AFNOR, ASTM, GOST, UNS, UNI, ...)
S High-temperature alloys (superalloys with high temperature strength and corrosion resistant surpassing that of stainless steel)	S1 Titanium or titanium alloys	S1.1 Titanium or titanium alloys, with a hardness of <200 HB	1.94	UNS R50250 (Grade 1), EN Ti 99.6, DIN 3.7035, BS TA.2, UNE Ti-Po2, AFNOR T-40, GOST BT1-00, AISI R50250, 3.7025, T35, 2TA1, R50400, 3.7035, 2TAZ,
		S1.2 Titanium alloys, with a hardness of 200 – 280 HB	1.72	UNS R56404 (Grade 29), EN Ti2Cu, DIN 3.7124, BS TA.21, UNE Ti-P11, AFNOR T-U2, AISI TA6V, Ti-6Al-4V, Ti 10.2.3, Ti5553
		S1.3 Titanium alloys, a hardness of 280 – 360 HB	1.44	UNS R54250 (Grade 38), EN TiAl6V4, DIN 3.7165, ČSN TiAl6VELI, BS TA. 13, UNE Ti-P63, AFNOR T-A6V, GOST BT6, AISI TA6V, Ti-6Al-4V, Ti 10.2.3, Ti5553
	S2 Fe-based high-temperature alloys	S2.1 High-temperature Fe-based alloys with a hardness of <200 HB	1.33	UNS N08801 (Incoloy 801), EN X8 NiCrAlTi31-21, DIN 1.4959, BS NA 15, AFNOR Z8NC33-21, AISI A-286, Discaloy, Haynes 556, Inconel 909, Greek Ascology
		S2.2 High-temperature Fe-based alloys with a hardness of 200 – 280 HB	1.17	UNS N19907, EN X6NiCrTiMoVB25-15-2, DIN 1.4980, SS 2570, BS HR52, AFNOR Z6NCTDV25.15B, GOST 36HXT10, AISI A-286, Discaloy, Haynes 556, Inconel 909, Greek Ascology
		S3.1 High-temperature Ni-based alloys with a hardness of <280 HB	1.00	UNS A09706 (Inconel 706), EN NiCr25FeAl, DIN 2.4856, BS HR 6, ČSN Inconel 625, UNE F.3313, GB 1Cr16Ni35, AFNOR NC22FeDNB, GOST XH38BT, AISI Inconel 718, 706 Waspalloy, Udimet 720, Inconel 625
	S3 Ni-based high-temperature alloys	S3.2 High-temperature Ni-based alloys with a hardness of 280 – 360 HB	0.83	UNS N07001, EN NiCr20Co13Mo4Ti3Al, DIN 2.4654, BS HR 2, ČSN Waspalloy, AFNOR NCKD 20ATV, GOST XH80T5K0, AISI Inconel 718, 706 Waspalloy, Udimet 720, Inconel 625
		S4 Co-based high-temperature alloys	S4.1 High-temperature Co-based alloys with a hardness of <240 HB	0.78
	S4.2 High-temperature Co-based alloys with a hardness of 240 – 320 HB		0.67	UNS R30016 (Stellite 6b), EN CoCr20W15Ni, DIN 2.4964, AFNOR KC 20 WN, GOST ЛК52, AISI Haynes 25, Stellite 21, 31







WORKPIECE MATERIAL GROUP (WMG)

ISO group	Subgroup	WMG (Work Material Group)	k_{vg}	Examples of material (AISI, EN, DIN, ČSN, GB, SS, STN, BS, UNE, AFNOR, ASTM, GOST, UNS, UNI, ...)
H Hardened materials (any engineering metal with a hardness > 45 HRC)	H1 Chilled cast iron	H1.1 Chilled cast iron with a hardness of < 440 HB	1.52	UNS F45001, EN-GJS-1050-6, DIN 5.3406, SS 0512, BS Grade 2A
		H2.1 Hardened cast iron with a hardness < 55 HRC	0.90	UNS F45003, EN-GJS-1400-1, DIN 5.3405, SS 0457, BS Grade 3D
	H2 Hardened cast iron	H2.2 Hardened cast iron with a hardness > 55 HRC	0.77	UNS F45003, EN G-X260NiCr4-2, DIN 0.9620, SS 0466, BS Grade S
		H3.1 Hardened steel with a hardness of < 51 HRC	1.00	AISI 4135, EN 34CrMo4, DIN 1.7220, SS 2234, STN 415131, BS 198, UNE F.1250, GB 35CrMo, AFNOR 35CD4, GOST AC38XTM, UNI 35CrMo4KB
	H3 Hardened steel < 55 HRC	H3.2 Hardened steel with a hardness of 51 – 55 HRC	0.82	AISI 4135, EN 34CrMo4, DIN 1.7220, SS 2234, STN 415131, BS 198, UNE F.1250, GB 35CrMo, AFNOR 35CD4, GOST AC38XTM, UNI 35CrMo4KB
		H4 Hardened steel > 55 HRC	H4.1 Hardened steel with a hardness of 55 – 59 HRC	0.64
	H4.2 Hardened steel with a hardness of > 59 HRC		0.54	UNS T31501, EN 100MnCrW4, DIN 1.2510, SS 2140, STN 419413, BS B01, UNE F.5220, GB 9CrWMn, AFNOR 90MnWCrV5, GOST 9XBТ, UNI 95MnWCr5KU



CORRECTION FACTORS

Correction factors for specific type of cutter and operation C_{VCO}

			
Face mills with $KAPR 45^\circ - 60^\circ$ and negative inserts (SHN06C, SHN09C, CHN09, ...)	1.15	1.00	0.85
Face mills with $KAPR 45^\circ$ and positive inserts (SOE06Z, SOE09Z, SOD05, ...)	1.15	1.00	0.85
Shoulder mills with $KAPR 90^\circ$ (SAD07D, SAD11E, SAD16E, SLN12, SLN16..)	1.10	1.00	0.90
Copy face mills (SRC10 - SRC20, SRD05 - SRD16, ...)	1.10	1.00	0.90
Copy end mills (K2-PPH, K2-SLC, K2-SRC, K3-CXP...)	1.10	1.00	0.90
Disc mills (S90CN(XN), S90SN...)	1.10	1.00	0.90
Shoulder mills with extended flute J(T)-CSD12X, J(T)-SAD11E, J(T)-SAD16E...)	1.25	1.00	0.80
Face mills for heavy duty (FSB22X, SPN13..)	1.30	1.00	0.85
Shoulder mills for heavy duty (FTB27X..)	1.25	1.00	0.85

Correction factors for required durability C_{VCT}

 minutes	15	20	30	45	60	90	120
General machining operations (fine finishing up to roughing)	1.23	1.13	1.00	0.89	0.81	0.72	–
Heavy machining operations (heavy roughing)	–	–	1.23	1.13	1.00	0.89	0.81



Additional correction factors C_{VCA}

Machining environment	C_{VCA}
Condition of the work-material (hard skin due to forging or casting)	0.70
Unstable machining conditions	0.85
Common machining conditions	1.00
Stable machining conditions	1.20

Correction factors for cutting speed when face and shoulder milling with <100% radial immersion C_{VCRCT}

a_e / DC	5 %	10 %	15 %	20 %	25 %	30 %	40 %	50 %	60 %	70 %	75 %	80 %	90 %	100 %
	1.48	1.35	1.27	1.22	1.19	1.16	1.11	1.08	1.05	1.03	1.00	1.00	1.00	1.00

Correction factors to compensate for chip-thinning when face and shoulder milling with <100% radial immersion C_{fzRCT}

a_e / DC	5 %	10 %	15 %	20 %	25 %	30 %	40 %	50 %	60 %	70 %	75 %	80 %	90 %	100 %
	2.20	1.60	1.35	1.20	1.10	0.95	0.85	0.75	0.85	0.95	1.00	1.00	1.00	1.00
	0.64	0.64	0.64	0.64	0.64	0.65	0.65	0.67	0.68	0.71	0.72	0.74	0.79	1.00

Resulting corrected cutting speed v_{cc}

$$v_{cc} = v_c \cdot kvG \cdot C_{VCO} \cdot C_{VCT} \cdot C_{VCA} \cdot C_{VCRCT} \cdot C_{fzRCT}$$

kvG - coefficient of used material

v_c - starting speed from catalogue page

Parts of an Indexable Insert

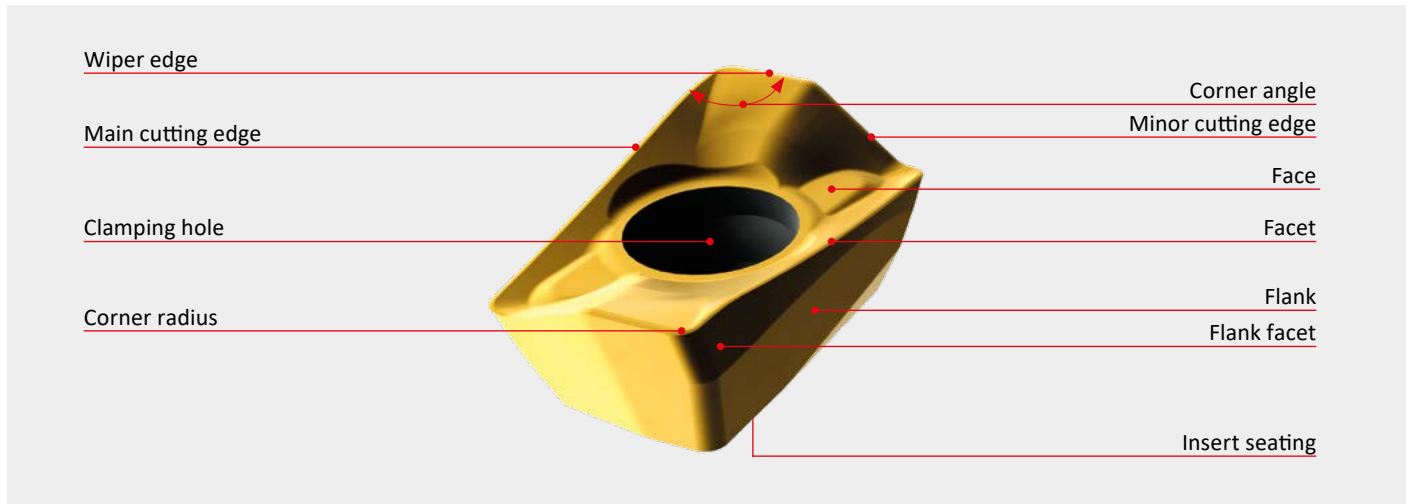

Geometry of milling tool

Constructional angles determine the basic orientation of the seat position that the cutting insert is clamped in and are therefore important for the design of the milling cutter body. There are two angles: axial face angle $GAMP - \gamma_p$ (tool back rake) and radial face angle $GAMF - \gamma_f$ (tool side rake) – see picture below.

Working angles are the setting angle $KAPR - \kappa_r$, the orthogonal face angle $GAMO - \gamma_o$ and the rake angle of the cutting edge $LAMS - \lambda_s$.

- **Orthogonal face angle $GAMO - \gamma_o$** affects not only the extent of plastic deformation of the cut chip but also the cutting force and temperature. The bigger the rake angle $GAMO - \gamma_o$, the lower the cutting force and power demand of the spindle motor (and vice versa).
- **Setting angle $KAPR - \kappa_r$** determines the thickness of the chip at a specific feed per tooth f_z and axial depth of cut a_p . It therefore affects cutting forces, specifically load, wear and tool service life.

Reducing the setting angle $KAPR - \kappa_r$ at a constant feed f_z causes a decrease in the chip thickness h .

- **Rake angle of cutting edge $LAMS - \lambda_s$** together with setting angle $KAPR - \kappa_r$ and face angle $GAMO - \gamma_o$, this determines the point of first contact between the edge and work piece. That is why it affects the resistance of the edge to chipping during interrupted cut. At the same time, it affects the direction of chip evacuation.

Working angles of the tool you can determine the bed using the formulas or diagrams below.

Working and constructional angles of milling tool

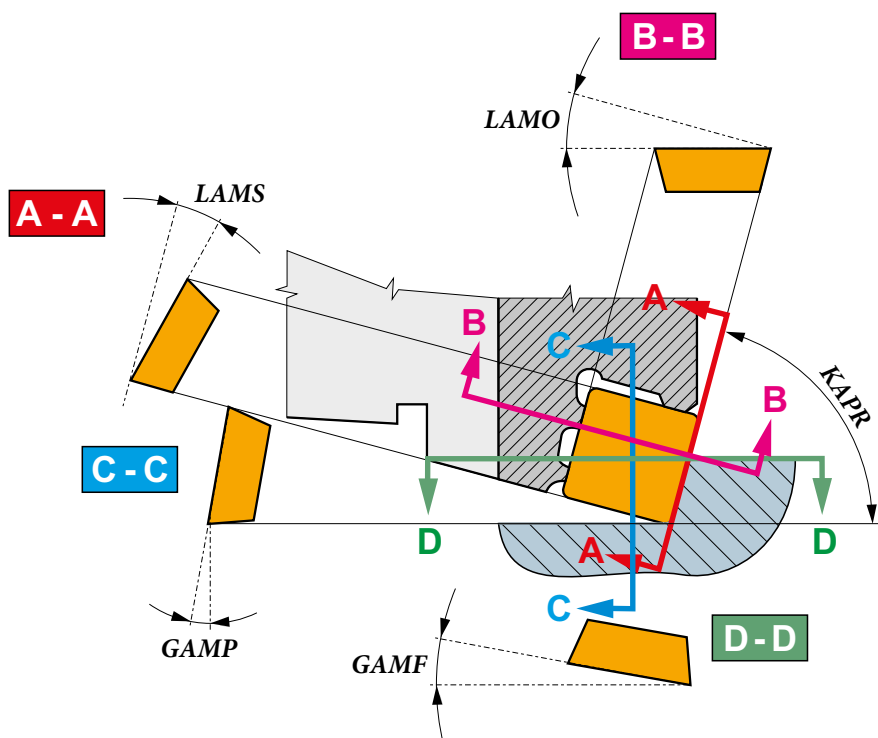



NOMOGRAM FOR CALCULATING THE WORKING GEOMETRY OF MILLING TOOL

Nomogram for calculating the working geometry of mills

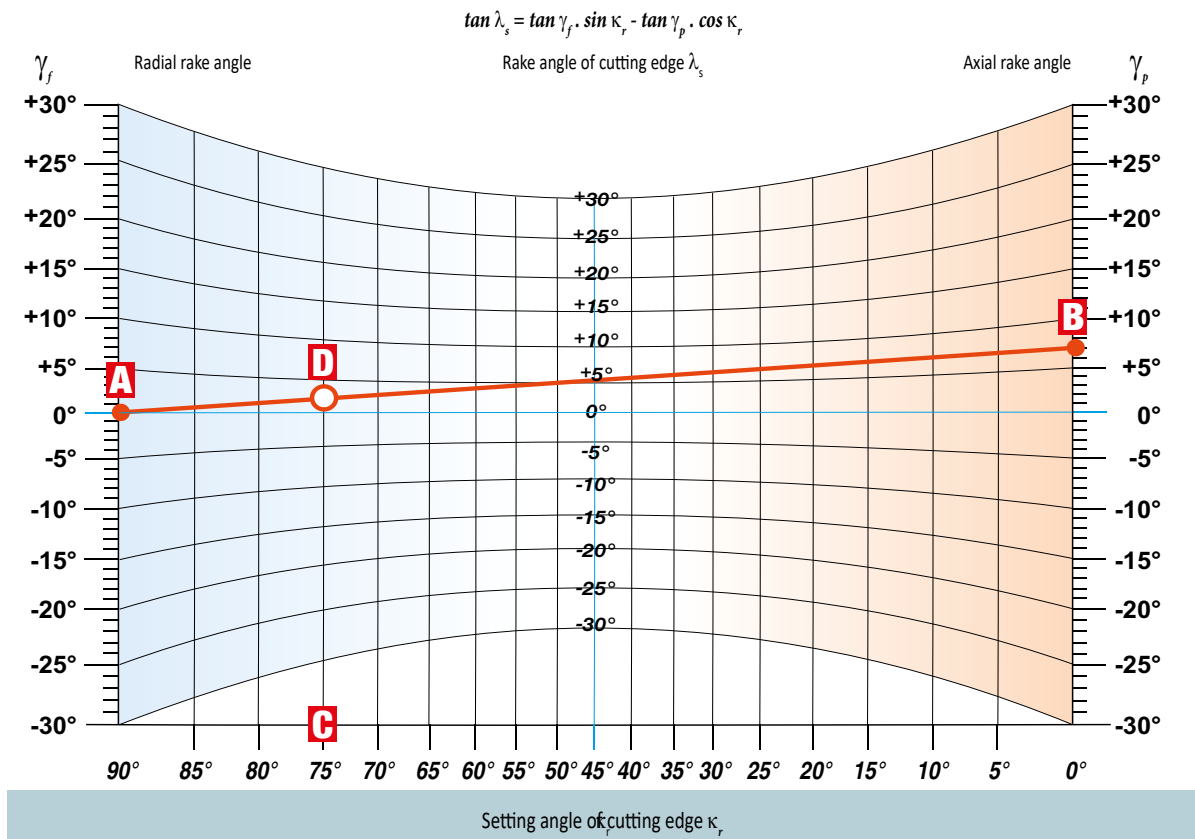
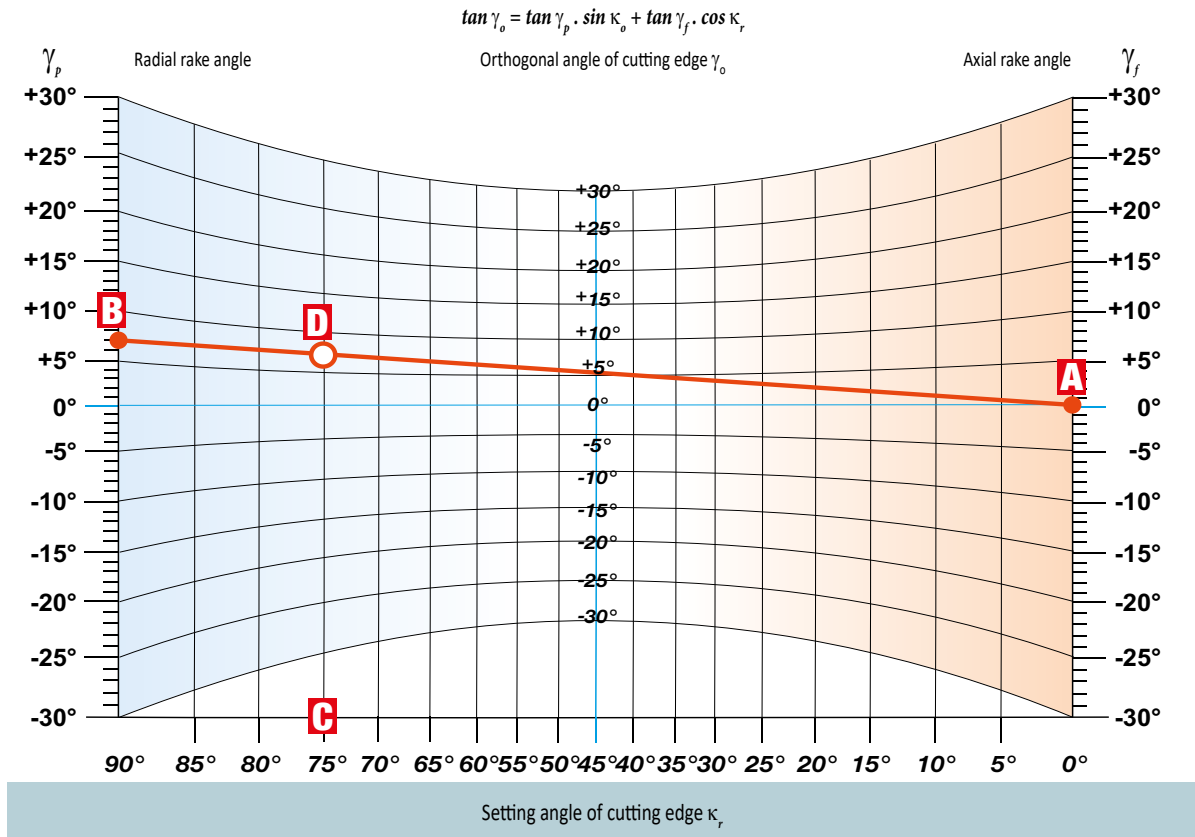



NOMOGRAM FOR CALCULATING THE WORKING GEOMETRY OF MILLING TOOL

The exiting of the cutting edge from the cut is also accompanied by thermal stress, caused by a rapid reduction in temperature of the surface layer of the cutting edge and mechanical stress caused by elastic deformation relief of the surface layer of workpiece at a rapid drop in cutting force.

That is why we use the average value of chip thickness h_m for any calculations.

The chip thickness h fluctuates during one revolution depending on angle φ in accordance with the formula $h\varphi = f_z \times \sin\varphi$.

The maximum chip thickness equal to f_z is reached at the axis of the milling cutter. The average chip thickness h_m cut by one tooth during one revolution is equal to the height of the rectangle of the same area as the area under the sine curve relates to the radial depth of cut a_e .

The average chip thickness h_m depends on the type of milling cutter and the cutting conditions, especially on the relation a_e/DC , feed per tooth f_z and the setting angle $KAPR - \kappa_r$. See picture on the next page for an illustrative example.

Milling Cutter Geometry

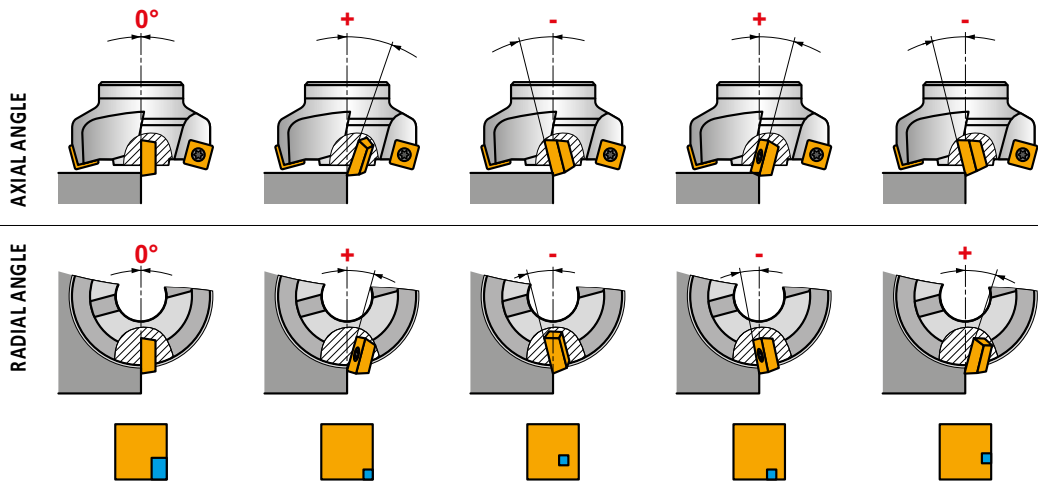

When choosing a tool, it is necessary to take many criteria into account. One of the primary requirements is that the place of first contact between the cutting wedge and the workpiece lie further away from the tip and the cutting edge. That, however, is dependent on the basic geometry of the cutting wedge i.e. angles $GAMO - \gamma_o$, $LAMS - \lambda_s$, $KAPR - \kappa_r$, as well as the mutual position of the milling cutter and the entry edge of the workpiece. The following figure shows individual milling cutter geometries (or rather, the combinations of radial and axial angles) at some of the most adverse engagement conditions (i.e. when the axis of the milling cutter is in line with the edge of the workpiece). At the bottom of the figure is a depiction of the indexable insert with an indication of the area where the insert makes first contact with the workpiece. The figure shows that in such adverse engagement conditions, tools with negative - negative

geometry perform the best, while tools with positive - positive geometry will be the most problematic. Another criterion is chip removal. Negative - negative tools push the chip into the work surface (towards the workpiece) while positive - positive tools do the opposite, leading the chip away from the work surface, i.e. away from the workpiece. It is thus an optimal compromise to combine negative and positive angles.

Entering Angle

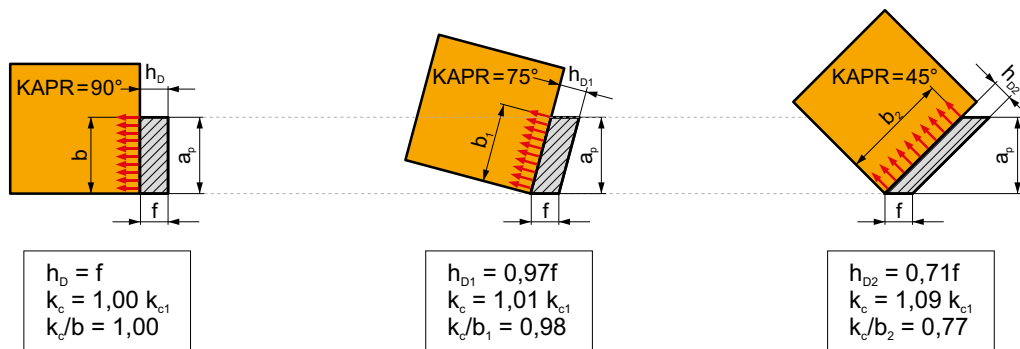

When choosing the entering angle for face milling, you should, among other things, account for the power and rigidity of the machine (size and type of tool holder), its dynamic capabilities and maximum depth of removal. For instance, if you have a high-performance (50 – 100 kW) machine at your disposal with an ISO 50 tool holder and you cut at high depth, your first choice should be a milling cutter with an entering angle between $90^\circ - 58^\circ$. On the other hand, if you have a low-power machine (up to 10 kW) with an ISO 40 (HSK 63) tool holder and you expect to cut at 2 – 3 mm depth, you should choose a tool with an entering angle of $45^\circ - 10^\circ$ (i.e. HFC) or with round inserts. It would thus be an ideal compromise to choose a tool with an entering angle of 45° , which can also handle higher depths of cut and, when compared to a tool with an entering angle of 90° , can cut at the same depth at up to 30 % higher feed and at approximately the same load.

Finally, it is important to emphasise that the lower the entering angle, the thinner the chip and the longer the engaged section of the cutting wedge, which is important with regard to heat dissipation and the distribution of force across the edge of the insert. Also worth mentioning is the change in the direction of the resultant cutting forces, which, in simplified terms, can be visualised as perpendicular to the edge. (Decreasing the entering angle increases the passive component of the cutting force leading into the spindle and decreases the active radial component of the cutting force).



CHOICE OF TOOL

The following figure shows the assortment of Pramet milling cutters with regard to the entering angle and the basic geometry of the cutter body (i.e. the axial and radial angle of the face). However, it must be pointed out that insert geometry may change the resulting geometry of the tool as indicated in the following figure.

	Negative – Negative	← Negative – Positive	→ Positive – Positive
93°	 SWN04C SCN05C		
90°	 STN10 STN16 SLN12 SLN16 J(T)-SLSN	 SAD07D SAD11E SAD16E SAP10D SAP16D FTB27X SSD12 SS009 SS0050 J(T)-SAD11E S90SN S90CN(XN) F-SCC J(T)-SAD16E J(T)-CSD12X J(T)-SSAP	 SAP10D J(T)-2416 SVC22C
60°	 CNH09	 FSB22X	
57°	 SPN13		
45°	 SHN06C SHN09C SSD09 N-SS009 Z516	 SOD05 SOD06D SSE09 SSN12Z	
43°			 SOE06Z SOE09Z
20°	 SBN10		
19°		 SPD09	
18°	 SSN11		
1°	 SRC10 SRC12 SRC16 SRC20 SRD10 SRD12 L2-SZP K3-CXP K2-PPH K2-SLC K2-SRC	 SRD05 SRD07 SRD10 SRD12 SRD16 SZD07 SZD09 SZD12 2636 J(T)-SXP16	

Resulting Geometry (Milling Cutter + Indexable Insert)

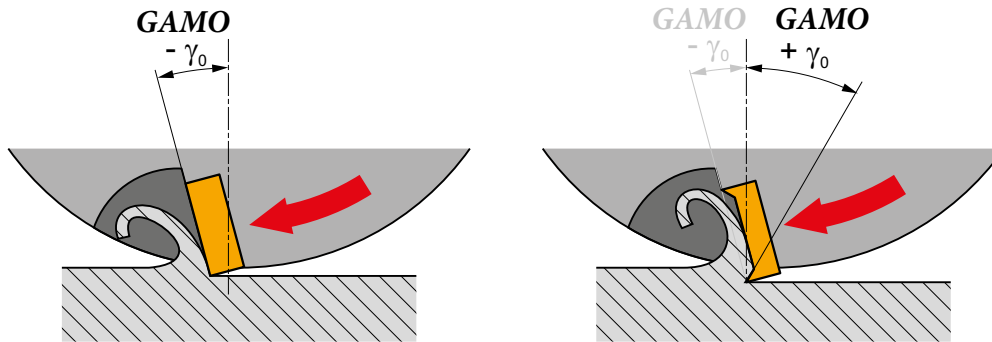







The following table lists the three basic milling cutter geometries and the approximate priority of their use with regard to the type of machined material. More detailed information about individual tool families with consideration of insert geometries can be found in the catalogue section.

Conditions		Selection of cutter geometry according to application		
		Negative – Negative	Negative – Positive	Positive – Positive
Structural parameter of the body	GAMP (A.R.)	-	+	+
	GAMF (R.R.)	-	-	+
	GAMO	-	+	+
Machined material	Carbon steels, alloy steels (< 300 HB)	▣	■	■
	Stainless steels (< 300 HB)		■	▣
	Stainless steels (> 300 HB)		■	▣
	Cast iron, ductile iron	■	▣	▣
	Al alloys		▣	■
	Copper and its alloys		▣	■
	Titanium and its alloys		▣	▣
	Hardened steels (40 – 55 HRC)	▣	▣	

Number of Teeth on the Milling Cutter

The number of teeth on the milling cutter is also important in relation to the width of the milled surface, where it determines the force (and acoustic) characteristics of the cut, as indicated in the following figure.

			
Feed per minute	+	++	+++
Tough materials	+++	++	+
Power requirement	+	++	+++
Resulting roughness	+++	++	+
			



Tooth Pitch

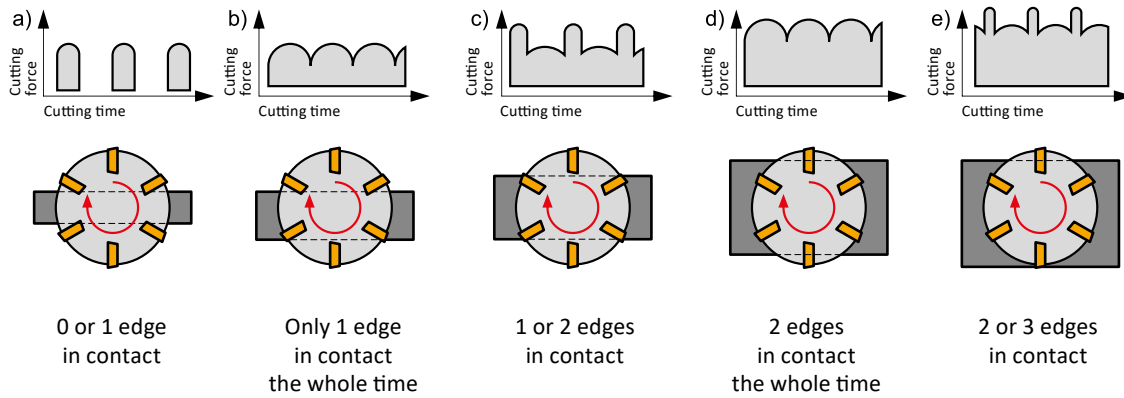

In addition, some tool families offer the option to choose between even and uneven tooth pitch. Using a tool with an uneven tooth pitch interferes with harmonic oscillation and, as a result, helps improve stability and reduce the risk of vibration. That means you should choose uneven tooth pitch if you anticipate a risk of vibration, i.e. pri-

marily when working at higher overhang or when machining at high radial depth of cut and under conditions which are not entirely stable.

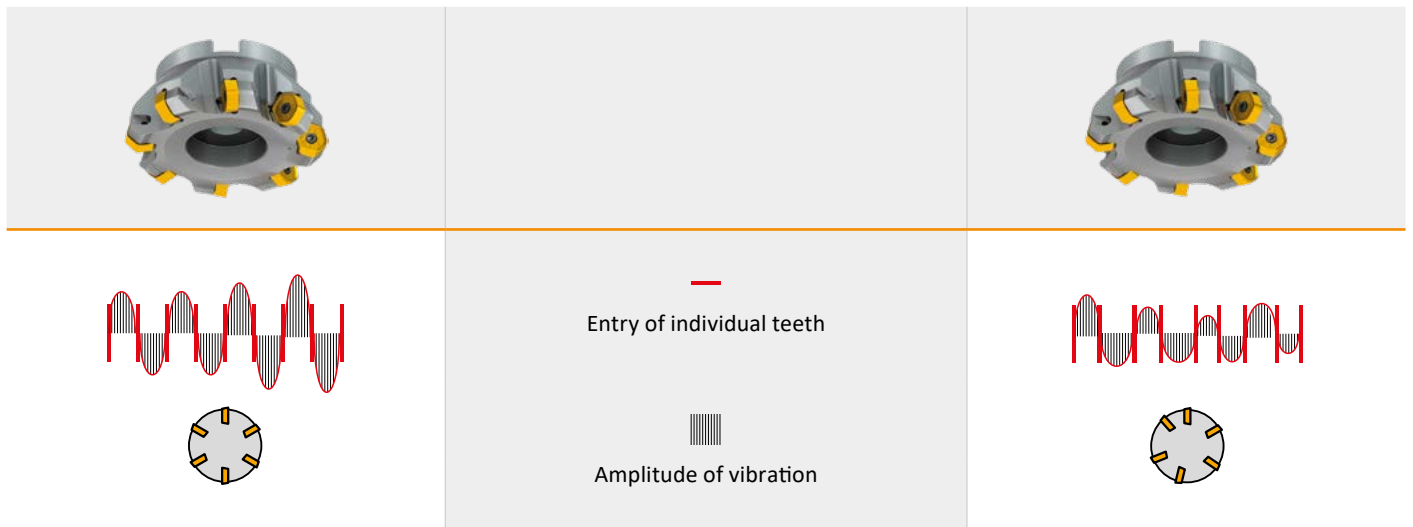

When choosing an indexable insert, please also pay attention to its microgeometry, which is indicated by icons directly in the catalogue section. Below is an overview of the types of cutting edges you can find on our inserts.

Overview of Cutting Edge Designs

<p>F</p>		<p>Sharp cutting edges – recommended for inserts designed for use with milling cutters for Al alloys. Sharp cutting wedges result in minimal deformation of the cut layer, reduced build-up on the edge and a lower cutting force requirement. However, the strength of the cutting wedge is lower compared to other types.</p>
<p>E</p>		<p>Rounded cutting edges – a slight rounding of the wedge with the aim of eliminating micro-imperfections on its surface. Rectifying the wedge at a certain very low radius (RE) improves the cutting edge's resistance to mechanical damage, i.e. brittle fracture or so-called micro-crumbling. This modification is currently used on all indexable inserts without a facet (F modification previously), which are used for milling almost all types of material.</p>
<p>T</p>		<p>Faceted cutting edges – a facet with width of x and angle of γ_x increases the angle γ_n of the cutting wedge in the immediate vicinity of the cutting edge, thus also increasing its strength, i.e. its resistance to mechanical load, brittle damage or fracture. Currently used only rarely, as it has been replaced by the S modification.</p>
<p>S</p>		<p>Rounded edges with facet – compared to the T modification, the insert has undergone rectification which results in rounding of the cutting edge and thickening by a facet. This modification increases the resistance of the wedge against mechanical damage to a greater degree.</p>
<p>K</p>		<p>Edges with double facet – double facet with widths of x_1, x_2 and angle of γ_{x1}, γ_{x2} further increases the strength of the edge, i.e. its resistance to mechanical stress, brittle damage or fracture. Rarely used for milling inserts, only for the most difficult cuts.</p>
<p>P</p>		<p>Rounded edges with double facet – compared to the K modification, the insert has undergone rectification which results in rounding of the cutting edge and thickening by a double facet. This modification provides the wedge with maximum resistance to mechanical damage.</p>



GEOMETRY OF MILLING INSERTS – CONTENT (ALPHABETICAL)

Geometry of milling inserts

The following tables should allow you to choose the insert geometry more precisely with respect to the groups of materials being machined, the nature of the cut, the considered range of depths of cut and the feeds. Cuttings with the main cutting edge are also available (remember that you must also consider the geometry of the cutters when assessing the final geometry).

Milling insert geometries		Milling insert geometries		Milling insert geometries		Milling insert geometries		Milling insert geometries	
A		HNGX 06-R	721	RCMT 12EN-R	734	SEEW 12 SN	747	XDHW EN	759
ADEX 07-FA	709	HNGX 09-F	721	RCMT-F	734	SEMT 09	747	XDHW SN	760
ADEX 07-HF	709	HNGX 09-FF	722	RCMT-M	734	SFCN 12	747	XEHT	760
ADEX 11-FA	709	HNGX 09-M	722	RCMT-R	734	SNET 13-M	748	XNGX ANSN	760
ADEX 11-HF	709	HNGX 09-R	722	RCMT SN-R	735	SNGX 11-M	748	XNGX 13	760
ADEX 11-HF2	710	HNMF 09-R	722	RDET	735	SNGX 11-MM	748	XNHQ TN	761
ADEX 16-FA	710	L		RDEW	735	SNGX 13-M	748	XP ER-FM	761
ADEX 16-FM	710	LC 12-CH	723	RDEX 12	735	SNGX 13-R	749	XPHT 16E	761
ADEX 16-HF	710	LC 12-RE	723	RDEX 16	736	SNHF -M	749	XPHT 16-FA	761
ADEX 16-HF2	711	LC -KP	723	RDGT 07	736	SNHN	749	XPHT 16S	762
ADKT 15-M	711	LC -KPF	723	RDGT 10	736	SNHQ 11	749	Z	
ADKX 15-F	711	LNET 16-M	724	RDGT 12	736	SNHQ 12TN	750	ZDCW 07	762
ADKX 15-F (RAD)	711	LNET 16-R	724	RDGT 12-F	737	SNHQ 12EN	750	ZDCW 09	762
ADMX 07-F	712	LNG(U)X 12-M	724	RDGT 12-FM	737	SNHQ 12TRL	750	ZDEW 12	762
ADMX 07-M	712	LNGU 16-FA	724	RDHT -FA	737	SNK(M)T 12-M	750	ZP ER-F	763
ADMX 11-F	712	LNGU 16-M	725	RDHX 05	737	SNKX	751	ZP ER-FM	763
ADMX 11-M	712	LNGX 12-F	725	RDHX MOT	738	SNMT 12-R	751	ZP ER-M	763
ADMX 11-MF	713	LNGX 12-FA	725	RDMT	738	SNUN	751	ZP ER-R	763
ADMX 11-MM	713	LNGX 12-MF	725	RDMT 12	738	SOMT 05-M	751		
ADMX 11-R	713	LNGX 12-MM	726	RDMT -R	738	SOMT 09-M	752		
ADMX 16-F	713	LNGX 12-R	726	RDMX	739	SOMT 09-MI	752		
ADMX 16-M	714	LNMU 16-F	726	REHT -M	739	SOMT 09-P	752		
ADMX 16-MF	714	LNMU 16-M	726	REHT -MM	739	SPET 12EN	752		
ADMX 16-MM	714	LNMU 16-R	727	RPET 12	739	SPET 12S	753		
ADMX 16-R	714	O		RPET 15-M	740	SPEW 12EN	753		
ANHX 10-F	715	ODEW 06	727	RPEW 12	740	SPEW 12SN	753		
APET 15EN	715	ODKT 05-F	727	RPEW 15	740	SPGN	753		
APET 15SN	715	ODK(M)T 05-FM	727	RPEX -12	740	SPGN DZ	754		
APET 16-FA	715	ODMT 05-R	728	S		SPKN EDSR(L)	754		
APEW 15ER	716	ODMT 06	728	SBKX 22	741	SPKN EDER(L)	754		
APEW 15SR	716	ODMX 06	728	SBMR 22	741	SPKR	754		
APKT 10-FA	716	OEHT 06-FA	728	SBMR 22-R	741	SPKX	755		
APKT 10-M	716	OEHT 06-M	729	SDEW 09EN	741	SPUN	755		
APKT 16-GM	717	OEHT 06-MF	729	SDEW 09SN	742	SPUN 25	755		
APKT 16-HM	717	OEHT 06-MM	729	SDEX 09-74	742	T			
APMT 16 ER-R	717	OEHT 09-M	729	SDGX 12-FM	742	TBMR 27	755		
APMT 16 SR-R	717	OEHT 09-MM	730	SDK(M)T 12-FM (IM)	742	TCMT 16-FM	756		
APMT 16-F	718	OFKR 07-M	730	SDKT 12-F (IM)	743	TNGX 10-F	756		
APMT 16-FM	718	P		SDMT 12-F	743	TNGX 10-FA	756		
B		PDKT 09-FM	730	SDMT 12-F (IM)	743	TNGX 10-M	756		
BNGX 10-HM	718	PDKX 09-FM	730	SDMT 12-M	743	TNGX 16-F	757		
BNGX 10-M	718	PDMW 09	731	SDMT 12-R	744	TNGX 16-FA	757		
BNGX 10-MM	719	PDMX 09-M	731	SDMT 12-R (IM)	744	TNGX 16-M	757		
C		PDMX 09-R	731	SDMX 12-M	744	TNJF 12	757		
CCMX -TS1	719	PNMQ 13	731	SEEN 12FN	744	TPCN 16	758		
CNHQ 10	719	PNMU 13-M	732	SEEN SN	745	TPKN ER	758		
CNHX 05-WM	719	PPH -CL1	732	SEER EN	745	TPKN SR	758		
CNM 563	720	PPH -CL4	732	SEER SN	745	TPKR	758		
H		PPHE -SM1	732	SEET 09	745	TPUN	759		
HNEF 09-F	720	PPHF -CE1	733	SEET 12EN	746	V			
HNEF 09-M	720	PPHT-A2	733	SEET 12SN	746	VC GT 22-FA	759		
HNEF 09-W	720	R		SEET 12-FA	746	W			
HNGX 06-F	721	RC	733	SEET 12-PM	746	WNHX 04-WM	759		
HNGX 06-M	721	RC-F	733	SEEW 12 EN	747				



CHOICE OF CUTTING INSERT

ADEX 07-FA

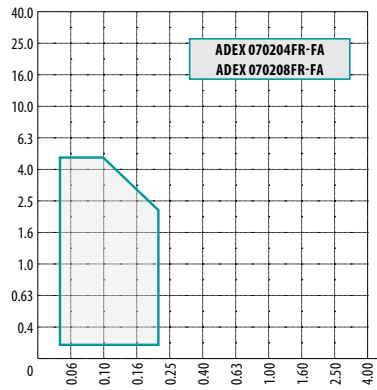
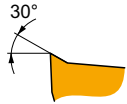

P	M	K	N	S	H
			■		
	0.03 – 0.20				
	0.1 – 5.0				
ADEX 0702..FR-FA					

ADEX 07-HF

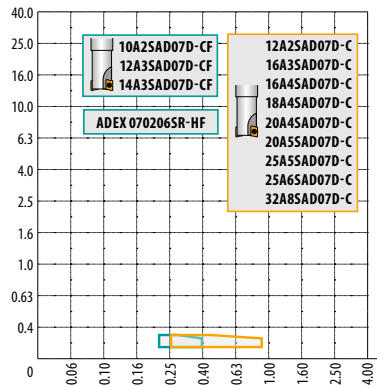
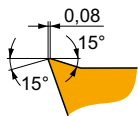

P	M	K	N	S	H
■	■				
	0.20 – 0.90				
	0.1 – 0.3				
ADEX 070206SR-HF					

ADEX 11-FA

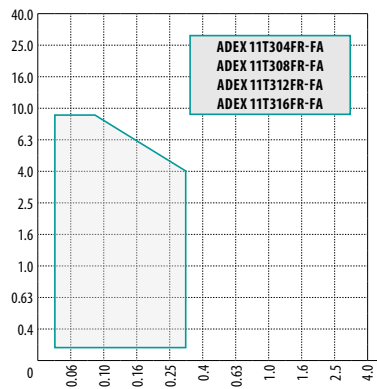
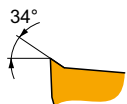





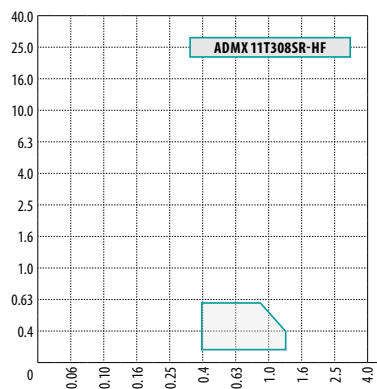
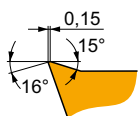





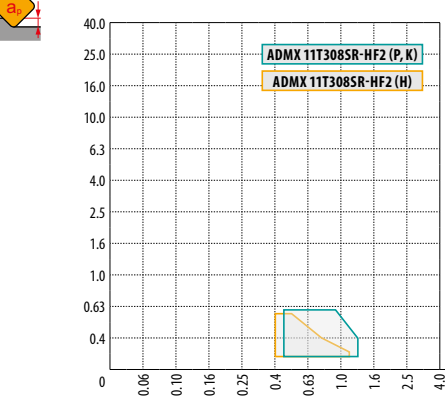







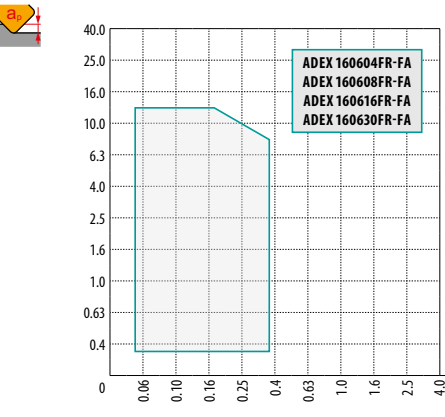







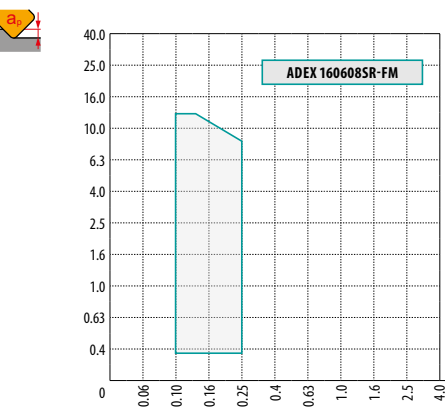



P	M	K	N	S	H
			■		
	0.03 – 0.30				
	0.2 – 9.0				
ADEX 11T304FR-FA, ADEX 11T308FR-FA ADEX 11T312FR-FA, ADEX 11T316FR-FA					

ADEX 11-HF

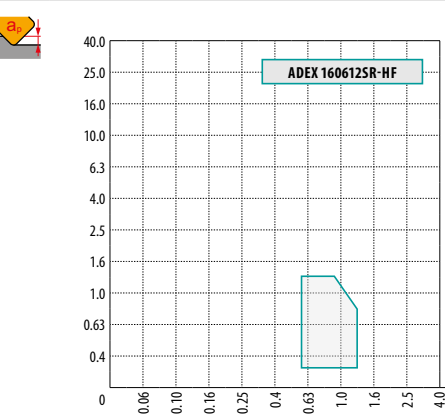

P	M	K	N	S	H
■	■				
	0.40 – 1.3				
	0.1 – 0.6				
ADEX 11T308SR-HF					

CHOICE OF CUTTING INSERT

<p>ADEX 11-HF2</p>			<table border="1"> <thead> <tr> <th>P</th> <th>M</th> <th>K</th> <th>N</th> <th>S</th> <th>H</th> </tr> </thead> <tbody> <tr> <td>■</td> <td>■</td> <td>■</td> <td>■</td> <td>■</td> <td>■</td> </tr> <tr> <td colspan="6"> f 0.40 – 1.3 a_p 0.2 – 0.6 </td> </tr> <tr> <td colspan="6" style="text-align: center;">  </td> </tr> <tr> <td colspan="6" style="text-align: center;">  </td> </tr> <tr> <td colspan="6" style="text-align: center;"> ? ADEX 11T308SR-HF2 </td> </tr> </tbody> </table>	P	M	K	N	S	H	■	■	■	■	■	■	f 0.40 – 1.3 a_p 0.2 – 0.6																		? ADEX 11T308SR-HF2					
P	M	K	N	S	H																																		
■	■	■	■	■	■																																		
f 0.40 – 1.3 a_p 0.2 – 0.6																																							
																																							
																																							
? ADEX 11T308SR-HF2																																							
<p>ADEX 16-FA</p>			<table border="1"> <thead> <tr> <th>P</th> <th>M</th> <th>K</th> <th>N</th> <th>S</th> <th>H</th> </tr> </thead> <tbody> <tr> <td>■</td> <td>■</td> <td>■</td> <td>■</td> <td>■</td> <td>■</td> </tr> <tr> <td colspan="6"> f 0.05 – 0.35 a_p 0.3 – 13.0 </td> </tr> <tr> <td colspan="6" style="text-align: center;">  </td> </tr> <tr> <td colspan="6" style="text-align: center;">  </td> </tr> <tr> <td colspan="6" style="text-align: center;"> ? ADEX 160604FR-FA, ADEX 160608FR-FA ADEX 160616FR-FA, ADEX 160630FR-FA </td> </tr> </tbody> </table>	P	M	K	N	S	H	■	■	■	■	■	■	f 0.05 – 0.35 a_p 0.3 – 13.0																		? ADEX 160604FR-FA, ADEX 160608FR-FA ADEX 160616FR-FA, ADEX 160630FR-FA					
P	M	K	N	S	H																																		
■	■	■	■	■	■																																		
f 0.05 – 0.35 a_p 0.3 – 13.0																																							
																																							
																																							
? ADEX 160604FR-FA, ADEX 160608FR-FA ADEX 160616FR-FA, ADEX 160630FR-FA																																							
<p>ADEX 16-FM</p>			<table border="1"> <thead> <tr> <th>P</th> <th>M</th> <th>K</th> <th>N</th> <th>S</th> <th>H</th> </tr> </thead> <tbody> <tr> <td>■</td> <td>■</td> <td>■</td> <td>■</td> <td>■</td> <td>■</td> </tr> <tr> <td colspan="6"> f 0.10 – 0.25 a_p 0.3 – 13.0 </td> </tr> <tr> <td colspan="6" style="text-align: center;">  </td> </tr> <tr> <td colspan="6" style="text-align: center;">  </td> </tr> <tr> <td colspan="6" style="text-align: center;"> ? ADEX 160608SR-FM </td> </tr> </tbody> </table>	P	M	K	N	S	H	■	■	■	■	■	■	f 0.10 – 0.25 a_p 0.3 – 13.0																		? ADEX 160608SR-FM					
P	M	K	N	S	H																																		
■	■	■	■	■	■																																		
f 0.10 – 0.25 a_p 0.3 – 13.0																																							
																																							
																																							
? ADEX 160608SR-FM																																							
<p>ADEX 16-HF</p>			<table border="1"> <thead> <tr> <th>P</th> <th>M</th> <th>K</th> <th>N</th> <th>S</th> <th>H</th> </tr> </thead> <tbody> <tr> <td>■</td> <td>■</td> <td>■</td> <td>■</td> <td>■</td> <td>■</td> </tr> <tr> <td colspan="6"> f 0.60 – 1.3 a_p 0.3 – 1.3 </td> </tr> <tr> <td colspan="6" style="text-align: center;">  </td> </tr> <tr> <td colspan="6" style="text-align: center;">  </td> </tr> <tr> <td colspan="6" style="text-align: center;"> ? ADEX 160612SR-HF </td> </tr> </tbody> </table>	P	M	K	N	S	H	■	■	■	■	■	■	f 0.60 – 1.3 a_p 0.3 – 1.3																		? ADEX 160612SR-HF					
P	M	K	N	S	H																																		
■	■	■	■	■	■																																		
f 0.60 – 1.3 a_p 0.3 – 1.3																																							
																																							
																																							
? ADEX 160612SR-HF																																							



CHOICE OF CUTTING INSERT

ADEX 16-HF2



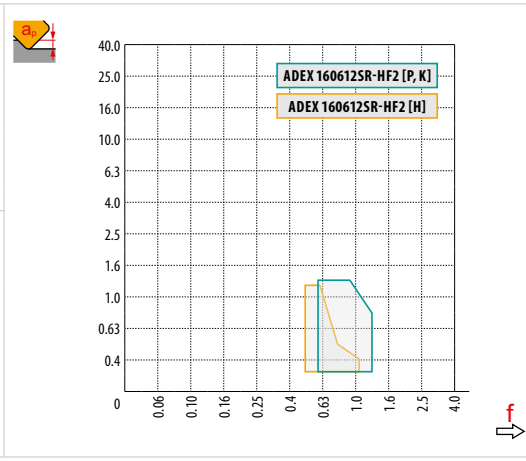

P	M	K	N	S	H
■	■	■	■	■	■
f → 0.60 – 1.3					
a _p ↓ 0.3 – 1.3					



? ADEX 160612SR-HF2

ADKT 15-M

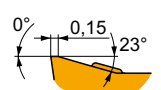
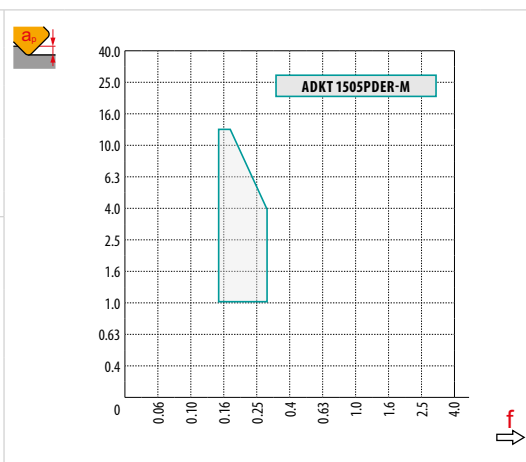
P	M	K	N	S	H
■	■	■	■	■	■
f → 0.15 – 0.30					
a _p ↓ 1.0 – 13.0					



? ADKT 1505PDER-M

ADKX 15-F



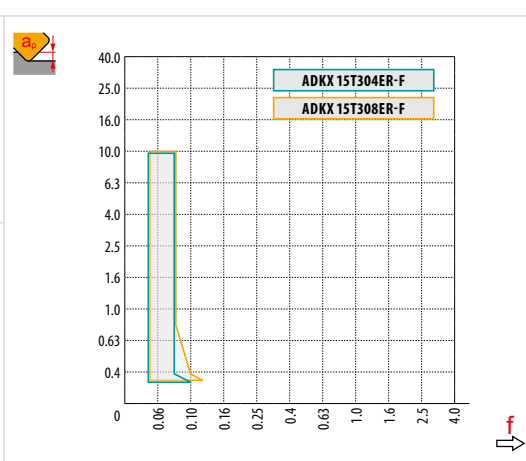

P	M	K	N	S	H
■	■	■	■	■	■
f → 0.05 – 0.12					
a _p ↓ 0.3 – 10.0					



**? ADKX 15T304ER-F
ADKX 15T308ER-F**

ADKX 15-F (RAD)



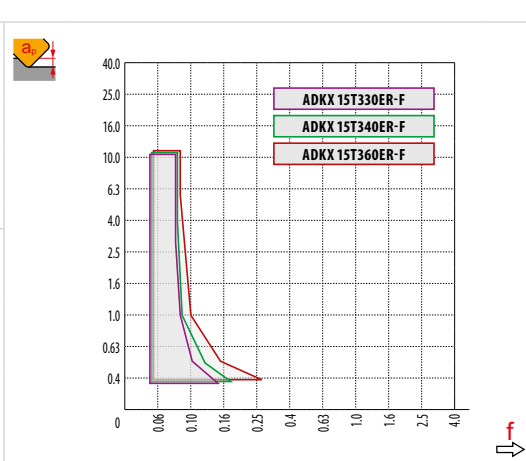

P	M	K	N	S	H
■	■	■	■	■	■
f → 0.05 – 0.26 (according to insert radii)					
a _p ↓ 0.3 – 10.0					



**? ADKX 15T330ER-F
ADKX 15T340ER-F
ADKX 15T360ER-F**



CHOICE OF CUTTING INSERT

ADMX 07-F

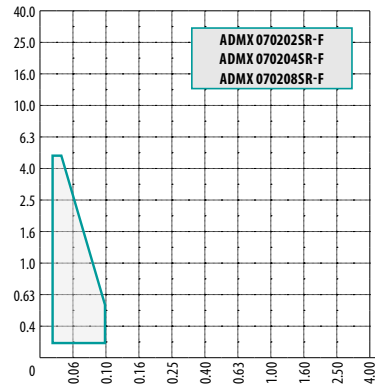
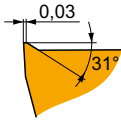

P	M	K	N	S	H
■	■	■	▣	▣	
f	0.02 – 0.10				
a_p	0.1 – 5.0				
?	ADMX 070202SR-F ADMX 070204SR-F ADMX 070208SR-F				

ADMX 07-M

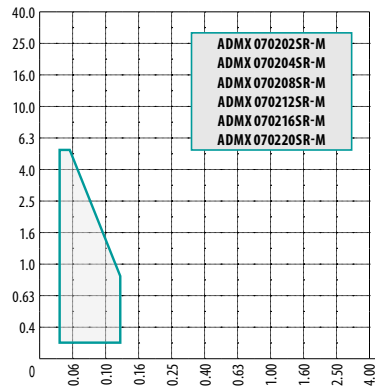
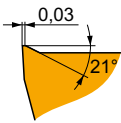

P	M	K	N	S	H
■	▣	▣	▣	▣	
f	0.03 – 0.12				
a_p	0.1 – 5.0				
?	ADMX 070202SR-M, ADMX 070204SR-M ADMX 070208SR-M, ADMX 070212SR-M ADMX 070216SR-M, ADMX 070220SR-M				

ADMX 11-F

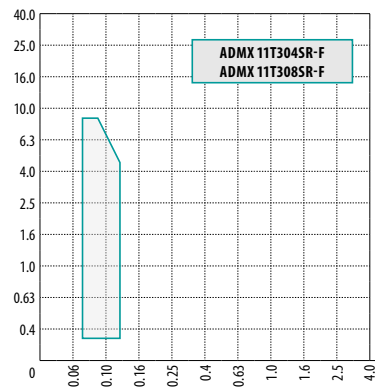
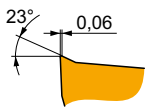

P	M	K	N	S	H
■	▣	▣	▣	▣	
f	0.07 – 0.12				
a_p	0.2 – 9.0				
?	ADMX 11T304SR-F ADMX 11T308SR-F				

ADMX 11-M

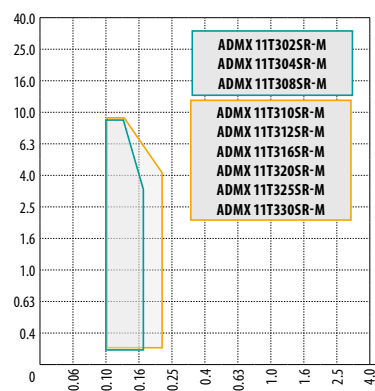
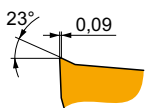





P	M	K	N	S	H
■	■	■	▣	▣	
f	0.10 – 0.22				
a_p	0.2 – 9.0				
?	ADMX 11T3..SR-M				

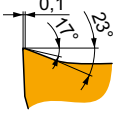
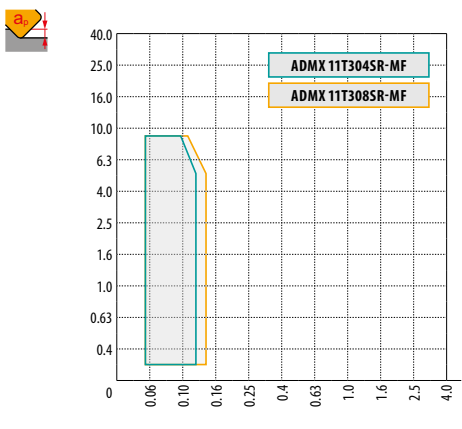

CHOICE OF CUTTING INSERT



ADMX 11-MF

P	M	K	N	S	H
■	■	■	▣	■	■
f	0.05 – 0.14				
a_p	0.2 – 9.0				
					
					
 ADMX 11T304SR-MF ADMX 11T308SR-MF					

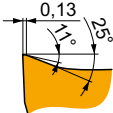
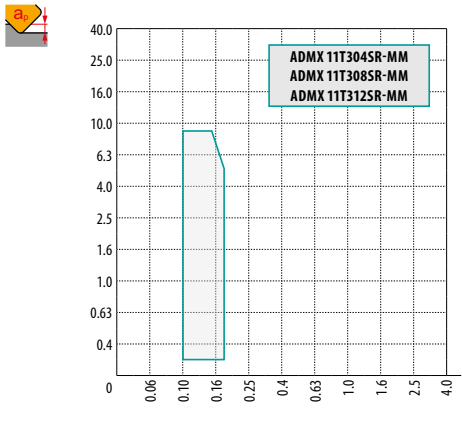

ADMX 11-MM

P	M	K	N	S	H
■	■	■	▣	■	■
f	0.10 – 0.18				
a_p	0.2 – 9.0				
					
					
 ADMX 11T304SR-MM ADMX 11T308SR-MM ADMX 11T312SR-MM					

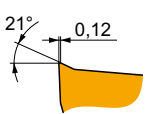
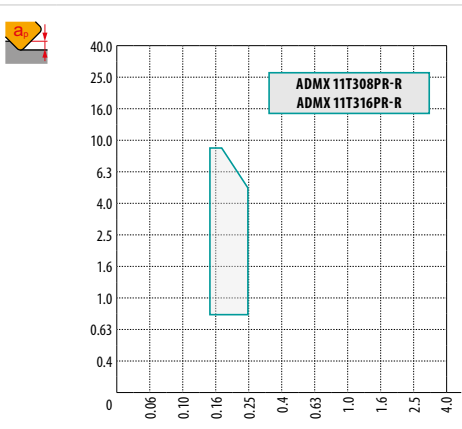

ADMX 11-R

P	M	K	N	S	H
■	▣	■	■	▣	▣
f	0.15 – 0.25				
a_p	0.8 – 9.0				
					
					
 ADMX 11T3..PR-R					

ADMX 16-F

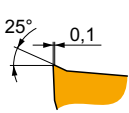
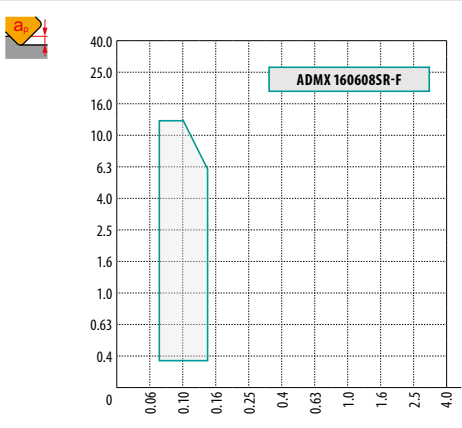



P	M	K	N	S	H
■	▣	▣	▣	▣	■
f	0.07 – 0.15				
a_p	0.3 – 13.0				
					
					
 ADMX 160608SR-F					

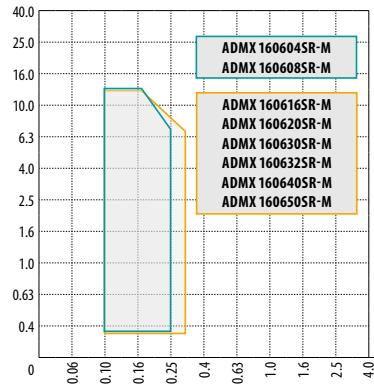

CHOICE OF CUTTING INSERT

ADMX 16-M



P	M	K	N	S	H
■	■	■	□	□	□
f	0.10 – 0.25				
a_p	0.3 – 13.0				
ADMX 1606..SR-M					

ADMX 16-MF

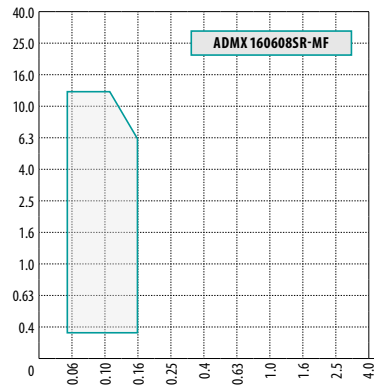
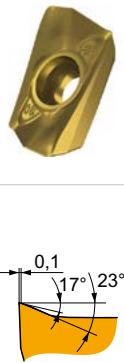

P	M	K	N	S	H
■	■	■	□	■	□
f	0.05 – 0.16				
a_p	0.3 – 13.0				
ADMX 160608SR-MF					

ADMX 16-MM

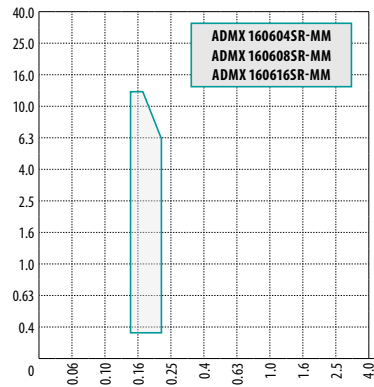

P	M	K	N	S	H
■	■	■	□	■	□
f	0.14 – 0.22				
a_p	0.3 – 13.0				
ADMX 160604SR-MM ADMX 160608SR-MM ADMX 160616SR-MM					

ADMX 16-R

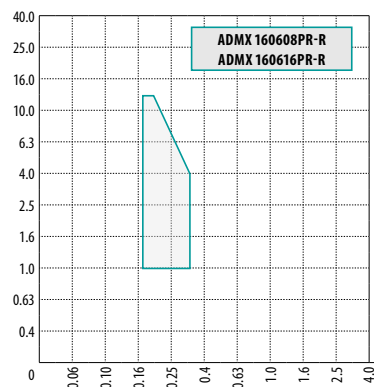

P	M	K	N	S	H
■	□	■	□	□	□
f	0.17 – 0.35				
a_p	1.0 – 13.0				
ADMX 160608PR-R ADMX 160616PR-R					

CHOICE OF CUTTING INSERT

ANHX 10-F

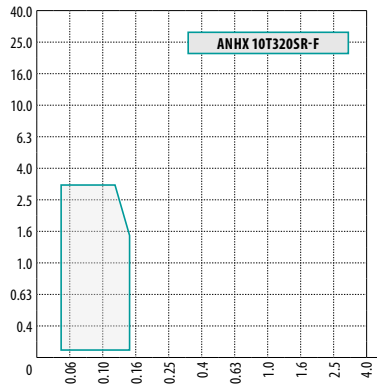
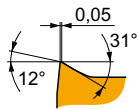

P	M	K	N	S	H
■	▣	■	■	■	■
0.05 – 0.15					
0.1 – 3.0					
ANHX 10T320SR-F					

APET 15EN

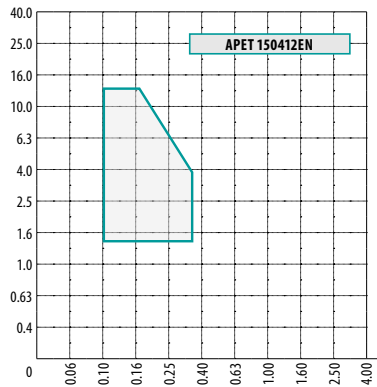
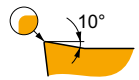

P	M	K	N	S	H
■	▣	■	■	▣	■
0.10 – 0.35					
1.5 – 12.0					
APET 150412EN					

APET 15SN

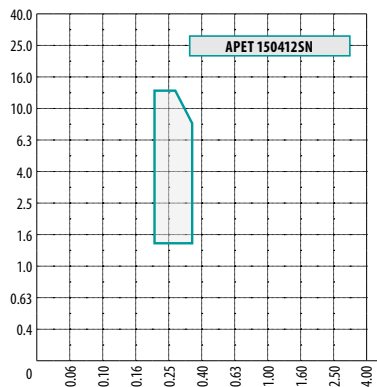
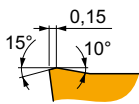

P	M	K	N	S	H
■	▣	■	■	▣	■
0.20 – 0.35					
1.5 – 12.0					
APET 150412SN					

APET 16-FA

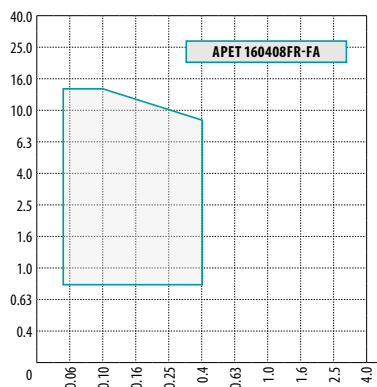
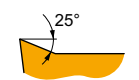

P	M	K	N	S	H
■	▣	■	■	■	■
0.05 – 0.40					
0.8 – 15.0					
APET 160408FR-FA					

CHOICE OF CUTTING INSERT

APEW 15ER

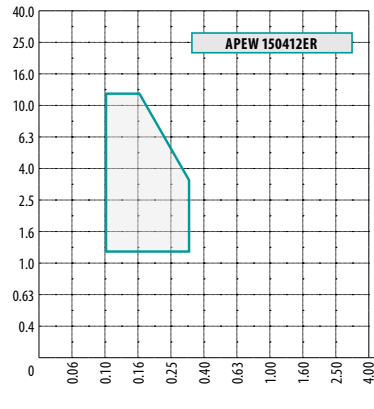

P	M	K	N	S	H
<input checked="" type="checkbox"/>	<input type="checkbox"/>	<input checked="" type="checkbox"/>	<input type="checkbox"/>	<input type="checkbox"/>	<input checked="" type="checkbox"/>
f 0.10 – 0.30					
a_p 1.2 – 12.0					
APEW 150412ER					

APEW 15SR

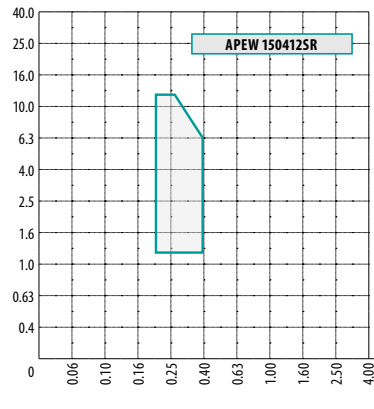
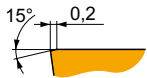

P	M	K	N	S	H
<input checked="" type="checkbox"/>	<input type="checkbox"/>	<input checked="" type="checkbox"/>	<input type="checkbox"/>	<input type="checkbox"/>	<input checked="" type="checkbox"/>
f 0.20 – 0.40					
a_p 1.2 – 12.0					
APEW 150412SR					

APKT 10-FA

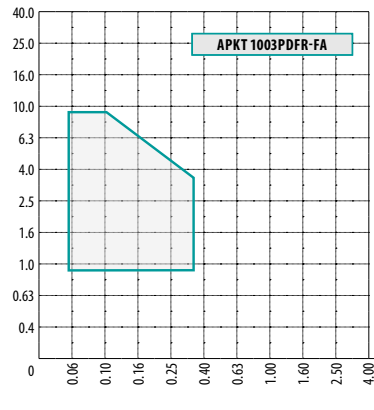
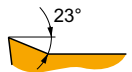

P	M	K	N	S	H
<input type="checkbox"/>	<input type="checkbox"/>	<input checked="" type="checkbox"/>	<input type="checkbox"/>	<input type="checkbox"/>	<input type="checkbox"/>
f 0.05 – 0.30					
a_p 0.8 – 9.0					
APKT 1003PDR-FA					

APKT 10-M

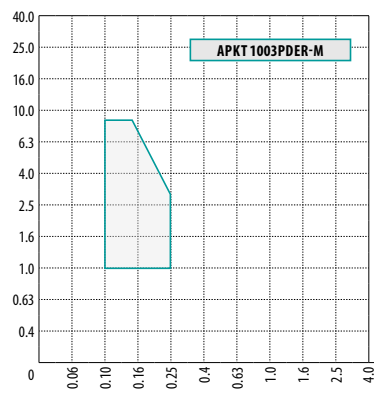
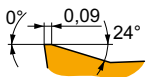

P	M	K	N	S	H
<input checked="" type="checkbox"/>	<input checked="" type="checkbox"/>	<input checked="" type="checkbox"/>	<input type="checkbox"/>	<input checked="" type="checkbox"/>	<input type="checkbox"/>
f 0.10 – 0.25					
a_p 1.0 – 9.0					
APKT 1003PDR-M					



CHOICE OF CUTTING INSERT

APKT 16-GM

P	M	K	N	S	H
■	▣	■	■	▣	■
f		0.15 – 0.30			
a _p		1.0 – 13.0			

? APKT 1604PDR-GM

APKT 16-HM

P	M	K	N	S	H
■	▣	■	■	▣	■
f		0.20 – 0.35			
a _p		1.0 – 13.0			

**? APKT 1604PDR-HM, APKT 160404-HM
APKT 160416-HM, APKT 160431-HM**

APMT 16 ER-R

P	M	K	N	S	H
■	■	■	■	■	■
f		0.15 – 0.30			
a _p		0.8 – 13.0			

? APMT 1604PDR-R

APMT 16 SR-R

P	M	K	N	S	H
■	■	■	■	■	■
f		0.17 – 0.40			
a _p		0.8 – 13.0			

? APMT 1604PDSR-R

CHOICE OF CUTTING INSERT

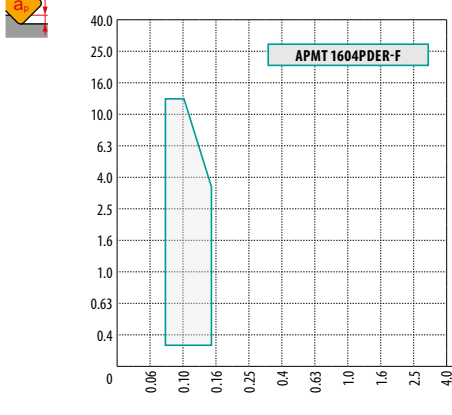

APMT 16-F

P	M	K	N	S	H
■	■	▣	■	▣	■

f 0.07 – 0.15

a_p 0.3 – 13.0

? APMT 1604PDER-F

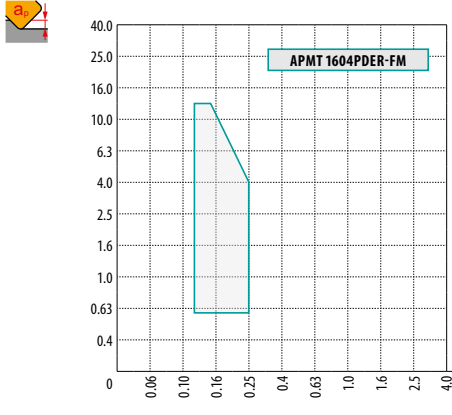

APMT 16-FM

P	M	K	N	S	H
■	■	▣	■	▣	■

f 0.12 – 0.25

a_p 0.6 – 13.0

? APMT 1604PDER-FM

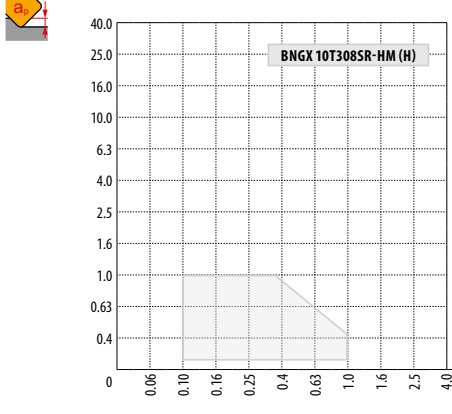

BNGX 10-HM

P	M	K	N	S	H
■	■	▣	■	▣	■

f 0.10 – 1.00

a_p 0.1 – 1.0

? BNGX 10T308SR-HM

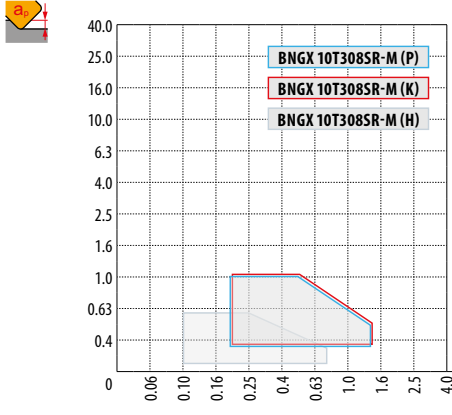

BNGX 10-M

P	M	K	N	S	H
■	■	■	■	▣	▣

f 0.20 – 1.40

a_p 0.3 – 1.0

? BNGX 10T308SR-M

CHOICE OF CUTTING INSERT

BNGX 10-MM

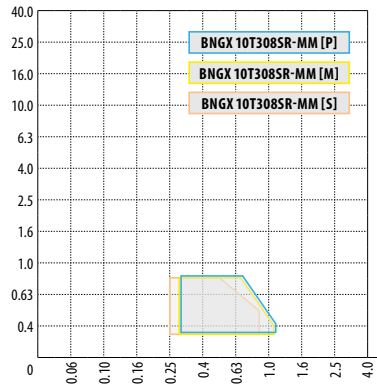
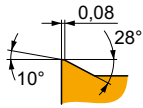

P	M	K	N	S	H
■	■	■	■	■	■
0.20 – 1.10					
0.3 – 1.0					
BNGX 10T3085R-MM					

CCMX -TS1

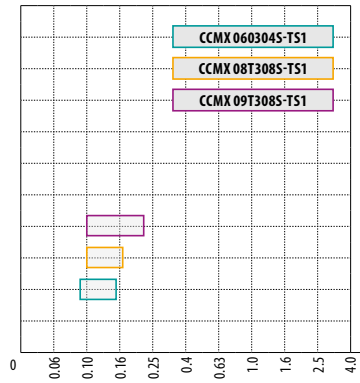
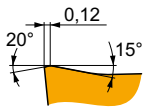

P	M	K	N	S	H
■	■	■	■	■	■
0.08 – 0.18 (according to insert size)					
-					
CCMX 0603045-TS1 CCMX 08T3085-TS1 CCMX 09T3085-TS1					

CNHQ 10

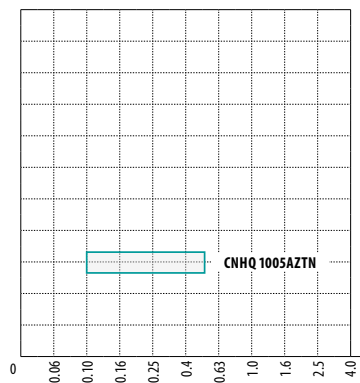
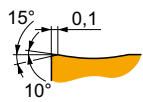
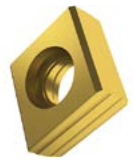

P	M	K	N	S	H
■	■	■	■	■	■
0.10 – 0.50					
-					
CNHQ 1005AZTN					

CNHX 05-WM

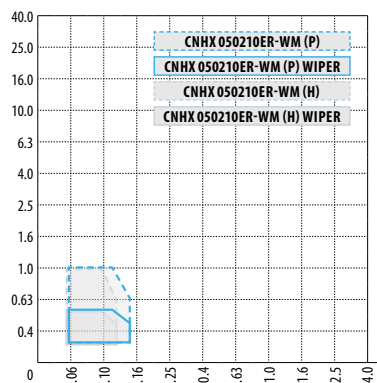
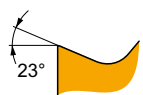





P	M	K	N	S	H
■	■	■	■	■	■
0.05 – 0.15					
0.1 – 1.0					
CNHX 050210ER-WM CNHX 050210ER-WM					

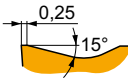
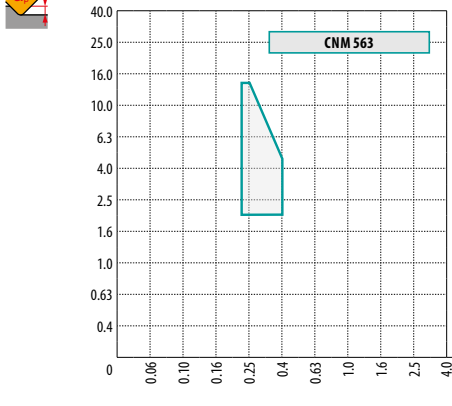

CHOICE OF CUTTING INSERT



CNM 563

P	M	K	N	S	H
■		■			
f 0.20 – 0.40					
a _p 2.0 – 14.0					
					
					
 CNM 563					

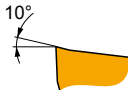
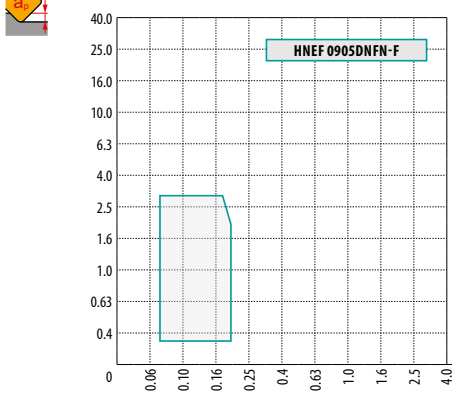

HNEF 09-F



P	M	K	N	S	H
		■			
f 0.07 – 0.20					
a _p 0.3 – 3.0					
					
					
 HNEF 0905DNFN-F					

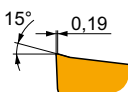
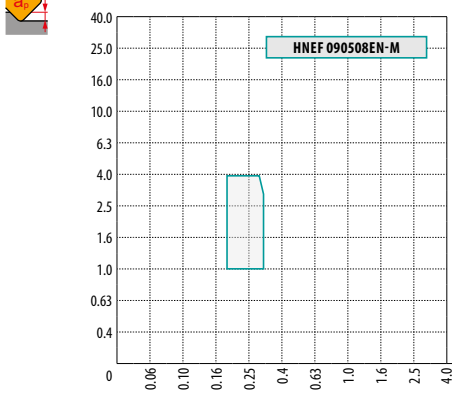

HNEF 09-M

P	M	K	N	S	H
		■			
f 0.17 – 0.30					
a _p 1.0 – 4.0					
					
					
 HNEF 090508EN-M					

HNEF 09-W

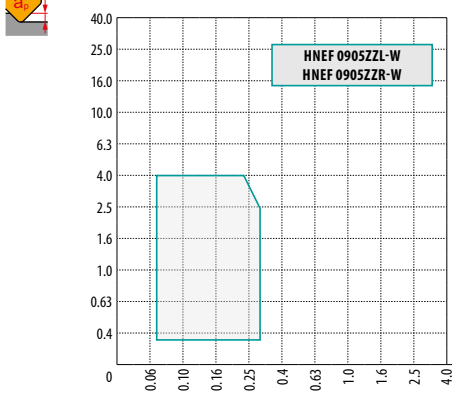
P	M	K	N	S	H
		■			
f 0.07 – 0.30					
a _p 0.3 – 4.0					
					
					
 HNEF 0905ZZL-W HNEF 0905ZZR-W					

CHOICE OF CUTTING INSERT

HNGX 06-F

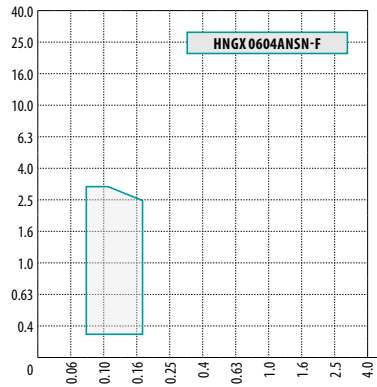
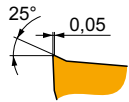

P	M	K	N	S	H
■	■	■	■	■	■
f 0.08 – 0.17					
a_p 0.3 – 3.0					
HNGX 0604ANSN-F					

HNGX 06-M

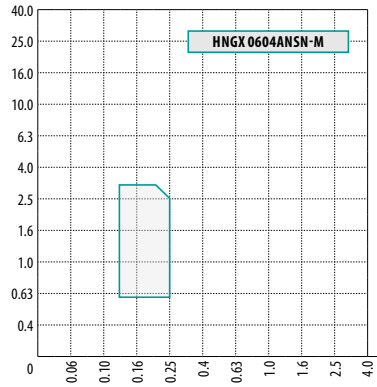
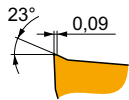

P	M	K	N	S	H
■	■	■	■	■	■
f 0.13 – 0.25					
a_p 0.6 – 3.0					
HNGX 0604ANSN-M					

HNGX 06-R

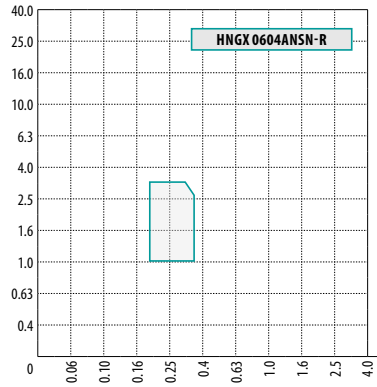
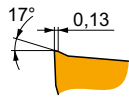

P	M	K	N	S	H
■	■	■	■	■	■
f 0.18 – 0.30					
a_p 1.0 – 3.0					
HNGX 0604ANSN-R					

HNGX 09-F

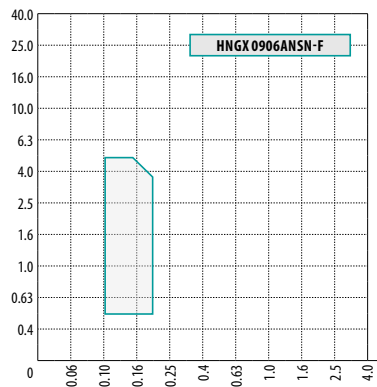
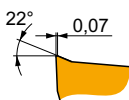



P	M	K	N	S	H
■	■	■	■	■	■
f 0.10 – 0.20					
a_p 0.5 – 5.0					
HNGX 0906ANSN-F					

CHOICE OF CUTTING INSERT

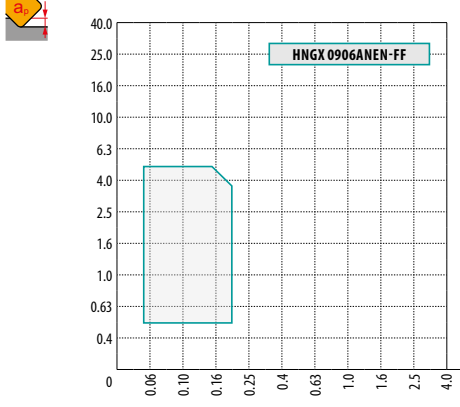

HNGX 09-FF

P	M	K	N	S	H
■	■	■	■	■	■
f 0.05 – 0.20					
a _p 0.5 – 5.0					
					
					
 HNGX 0906ANEN-FF					

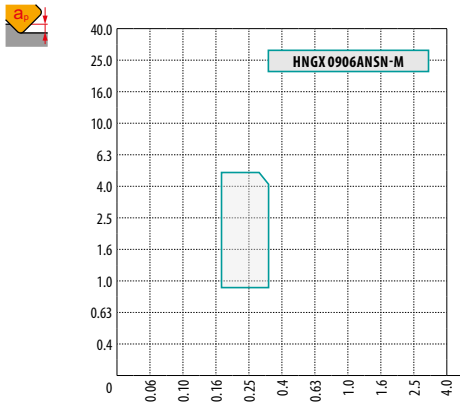

HNGX 09-M

P	M	K	N	S	H
■	▣	■	■	■	■
f 0.17 – 0.35					
a _p 0.8 – 5.0					
					
					
 HNGX 0906ANSN-M					

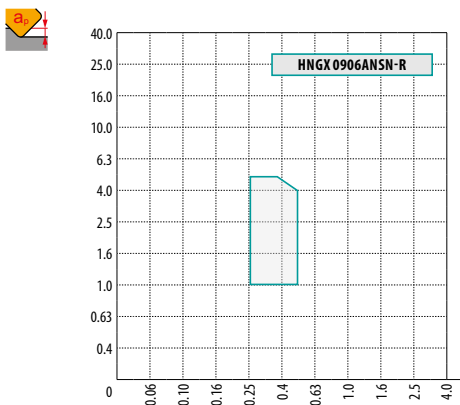

HNGX 09-R

P	M	K	N	S	H
■	▣	■	■	■	▣
f 0.25 – 0.50					
a _p 1.0 – 5.0					
					
					
 HNGX 0906ANSN-R					

HNMF 09-R

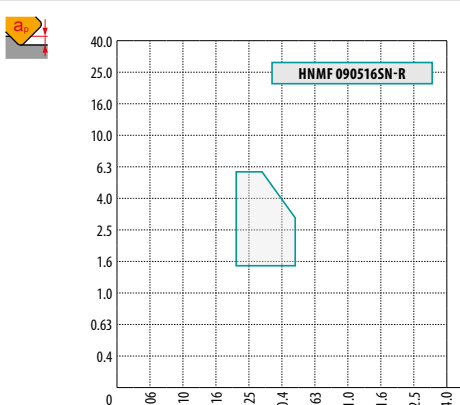



P	M	K	N	S	H
■	■	■	■	■	■
f 0.22 – 0.50					
a _p 1.5 – 6.0					
					
					
 HNMF 090516SN-R					

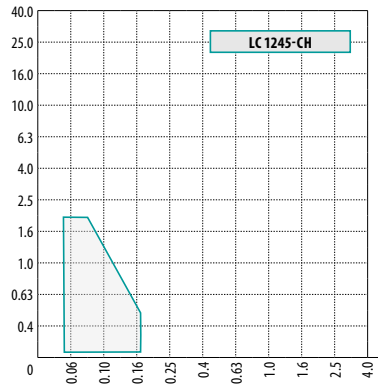

CHOICE OF CUTTING INSERT

LC 12-CH



P	M	K	N	S	H
█	█	█	█	█	█
f	0.08 – 0.25				
a_p	0.1 – 2.0				

? LC 1245-CH

LC 12-RE

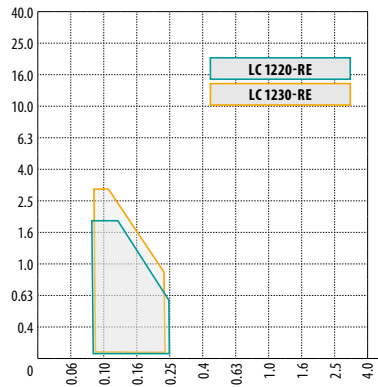

P	M	K	N	S	H
█	█	█	█	█	█
f	0.08 – 0.25				
a_p	0.1 – 3.0 (according to insert size)				

? LC 1220-RE
LC 1230-RE

LC -KP

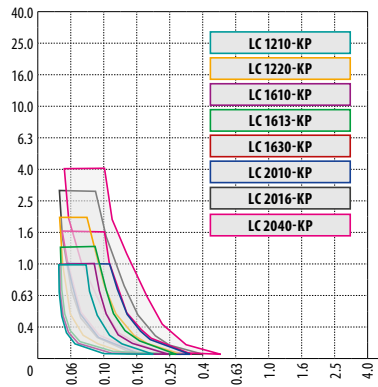

P	M	K	N	S	H
█	█	█	█	█	█
f	0.08 – 0.35 (according to insert size)				
a_p	0.1 – 4.0 (according to insert size)				

? LC-KP

LC -KPF

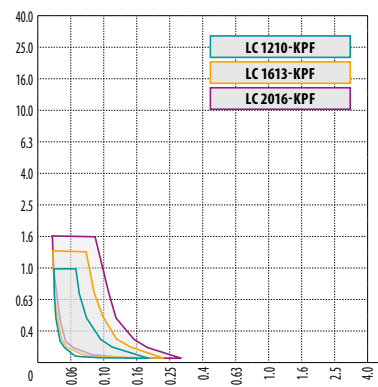

P	M	K	N	S	H
█	█	█	█	█	█
f	0.05 – 0.30 (according to insert size and radii)				
a_p	0.1 – 1.6 (according to insert size and radii)				

? LC 1210-KPF
LC 1613-KPF
LC 2016-KPF



CHOICE OF CUTTING INSERT

LNET 16-M

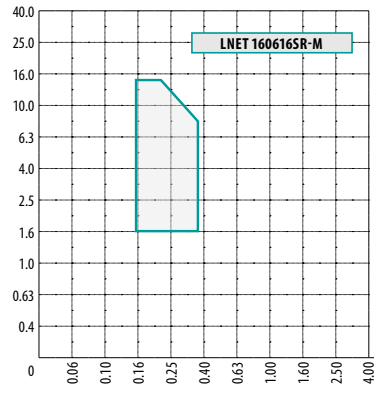
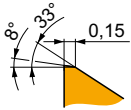

P	M	K	N	S	H
■	■	■	■	■	■

f 0.15 – 0.35

a_p 1.6 – 15.0

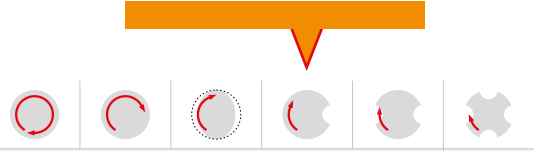

? LNET 160616SR-M

LNET 16-R

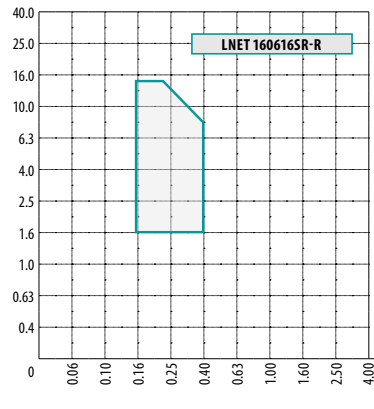
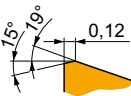

P	M	K	N	S	H
■	■	■	■	■	■

f 0.15 – 0.40

a_p 1.6 – 15.0

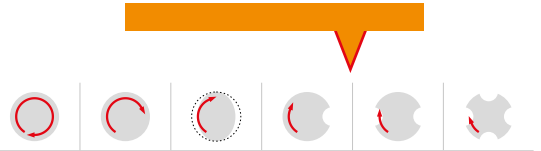

? LNET 160616SR-R

LNG(U)X 12-M

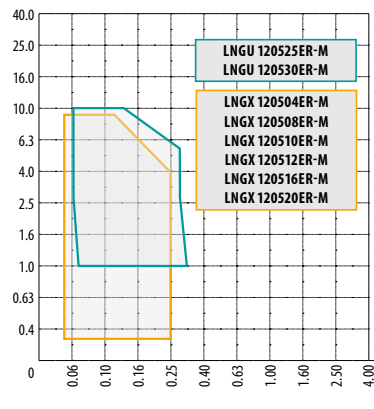
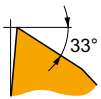

P	M	K	N	S	H
■	■	■	■	■	■

f 0.05 – 0.25

a_p 0.2 – 9.0 (according to insert radii)

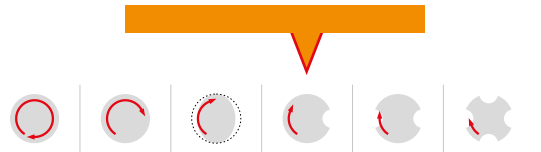

? LNGU 1205..ER-M
LNGX 1205..ER-M

LNGU 16-FA

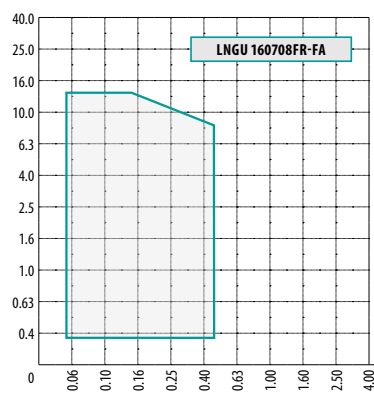
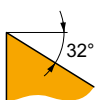

P	M	K	N	S	H
■	■	■	■	■	■

f 0.05 – 0.45

a_p 0.3 – 13.0

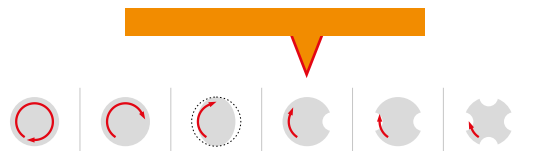

? LNGU 160708FR-FA



CHOICE OF CUTTING INSERT

LNGU 16-M

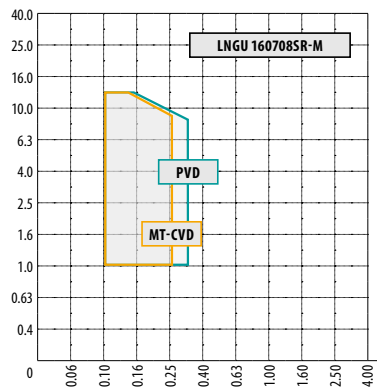
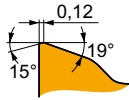
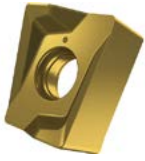

P	M	K	N	S	H
■	■	■	■	■	■
f 0.10 – 0.30 (according to insert coating)					
a_p 1.0 – 13.0					
LNGU 160708SR-M					

LNGX 12-F

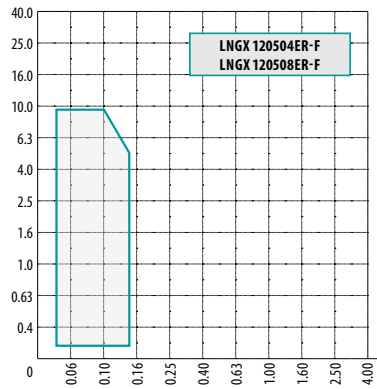
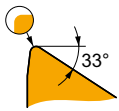
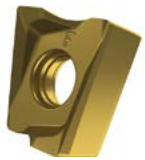

P	M	K	N	S	H
■	■	■	■	■	■
f 0.04 – 0.15					
a_p 0.2 – 9.0					
LNGX 120504ER-F LNGX 120508ER-F					

LNGX 12-FA

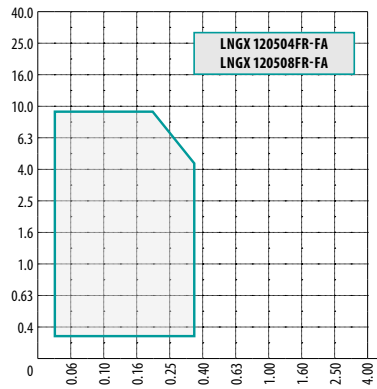
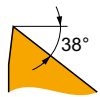

P	M	K	N	S	H
■	■	■	■	■	■
f 0.03 – 0.35					
a_p 0.2 – 9.0					
LNGX 120504FR-FA LNGX 120508FR-FA					

LNGX 12-MF

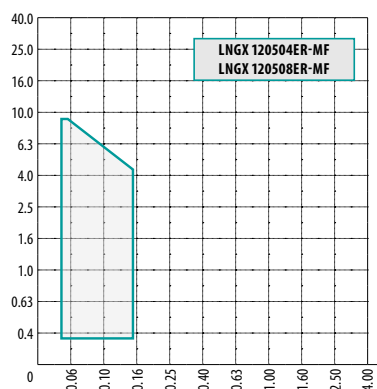
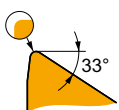

P	M	K	N	S	H
■	■	■	■	■	■
f 0.04 – 0.15					
a_p 0.3 – 9.0					
LNGX 120504ER-MF LNGX 120508ER-MF					



CHOICE OF CUTTING INSERT

LNGX 12-MM

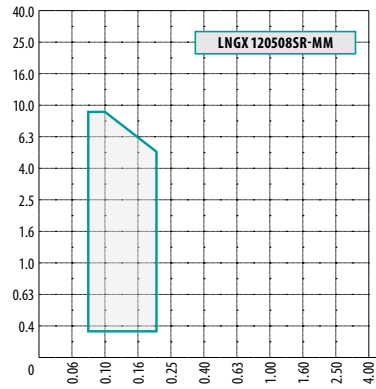
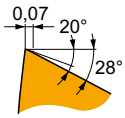

P	M	K	N	S	H
■	■	■	■	■	■
f 0.08 – 0.20					
a _p 0.3 – 9.0					

? LNGX 120508SR-MM

LNGX 12-R

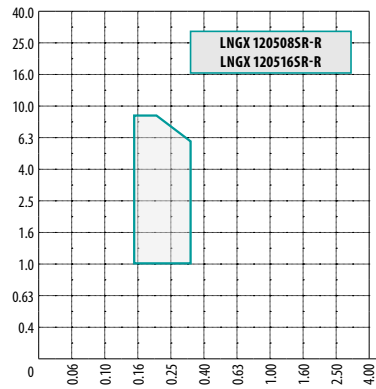
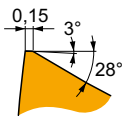

P	M	K	N	S	H
■	■	■	■	■	■
f 0.15 – 0.35					
a _p 1.0 – 9.0					

? LNGX 120508SR-R
LNGX 120516SR-R

LNMU 16-F

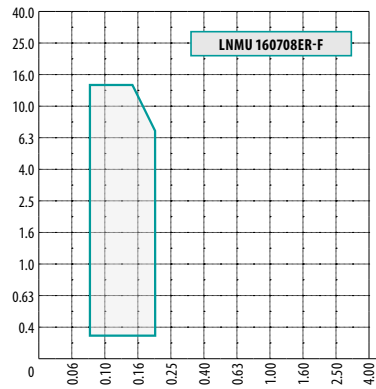

P	M	K	N	S	H
■	■	■	■	■	■
f 0.08 – 0.20					
a _p 0.3 – 13.0					

? LNMU 160708ER-F

LNMU 16-M

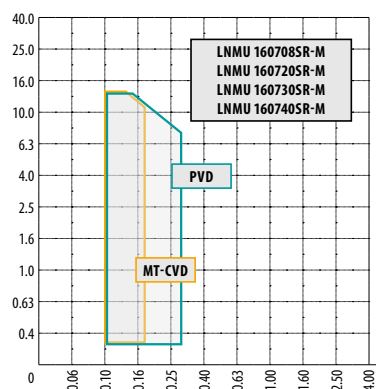
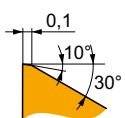

P	M	K	N	S	H
■	■	■	■	■	■
f 0.10 – 0.30 (according to insert coating)					
a _p 0.3 – 13.0					

? LNMU 160708SR-M, LNMU 160720SR-M
LNMU 160730SR-M, LNMU 160740SR-M



CHOICE OF CUTTING INSERT

LNMU 16-R

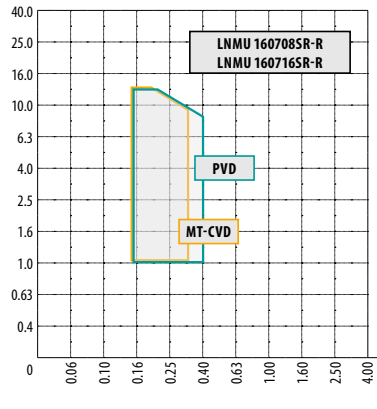
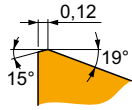

P	M	K	N	S	H
■	■	■	■	■	■
f 0.15 – 0.40 (according to insert coating)					
a_p 1.0 – 13.0					
? LNMU 160708SR-R LNMU 160716SR-R					

ODEW 06

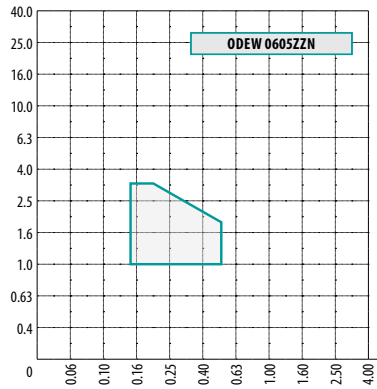
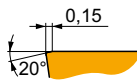
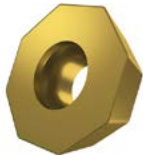

P	M	K	N	S	H
■	■	■	■	■	■
f 0.15 – 0.45					
a_p 1.0 – 3.1					
? ODEW 0605ZZN					

ODKT 05-F

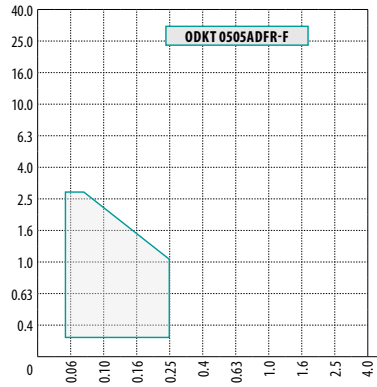
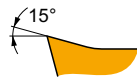

P	M	K	N	S	H
■	■	■	■	■	■
f 0.05 – 0.25					
a_p 0.2 – 2.7					
? ODKT 0505ADFR-F					

ODK(M)T 05-FM

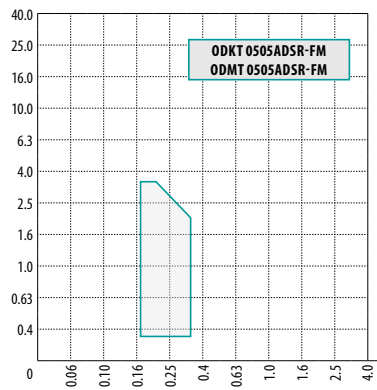
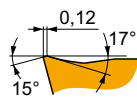

P	M	K	N	S	H
■	■	■	■	■	■
f 0.17 – 0.35					
a_p 0.3 – 3.0					
? ODKT 0505ADSR-FM ODMT 0505ADSR-FM					



CHOICE OF CUTTING INSERT

ODMT 05-R

P	M	K	N	S	H
■		■			
f 0.23 – 0.45					
a_p 0.3 – 3.0					
? ODMT 050508SN-R					

ODMT 06

P	M	K	N	S	H
■		■			
f 0.15 – 0.45					
a_p 1.0 – 3.1					
? ODMT 0605ZZN					

ODMX 06

P	M	K	N	S	H
■		■			■
f 0.15 – 0.45					
a_p 1.0 – 3.1					
? ODMX 0605ZZ					

OEHT 06-FA

P	M	K	N	S	H
			■		
f 0.08 – 0.20					
a_p 0.5 – 3.3					
? OEHT 0604AEFR-FA					



CHOICE OF CUTTING INSERT

OEHT 06-M

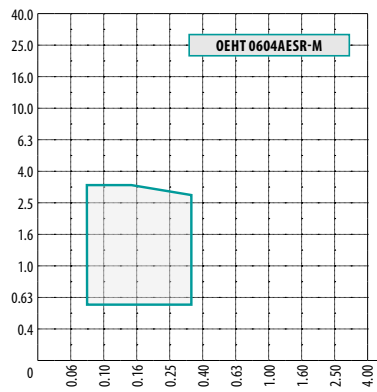
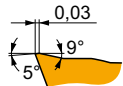

P	M	K	N	S	H
■	■	■	■	■	■
f		0.08 – 0.35			
a_p		0.5 – 3.3			
? OEHT 0604AESR-M					

OEHT 06-MF

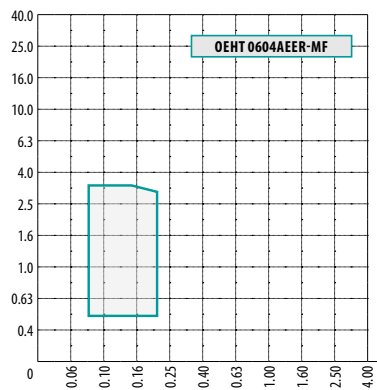
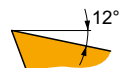

P	M	K	N	S	H
■	■	■	■	■	■
f		0.08 – 0.20			
a_p		0.5 – 3.3			
? OEHT 0604AEEF-MF					

OEHT 06-MM

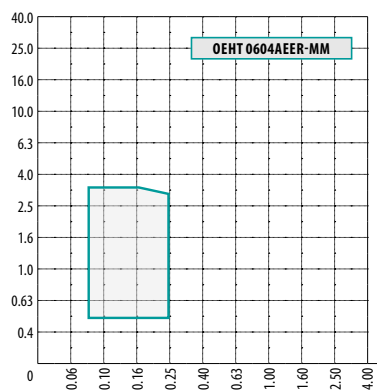
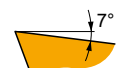

P	M	K	N	S	H
■	■	■	■	■	■
f		0.08 – 0.25			
a_p		0.5 – 3.3			
? OEHT 0604AEEF-MM					

OEHT 09-M

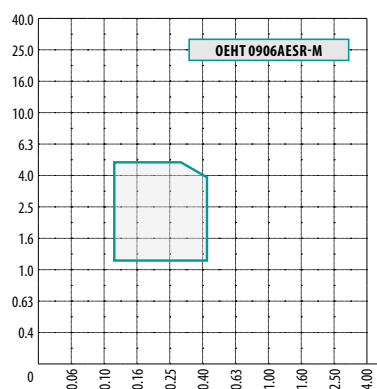
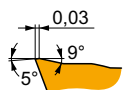

P	M	K	N	S	H
■	■	■	■	■	■
f		0.12 – 0.45			
a_p		1.2 – 5.0			
? OEHT 0906AESR-M					



CHOICE OF CUTTING INSERT

OEHT 09-MM

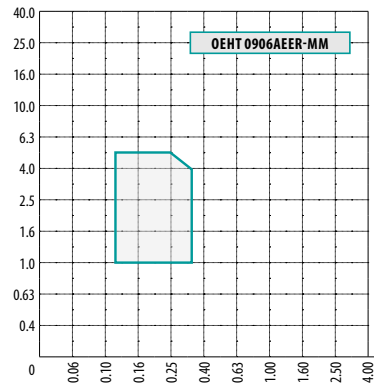
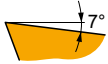

P	M	K	N	S	H
<input checked="" type="checkbox"/>	<input checked="" type="checkbox"/>	<input checked="" type="checkbox"/>	<input checked="" type="checkbox"/>	<input checked="" type="checkbox"/>	<input checked="" type="checkbox"/>
f 0.12 – 0.35					
a _p 1.0 – 5.0					

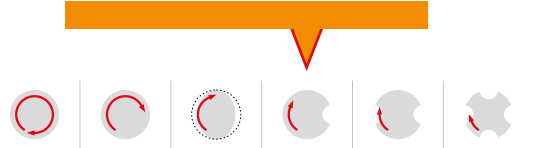

? OEHT 0906AEER-MM

OFKR 07-M

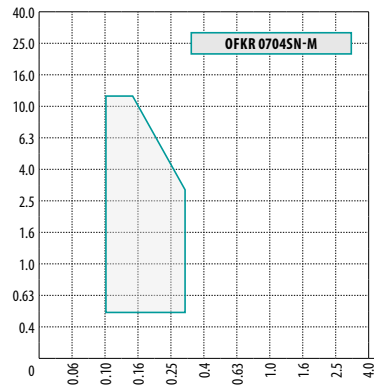
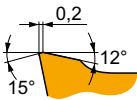

P	M	K	N	S	H
<input checked="" type="checkbox"/>	<input checked="" type="checkbox"/>	<input checked="" type="checkbox"/>	<input checked="" type="checkbox"/>	<input checked="" type="checkbox"/>	<input checked="" type="checkbox"/>
f 0.1 – 0.3					
a _p 0.5 – 12.0					

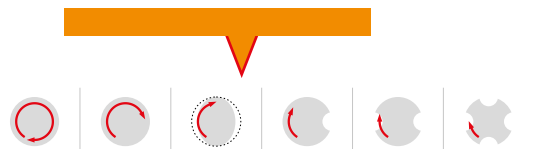

? OFKR 0704SN-M

PDKT 09-FM

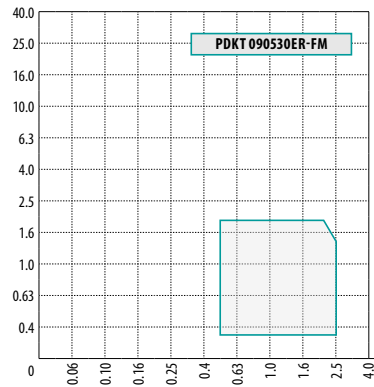
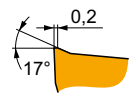

P	M	K	N	S	H
<input checked="" type="checkbox"/>	<input checked="" type="checkbox"/>	<input checked="" type="checkbox"/>	<input checked="" type="checkbox"/>	<input checked="" type="checkbox"/>	<input checked="" type="checkbox"/>
f 0.50 – 2.50					
a _p 0.3 – 2.0					

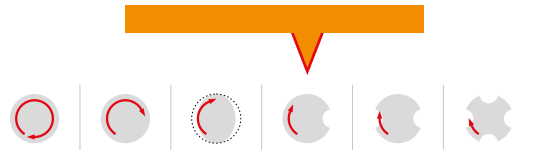

? PDKT 090530ER-FM

PDKX 09-FM

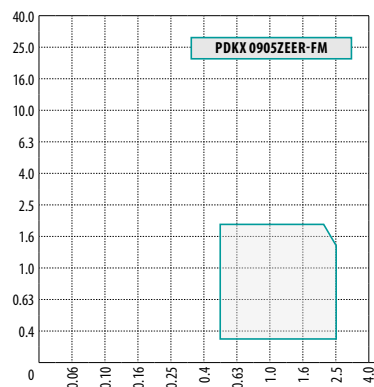
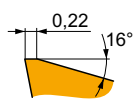

P	M	K	N	S	H
<input checked="" type="checkbox"/>	<input checked="" type="checkbox"/>	<input checked="" type="checkbox"/>	<input checked="" type="checkbox"/>	<input checked="" type="checkbox"/>	<input checked="" type="checkbox"/>
f 0.50 – 2.50					
a _p 0.3 – 2.0					

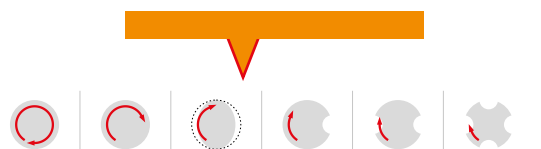



? PDKX 0905ZEER-FM

CHOICE OF CUTTING INSERT

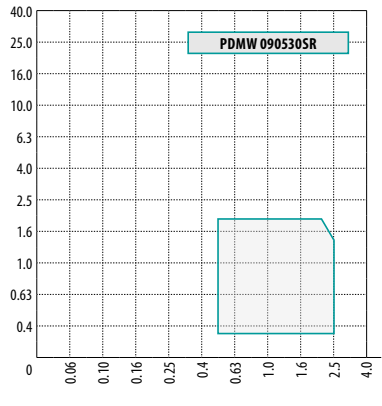
PDMW 09





P	M	K	N	S	H
☑		☑			☑
f → 0.50 – 2.50					
a _p ↓ 0.3 – 2.0					



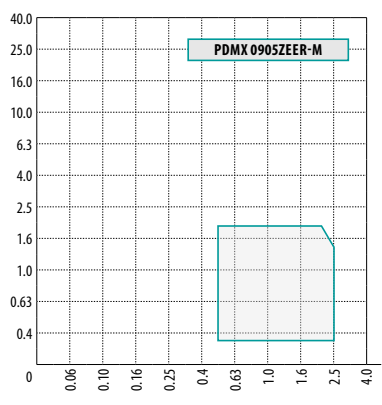

? PDMW 090530SR

PDMX 09-M





P	M	K	N	S	H
☑	☑	☑			
f → 0.50 – 2.50					
a _p ↓ 0.3 – 2.0					



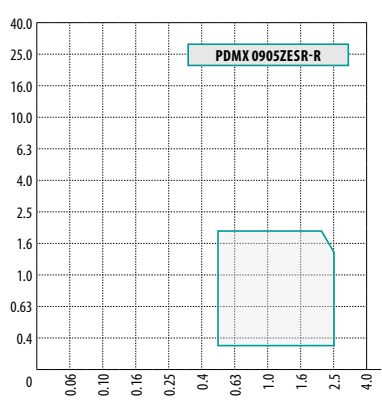

? PDMX 0905ZEER-M

PDMX 09-R





P	M	K	N	S	H
☑		☑			☑
f → 0.50 – 2.50					
a _p ↓ 0.3 – 2.0					



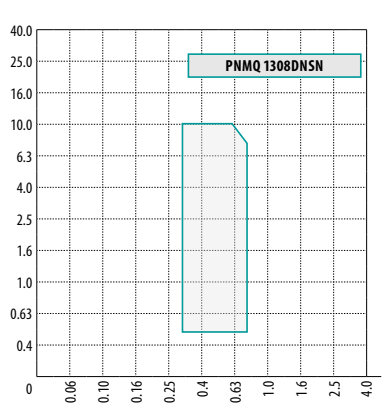

? PDMX 0905ZESR-R

PNMQ 13

P	M	K	N	S	H
☑		☑			☑
f → 0.30 – 0.70					
a _p ↓ 0.5 – 10.0					





? PNMQ 1308DNSN

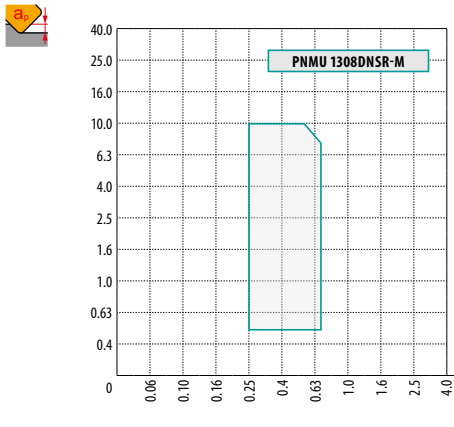
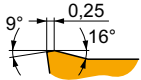

CHOICE OF CUTTING INSERT

PNMU 13-M



P	M	K	N	S	H
■	▣	■	■	▣	▣

f 0.25 – 0.70

a_p 0.5 – 10.0



? PNMU 1308DNSR-M

PPH -CL1

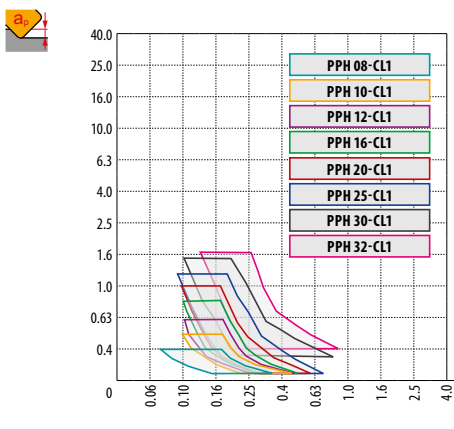

P	M	K	N	S	H
■	▣	■	■	▣	▣

f 0.05 – 0.60 (according to insert size)

a_p 0.1 – 3.2 (according to insert size)



? PPH ..00-CL1

PPH -CL4

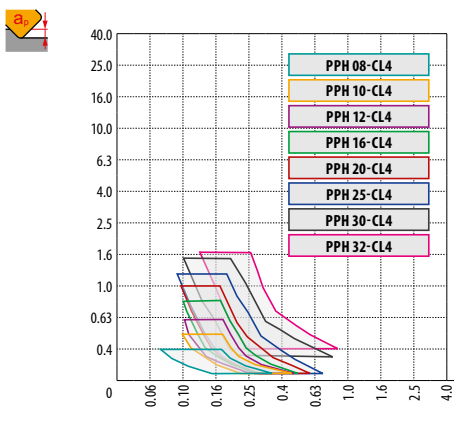

P	M	K	N	S	H
■	▣	■	■	▣	■

f 0.05 – 0.60 (according to insert size)

a_p 0.1 – 3.2 (according to insert size)



? PPH ..00-CL4

PPHE -SM1

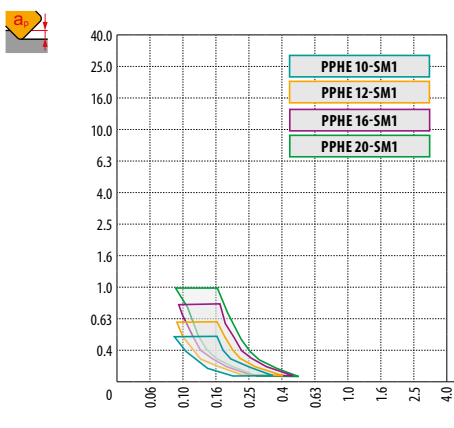
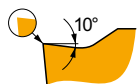

P	M	K	N	S	H
■	▣	■	■	▣	■

f 0.05 – 0.50 (according to insert size)

a_p 0.1 – 2.0 (according to insert size)



? PPHE ..00-SM1



CHOICE OF CUTTING INSERT

PPHF-CE1

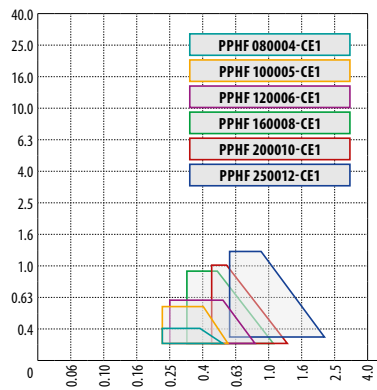
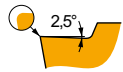

P	M	K	N	S	H
■	▣	■	■	▣	■
	0.20 – 1.50 (according to insert size)				
	0.1 – 1.2 (according to insert size)				
PPHF 080004-CE1, PPHF 100005-CE1 PPHF 120006-CE1, PPHF 160008-CE1 PPHF 200010-CE1, PPHF 250012-CE1					

PPHT-A2

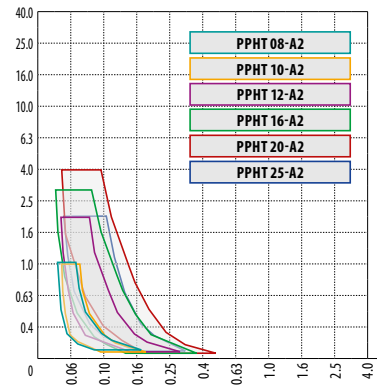
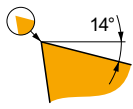

P	M	K	N	S	H
■	▣	■	■	▣	■
	0.05 – 0.50 (according to insert size and radii)				
	0.1 – 4.0 (according to insert size and radii)				
PPHT 08-A2, PPHT 10-A2 PPHT 12-A2, PPHT 16-A2 PPHT 20-A2, PPHT 25-A2					

RC

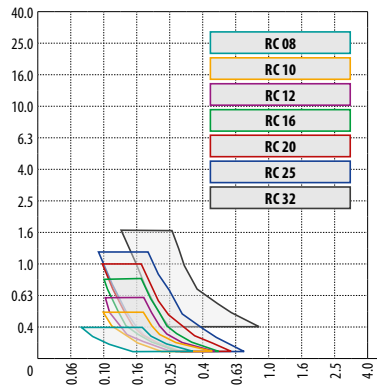

P	M	K	N	S	H
■	▣	■	■	▣	■
	0.10 – 0.60 (according to insert size)				
	0.3 – 3.2 (according to insert size)				
RC 08, RC 10, RC 12, RC 16, RC 20, RC 25, RC 32					

RC-F

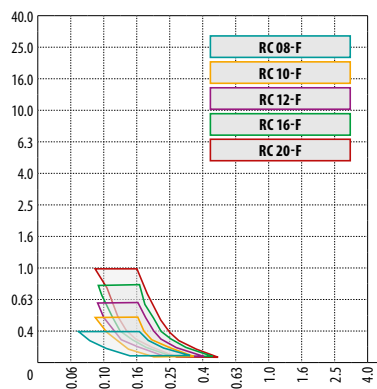

P	M	K	N	S	H
■	▣	■	■	▣	■
	0.05 – 0.60 (according to insert size)				
	0.3 – 3.2 (according to insert size)				
RC 08-F, RC 10-F, RC 12-F RC 16-F, RC 20-F					



CHOICE OF CUTTING INSERT

RCMT 12EN-R

a_p

P	M	K	N	S	H
■	■	■	■	■	■

f 0.20 – 0.50

a_p 0.3 – 6.0

? RCMT 1204MOEN-R

RCMT-F

RCMT 10	0.08
RCMT 12	-
RCMT 16	-
RCMT 20	0.25

a_p

P	M	K	N	S	H
■	■	■	■	■	■

f 0.05 – 0.30 (according to insert size)

a_p 0.3 – 10.0 (according to insert size)

? RCMT 10T3MOSN-F, RCMT 1204MOEN-F
RCMT 1606MOEN-F, RCMT 2006MOSN-F

RCMT-M

RCMT 10	0.10
RCMT 12	0.14
RCMT 16	0.13
RCMT 20	0.22

a_p

P	M	K	N	S	H
■	■	■	■	■	■

f 0.10 – 0.45 (according to insert size)

a_p 0.3 – 10.0 (according to insert size)

? RCMT 10T3MOSN-M, RCMT 1204MOSN-M
RCMT 1606MOSN-M, RCMT 2006MOSN-M

RCMT-R

RCMT 10	0.15
RCMT 20	0.17

a_p

P	M	K	N	S	H
■	■	■	■	■	■

f 0.15 – 0.60 (according to insert size)

a_p 0.3 – 10.0 (according to insert size)

? RCMT 10T3MOSN-R
RCMT 2006MOSN-R



CHOICE OF CUTTING INSERT

RCMT SN-R

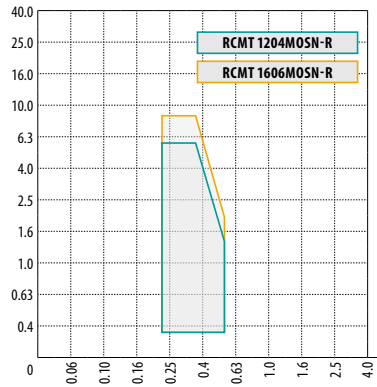
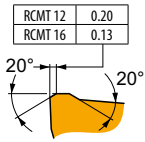

P	M	K	N	S	H
■	■	■	■	■	■
0.15 – 0.60 (according to insert size)					
0.3 – 10.0 (according to insert size)					
RCMT 1204MOSN-R RCMT 1606MOSN-R					

RDET

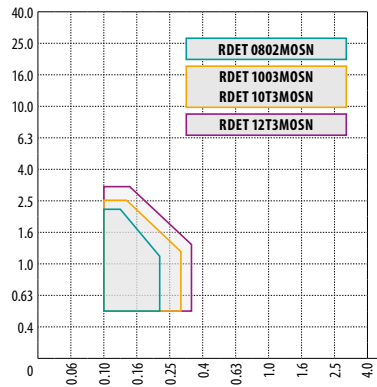
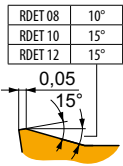

P	M	K	N	S	H
■	■	■	■	■	■
0.10 – 0.35 (according to insert size)					
0.5 – 3.0 (according to insert size)					
RDET 0802MOSN, RDET 1003MOSN RDET 10T3MOSN, RDET 12T3MOSN					

RDEW

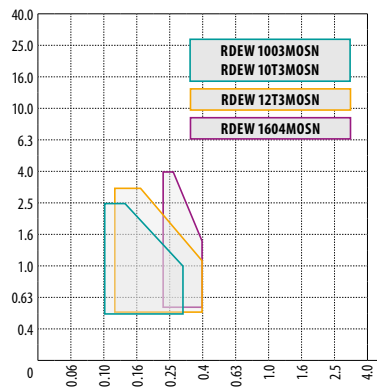
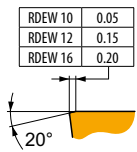

P	M	K	N	S	H
■	■	■	■	■	■
0.10 – 0.40 (according to insert size)					
0.5 – 4.0 (according to insert size)					
RDEW 1003MOSN, RDEW 10T3MOSN RDEW 12T3MOSN, RDEW 1604MOSN					

RDEX 12

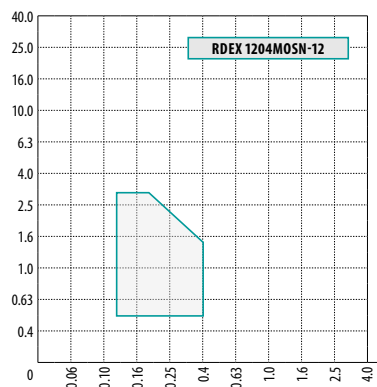

P	M	K	N	S	H
■	■	■	■	■	■
0.12 – 0.40					
0.5 – 3.0					
RDEX 1604MOSN-12					

CHOICE OF CUTTING INSERT

RDEX 16

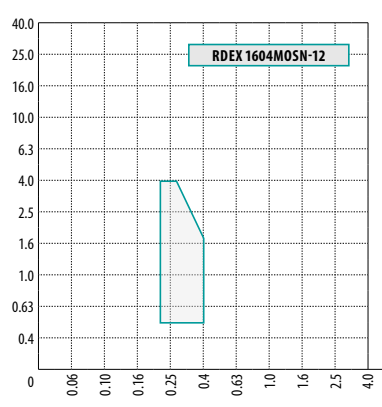



P	M	K	N	S	H
■	▣	■	■	▣	■
f	0.22 – 0.40				
a_p	0.5 – 4.0				

RDEX 1604MOSN-12

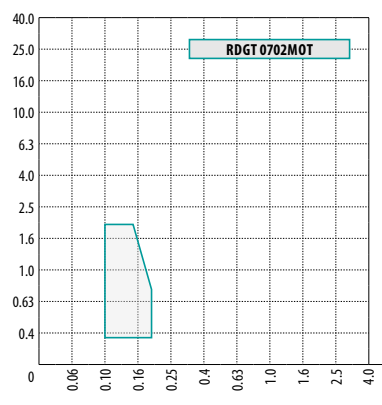

RDGT 07





P	M	K	N	S	H
■	▣	■	■	▣	■
f	0.10 – 0.20				
a_p	0.3 – 2.0				

RDGT 0702MOT

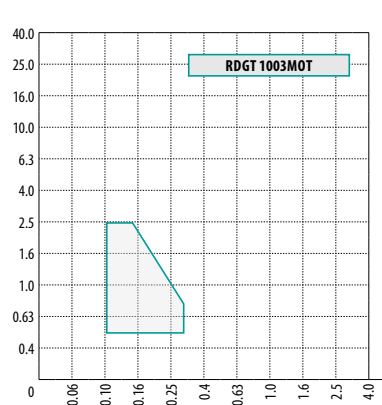

RDGT 10





P	M	K	N	S	H
■	▣	■	■	▣	■
f	0.10 – 0.30				
a_p	0.5 – 2.5				

RDGT 1003MOT

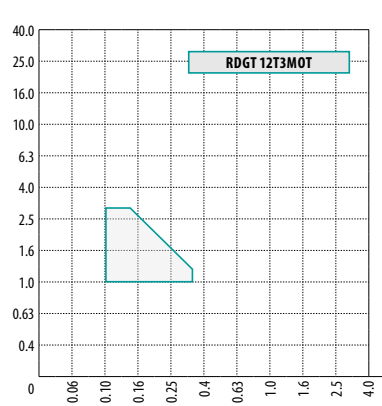

RDGT 12

P	M	K	N	S	H
■	▣	■	■	▣	■
f	0.10 – 0.35				
a_p	1.0 – 3.0				

RDGT 12T3MOT





CHOICE OF CUTTING INSERT

RDGT 12-F

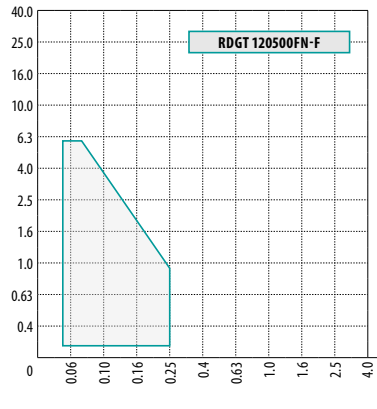
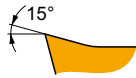

P	M	K	N	S	H
■	▣	■	▣	■	■
f → 0.05 – 0.25					
a _p ↓ 0.2 – 6.0					
RDGT 120500FN-F					

RDGT 12-FM

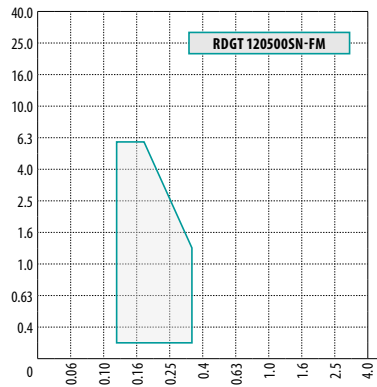
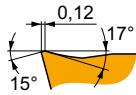

P	M	K	N	S	H
■	▣	▣	■	■	■
f → 0.12 – 0.35					
a _p ↓ 0.2 – 6.0					
RDGT 120500SN-FM					

RDHT -FA



RDHT 07	15.9°
RDHT 10	17.5°
RDHT 12	10.2°
RDHT 16	22.0°

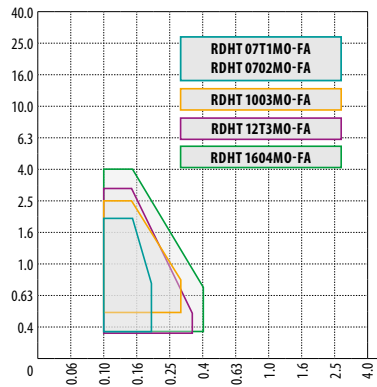
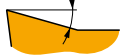

P	M	K	N	S	H
■	■	■	■	■	■
f → 0.10 – 0.40 (according to insert size)					
a _p ↓ 0.3 – 4.0 (according to insert size)					
RDHT 07T1M0-FA, RDHT 0702M0-FA RDHT 1003M0-FA, RDHT 12T3M0-FA RDHT 1604M0-FA					

RDHX 05

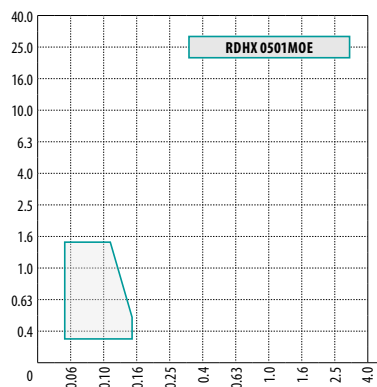

P	M	K	N	S	H
▣	■	■	■	■	■
f → 0.05 – 0.15					
a _p ↓ 0.3 – 1.5					
RDHX 0501MOE					



CHOICE OF CUTTING INSERT

RDHX MOT

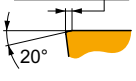
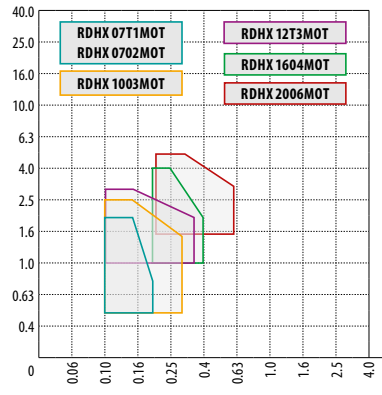

RDHX 07	0.12
RDHX 10	0.15
RDHX 12	0.15
RDHX 16	0.20
RDHX 20	0.20

P	M	K	N	S	H
█		█			█

f 0.10 – 0.60 (according to insert size)

a_p 0.5 – 5.0 (according to insert size)

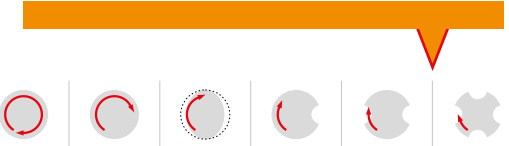

? RDHX 07T1MOT, RDHX 0702MOT
RDHX 1003MOT, RDHX 12T3MOT
RDHX 1604MOT, RDHX 2006MOT

RDMT

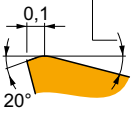
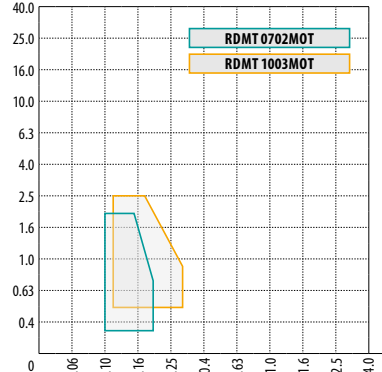

RDMT 07	14°
RDMT 10	15°

P	M	K	N	S	H
█	█	█			

f 0.10 – 0.30 (according to insert size)

a_p 0.3 – 2.5 (according to insert size)

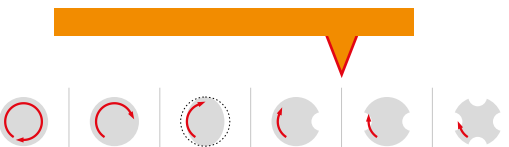

? RDMT 0702MOT
RDMT 1003MOT

RDMT 12

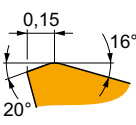
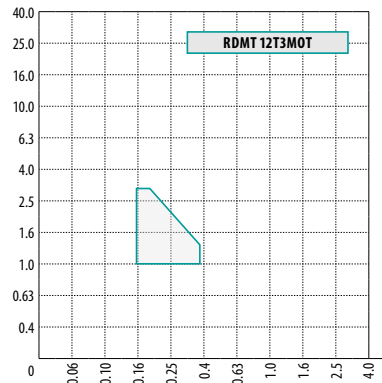
P	M	K	N	S	H
█	█	█			

f 0.15 – 0.35

a_p 1.0 – 3.0

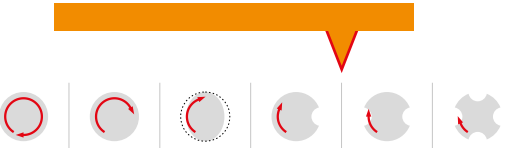

? RDMT 12T3MOT

RDMT -R

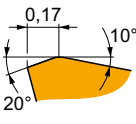
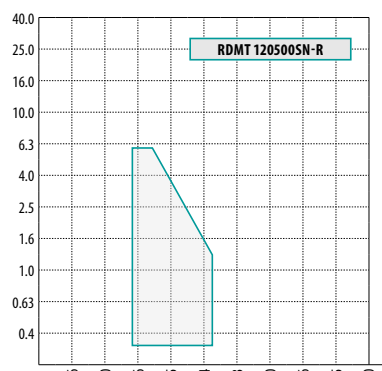
P	M	K	N	S	H
█		█			

f 0.17 – 0.45

a_p 0.3 – 6.0

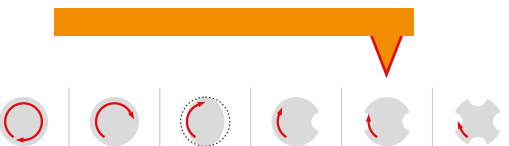

? RDMT 120500SN-R



CHOICE OF CUTTING INSERT

RDMX



RDMX 10	0.12
RDMX 12	0.15
RDMX 16	0.20

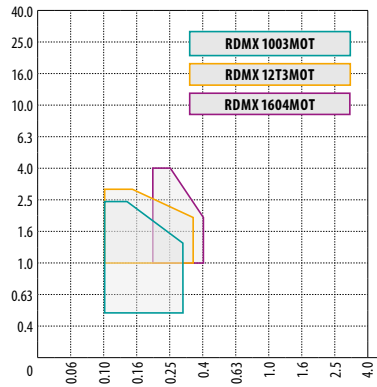
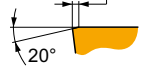

P	M	K	N	S	H
☐	☐	■	☐	☐	■
f	0.10 – 0.40 (according to insert size)				
a_p	0.5 – 4.0 (according to insert size)				
?	RDMX 1003MOT RDMX 12T3MOT RDMX 1604MOT				

REHT -M

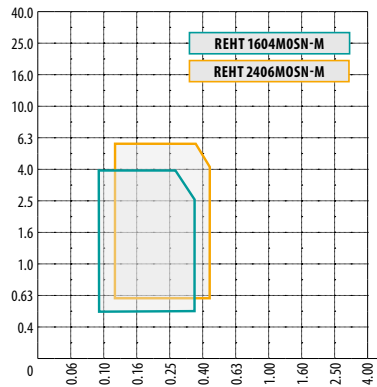
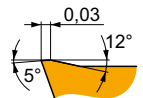

P	M	K	N	S	H
■	■	■	☐	☐	☐
f	0.08 – 0.45 (according to insert size)				
a_p	0.5 – 6.0 (according to insert size)				
?	REHT 1604M05N-M REHT 2406M05N-M				

REHT -MM

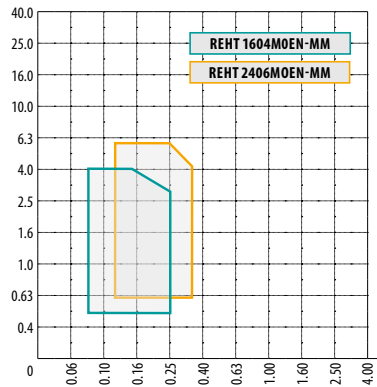
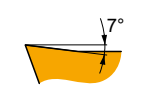

P	M	K	N	S	H
☐	■	■	☐	■	☐
f	0.08 – 0.35 (according to insert size)				
a_p	0.5 – 6.0 (according to insert size)				
?	REHT 1604M0EN-MM REHT 2406M0EN-MM				

RPET 12

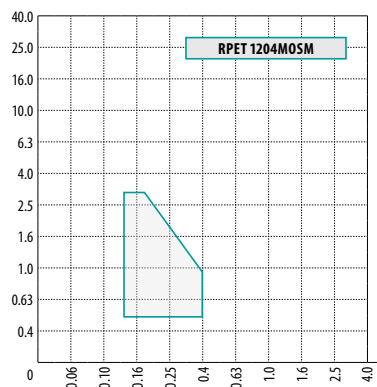
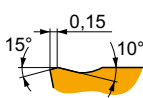



P	M	K	N	S	H
■	☐	☐	☐	☐	☐
f	0.12 – 0.40				
a_p	0.5 – 3.0				
?	RPET 1204M0SM				

CHOICE OF CUTTING INSERT

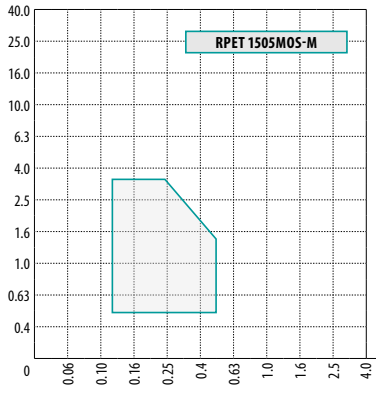

RPET 15-M

P	M	K	N	S	H
■	▣	▣	■	▣	■
f → 0.12 – 0.50					
a _p ↓ 0.5 – 3.5					
					
					
 RPET 1505MOS-M					

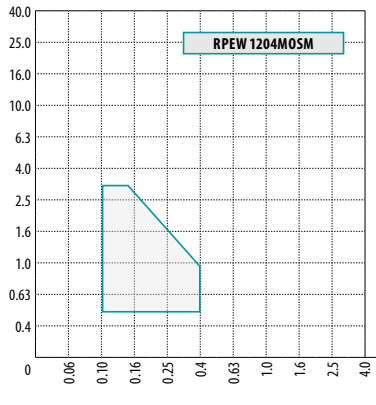

RPEW 12

P	M	K	N	S	H
▣	■	■	■	■	■
f → 0.10 – 0.40					
a _p ↓ 0.5 – 3.0					
					
					
 RPEW 1204MOSM					

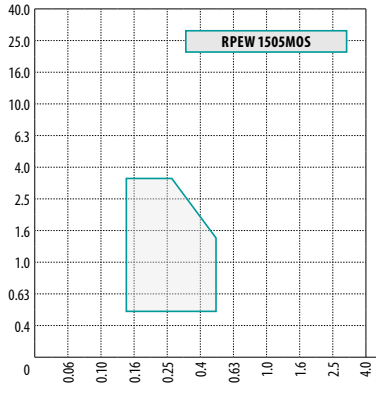

RPEW 15

P	M	K	N	S	H
▣	■	■	■	■	■
f → 0.15 – 0.50					
a _p ↓ 0.5 – 3.5					
					
					
 RPEW 1505MOS					

RPEX -12

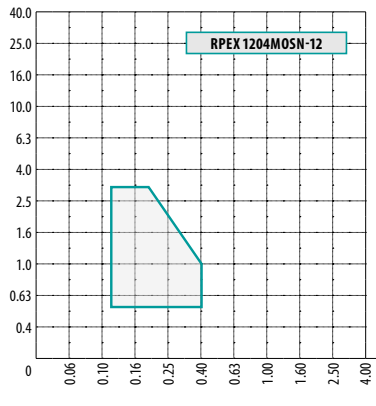
P	M	K	N	S	H
■	▣	■	■	▣	■
f → 0.12 – 0.40					
a _p ↓ 0.5 – 3.0					
					
					
 RPEX 1204MOSN-12					

CHOICE OF CUTTING INSERT

SBKX 22

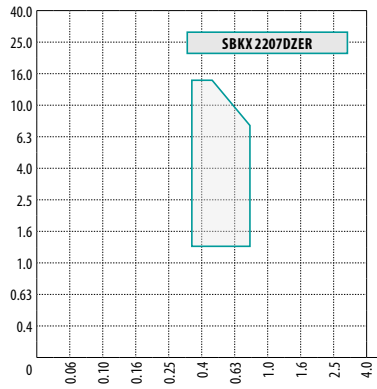

P	M	K	N	S	H
■	■	■	■	■	■
f 0.35 – 0.80					
a _p 1.5 – 15.0					
SBKX 2207DZER					

SBMR 22

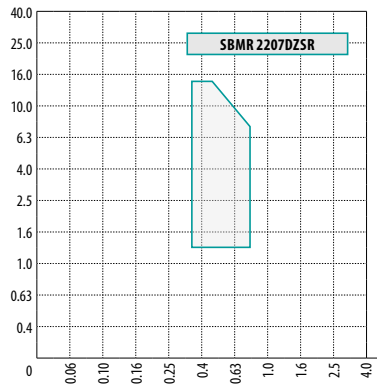
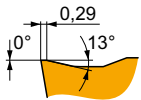

P	M	K	N	S	H
■	■	■	■	■	■
f 0.35 – 0.80					
a _p 1.5 – 15.0					
SBMR 2207DZSR					

SBMR 22-R

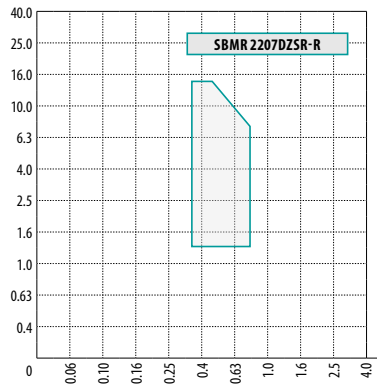
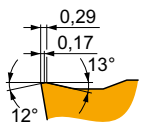

P	M	K	N	S	H
■	■	■	■	■	■
f 0.35 – 0.80					
a _p 1.5 – 15.0					
SBMR 2207DZSR-R					

SDEW 09EN

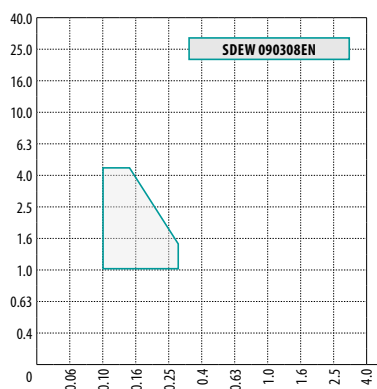

P	M	K	N	S	H
■	■	■	■	■	■
f 0.10 – 0.30					
a _p 1.0 – 4.5					
SDEW 090308EN					

CHOICE OF CUTTING INSERT

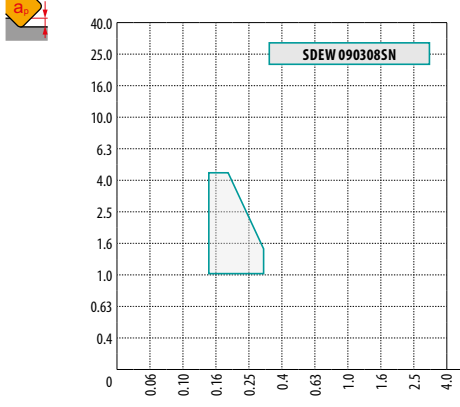

SDEW 09SN

P	M	K	N	S	H
☐	☐	■	☐	☐	☐

f 0.15 – 0.30

a_p 1.0 – 4.5

? SDEW 090308SN

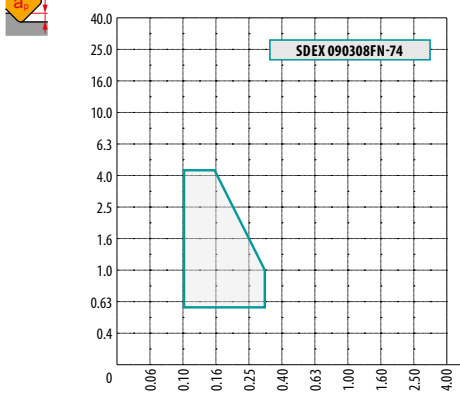

SDEX 09-74

P	M	K	N	S	H
■	☐	☐	☐	☐	☐

f 0.10 – 0.30

a_p 0.5 – 4.5

? SDEX 090308FN-74

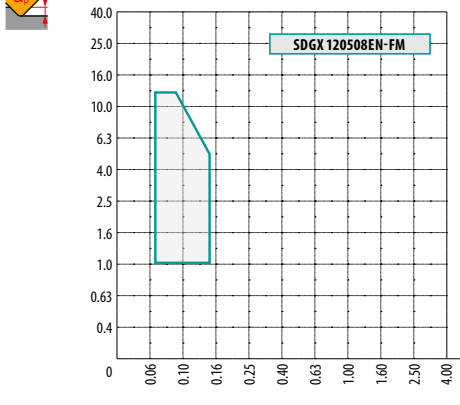

SDGX 12-FM

P	M	K	N	S	H
■	■	☐	☐	■	☐

f 0.07 – 0.15

a_p 1.0 – 12.0

? SDGX 120508EN-FM

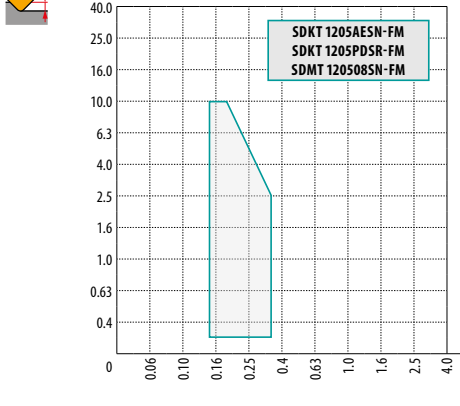

SDK(M)T 12-FM (IM)

P	M	K	N	S	H
■	☐	☐	☐	☐	☐

f 0.15 – 0.35

a_p 0.2 – 10.0

**? SDKT 1205AESN-FM
SDKT 1205PDSR-FM
SDMT 120508SN-FM**

CHOICE OF CUTTING INSERT

SDKT 12-F (IM)

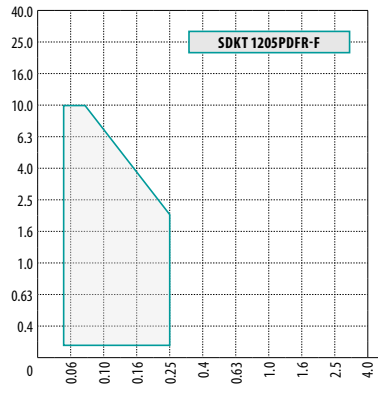
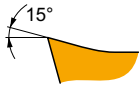

P	M	K	N	S	H
■	▣	■	▣	■	■
f	0.05 – 0.25				
a _p	0.2 – 10.0				
SDKT 1205PDFR-F					

SDMT 12-F

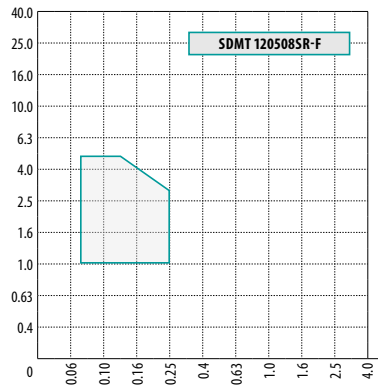
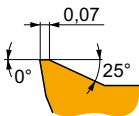
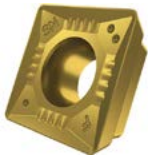

P	M	K	N	S	H
■	▣	▣	▣	▣	■
f	0.07 – 0.25				
a _p	1.0 – 5.0				
SDMT 120508SR-F					

SDMT 12-F (IM)

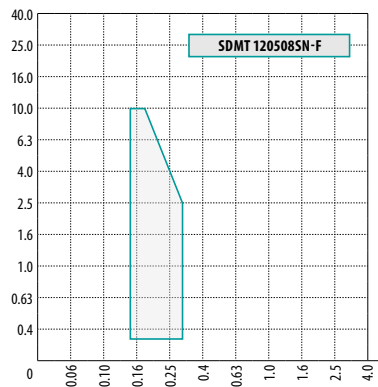
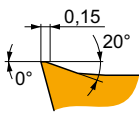
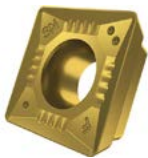

P	M	K	N	S	H
■	▣	■	▣	■	■
f	0.15 – 0.30				
a _p	0.3 – 10.0				
SDMT 120508SN-F					

SDMT 12-M

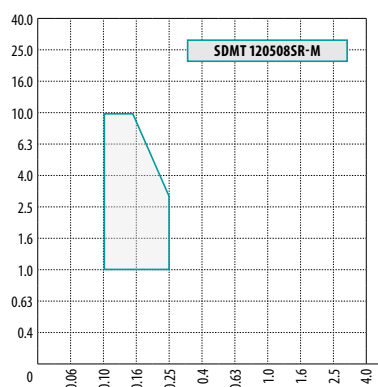
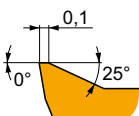

P	M	K	N	S	H
■	■	▣	■	▣	■
f	0.10 – 0.25				
a _p	1.0 – 10.0				
SDMT 120508SR-M					



CHOICE OF CUTTING INSERT

SDMT 12-R

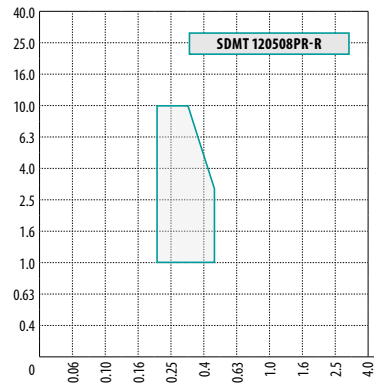
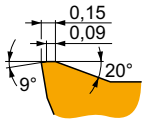

P	M	K	N	S	H
■	■	■	■	■	■

f 0.20 – 0.45

a_p 1.0 – 10.0

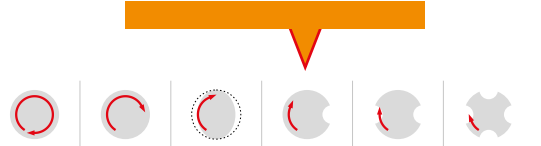

? SDMT 120508PR-R

SDMT 12-R (IM)

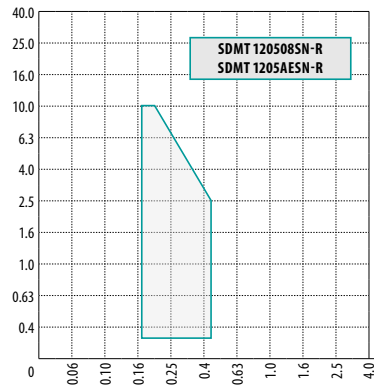
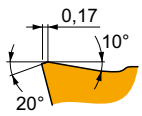

P	M	K	N	S	H
■	■	■	■	■	■

f 0.17 – 0.45

a_p 0.3 – 10.0



? SDMT 120508SN-R
SDMT 1205AESN-R

SDMX 12-M

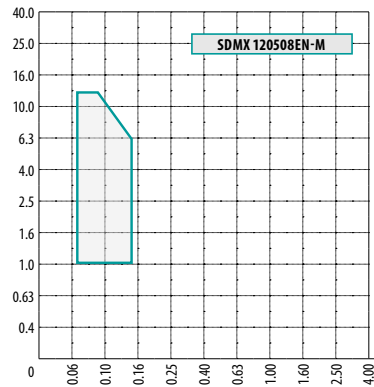
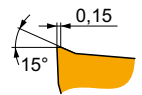

P	M	K	N	S	H
■	■	■	■	■	■

f 0.07 – 0.15

a_p 1.0 – 12.0

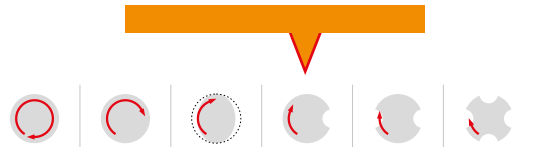

? SDMX 120508EN-M

SEEN 12FN

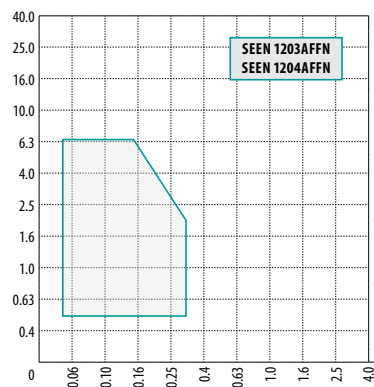
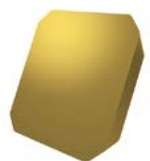

P	M	K	N	S	H
■	■	■	■	■	■

f 0.05 – 0.40 (according to insert size)

a_p 0.5 – 6.5

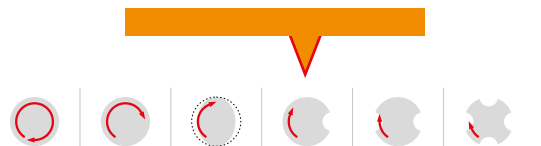

? SEEN 1203AFFN
SEEN 1204AFFN



CHOICE OF CUTTING INSERT

SEEN SN

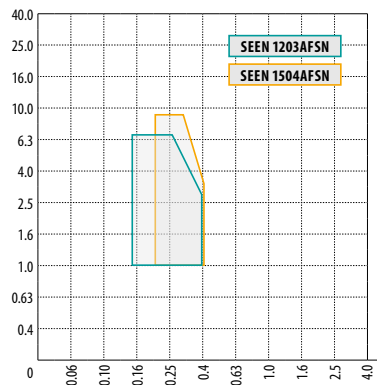
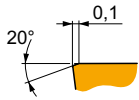

P	M	K	N	S	H
■	■	■	■	■	■
f 0.15 – 0.40 (according to insert size)					
a_p 0.5 – 9.0 (according to insert size)					
? SEEN 1203AFSN SEEN 1504AFSN					

SEER EN

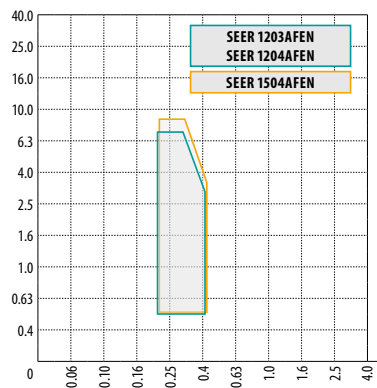
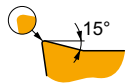

P	M	K	N	S	H
■	■	■	■	■	■
f 0.20 – 0.40 (according to insert size)					
a_p 0.5 – 9.0 (according to insert size)					
? SEER 1203AFEN SEER 1204AFEN SEER 1504AFEN					

SEER SN

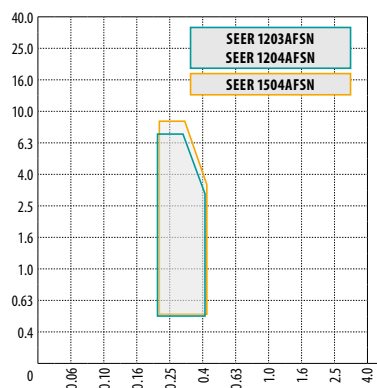
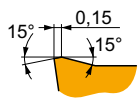

P	M	K	N	S	H
■	■	■	■	■	■
f 0.20 – 0.40 (according to insert size)					
a_p 1.0 – 9.0 (according to insert size)					
? SEER 1203AFSN SEER 1204AFSN SEER 1504AFSN					

SEET 09

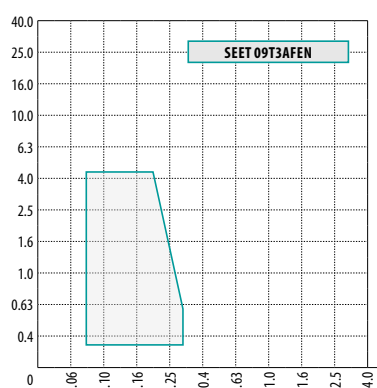
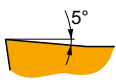

P	M	K	N	S	H
■	■	■	■	■	■
f 0.08 – 0.30					
a_p 0.3 – 4.5					
? SEET 09T3AFEN					

CHOICE OF CUTTING INSERT

SEET 12EN

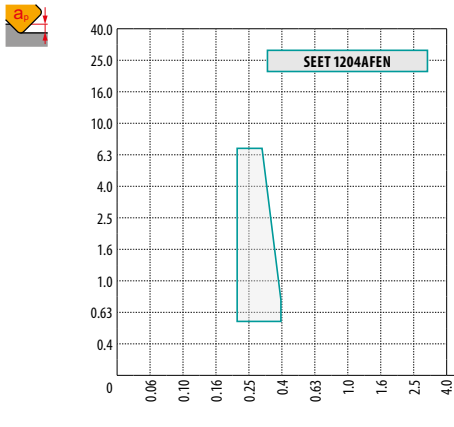
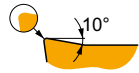

P	M	K	N	S	H
■	■	▣	■	▣	■
f 0.20 - 0.40					
a _p 0.5 - 6.5					
SEET 1204AFEN					

SEET 12SN

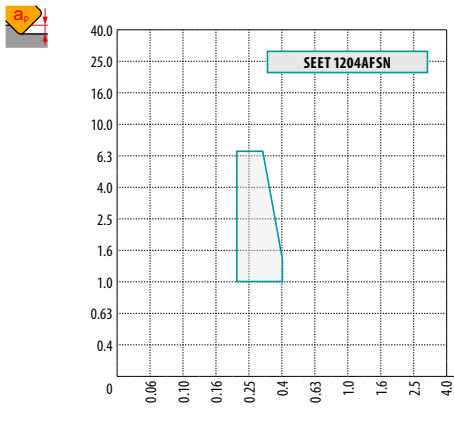
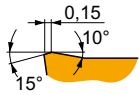

P	M	K	N	S	H
■	■	▣	■	▣	■
f 0.20 - 0.40					
a _p 1.0 - 6.5					
SEET 1204AFSN					

SEET 12-FA

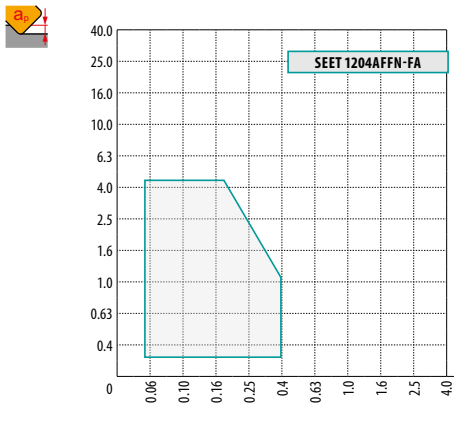
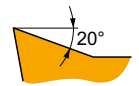
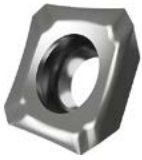

P	M	K	N	S	H
■	■	▣	■	▣	■
f 0.05 - 0.40					
a _p 0.2 - 4.5					
SEET 1204AFFN-FA					

SEET 12-PM

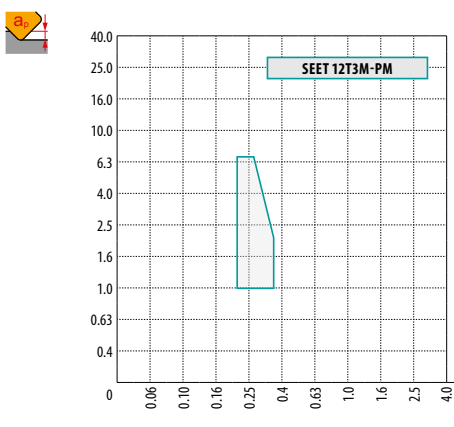
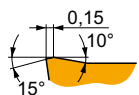

P	M	K	N	S	H
■	▣	■	■	▣	■
f 0.20 - 0.35					
a _p 1.0 - 6.5					
SEET 12T3M-PM					

CHOICE OF CUTTING INSERT

SEEW 12 EN

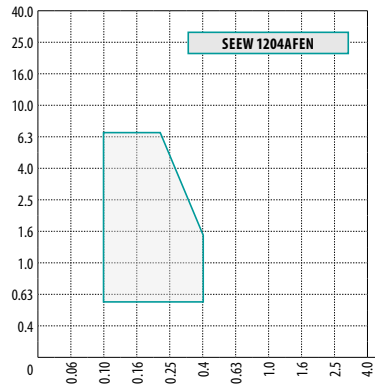

P	M	K	N	S	H
☐	☐	☐	☐	☐	☐
f		0.10 – 0.40			
a _p		0.5 – 6.5			
SEEW 1204AFEN					

SEEW 12 SN

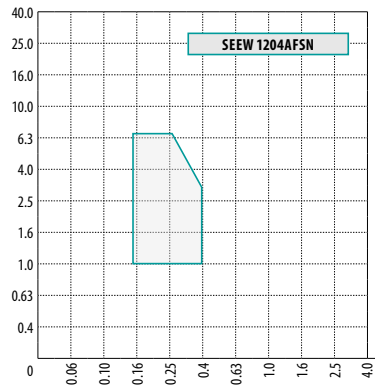
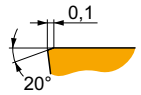

P	M	K	N	S	H
☐	☐	☐	☐	☐	☐
f		0.15 – 0.40			
a _p		1.0 – 6.5			
SEEW 1204AFSN					

SEMT 09

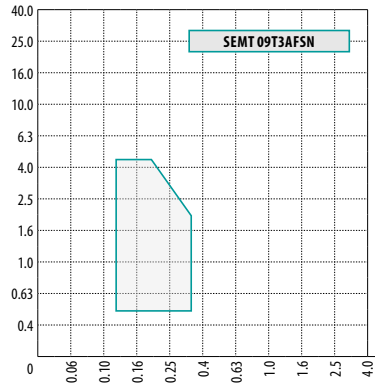
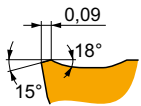

P	M	K	N	S	H
☐	☐	☐	☐	☐	☐
f		0.12 – 0.35			
a _p		0.5 – 4.5			
SEMT 09T3AFSN					

SFCN 12

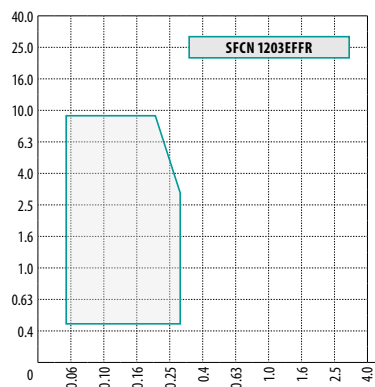

P	M	K	N	S	H
☐	☐	☐	☐	☐	☐
f		0.05 – 0.30			
a _p		0.5 – 9.0			
SFCN 1203EFFR					



CHOICE OF CUTTING INSERT

SNET 13-M

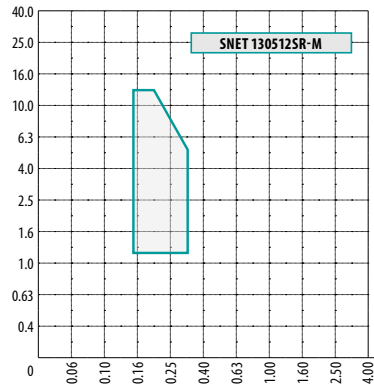
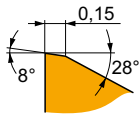

P	M	K	N	S	H
■	■	■	■	■	■

f 0.15 – 0.35

a_p 1.2 – 12.0



? SNET 130512SR-M

SNGX 11-M

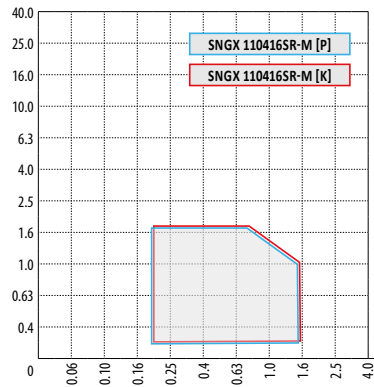
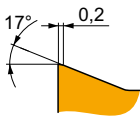

P	M	K	N	S	H
■	■	■	■	■	■

f 0.20 – 1.50

a_p 0.2 – 1.7



? SNGX 110416SR-M

SNGX 11-MM

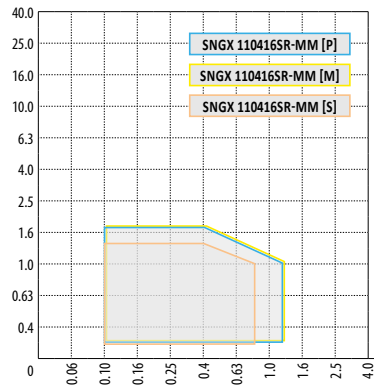
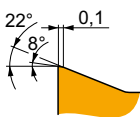

P	M	K	N	S	H
■	■	■	■	■	■

f 0.10 – 1.20

a_p 0.2 – 1.7



? SNGX 110416SR-MM

SNGX 13-M

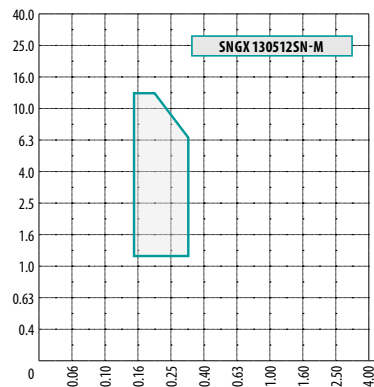
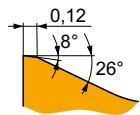

P	M	K	N	S	H
■	■	■	■	■	■

f 0.15 – 0.35

a_p 1.2 – 12.0





? SNGX 130512SN-M



CHOICE OF CUTTING INSERT

SNGX 13-R





P	M	K	N	S	H
■	■	■	■	■	■
f	0.15 – 0.40				
a_p	1.2 – 12.0				

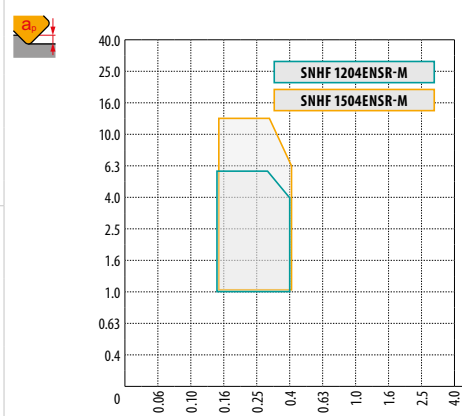

? SNGX 130512PN-R

SNHF -M





P	M	K	N	S	H
■	■	■	■	■	■
f	0.15 – 0.40				
a_p	1.0 – 13.5 (according to insert size)				

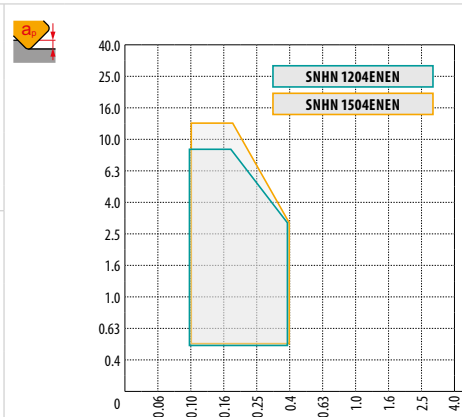

**? SNHF 1204ENSR-M
SNHF 1504ENSR-M**

SNHN





P	M	K	N	S	H
■	■	■	■	■	■
f	0.10 – 0.40				
a_p	0.5 – 13.5 (according to insert size)				

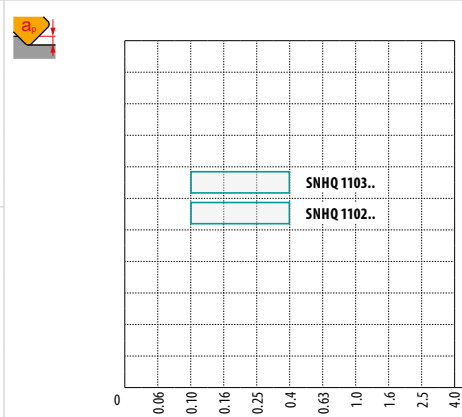

**? SNHN 1204ENEN
SNHN 1504ENEN**

SNHQ 11











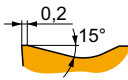







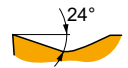





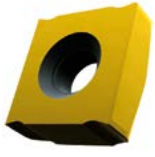
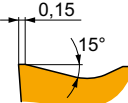



P	M	K	N	S	H
■	■	■	■	■	■
f	0.10 – 0.40				
a_p	-				

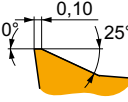

? SNHQ 110.AZTN



CHOICE OF CUTTING INSERT

<p style="writing-mode: vertical-rl; transform: rotate(180deg);">SNHQ 12TN</p>	 		<table border="1"> <thead> <tr> <th>P</th> <th>M</th> <th>K</th> <th>N</th> <th>S</th> <th>H</th> </tr> </thead> <tbody> <tr> <td>■</td> <td>▣</td> <td>■</td> <td>■</td> <td>■</td> <td>■</td> </tr> <tr> <td colspan="6"> f 0.10 – 0.50 (according to insert type) </td> </tr> <tr> <td colspan="6"> a_p – </td> </tr> <tr> <td colspan="6" style="text-align: center;">  </td> </tr> <tr> <td colspan="6" style="text-align: center;">  </td> </tr> <tr> <td colspan="6"> ? SNHQ 1203AZTN, SNHQ 12T3AZTN SNHQ 1204AZTN, SNHQ 1205AZTN SNHQ 1207AZTN </td> </tr> </tbody> </table>	P	M	K	N	S	H	■	▣	■	■	■	■	f 0.10 – 0.50 (according to insert type)						a_p –																		? SNHQ 1203AZTN, SNHQ 12T3AZTN SNHQ 1204AZTN, SNHQ 1205AZTN SNHQ 1207AZTN					
P	M	K	N	S	H																																								
■	▣	■	■	■	■																																								
f 0.10 – 0.50 (according to insert type)																																													
a_p –																																													
																																													
																																													
? SNHQ 1203AZTN, SNHQ 12T3AZTN SNHQ 1204AZTN, SNHQ 1205AZTN SNHQ 1207AZTN																																													
<p style="writing-mode: vertical-rl; transform: rotate(180deg);">SNHQ 12EN</p>	 		<table border="1"> <thead> <tr> <th>P</th> <th>M</th> <th>K</th> <th>N</th> <th>S</th> <th>H</th> </tr> </thead> <tbody> <tr> <td>■</td> <td>▣</td> <td>■</td> <td>■</td> <td>■</td> <td>■</td> </tr> <tr> <td colspan="6"> f 0.10 – 0.50 (according to insert type) </td> </tr> <tr> <td colspan="6"> a_p – </td> </tr> <tr> <td colspan="6" style="text-align: center;">  </td> </tr> <tr> <td colspan="6" style="text-align: center;">  </td> </tr> <tr> <td colspan="6"> ? SNHQ 1203AZEN, SNHQ 1204AZEN SNHQ 1205AZEN, SNHQ 1207AZEN </td> </tr> </tbody> </table>	P	M	K	N	S	H	■	▣	■	■	■	■	f 0.10 – 0.50 (according to insert type)						a_p –																		? SNHQ 1203AZEN, SNHQ 1204AZEN SNHQ 1205AZEN, SNHQ 1207AZEN					
P	M	K	N	S	H																																								
■	▣	■	■	■	■																																								
f 0.10 – 0.50 (according to insert type)																																													
a_p –																																													
																																													
																																													
? SNHQ 1203AZEN, SNHQ 1204AZEN SNHQ 1205AZEN, SNHQ 1207AZEN																																													
<p style="writing-mode: vertical-rl; transform: rotate(180deg);">SNHQ 12TRL</p>	 		<table border="1"> <thead> <tr> <th>P</th> <th>M</th> <th>K</th> <th>N</th> <th>S</th> <th>H</th> </tr> </thead> <tbody> <tr> <td>■</td> <td>▣</td> <td>▣</td> <td>■</td> <td>■</td> <td>■</td> </tr> <tr> <td colspan="6"> f 0.10 – 0.50 (according to insert type) </td> </tr> <tr> <td colspan="6"> a_p – </td> </tr> <tr> <td colspan="6" style="text-align: center;">  </td> </tr> <tr> <td colspan="6" style="text-align: center;">  </td> </tr> <tr> <td colspan="6"> ? SNHQ 1203..TRL, SNHQ 1204..TRL SNHQ 1205..TRL, SNHQ 1207..TRL </td> </tr> </tbody> </table>	P	M	K	N	S	H	■	▣	▣	■	■	■	f 0.10 – 0.50 (according to insert type)						a_p –																		? SNHQ 1203..TRL, SNHQ 1204..TRL SNHQ 1205..TRL, SNHQ 1207..TRL					
P	M	K	N	S	H																																								
■	▣	▣	■	■	■																																								
f 0.10 – 0.50 (according to insert type)																																													
a_p –																																													
																																													
																																													
? SNHQ 1203..TRL, SNHQ 1204..TRL SNHQ 1205..TRL, SNHQ 1207..TRL																																													
<p style="writing-mode: vertical-rl; transform: rotate(180deg);">SNK(M)T 12-M</p>	 		<table border="1"> <thead> <tr> <th>P</th> <th>M</th> <th>K</th> <th>N</th> <th>S</th> <th>H</th> </tr> </thead> <tbody> <tr> <td>■</td> <td>■</td> <td>▣</td> <td>■</td> <td>▣</td> <td>■</td> </tr> <tr> <td colspan="6"> f 0.15 – 0.50 </td> </tr> <tr> <td colspan="6"> a_p 1.0 – 6.5 </td> </tr> <tr> <td colspan="6" style="text-align: center;">  </td> </tr> <tr> <td colspan="6" style="text-align: center;">  </td> </tr> <tr> <td colspan="6"> ? SNKT 1205AZSR-M SNMT 1205AZSR-M </td> </tr> </tbody> </table>	P	M	K	N	S	H	■	■	▣	■	▣	■	f 0.15 – 0.50						a_p 1.0 – 6.5																		? SNKT 1205AZSR-M SNMT 1205AZSR-M					
P	M	K	N	S	H																																								
■	■	▣	■	▣	■																																								
f 0.15 – 0.50																																													
a_p 1.0 – 6.5																																													
																																													
																																													
? SNKT 1205AZSR-M SNMT 1205AZSR-M																																													



CHOICE OF CUTTING INSERT

SNKX

P	M	K	N	S	H
■	■	■	■	■	■
f 0.05 – 0.40					
a _p 0.5 – 13.5 (according to insert size)					
SNKX 1204ENFN SNKX 1504ENFN					

SNMT 12-R

P	M	K	N	S	H
■	■	■	■	■	■
f 0.18 – 0.50					
a _p 1.0 – 6.5					
SNMT 1205AZSR-R					

SNUN

P	M	K	N	S	H
■	■	■	■	■	■
f 0.10 – 0.40					
a _p 0.5 – 13.5 (according to insert size)					
SNUN 120408 SNUN 120412 SNUN 150412					

SOMT 05-M

P	M	K	N	S	H
■	■	■	■	■	■
f 0.03 – 0.12					
a _p 0.4 – 4.5					
SOMT 050204SR-M SOMT 050208SR-M					

CHOICE OF CUTTING INSERT

SOMT 09-M

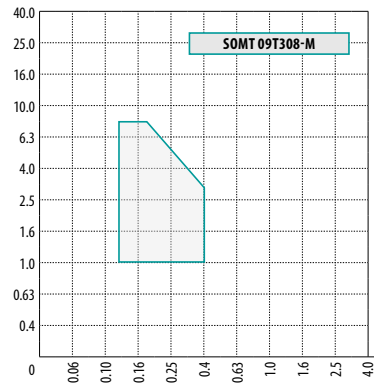
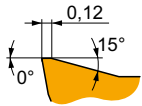

P	M	K	N	S	H
■	■	▣	■	▣	■
f		0.12 – 0.40			
a _p		1.0 – 8.0			

? SOMT 09T308-M

SOMT 09-MI

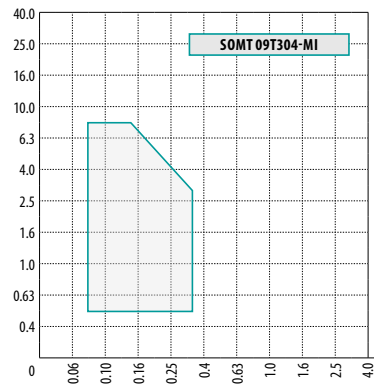
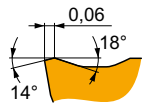
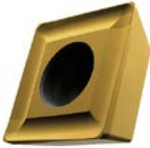

P	M	K	N	S	H
■	■	▣	■	▣	■
f		0.08 – 0.35			
a _p		0.5 – 8.0			

? SOMT 09T304-MI

SOMT 09-P

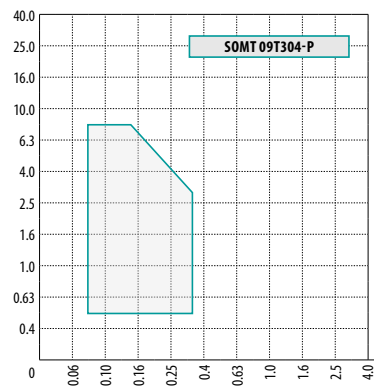
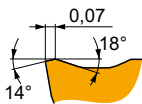

P	M	K	N	S	H
■	▣	▣	■	▣	■
f		0.08 – 0.35			
a _p		0.5 – 8.0			

? SOMT 09T304-P

SPET 12EN

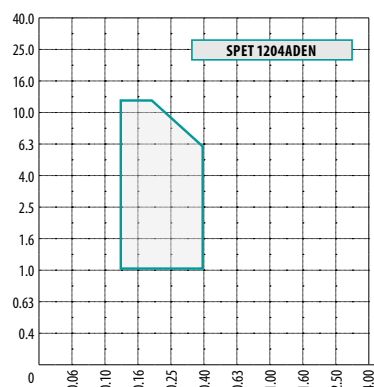
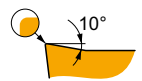

P	M	K	N	S	H
■	▣	■	■	▣	■
f		0.12 – 0.40			
a _p		1.0 – 12.0			

? SPET 1204ADEN

CHOICE OF CUTTING INSERT

SPET 12S

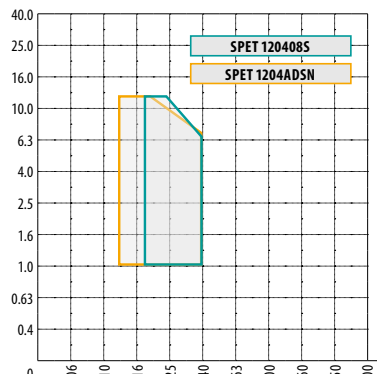
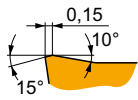

P	M	K	N	S	H
■	■	■	■	■	■
f 0.12 – 0.40 (according to insert type)					
a _p 1.0 – 12.0					
SPET 120408S SPET 1204ADSN					

SPEW 12EN

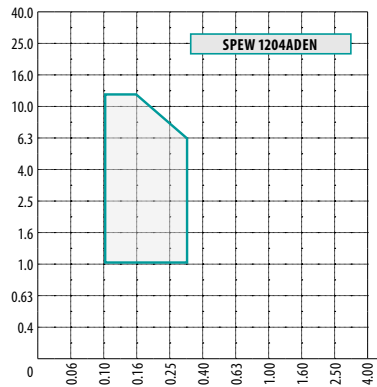

P	M	K	N	S	H
■	■	■	■	■	■
f 0.10 – 0.35					
a _p 1.0 – 12.0					
SPEW 1204ADEN					

SPEW 12SN

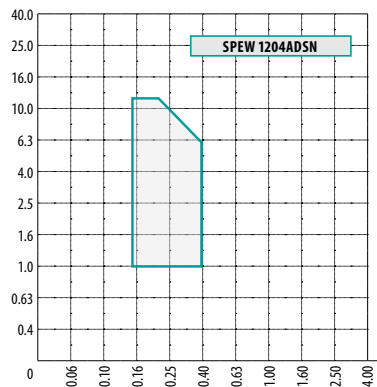
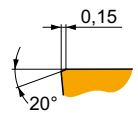

P	M	K	N	S	H
■	■	■	■	■	■
f 0.15 – 0.40					
a _p 1.0 – 12.0					
SPEW 1204ADSN					

SPGN

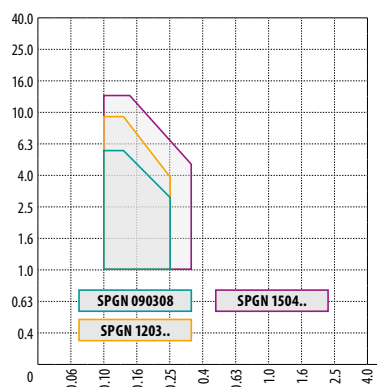

P	M	K	N	S	H
■	■	■	■	■	■
f 0.10 – 0.35 (according to insert size)					
a _p 0.5 – 13.5 (according to insert size)					
SPGN 090308 SPGN 1203.. SPGN 1504..					



CHOICE OF CUTTING INSERT

SPGN DZ

P	M	K	N	S	H
■	■	■	■	■	■
f	0.45 – 0.60				
a_p	2.0 – 18.0				

? SPGN 2506DZSR

SPKN EDSR(L)

SPKN 12	0.13
SPKN 15	0.16

P	M	K	N	S	H
■	■	■	■	■	■
f	0.15 – 0.40 (according to insert size)				
a_p	1.0 – 13.0 (according to insert size)				

**? SPKN 1203EDSR(L)
SPKN 1504EDSR(L)**

SPKN EDER(L)

P	M	K	N	S	H
■	■	■	■	■	■
f	0.10 – 0.35 (according to insert size)				
a_p	1.0 – 13.0 (according to insert size)				

**? SPKN 1203EDER(L)
SPKN 1504EDER(L)**

SPKR

SPKR 12	0.13
SPKR 15	0.25

P	M	K	N	S	H
■	■	■	■	■	■
f	0.15 – 0.45 (according to insert size)				
a_p	1.0 – 12.0 (according to insert size)				

**? SPKR 1203EDSR
SPKR 1504EDSR**



CHOICE OF CUTTING INSERT

SPKX

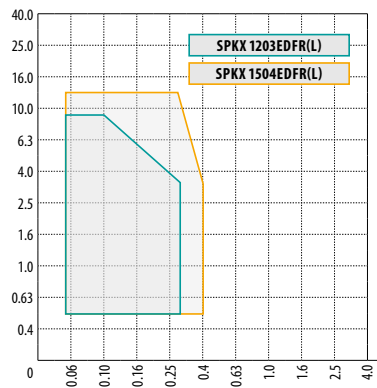

P	M	K	N	S	H
■	■	■	■	■	■
f 0.05 – 0.40 (according to insert size)					
a_p 0.5 – 13.0 (according to insert size)					
SPKX 1203EDFR(L) SPKX 1504EDFR(L)					

SPUN

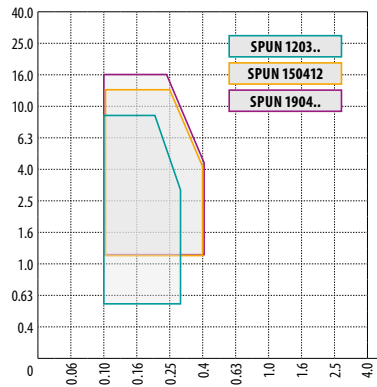

P	M	K	N	S	H
■	■	■	■	■	■
f 0.10 – 0.40 (according to insert size)					
a_p 0.5 – 16.0 (according to insert size)					
SPUN 1203.. SPUN 150412 SPUN 1904..					

SPUN 25

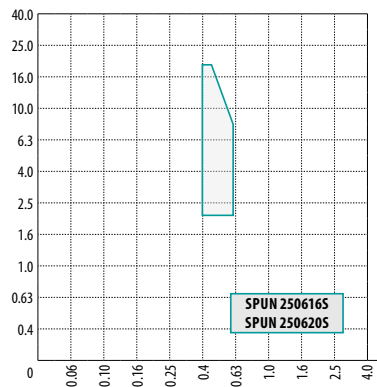
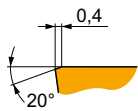

P	M	K	N	S	H
■	■	■	■	■	■
f 0.4 – 0.6					
a_p 2.0 – 18.0					
SPUN 250616S SPUN 250620S					

TBMR 27

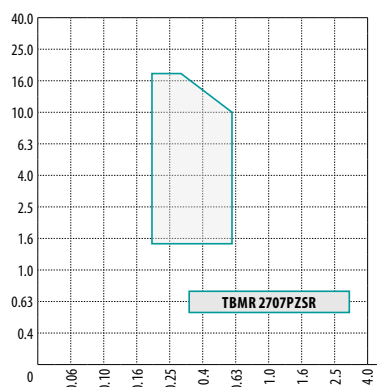
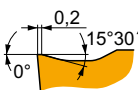

P	M	K	N	S	H
■	■	■	■	■	■
f 0.20 – 0.60					
a_p 1.5 – 18.0					
TBMR 2707PZSR					

CHOICE OF CUTTING INSERT

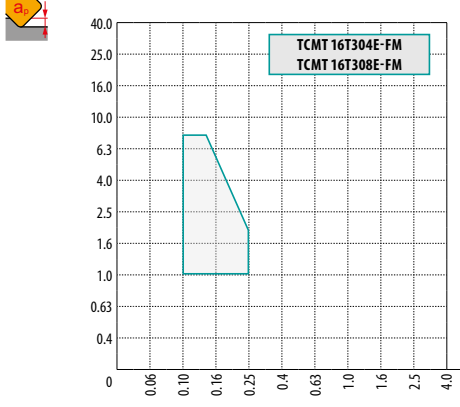

TCMT 16-FM

P	M	K	N	S	H
■	■	▣	■	■	■

f 0.10 – 0.25

a_p 1.0 – 8.5

? TCMT 16T304E-FM
TCMT 16T308E-FM

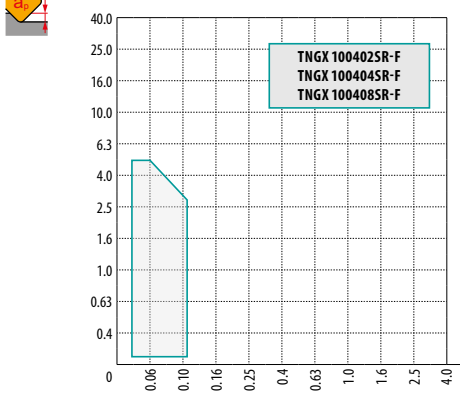

TNGX 10-F

P	M	K	N	S	H
■	▣	▣	■	■	■

f 0.3 – 0.11

a_p 0.1 – 5.0

? TNGX 100402SR-F
TNGX 100404SR-F
TNGX 100408SR-F

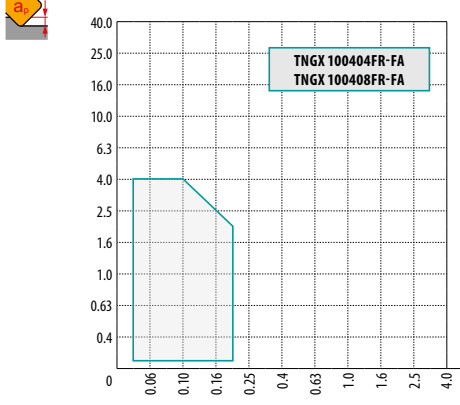

TNGX 10-FA

P	M	K	N	S	H
■	■	■	■	■	■

f 0.03 – 0.20

a_p 0.1 – 4.0

? TNGX 100404FR-FA
TNGX 100408FR-FA

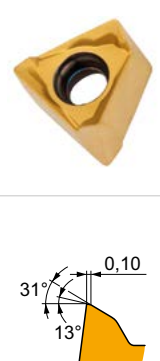
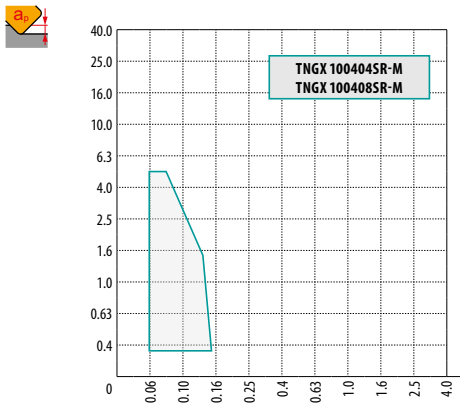

TNGX 10-M

P	M	K	N	S	H
■	▣	▣	■	▣	■

f 0.05 – 0.15

a_p 0.3 – 5.0

? TNGX 100404SR-M
TNGX 100408SR-M



CHOICE OF CUTTING INSERT

TNGX 16-F

P	M	K	N	S	H
■	■	■			
f	0.05 – 0.15				
a_p	0.2 – 10.0				

**? TNGX160604SR-F
TNGX160608SR-F**

TNGX 16-FA

P	M	K	N	S	H
■			■		
f	0.03 – 0.36				
a_p	0.2 – 9.0				

**? TNGX 160604FR-FA
TNGX 160608FR-FA**

TNGX 16-M

P	M	K	N	S	H
■	■	■		■	
f	0.12 – 0.28				
a_p	0.3 – 10.0				

**? TNGX 160604SR-M, TNGX 160608SR-M
TNGX 160612SR-M, TNGX 160616SR-M**

TNJV 12



P	M	K	N	S	H
■	■	■			
f	0.10 – 0.40				
a_p	2.0 – 6.0				

? TNJV 1204ANEN

CHOICE OF CUTTING INSERT

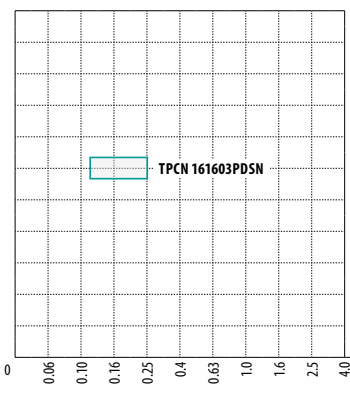

TPCN 16

P	M	K	N	S	H
■	■	■	■	■	■
f 0.12 – 0.25					
a _p –					
					
					
 TPCN 161603PDSN					

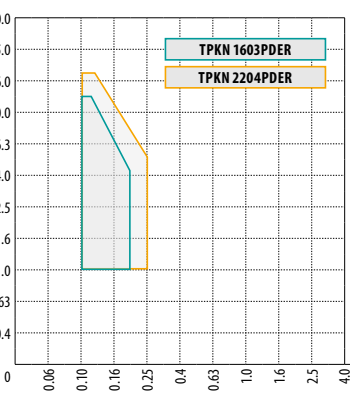

TPKN ER

P	M	K	N	S	H
■	■	■	■	■	■
f 0.10 – 0.25 (according to insert size)					
a _p 1.0 – 17.0 (according to insert size)					
					
					
 TPKN 1603PDER TPKN 2204PDER					

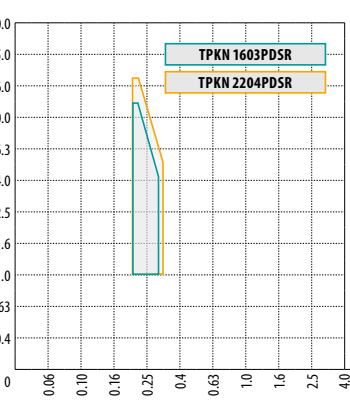

TPKN SR

P	M	K	N	S	H
■	■	■	■	■	■
f 0.20 – 0.35 (according to insert size)					
a _p 1.0 – 17.0 (according to insert size)					
					
					
 TPKN 1603PDSR TPKN 2204PDSR					

TPKR

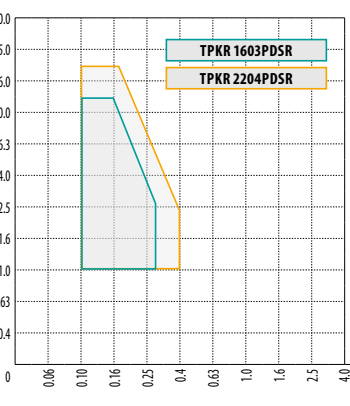



P	M	K	N	S	H
■	■	■	■	■	■
f 0.10 – 0.40 (according to insert size)					
a _p 1.0 – 17.0 (according to insert size)					
					
					
 TPKR 1603PDSR TPKR 2204PDSR					

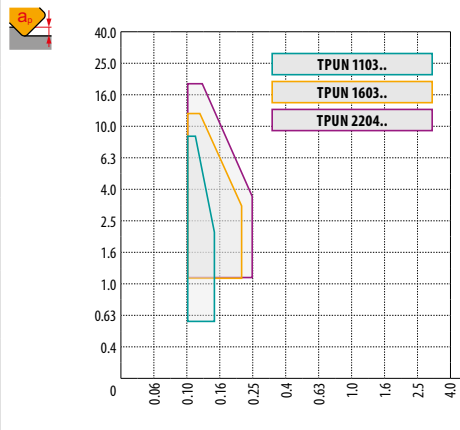

CHOICE OF CUTTING INSERT

TPUN



P	M	K	N	S	H
■		■			
f	0.10 – 0.25 (according to insert size)				
a_p	0.5 – 17.0 (according to insert size)				

TPUN 1103..
TPUN 1603..
TPUN 2204..

VCGT 22-FA

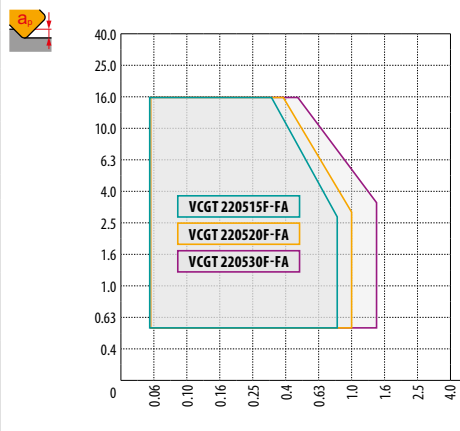

P	M	K	N	S	H
			■		
f	0.05 – 1.5 (according to insert size)				
a_p	0.5 – 16.0				

VCGT 220515F-FA
VCGT 220520F-FA
VCGT 220530F-FA

WNHX 04-WM

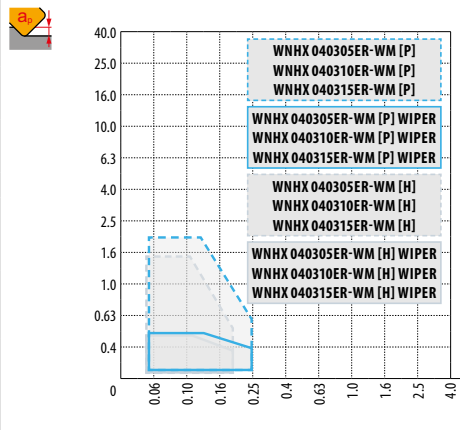

P	M	K	N	S	H
■		■			■
f	0.05 – 0.25				
a_p	0.1 – 2.0				

WNHX 0403..ER-WM

XDHW EN

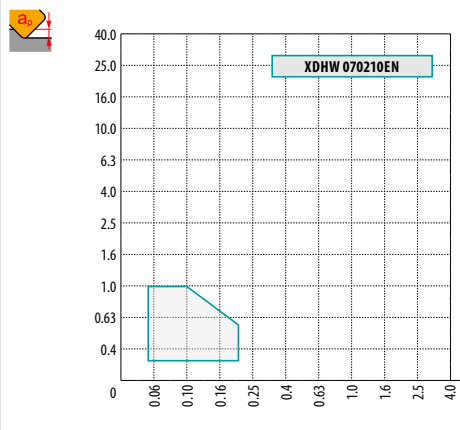









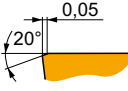
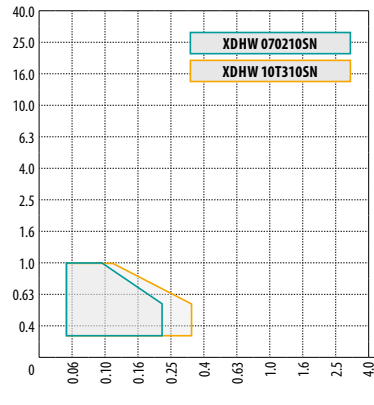















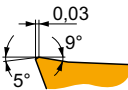
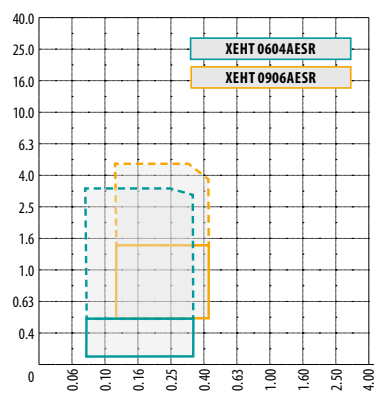















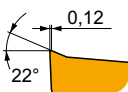
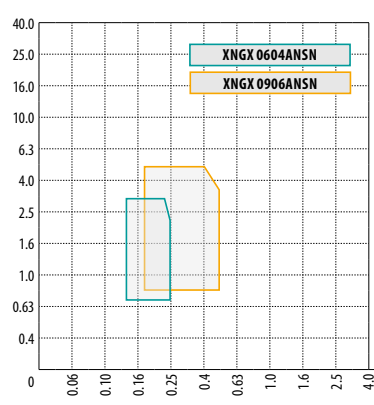

















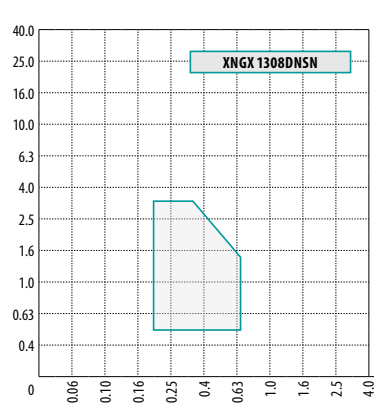







P	M	K	N	S	H
■		■			■
f	0.05 – 0.20				
a_p	0.2 – 1.0				

XDHW 070210EN



CHOICE OF CUTTING INSERT

<p>XDHW SN</p>	 		<table border="1"> <thead> <tr> <th>P</th> <th>M</th> <th>K</th> <th>N</th> <th>S</th> <th>H</th> </tr> </thead> <tbody> <tr> <td>■</td> <td>■</td> <td>■</td> <td>■</td> <td>■</td> <td>■</td> </tr> <tr> <td colspan="6"> f  0.05 – 0.35 (according to insert size) </td> </tr> <tr> <td colspan="6"> a_p  0.2 – 1.0 </td> </tr> <tr> <td colspan="6" style="text-align: center;">  </td> </tr> <tr> <td colspan="6" style="text-align: center;">  </td> </tr> <tr> <td colspan="6">  XDHW 070210SN XDHW 10T310SN </td> </tr> </tbody> </table>	P	M	K	N	S	H	■	■	■	■	■	■	f  0.05 – 0.35 (according to insert size)						a_p  0.2 – 1.0																		 XDHW 070210SN XDHW 10T310SN					
P	M	K	N	S	H																																								
■	■	■	■	■	■																																								
f  0.05 – 0.35 (according to insert size)																																													
a_p  0.2 – 1.0																																													
																																													
																																													
 XDHW 070210SN XDHW 10T310SN																																													
<p>XEHT</p>	 		<table border="1"> <thead> <tr> <th>P</th> <th>M</th> <th>K</th> <th>N</th> <th>S</th> <th>H</th> </tr> </thead> <tbody> <tr> <td>■</td> <td>■</td> <td>■</td> <td>■</td> <td>■</td> <td>■</td> </tr> <tr> <td colspan="6"> f  0.08 – 0.45 (according to insert size) </td> </tr> <tr> <td colspan="6"> a_p  0.1 – 5.0 (according to insert size) </td> </tr> <tr> <td colspan="6" style="text-align: center;">  </td> </tr> <tr> <td colspan="6" style="text-align: center;">  </td> </tr> <tr> <td colspan="6">  XEHT 0604AESR XEHT 0906AESR </td> </tr> </tbody> </table>	P	M	K	N	S	H	■	■	■	■	■	■	f  0.08 – 0.45 (according to insert size)						a_p  0.1 – 5.0 (according to insert size)																		 XEHT 0604AESR XEHT 0906AESR					
P	M	K	N	S	H																																								
■	■	■	■	■	■																																								
f  0.08 – 0.45 (according to insert size)																																													
a_p  0.1 – 5.0 (according to insert size)																																													
																																													
																																													
 XEHT 0604AESR XEHT 0906AESR																																													
<p>XNGX ANSN</p>	 		<table border="1"> <thead> <tr> <th>P</th> <th>M</th> <th>K</th> <th>N</th> <th>S</th> <th>H</th> </tr> </thead> <tbody> <tr> <td>■</td> <td>■</td> <td>■</td> <td>■</td> <td>■</td> <td>■</td> </tr> <tr> <td colspan="6"> f  0.13 – 0.50 (according to insert size) </td> </tr> <tr> <td colspan="6"> a_p  0.7 – 5.0 (according to insert size) </td> </tr> <tr> <td colspan="6" style="text-align: center;">  </td> </tr> <tr> <td colspan="6" style="text-align: center;">  </td> </tr> <tr> <td colspan="6">  XNGX 0604ANSN XNGX 0906ANSN </td> </tr> </tbody> </table>	P	M	K	N	S	H	■	■	■	■	■	■	f  0.13 – 0.50 (according to insert size)						a_p  0.7 – 5.0 (according to insert size)																		 XNGX 0604ANSN XNGX 0906ANSN					
P	M	K	N	S	H																																								
■	■	■	■	■	■																																								
f  0.13 – 0.50 (according to insert size)																																													
a_p  0.7 – 5.0 (according to insert size)																																													
																																													
																																													
 XNGX 0604ANSN XNGX 0906ANSN																																													
<p>XNGX 13</p>	 		<table border="1"> <thead> <tr> <th>P</th> <th>M</th> <th>K</th> <th>N</th> <th>S</th> <th>H</th> </tr> </thead> <tbody> <tr> <td>■</td> <td>■</td> <td>■</td> <td>■</td> <td>■</td> <td>■</td> </tr> <tr> <td colspan="6"> f  0.25 – 0.70 </td> </tr> <tr> <td colspan="6"> a_p  0.5 – 3.5 </td> </tr> <tr> <td colspan="6" style="text-align: center;">  </td> </tr> <tr> <td colspan="6" style="text-align: center;">  </td> </tr> <tr> <td colspan="6">  XNGX 1308DNSN </td> </tr> </tbody> </table>	P	M	K	N	S	H	■	■	■	■	■	■	f  0.25 – 0.70						a_p  0.5 – 3.5																		 XNGX 1308DNSN					
P	M	K	N	S	H																																								
■	■	■	■	■	■																																								
f  0.25 – 0.70																																													
a_p  0.5 – 3.5																																													
																																													
																																													
 XNGX 1308DNSN																																													

CHOICE OF CUTTING INSERT

XNHQ TN

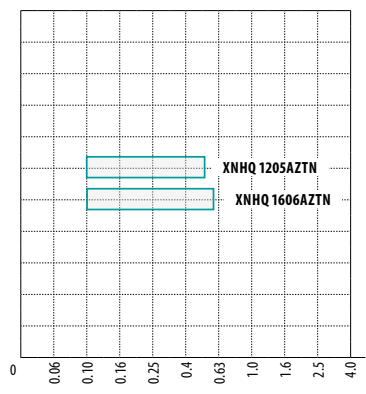
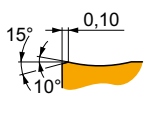
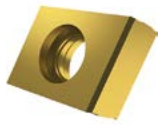

P	M	K	N	S	H
■	■	■	■	■	■
f 0.10 – 0.60 (according to insert size)					
a _p -					
? XNHQ 1205AZTN XNHQ 1606AZTN					

XP ER-FM

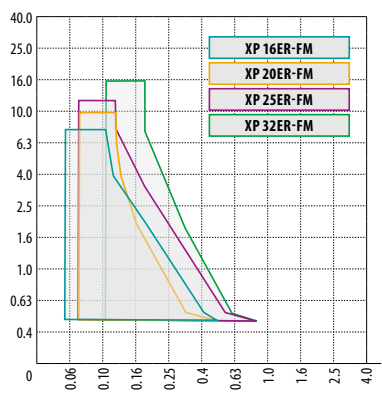

P	M	K	N	S	H
■	■	■	■	■	■
f 0.05 – 0.25 (according to insert size)					
a _p 0.3 – 16.0 (according to insert size)					
? XP 16ER-FM, XP 20ER-FM XP 25ER-FM, XP 32ER-FM					

XPHT 16E

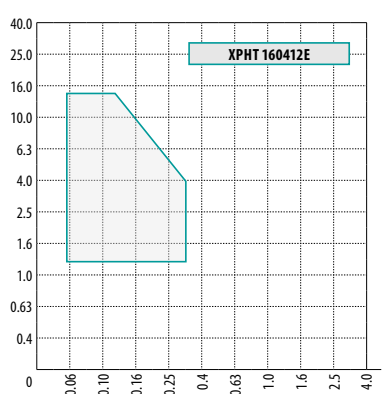
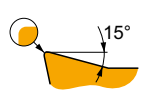

P	M	K	N	S	H
■	■	■	■	■	■
f 0.05 – 0.30					
a _p 1.2 – 15.0					
? XPHT 160412E					

XPHT 16-FA

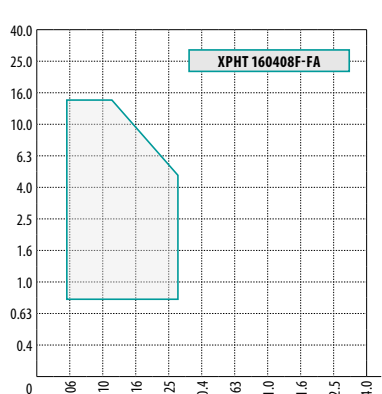
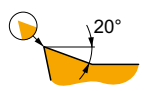

P	M	K	N	S	H
■	■	■	■	■	■
f 0.05 – 0.30					
a _p 0.8 – 15.0					
? XPHT 160408F-FA					

CHOICE OF CUTTING INSERT

XPHT 16S

P	M	K	N	S	H
■	■	▣	■	■	■
f	0.05 – 0.30				
a_p	1.2 – 15.0				

? XPHT 160412S

ZDCW 07

P	M	K	N	S	H
▣	■	■	■	■	■
f	0.15 – 1.50				
a_p	0.3 – 1.0				

? ZDCW 070304

ZDCW 09

P	M	K	N	S	H
▣	■	■	■	■	■
f	0.30 – 2.00				
a_p	0.3 – 1.0				

? ZDCW 09T304

ZDEW 12

P	M	K	N	S	H
▣	■	■	■	■	■
f	0.50 – 3.00				
a_p	0.3 – 1.6				

? ZDEW 120408



CHOICE OF CUTTING INSERT

ZPER-F

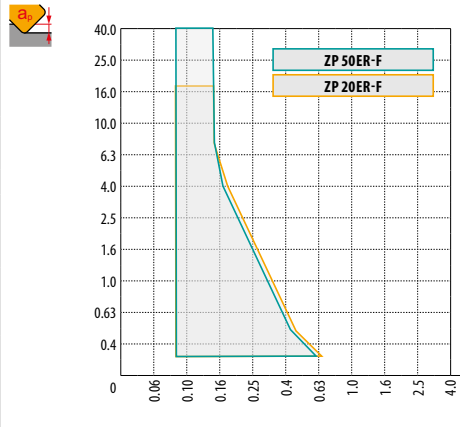
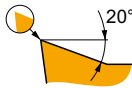

P	M	K	N	S	H
■	■	■	■	■	■
f	0.04 – 0.18 (according to insert size)				
a_p	0.3 – 44.7 (according to insert size)				
ZP 50ER-F ZP 20ER-F					

ZPER-FM

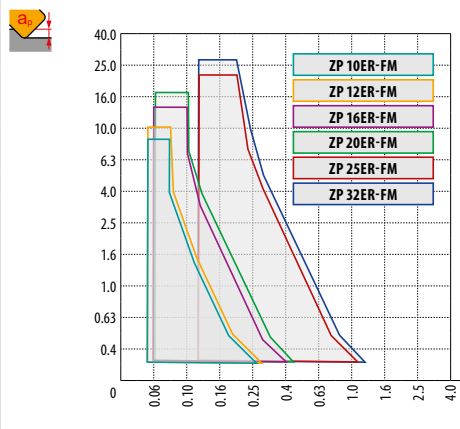

P	M	K	N	S	H
■	■	■	■	■	■
f	0.05 – 0.21 (according to insert size)				
a_p	0.3 – 28.6 (according to insert size)				
ZP 10ER-FM, ZP 12ER-FM ZP 16ER-FM, ZP 20ER-FM ZP 25ER-FM, ZP 32ER-FM					

ZPER-M

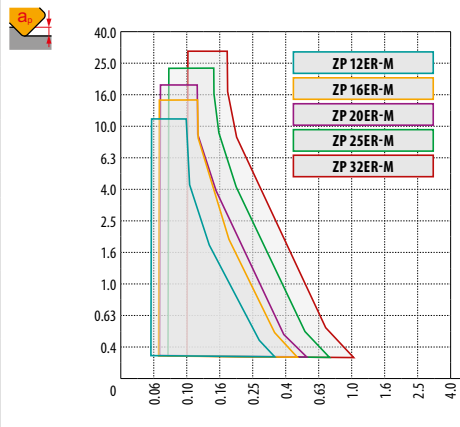
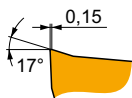

P	M	K	N	S	H
■	■	■	■	■	■
f	0.06 – 0.25 (according to insert size)				
a_p	0.3 – 28.6 (according to insert size)				
ZP 12ER-M, ZP 16ER-M ZP 20ER-M, ZP 25ER-M, ZP 32ER-M					

ZPER-R

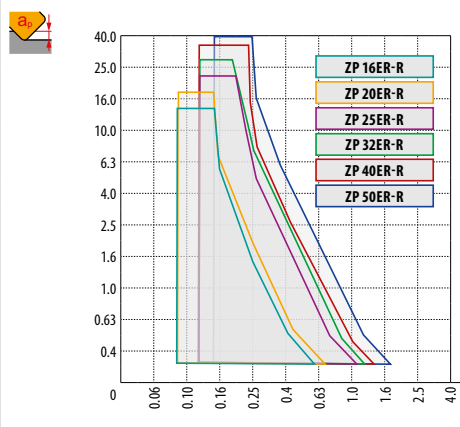
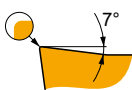

P	M	K	N	S	H
■	■	■	■	■	■
f	0.09 – 0.33 (according to insert size)				
a_p	0.3 – 44.7 (according to insert size)				
ZP 16ER-R, ZP 20ER-R ZP 25ER-R, ZP 32ER-R ZP 40ER-R, ZP 50ER-R					

MILLING GRADES – OVERVIEW

Marking of grades

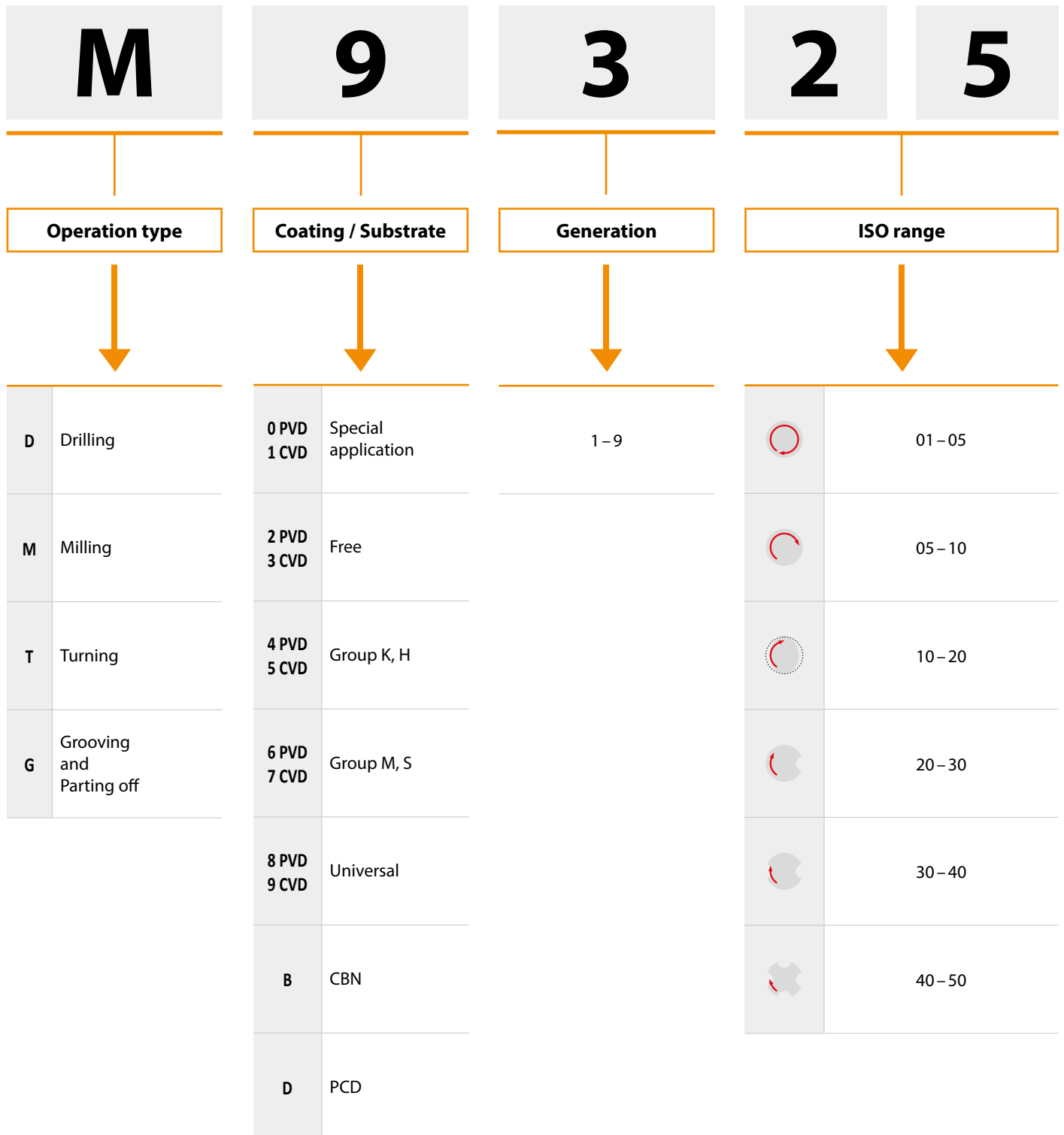



MILLING GRADES – OVERVIEW

Grade Identification	Area of Application	Application	Feed	Cutting speed	Resistance to adverse Working Conditions	Coating	Colour	Substrate	Coolant benefit	Grade description
M9315	P05 – P25	■				MT-CVD	█	H	---	Milling grade with high abrasion resistance even at high thermal loads, main application area is higher cutting speeds with medium or small depths of cut.
	K10 – K30	■	▴	▴	▴					
	H10 – H20	▣								
M9325	P10 – P30	■				MT-CVD	█	H	---	This grade has an ideal balance between wear resistance and toughness, it is mainly designed for roughing operations. Advantages are excellent wear resistance even at relatively high cutting speeds with excellent reliability, this grade is more suitable for applications using higher speeds and lower feed rates.
	K10 – K30	■	▴	▴	▴					
	H15 – H20	▣								
M9340	P35 – P50	■				MT-CVD	█	H	---	A very tough grade, where the main advantage is the high strength of the cutting edge and resistance to adverse cutting conditions. Although this material has an MT-CVD M30 – M40 coating, it is possible to use emulsion cooling for its application, especially in optimum cutting conditions.
	M30 – M40	■	▴	▴	▴					
	S15 – S20	■								
M5315	P05 – P20	▣				MT-CVD	█	H	---	One of the most abrasion-resistant milling grades which should be used under stable conditions. Its main advantage is the extremely high resistance to thermal stress and abrasive K05 – K25 wear. It is mainly used for machining hard and very hard materials, particularly cast iron.
	K05 – K25	■	▴	▴	▴					
	H05 – H20	■								
M8310	P01 – P10	■				PVD	█	ultra submicron H	-	Grade specially developed for copy milling, featuring high resistance to abrasion. It is suitable for machining at higher cutting speeds under stable cutting conditions, and for machining virtually all groups of machined materials (particularly stronger and harder materials).
	M01 – M10	▣	▴	▴	▴					
	K01 – K10	■								
	H05 – H15	▣								
8215	P10 – P20	■				PVD	█	submicron H	+ / -	One of the most versatile milling grades, in terms of both the range of workpiece materials and the range of possible applications. It is characterised by high wear resistance and operational reliability. Its other advantages include excellent resistance to cracking induced by temperature shock. With its unique properties, this material is undoubtedly one of the pillars of the milling range.
	M10 – M20	▣	▴	▴	▴					
	K10 – K25	■								
	N10 – N25	■								
	S10 – S15	▣								
M8325	P20 – P40	■				PVD	█	S	-	The main application area of this grade is machining all kinds of steels (including stainless) in the "soft state". It can also be used for machining softer cast irons. Suitable for M15 – M30 machining at medium speeds under average cutting conditions.
	M15 – M30	▣	▴	▴	▴					
M8330	P20 – P40	■				PVD	█	submicron H	+ / -	This grade is universal and can be used for machining various types of materials. However, it's priority application area lies within steels and ductile cast irons. It is recommended for milling at medium speeds under unstable cutting conditions.
	M20 – M35	■	▴	▴	▴					
	K20 – K40	■								
	N15 – N30	▣								
	S15 – S25	▣								
M8340	P25 – P50	■				PVD	█	submicron H	+ / -	Grade specially developed for copy milling, featuring high resistance to abrasion. It is suitable for machining at higher cutting speeds under stable cutting conditions, and for machining virtually all groups of machined materials (particularly stronger and harder materials).
	M20 – M40	■	▴	▴	▴					
	K20 – K40	▣								
	S20 – S30	■								



MILLING GRADES – OVERVIEW

Grade Identification	Area of Application	Application	Feed	Cutting speed	Resistance to adverse Working Conditions	Coating	Colour	Substrate	Coolant benefit	Grade description
M8345	P30 – P50	■				PVD	Dark Purple	H	-	This grade has exceptional operational reliability and is designed for heavy cuts in unfavourable conditions in difficult and tough materials.
	M30 – M40	■								
M6330	P20 – P35	■				PVD	Yellow	H	+ / -	Milling grade with extraordinary service reliability. Especially suitable for machining of hard to machine materials. Powerful in applications where unfavourable conditions and heavy cuts dominate.
	M20 – M35	■								
	S20 – S30	■								
M4303	P01 – P10	☑				PVD	Dark Purple	ultra submicron H	-	The most wear resistant grade for mold & die applications. Offers exceptional performance at high cutting speeds and low feeds in stable cutting conditions. Suitable for finishing operations in difficult workpiece materials.
	K01 – K10	■								
	N01 – N10	☑								
	H01 – H10	■								
M4310	P05 – P15	☑				PVD	Dark Purple	ultra submicron H	-	Universal grade for mold & die applications. Suitable for finishing as well as semi-roughing operations. This grade combines high wear resistance with extraordinary operational reliability.
	M05 – M15	☑								
	K05 – K15	■								
	S05 – S10	■								
	H05 – H15	■								
2003	P01 – P10	☑				PVD	Dark Purple	ultra submicron H	-	Milling grade with excellent wear resistance. Most suitable in a machining of hard and high strength materials under stable cutting conditions and moderate/higher cutting speeds. Suitable for cutting other workpiece group materials except non-ferrous metals.
	M01 – M10	☑								
	K01 – K10	■								
	S05 – S10	■								
M0315	N05 – N25	■				PVD	Grey	submicron H	-	Submicron grade for milling non-ferrous metals and their alloys with a balanced ratio of wear resistance and toughness. It is provided with a unique coating with excellent friction properties.
M8326	P20 – P40	■				PVD	Dark Purple	H	-	Special grade for heavy duty. The main application area of this grade is machining all kinds of steels (including stainless) in the „soft state“. It can also be used for machining softer cast irons. Suitable for M15 – M30 machining at medium speeds under average cutting conditions.
	M15 – M30	☑								
M8346	P30 – P50	■				PVD	Dark Purple	H	-	Special grade for heavy duty. This grade has exceptional operational reliability and is designed for heavy cuts in unfavourable conditions in difficult and tough materials.
	M30 – M40	■								
S26	P15 – P30	■				-	Grey	S	++	Uncoated milling grade with excellent resistance to erosion of the cutting face. It is intended solely for machining carbon and alloy steels at low cutting speeds.
S45	P30 – P45	■				-	Grey	S	++	Uncoated, tough cutting grade suitable for machining applications where low cutting speed and unfavourable cutting conditions dominate
HF7	M10 – M20	☑				-	Dark Purple	submicron H	++	Uncoated grade which is primarily designed for machining non-ferrous metals; can also be used for other machined materials (except steel). This grade can be used in turning, milling, and even boring.
	K10 – K25	■								
	N10 – N25	■								



MILLING GRADES – OVERVIEW

Substrate

H	WC-Co based substrate
submicron H	WC-Co based substrate, fine-grained (< 1 µm)
ultra submicron H	WC-Co based substrate, very fine-grained (< 0.5 µm)
S	Substrate with cubic carbides

Coating

MT-CVD	Medium-temperature chemical method of coating
PVD	Low-temperature physical method of coating
×	Uncoated grade

Coolant Benefit

---	Very negative effect on tool life – cooling is not recommended
-	Slightly negative effect on tool life
+ / -	Influence of cooling may be both positive and negative – decisive factor is specific working conditions
++	Positive effect on tool life – cooling is recommended

Attribute Strength



Level 1–5



WORKING CONDITION WHEN MILLING

When performing a milling operation, the edge of the milling cutter almost always makes interrupted (intermittent) cuts. Each edge enters and exits the workpiece at least once within a single revolution of the tool.

In addition, a periodic change in chip thickness takes place during each revolution of the milling cutter. This results in fluctuations in the size and direction of the tangential component of the cutting force. The edge of the milling cutter is thus subjected to cyclic stress which results in specific wear. The durability of the milling cutter edge is therefore dependent on the conditions in which the edge enters and exits the workpiece. Proper choice of these conditions significantly affects the milling process and its results in terms of cutting power and quality of the machined surface. At the moment the edge enters or exits the workpiece, the edge is subjected to more or less intense mechanical shock which causes mechanical stress in the immediate vicinity of the cutting edge.

If engagement conditions are chosen incorrectly, this shock can cause brittle damage to the edge, in the form of either fracturing or crumbling of the edge.

Position of the milling cutter relative to the workpiece is thus a very important factor. There are essentially three possible milling cutter positions: side up milling, centre milling and side down milling. For indexable tools, we recommend using co-directional engagement (so that the cutter forms thick chips on entry and thin chips on exit). **However**, there are notable exceptions (workpieces with surface skin, machines with worn feed screws...).

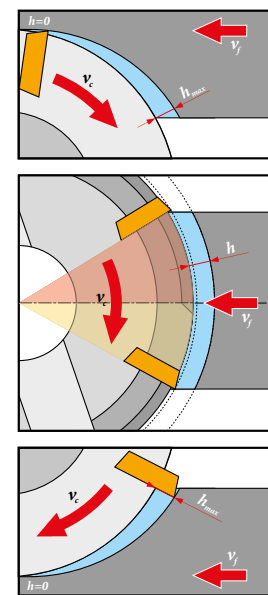
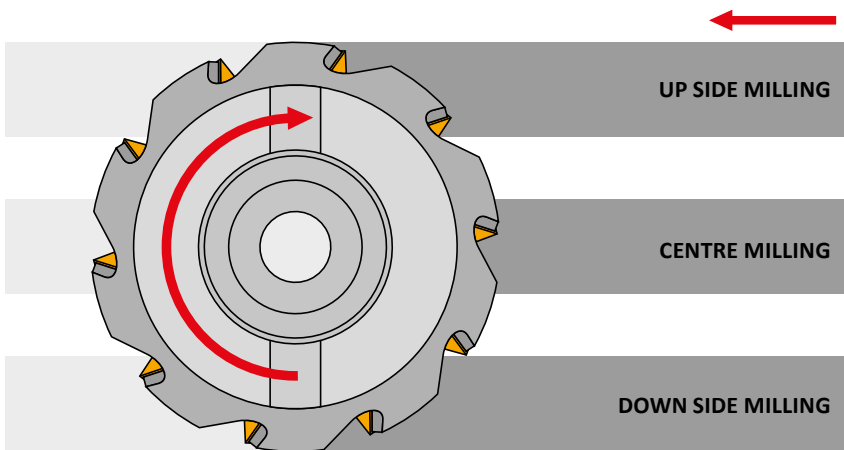

During face milling, where the width of the milled surface a_e is equal to the diameter of the milling cutter, follow the values recommended specifically for the inserts. If the engagement width is less than the diameter of the milling cutter, then the key factor is whether we machine with the centre or the side of the milling cutter, as mentioned above. In both cases, corrections in feed and cutting speed should be

made (see correction tables on page 699). Either way, we should try to ensure that the tool does not enter or exit the cut in an area close to the centre of the milling cutter (so-called dead zone).

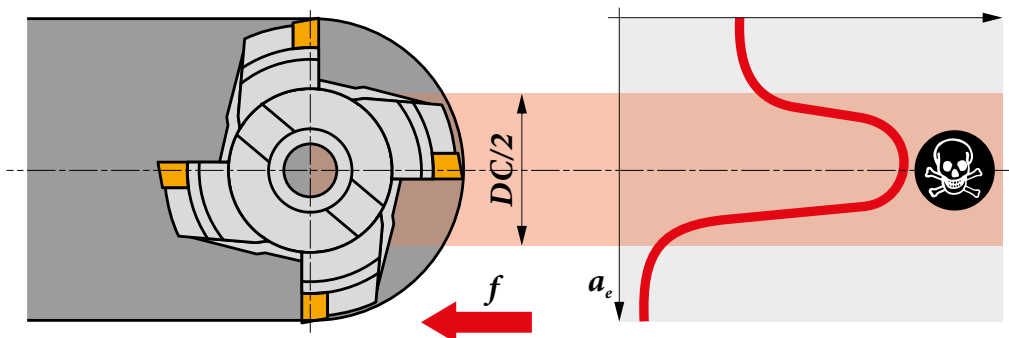

When the edge exits from the cut, this is accompanied by both stressing of the edge due to rapid cooling of the surface layers of the insert near the cutting edge and by mechanical shock caused by the release

of flexible deformations, particularly in the surface layers of the workpiece after a rapid decrease in cutting force.

WORKING CONDITION WHEN MILLING

As stated above, chip thickness h changes during a single revolution depending on the angle φ in line with the formula $h\varphi = f_z \times \sin\varphi$. Maximum chip thickness with steady f_z is reached within the axis of the milling cutter. The average thickness of a chip (h_m) removed by one tooth during one revolution is calculated as the height of a rectangle with the same area as the area under a sine curve relative to the radial depth of cut a_e . Average chip

thickness h_m is dependent on the type of milling cutter and on engagement conditions, particularly the ratio of a_e/DC , feed per tooth f_z and naturally also on the entering angle $KAPR - \kappa_r$. The following figure shows illustrative examples.

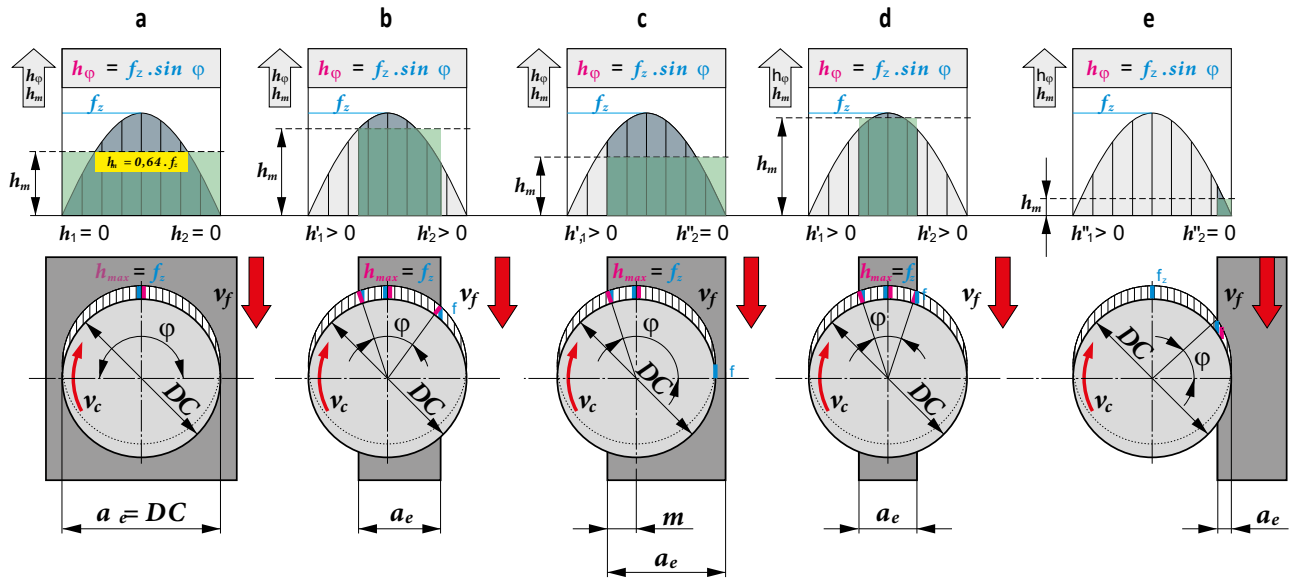

Average chip thickness h_m for milling (with the centre) in accordance with figure a, b, d is calculated based on the formula:

$$h_m = f_z \cdot \sin \kappa_r \left(\frac{57.3 \cdot a_e}{DC \cdot \arcsin \left(\frac{a_e}{DC} \right)} \right)$$

Average chip thickness h_m for machining with the side of the milling cutter (figure c, e) is calculated based on the formula:

$$h_m = f_z \cdot \sin \kappa_r \cdot 114.6 \cdot \left(\frac{a_e}{DC \cdot \arccos \left(1 - \frac{2a_e}{DC} \right)} \right)$$

For milling with the side of the cutter in line with figure e, where the a_e/DC ratio is very low (< 0.2), average chip thickness h_m can be calculated using the simplified formula:

$$h_m = f_z \sin \kappa_r \sqrt{\frac{a_e}{DC}}$$

Where:

- h_m Is average chip thickness [mm]
- f_z Feed per tooth [mm/tooth]
- a_e Radial depth of cut [mm]
- DC Diameter of the milling cutter [mm]
- κ_r Entering angle of the main cutting edge (KAPR) [°]



WORKING CONDITION WHEN MILLING

For optimal application of any milling tool, we recommend checking chip thickness, or rather, using the recommended h_m range to choose (calculate) the proper feed rate.

It is, of course, also necessary to take into account the geometry of the indexable insert itself. To calculate f_z , you can use the formulae provided above or use the following formula. The values of coefficient c can be derived from the following chart:

$$f_z = \frac{h_m}{\sin \cdot \kappa_r} \cdot c$$

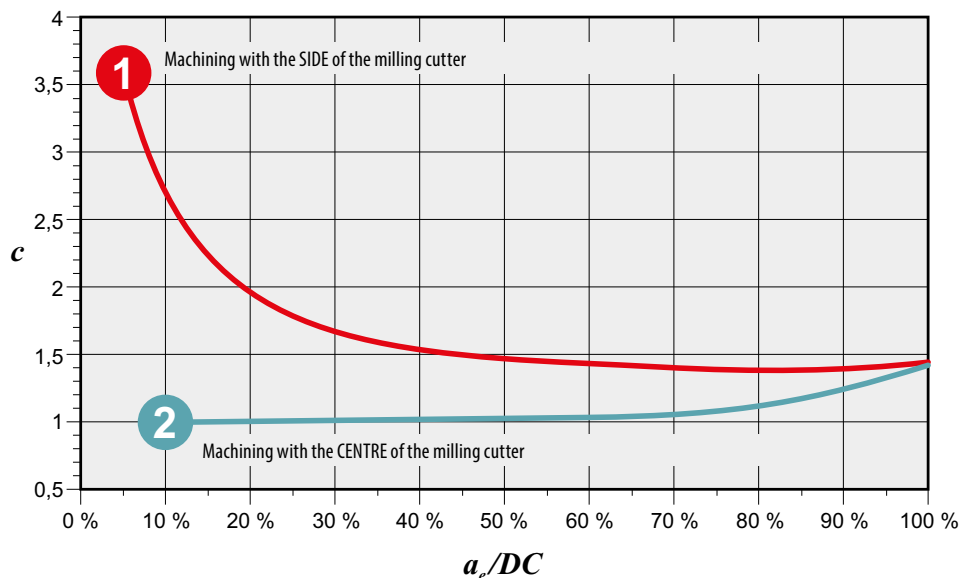

Each tool type listed in this catalogue has its own optimum range of average chip thickness. Using values lower than listed in this range may prevent the tool from cutting or, rather, may subject the insert to excessive wear and, in extreme cases, may even destroy it in the process. Similarly, exceeding the recommended values may destroy the insert by overloading the tool. The ranges of recommended average chip thickness are listed directly by each tool family.

The full range of chip thickness can only be used for groups P and K. The lower limit of chip thickness must be adjusted (taken as higher than listed) for groups M and S and for tougher materials from group N. The upper limit must be lowered for groups H, S and slightly also for tougher materials from group M. On the contrary, it is possible to increase the upper limit of recommended average chip thickness by approx. 10 – 15 % when machining soft materials from group N.

SHN06C

P

M

K

H

S

ECON HN06 45° Face Mill with Double Negative Design and Internal Coolant
 Highly productive 45° face mill utilising double sided HN...06 style inserts with APMX of 3 mm. Roughing, finishing and chamfering. Economical insert with 12 cutting edges. Differential tooth pitch. Weldon, modular and arbor style available in range from Ø25 up to Ø125 mm. Body treated for longer tool life.

KAPR	45°
APMX	3.0 mm

Optimum range of average chip thickness [mm]

	0.06 - 0.15
	0.06 - 0.15

Product

DC DCX OAL DCONMS DCCB LU LF TDZ KWW KWD GAMP GAMP

MACHINED SURFACE ROUGHNESS

One of the key criteria in finishing operations is the resulting roughness of the machined surface. The following article will therefore provide several tips on how to approach this issue.

Face Milling

When performing any milling operation, the machined surface is shaped by multiple edges. The microgeometry of the surface is thus dependent on the axial runout of the individual edges of the milling cutter. The most axially protruding edges are the ones that shape the machined surface. The resulting roughness of the milled surface is, to a large extent, influenced by the design of the tip of the indexable insert. If the tip of the indexable insert has a radius, it creates imperfections on the surface. The size of these imperfections is dependent on the corner radius and feed speed (fig.a). For inserts with smoothing

segments, the rule of thumb is that the feed per revolution must be less than 80 % of the size of the smoothing segment. In larger (multi-tooth) cutters, fulfilling this condition can sometimes be problematic, since the maximum feed value $f_z = 0.8 \cdot a/z$ may approach the lower limit recommended for certain types of insert geometry (the feed speed is lower than the width of the facet in the feed direction). Using lower feed speeds usually results in an increase in cutting resistance, leading to reduced tool life.

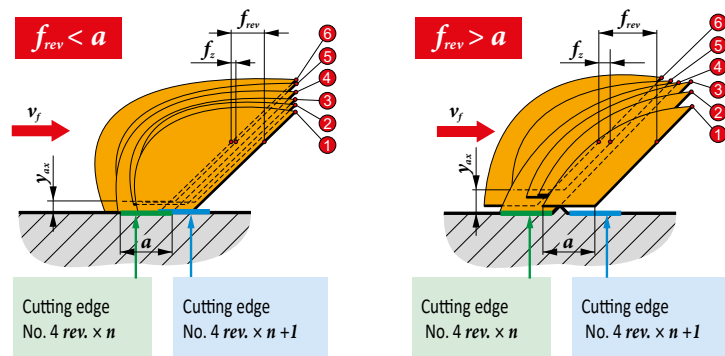
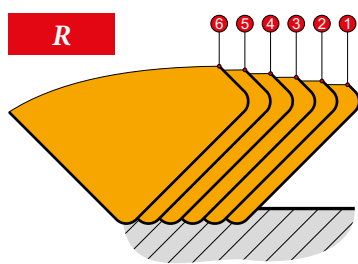

In that case, the best solution is to use a milling cutter with fewer teeth or to reduce the number of teeth on the milling cutter (only fitting an insert onto every other tooth of milling cutters with an even number of teeth). There is, however, a risk of reduced productivity. Another alternative is the use of so-called wiper inserts (if such inserts are available for the given type of tool). Even this solution has its drawbacks, however. For milling cutters with a small diameter (approx. 63 mm and less) the speed gradient is too high and there is a risk of tearing or smearing of the surface (edge build-up) towards the centre of the milling cutter when machining tough materials. Information about the size of smoothing segments can be found at the beginning of technical information in the catalogue section.

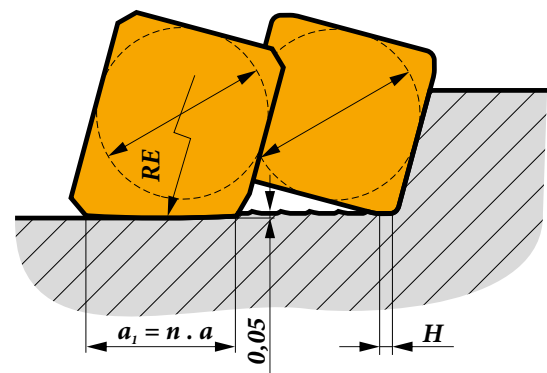

As regards the majority of other types of milling operations, the approximate maximum surface roughness can again be calculated. To do so, we can use the following formula, here accompanied by a graphical explanation.

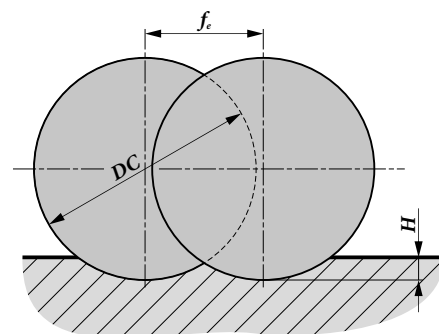

$$H = \frac{f_e^2}{4 \cdot DC} \rightarrow f_e = \sqrt{4 \cdot DC \cdot H}$$



MACHINED SURFACE ROUGHNESS

Where and when to apply this formula:

1) When determining line spacing during peripheral linear machining with toric* or ball-nose milling cutters.

* Substitute insert diameter for *INSD*.

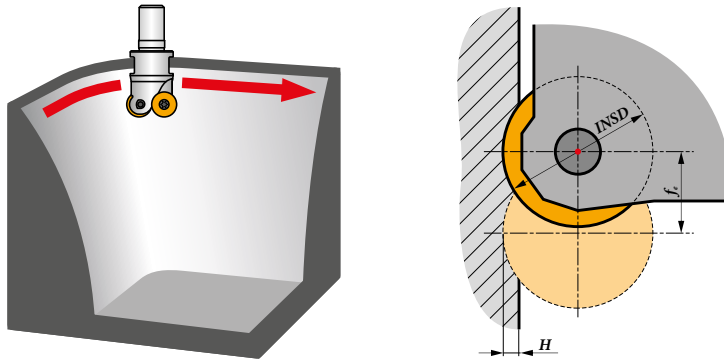

2) When determining line spacing during transverse linear machining with (not only) toric milling cutters and during plunge milling**.

** Substitute milling cutter diameter for *DC*.

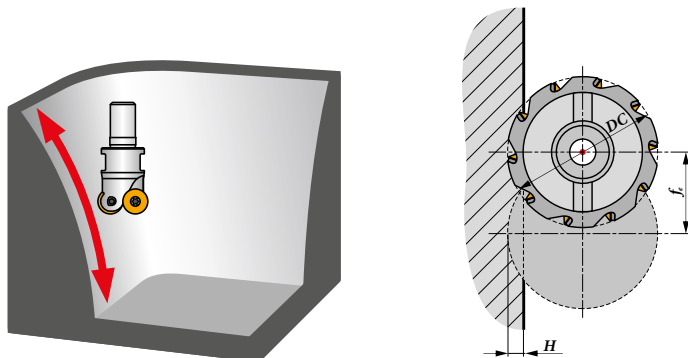

3) When determining feed per tooth during contour milling (side milling).***

*** Substitute milling cutter diameter for *DC* and divide by the number of teeth.

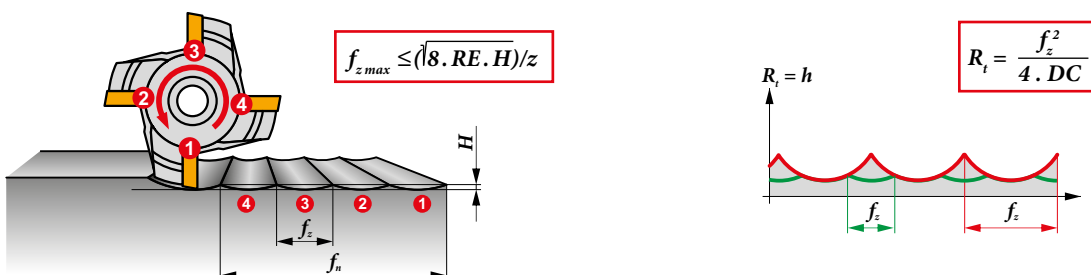



MACHINED SURFACE ROUGHNESS

Surface roughness in the radial direction, i.e. during side milling (contour or bottom of a slot milled with a disc milling cutter) is calculated using the following formula:

Substitute milling cutter diameter for DC .

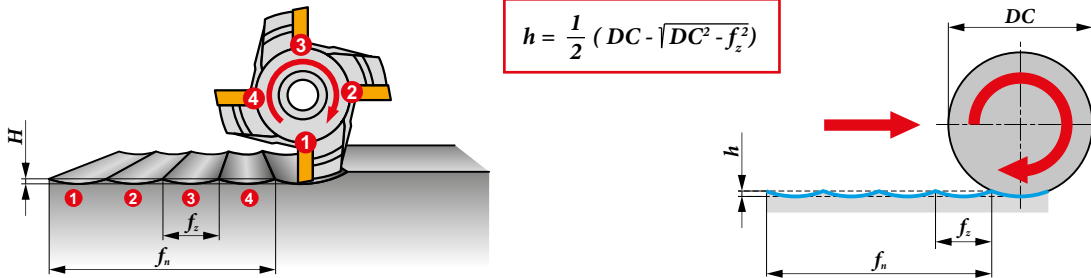

Plunge Milling (Slotting)

For this technology, you will find recommendations for the maximum permitted radial depth of cut for a given tool group. In this case, tool overhang L plays a vital role. It is therefore recommended to use a higher overhang ($L/DC > 4$) when creating wider recesses and to adjust engagement conditions in line with the following figures:

Contour milling

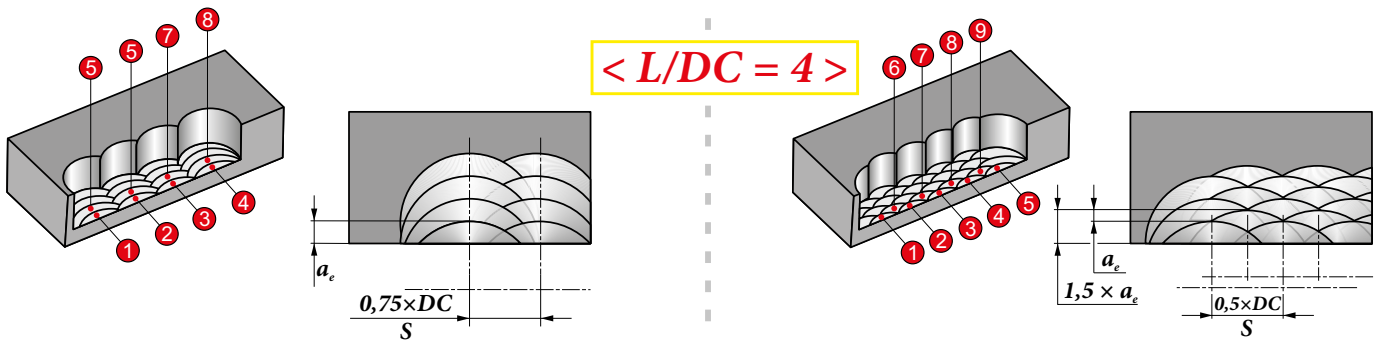

Slot milling

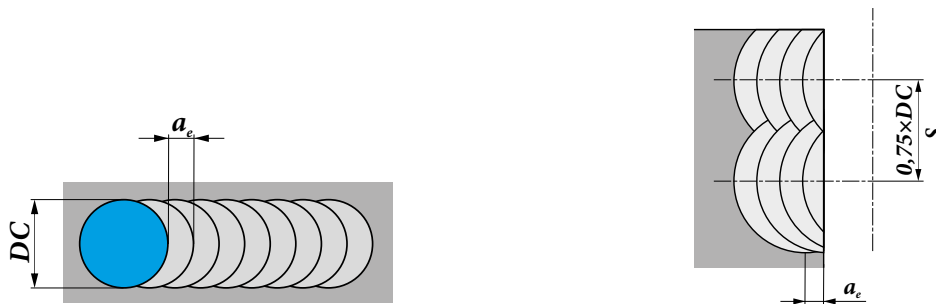

Shoulder milling

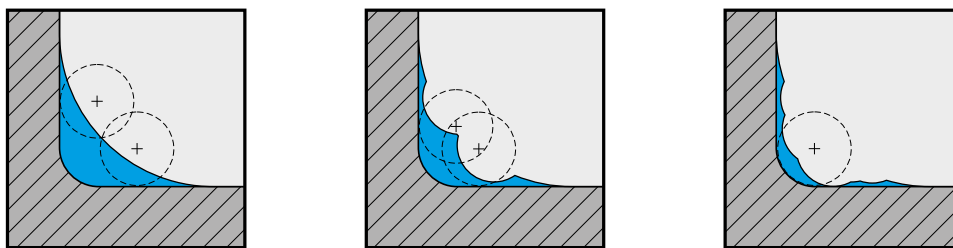

In shoulder milling, the mutual offset of paths should also not exceed $\frac{3}{4}$ of the milling cutter diameter (and should be gradually decreased towards the corner).

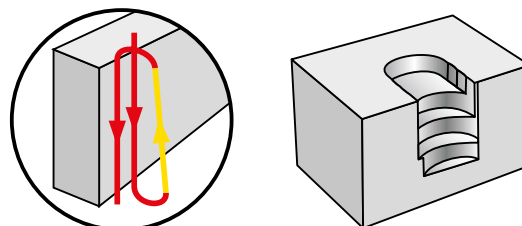

When creating programmes for this technology, you should avoid passes over already machined surfaces (bottom). In other words, we do not recommend using a so-called drilling cycle. When selecting engagement conditions, make sure that more than one tooth is engaged at all times. We also recommend gradually reducing the axial depth of cut (plunge depth), i.e. creating a "staircase" structure. Also keep in mind that plunge milling requires the use of lower speeds and feeds per tooth compared to traditional methods.

Ramping

Ramping is a technology that simultaneously applies three different cutting methods:

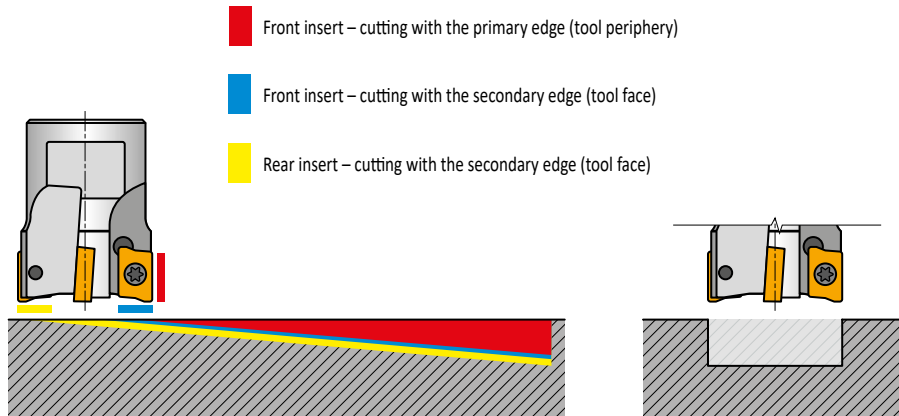

An important parameter here is the ramp angle, i.e. the descent in the Z axis across the given stretch. Some tools (HFC) allow descending at a lower angle but with a higher feed, or allow a higher ramp angle with lower feed to be used. These angles or descents across the given section are listed in technical recommendations.

	Down at max. angle and horizontally back and down again at max. angle and horizontally back...
	There and back at a smaller (half) angle and last exit horizontally.
	Down at max. angle, back horizontally by length D and then down at max. angle, repeat straight...
	Down at max. angle, then up by length X and down again at max. angle.
	$X = tg \alpha (DC - W1)$

When choosing the feed speed, we advise following the recommendation given for slot milling. If the slot is deeper (i.e. first pass at an angle, second to level off), you must select one of four basic programme variants for the consecutive steps.

Where:

- X** Offset [mm]
- α** Ramp angle [°]
- DC** Diameter of the milling cutter [mm]
- W1** Insert width [mm]

Milling using Circular or Helical Interpolation

This method is analogous to ramping, except it is performed along a circular path. In this case, one of the most important factors is the milling cutter diameter or minimum and maximum diameter of the hole we are able to machine with the given milling cutter type (this information is vital only when using milling cutters without central cutting edges). If the milling cutter diameter is too large, the path of the insert will not pass through the axis of the hole, resulting in a protrusion which will collide with the

face of the tool and may potentially destroy the tool completely. On the other hand, if the diameter of the milling cutter is too small, the core will remain inside the hole axis and must then be milled off separately.

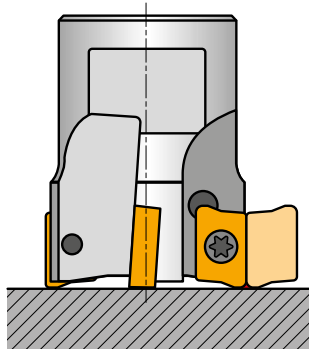
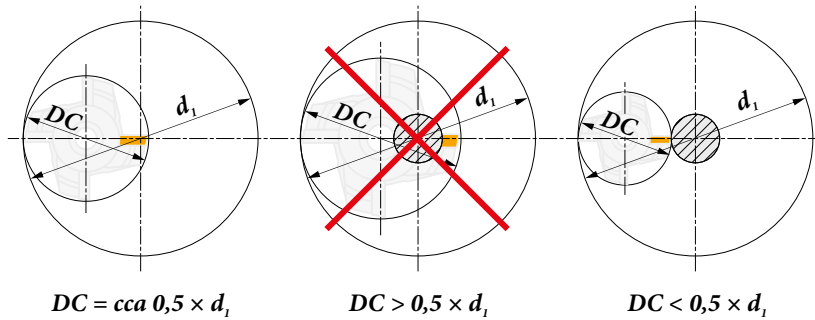

- D_{max} – Hole diameter
- DC – Milling cutter diameter
- $INSD$ – Insert diameter
- RE – Insert corner radius
- BS – WIPER edge length
- b – Max. a_e for grooving

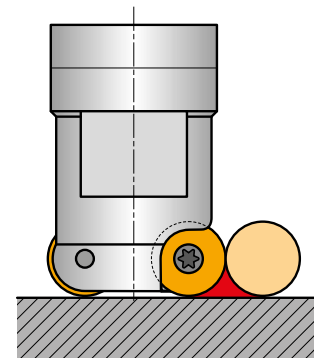

Maximum hole diameter

For blind holes, you can achieve a flat bottom by having the tool pass over the bottom's centre.

For through hole: $D_{max} = 2 \cdot DC$		For through hole: $D_{max} = 2 \cdot DC$
---	--	---







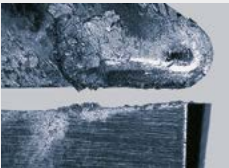

Minimum hole diameter

For through hole: $D_{min} = (DC - b) \cdot 2$		For through hole: $D_{min} = (DC - 0.8 INSD) \cdot 2$
For flat bottom: $D_{min} = (DC - (RE + BS)) \cdot 2$		For flat bottom: $D_{min} = (DC - 0.5 INSD) \cdot 2$







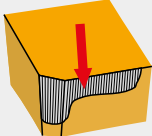
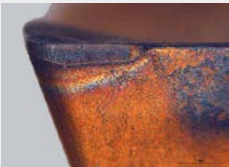

Recommendations include tables listing the minimum hole diameter, maximum hole diameter and in-axis descent angle values for these diameters (in some cases there will be two tables: one for standard insert geometry and another for HFC).

TYPES OF WEAR ON MILLING INSERTS







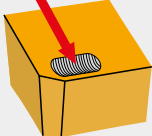

BUILT-UP EDGE

 			It has no influence.
		++	Any coating (decisive factor is anti-adhesion effect).
		↑	The higher the feed rate the less probability of built-up edge creation.
		↓↑	Change (generally increase) the cutting speed.
			It has no influence.
		↓↑	Use more positive geometry (built up edge is not created when the rake angle is more than 40°).
		-	Use a coolant with more effective anti-sticking properties (we do not recommend to use coolant for milling).

FLANK WEAR









 			Use a more wear resistant substrate (H).
		++	Any coating (decisive factor is hardness – TiC, TiCN).
		↑	Increase feed (especially if it is under 0.1 mm).
		↓	Decrease cutting speed.
			It has no influence.
		↑	Increase the clearance angle.
		+	It can help, but only with ideal working conditions.

CRATERING









 		↑	Use a more wear resistant substrate (S).
		++	CVD coating (decisive factor is oxidation resistance – α Al ₂ O ₃).
		↑	Feed has influence on shape and position of crater.
		↓	Decrease cutting speed.
		↓	Minimal effect.
		↑	Use more positive cutting geometry.
		++	It can help, but only with ideal working conditions.

TYPES OF WEAR ON MILLING INSERTS









OXIDATION GROOVE ON THE MINOR EDGE

		↑	Use a more wear resistant substrate (S).
		++	CVD coating (decisive factor is oxidation resistance – α Al ₂ O ₃).
		↓	Feed has influence on shape and position of groove.
		↓	Decrease cutting speed.
		↓	Minimal effect.
		↑	Use another (more positive) cutting geometry.
		++	It can help, but only with ideal working conditions.

PLASTIC DEFORMATION









		↑	Using a more wear resistant substrate (decisive factor is content of Co).
		+	Any coating (decisive factor is friction).
		↓	Decrease feed rate.
		↓	Decrease cutting speed.
		↓	Minimal effect.
		↑	Use another (more positive) cutting geometry.
		++	It can help, but only with ideal working conditions.

NOTCH WEAR









		↑↓	It depends on the character of the damage (abrasive – use more wear resistant substrate; breaking – use tougher substrate).
		++	CVD coating (decisive factor is oxidation resistance – α Al ₂ O ₃).
		↓	Feed has influence on intensity, but less than the cutting speed.
		↓	Decrease cutting speed.
		↑↓	Use unequal depth of cut.
		↓	Use less positive cutting geometry.
		+	It can help, but only with ideal working conditions.

TYPES OF WEAR ON MILLING INSERTS







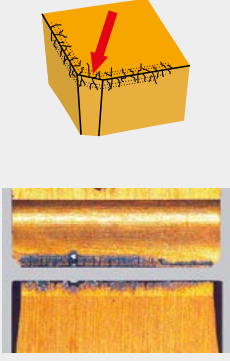

BRITTLE CRACKS AT THE CUTTING EDGE

		↓	(H) grain has a great influence.
		+	PVD coating recommended.
		↓	Feed has influence on intensity, but less than the cutting speed.
		↑↓	It is about vibrations.
		↓	It has no influence.
		↑	Increase the rake angle to reduce cutting forces.
		-	No coolant (it is possible to use air to remove chips from cutting area).

FAILURE OF CUTTING EDGE







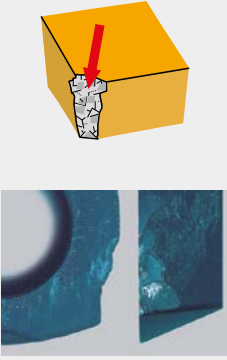

		↓	(H) grain has a great influence.
		+	PVD coating recommended.
		↑↓	Good swarf control is very important.
		↑↓	It is about swarf control and vibration.
		↑↓	Reduces the force load (important for machining with long overhangs).
		↓	Use less positive cutting geometry.
			It has no influence.

CREATION OF RACK CRACKS

		↓	(H) grain has a great influence.
		++	PVD coating recommended.
		↓	Feed has influence on intensity, but less than the cutting speed.
		↓	Lower speed means lower temperature.
			It has no influence.
		↑	Use another (more positive) cutting geometry.
		---	No coolant (it is possible to use air to remove chips from cutting area).

TYPES OF WEAR ON MILLING INSERTS

INSERT FRACTURE

		↓	(H) grain has a great influence.
		+	PVD coating recommended.
		↓	Very important to reduce cutting force.
		↑↓	It is about swarf control and vibration.
		↓	Reduces the force load.
		↓	Use less positive cutting geometry.
			It has no influence.

POOR SURFACE QUALITY

	<p>Description and cause:</p> <p>Numerous causes depending on the workpiece material, cutting conditions (feed rate and cutting speed), the condition of the cutting edge, the extent and type of wear, and the condition and rigidity of the machine – tool – workpiece assembly.</p> <ul style="list-style-type: none"> • Incorrect tool chosen • Incorrect chip thickness • Incorrect cutting speed • Coolant is needed • High feed rate 	<p>Corrective measures:</p> <ul style="list-style-type: none"> • Use a finishing insert, or an insert with finishing segment • Use an insert with suitable cutting geometry • Reduce the feed rate • Adjust (usually increase) the cutting speed • Use coolant or lubrication (MQL) • Eliminate vibrations • Use a tool with which the position of the individual inserts can be adjusted more accurately • Change the chip thickness (modify the machining conditions)
---	---	--

VIBRATIONS

<p>Description and cause:</p> <p>This is a very common problem, which is mainly caused by an unbalanced workpiece or tool, unstable fixing of the machined part and high cutting forces.</p> <ul style="list-style-type: none"> • Low rigidity of machine-tool-workpiece assembly • Excessive chip depth (both axial and radial) • Run-out – poor workpiece or tool balance • Large tool overhang 	<p>Corrective measures:</p> <ul style="list-style-type: none"> • Check the stability of the workpiece fixing • Check the stability of the tool fixing • Reduce the cutting depth • Use a tool with smaller overhang • Modify the cutting speed • Reduce the chip thickness (change the cutting or machining conditions) • Choose a suitable cutting geometry and tool material to minimize the cutting process force balance (as sharp and as positive as possible), i.e. use a tool with a lower cutting resistance • When milling, use a tool with a smaller setting angle
--	---

TYPES OF WEAR ON MILLING INSERTS

BURRS

	<p>Description and cause: This usually occurs on soft steels and plastic materials.</p>	<p>Corrective measures:</p> <ul style="list-style-type: none"> • Use a cutting insert with a sharp cutting edge • Use a cutting insert with positive geometry • Use a tool with a smaller setting angle
---	--	---

ERRORS IN DIMENSIONS AND SHAPE OF WORKPIECE

	<p>Description and cause: Depends on a number of factors.</p>	<p>Corrective measures:</p> <ul style="list-style-type: none"> • Use a wear-resistant cutting insert • Improve the stability of the cutter and workpiece • Minimize tool overhang • Use a workpiece with a suitable machining allowance
---	--	--

INADEQUATE CHIP FORMATION

	<p>Description and cause: Producing a chip with a suitable shape is very important to insert durability and service life of the tool. The workpiece material, the feed rate, the depth of cut and the cutting geometry all have an effect on chip forming. A chip that is too long is unacceptable for various reasons, while a chip that is too short is undesirable as it overloads the cutting edge and causes vibrations.</p>	<p>Corrective measures:</p> <ul style="list-style-type: none"> • Change the feed rate and depth of cut • Use a more suitable cutting geometry • Change the cutting conditions
---	--	---



TYPES OF WEAR ON MILLING INSERTS

CHECK THE SEAT CONDITION OF THE CUTTING INSERT

Before clamping a new cutting insert or changing the edge, it is necessary to clean the seat and check its condition or the condition of the anvil and wedge (especially the damage under the corner of the cutting insert).

CHECK AND SERVICE THE CLAMPING PARTS

It is also important to check the clamping parts, including clamping levers, screws, wedges and clamps. Only use original, undamaged parts (found in the catalogue). Regularly lubricate the threads and the binding surface of screws using, for example, heat-resistant lubricant (MOLYKOTE). For assembly and disassembly, only use screwdrivers and wrenches specified in our catalogue or recommended by the tool manufacturer. Be careful not to over-tighten. To avoid this, we advise using a pre-set torque wrench.

CHECK THE TIGHTENING

Before tightening, check the fit of the cutting insert on the whole of the binding surface and in the radial and axial directions. Cutting inserts and tools must always be clean and undamaged.



FORMULAS

Value	Unit	Formula
Number of revolutions	[rev/min]	$n = \frac{v_c \cdot 1000}{DC \cdot \pi}$
Cutting speed	[m/min]	$v_c = \frac{\pi \cdot DC \cdot n}{1000}$
Feed per revolution	[mm/rev]	$f_{rev} = \frac{f_{min}}{n} = f_z \cdot z$
Feed per minute (speed of feed)	[mm/min]	$f_{min} = v_f = f_{rev} \cdot n = f_z \cdot z \cdot n$
Feed per tooth	[mm/tooth]	$f_z = \frac{f_{rev}}{z} = \frac{f_{min}}{n \cdot z}$
Chip cross section	[mm ²]	$A = f_z \cdot a_p$
Chip thickness (for inserts with a straight edge)	[mm]	$h = f_z \cdot \sin \kappa_r$
Chip thickness (for round cutting inserts)	[mm]	$h = f_z \cdot \sqrt{\frac{a_p}{INSD}}$
Metal removal rate	[cm ³ /min]	$Q = \frac{a_p \cdot a_e \cdot f_{min}}{1000}$
Power demand	[kW]	$P_c = \frac{a_p \cdot a_e \cdot f_{min}}{60 \cdot 10^6 \cdot \eta} \cdot k_c \cdot k_\gamma$
Approximate power demand	[kW]	$P_c = \frac{a_p \cdot a_e \cdot f_{min}}{x}$

Note:

	Quantity	Unit
<i>n</i>	Number of revolutions	[rev/min]
<i>DC</i>	Diameter (of tool or work piece)	[mm]
<i>v_c</i>	Cutting speed	[m/min]
<i>f_{rev}</i>	Feed per revolution	[mm/rev]
<i>A</i>	Chip cross section	[mm ²]
<i>a_p</i>	Axial depth of cut (depth of cut)	[mm]
<i>a_e</i>	Radial depth of cut (width of cut)	[mm]
<i>κ_r</i>	Setting angle	[°]
<i>f_{min}</i>	Feed per minute (sometimes called speed of feed)	[mm/min]
<i>f_z</i>	Feed per tooth	[mm/tooth]
<i>z</i>	Number of teeth	[-]
<i>INSD</i>	Diameter of insert	[mm]

	Quantity	Unit
<i>h</i>	Chip thickness	[mm]
<i>Q</i>	Material removal rate per minute	[cm ³ /min]
<i>P_c</i>	Power demand	[kW]
<i>k_c</i>	Cutting force per mm ²	[MPa]
<i>k_γ</i>	Coefficient of influence of angle γ ₀	[°]
η	Machine efficiency usually η = 0,75	[-]
<i>x</i>	Coefficient of influence of work piece material	[-]

Material	Steel	Cast iron	Al
Coefficient <i>x</i>	24 000	30 000	120 000



RECOMMENDED TORQUE OF CLAMPING SCREWS

Clamping screw	Torque	Thread	Length
	[Nm]	–	[mm]
US 20	0.9	M 2	3
US 2205-T07P	0.9	M 2.2	5
US 25	1.2	M 2.5	5
US 2505-T08P	1.2	M 2.5	5
US 2506-T07P	1.2	M 2.5	6
US 3006-T09P	2	M 3	6
US 3007-T09P	2	M 3	7
US 3504-T09P	3	M 3.5	4
US 3507-T15	3	M 3.5	7
US 3509-T15	3	M 3.5	9
US 3511-T15	3	M 3.5	11
US 3512-T15P	3	M 3.5	12
US 4008-T15P	3.5	M 4	8
US 4011-T15P	3.5	M 4	11
US 4511-T20	5	M 4.5	11
US 5012-T15P	5	M 5	12
US 70	5	M 4	5
US 71	5	M 4	7
US 72	5	M 4	9
US 73	5	M 4	11
CS 3007-T08P	1.2	M 3	7
CS 4008-T15P	3	M 4	8
CS 42506-T07P	1	M 2.5	6
CS 43008-T08P	1.2	M 3	8
CS 43509-T10P	2	M 3.5	9
CS 44013-T15P	3	M 4	13
CS 45016-T20P	5	M 5	16
CS 46020-T25P	7.5	M 6	20
CS 48025-T40P	15	M 8	25
CS 5009-T20P	5	M 5	9
CS 5013-T20P	5	M 5	13
CS 5015-T20P	5	M 5	15
CS 6020-T20P	7.5	M 6	20
CS 8025-T30P	15	M 8	25
US 2505-T07P	1.2	M 2.5	5
US 2506-T07P	1.2	M 2.5	6
US 3007-T09P	2	M 3	7
US 3505-T09P	3	M 3.5	5
US 4011A-T15P	3.5	M 4	11
US 4011-T15P	3.5	M 4	11
US 44010-T15P	3.5	M 4	10
US 44012-T15P	3.5	M 4	12
US 45011-T20P	5	M 5	11
US 45012-T20P	5	M 5	12
US 5011-T20P	5	M 5	11
US 5018-T20P	5	M 5	18
US 52506-T07P	0.8	M 2.5	6
US 54511-T15P	5	M 4.5	11
US 62003A-T06P	0.6	M 2	3
US 62004A-T06P	0.6	M 2	4
US 62004-T06P	0.6	M 2	4
US 62505-T07P	1.2	M 2.5	5
US 62506-T07P	1.2	M 2.5	6
US 62506-T08P	1.2	M 2.5	6
US 62508-T08P	1.2	M 2.5	7
US 63009-T09P	1.2	M 3	9
US 63509-T15P	3	M 3.5	10
US 63510-T10P	2	M 3.5	9
US 63511D-T15P	3	M 3.5	11

Clamping screw	Torque	Thread	Length
	[Nm]	–	[mm]
US 63513-T15P	3	M 3.5	12
US 64014-T15P	3.5	M 4	14
US 65013-T20	5	M 5	13
US 65014-T20P	5	M 5	14
US 65017-T20P	5	M 5	17
US 66015-T25P	7.5	M 6	15
US 68020-T30P	15	M 8	20
US 68026-T30P	15	M 8	26
US 74016-T15P	3.5	M 4	16

Torque screwdrivers

Torque handle 	Torque [Nm]	Clamping screw thread
MR-0.8-2.0 Vario	0.5 – 2.0	M 2 – M 3
MR-1.0-5.0 Vario	0.8 – 5.0	M 2.5 – M 5
MR-0.9 fix	0.9	M 2
MR-2.0 fix	2.0	M 3
MR-3.0 fix	3.0	M 3.5
MR-3.5 fix	3.5	M 4
MR-5.0 fix	5.0	M 5

Replaceable shanks

Replaceable shanks 
D-T6
D-T6P
D-T7
D-T7P
D-T8
D-T8P
D-T9
D-T9P
D-T15
D-T15P
D-T20
D-T20P

Screw lubrication

Insert clamping screws are subject to high thermal stresses. It is recommended that all screws be lubricated with a high quality paste such as MOLYKOTE 1000.



TECHNICAL INFORMATION ON INSERT BOX

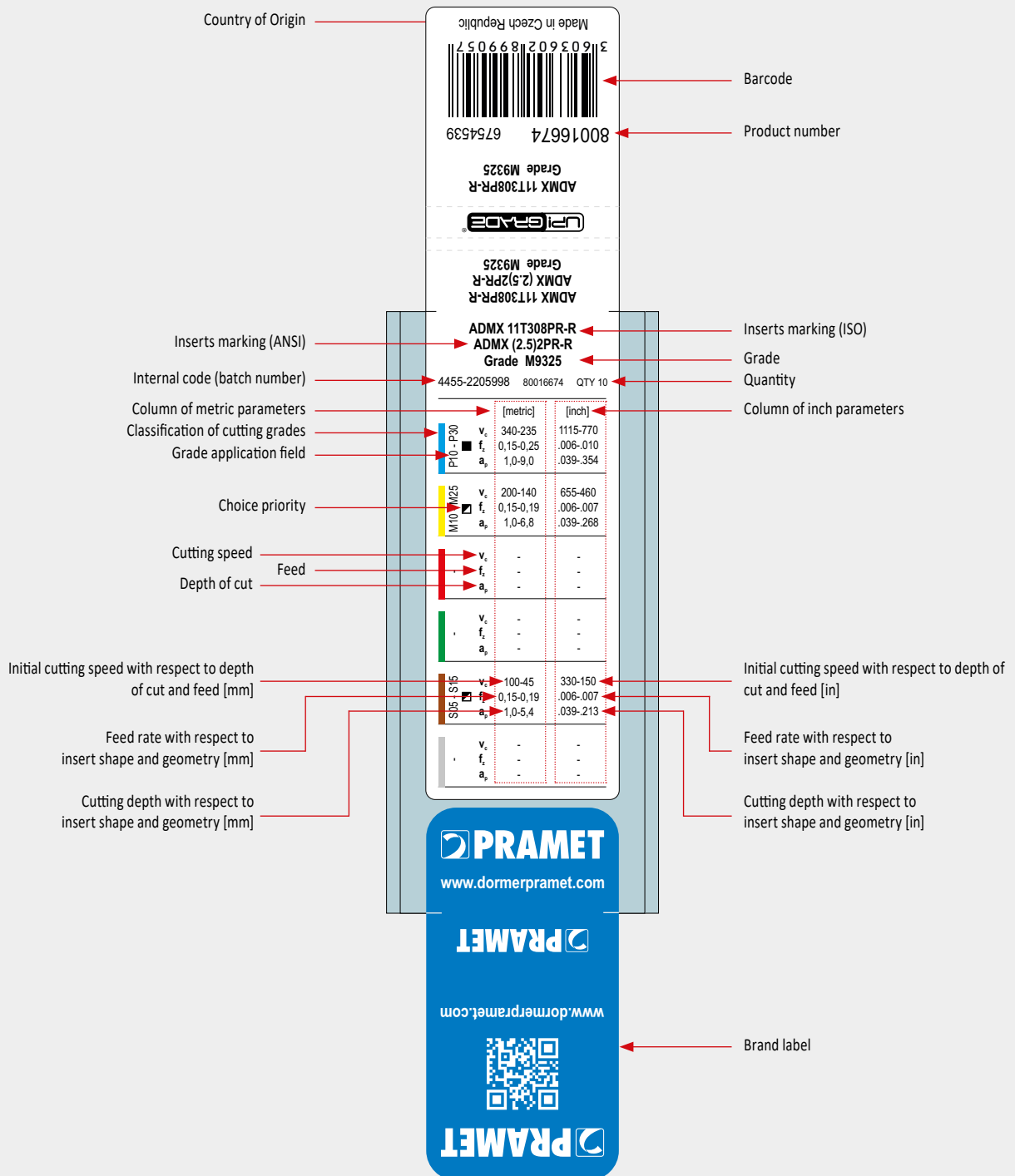



HARDNESS CONVERSION TABLE

Strength [MPa]	Hardness			
	BRINELL	VICKERS	ROCKWELL	ROCKWELL
R_m	HB	HV	HRB	HRC
285	86	90	1190	–
320	95	100	56.2	–
350	105	110	62.3	–
385	114	120	66.7	–
415	124	130	71.2	–
450	133	140	75.0	–
480	143	150	78.7	–
510	152	160	81.7	–
545	162	170	85.8	–
575	171	180	87.1	–
610	181	190	89.5	–
640	190	200	91.5	–
675	199	210	93.5	–
705	209	220	95	–
740	219	230	96.7	–
770	228	240	98.1	–
800	238	250	99.5	–
820	242	255	–	23.1
850	252	265	–	24.8
880	261	275	–	26.4
900	266	280	–	27.1
930	276	290	–	28.5
950	280	295	–	29.2
995	295	310	–	31.0
1030	304	320	–	32.2
1060	314	330	–	33.3
1095	323	340	–	34.4
1125	333	350	–	35.5
1155	342	360	–	36.6

Strength [MPa]	Hardness			
	BRINELL	VICKERS	ROCKWELL	ROCKWELL
R_m	HB	HV	HRB	HRC
1190	352	370	–	37.7
1220	361	380	–	38.8
1255	371	390	–	39.8
1290	380	400	–	40.8
1320	390	410	–	41.8
1350	399	420	–	42.7
1385	409	430	–	43.6
1420	418	440	–	44.5
1455	428	450	–	45.3
1485	437	460	–	46.1
1520	447	470	–	46.9
1555	456	480	–	47.7
1595	466	490	–	48.4
1630	475	500	–	49.1
1665	485	510	–	49.8
1700	494	520	–	50.5
1740	504	530	–	51.1
1775	513	540	–	51.7
1810	523	550	–	52.3
1845	532	560	–	53.0
1880	542	570	–	53.6
1920	551	580	–	54.1
1955	561	590	–	54.7
1995	570	600	–	55.2
2030	580	610	–	55.7
2070	589	620	–	56.3
2105	599	630	–	56.8
2145	608	640	–	57.3
2180	618	650	–	57.8





SIMPLY RELIABLE

As a professional you can judge the quality of work by just looking at the chip. Our chip is a clean and uncomplicated shape that in itself tells a story. It is a clear and consistent signal and that's why we use it as a symbol for being **Simply Reliable**.

DORMER PRAMET

Austria

T: +31 10 2080 240
info.at@dormerpramet.com

Belgium & Luxembourg

T: +32 3 440 59 01
info.be@dormerpramet.com

Brazil

T: +55 11 5660 3000
info.br@dormerpramet.com

Canada

T: (888) 336 7637
En Français: (888) 368 8457
cs.canada@dormerpramet.com

China

T: +86 21 2416 0508
info.cn@dormerpramet.com

Croatia

T: +385 98 407 489
info.hr@dormerpramet.com

Czech Republic

T: +420 583 381 111
info.cz@dormerpramet.com

Denmark

T: 808 82106
info.se@dormerpramet.com

Finland

T: 0205 44 7003
info.fi@dormerpramet.com

France

T: +33 (0)2 47 62 57 01
info.fr@dormerpramet.com

Germany

T: +49 9131 933 08 70
info.de@dormerpramet.com

Hungary

T: +36-96 / 522-846
info.hu@dormerpramet.com

India

T: +91 11 4601 5686
info.in@dormerpramet.com

Italy

T: +39 02 30 70 54 44
info.it@dormerpramet.com

Kazakhstan

T: +7 771 305 11 45
info.kz@dormerpramet.com

Mexico

T: +52 (555) 7293981
cs.mexico@dormerpramet.com

Netherlands

T: +31 10 2080 240
info.nl@dormerpramet.com

Norway

T: 800 10 113
info.se@dormerpramet.com

Poland

T: +48 32 78-15-890
info.pl@dormerpramet.com

Portugal

T: +351 21 424 54 21
info.pt@dormerpramet.com

Romania

T: +4(0)730 015 885
info.ro@dormerpramet.com

Russia

T: +7 (495) 775 10 28
info.ru@dormerpramet.com

Slovakia

T: +421 (41) 764 54 60
info.sk@dormerpramet.com

Slovenia

T: +385 98 407 489
info.si@dormerpramet.com

Spain

T: +34 935717722
info.es@dormerpramet.com

Sweden

responsible for Iceland
T: +46 35 16 52 96
info.se@dormerpramet.com

Switzerland

T: +31 10 2080 240
info.ch@dormerpramet.com

Turkey

T: +90 533 212 45 47
info.tr@dormerpramet.com

Ukraine

T: +38 067 566 38 80
T: +38 067 566 81 51
info.ua@dormerpramet.com

United Kingdom

responsible for Ireland
T: 0870 850 4466
info.uk@dormerpramet.com

United States of America

T: (800) 877-3745
cs@dormerpramet.com

Other countries

South America

T: +55 11 5660 3000
info.br@dormerpramet.com

Adria

T: +420 583 381 527
info.rcee@dormerpramet.com

Rest of the World

Dormer Pramet International UK
T: +44 1246 571338
info.int@dormerpramet.com

Dormer Pramet International CZ
T: +420 583 381 520
info.int.cz@dormerpramet.com

DP-CAT-MILLING-2021-EN

FOLLOW US...



www.dormerpramet.com



youtube.com/dormerpramet



facebook.com/dormerprametsocial



linkedin.com/company/dormerpramet



instagram.com/dormerprametsocial



twitter.com/dormerpramet